

50KC

Cooling Only/Electric Heat

Packaged Rooftop

14 SEER

3 to 5 Nominal Tons



United Technologies
turn to the experts 

Product Data

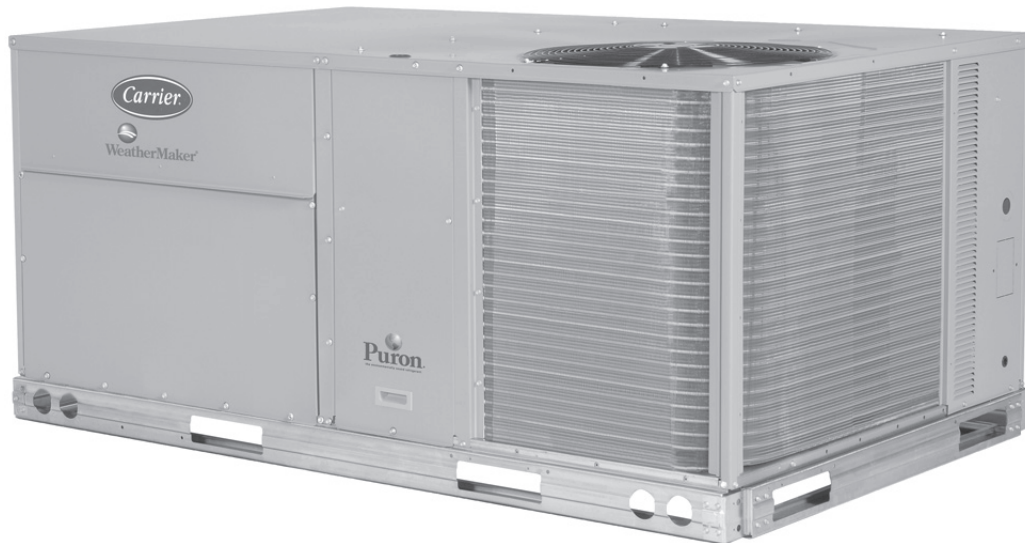

C08613



TABLE OF CONTENTS

	PAGE		PAGE
FEATURES AND BENEFITS	3	APPLICATION DATA	15
MODEL NUMBER NOMENCLATURE	4	COOLING TABLES	16
FACTORY OPTIONS & ACCESSORIES	6	STATIC PRESSURE TABLES	22
AHRI CAPACITY RATING	8	FAN PERFORMANCE	23
SOUND PERFORMANCE	8	ELECTRICAL INFORMATION	34
PHYSICAL DATA	9	SEQUENCE OF OPERATION	47
CURBS, WEIGHTS & DIMENSIONS	10	GUIDE SPECIFICATIONS	50

50KC



Turn to the Experts.™

The Carrier rooftop unit (RTU) was designed by customers for customers. With no-strip screw collars, handled access panels, and more we've made your unit easy to install, easy to maintain and easy to use.

Easy to install:

All WeatherMaker® units are field-convertible to horizontal air flow which makes it easy to adjust to unexpected job site complications. Lighter units make easy replacement. Carrier 50KC rooftops fit on existing Carrier curbs dating back to 1989. Also, our large control box gives you room to work and room to mount Carrier accessory controls.

Easy to maintain:

Easy access handles by Carrier provide quick and easy access to all normally serviced components. Our "no-strip" screw system has superior holding power and guides screws into position while preventing the screw from stripping the unit's metal. Take accurate pressure readings by reading condenser pressure with panels on. Simply remove the black, composite plug, route your gauge line(s) through the hole, and connect them to the refrigeration service valve(s).

Easy to use:

The newly designed, central terminal board by Carrier puts all your connections and troubleshooting points in one convenient place, standard. Most low voltage connections are made to the same board and make it easy to find what you're looking for and easy to access it. Carrier rooftops have high and low pressure switches, a filter drier, and 2-in (51mm) filters standard.

FEATURES AND BENEFITS

- Single-stage cooling capacity control on 04 to 06 models.
- SEER's up to 14.1.
- EER's up to 12.0
- Up to 28% lighter than similar industry units. Lighter rooftops make easier replacement jobs.
- 3-5 ton units fit on existing Carrier rooftop curbs making the utility connections the same. This saves time and money on replacement jobs.
- Standardized components and layout. Standardized components and controls make service and stocking parts easier.
- Scroll compressors on all units. This makes service, stocking parts, replacement, and troubleshooting easier.
- Field convertible airflow (3-5 tons). Being able to convert a unit from vertical airflow to horizontal makes it easy to overcome job site complications.
- Standard Direct Drive - ECM indoor motor with optional belt drive system to meet nearly all applications.
- Provisions for bottom or side condensate drain.
- Capable of thru-the-base or thru-the-curb electrical routing.
- Single-point electrical connection.
- Sloped, composite drain pan sheds water; and won't rust.
- Standardized controls and control box layout. Standardized components and controls make stocking parts and service easier.
- Clean, large, easy to use control box.
- Color-coded wiring.
- Large, laminated wiring and power wiring drawings which are affixed to unit make troubleshooting easy.
- Single, central terminal board for test and wiring connections.
- Fast-access, handled, panels for easy access to the blower and blower motor, control box, and compressors.
- "No-strip" screw system guides screws into the panel and captures them tightly without stripping the screw, the panel, or the unit.
- Exclusive, newly-design indoor refrigerant header for easier maintenance and replacement.
- Mechanical cooling (115°F to 40°F or 46°C to 4°C) standard on all models. Winter start kit allows cooling operation down to 25°F (-4°C) and MotorMaster to -20°F (-29°C).
- 2-in (51mm) disposable filters on all units.
- Refrigerant filter-drier on each circuit.
- High and low pressure switches. Added reliability with high pressure switch and low pressure switch.
- Factory-installed Humidi-MiZer® adaptive dehumidification system on all sizes with round tube/plate fin condenser coils, includes MotorMaster I controller.

MODEL NUMBER NOMENCLATURE

Position:	1	2	3	4	5	6	7	8	9	10	11	12	13	14	15	16	17	18
Example:	5	0	K	C	-	A	0	4	A	1	A	5	-	0	A	0	A	0

50KC

Unit Heat Type
50 - Electric Heat
Packaged Rooftop

Model Series - WeatherMaker®
KC - Standard 14 SEER Efficiency

Heat Options
- - No heat

Refrig. Systems Options
A = Standard One-Stage cooling models
B = Standard One-Stage cooling models with Humidi-MiZer®

Cooling Tons
04 - 3 ton
05 - 4 ton
06 - 5 ton

Sensor Options
A = None
B = RA Smoke Detector
C = SA Smoke Detector
D = RA + SA Smoke Detector
E = CO₂
F = RA Smoke Detector and CO₂
G = SA Smoke Detector and CO₂
H = RA + SA Smoke Detector and CO₂

Indoor Fan Options
0 = Direct Drive ECM
2 = Medium Static Option
3 = High Static Option

Coil Options for Round Tube/Plate Fin Condenser Coil (Outdoor - Indoor - Hail Guard)
A = Al/Cu - Al/Cu
B = Precoat Al/Cu - Al/Cu
C = E-coat Al/Cu - Al/Cu
D = E-coat Al/Cu - E-coat Al/Cu
E = Cu/Cu - Al/Cu
F = Cu/Cu - Cu/Cu
M = Al/Cu -Al/Cu — Louvered Hail Guard
N = Precoat Al/Cu - Al/Cu — Louvered Hail Guard
P = E-coat Al/Cu - Al/Cu — Louvered Hail Guard
Q = E-coat Al/Cu - E-coat Al/Cu — Louvered Hail Guard
R = Cu/Cu - Al/Cu — Louvered Hail Guard
S = Cu/Cu - Cu/Cu — Louvered Hail Guard

Factory Assigned
0 = Standard
1 = LTL

Electrical Options
A = None
C = Non-Fused Disconnect
D = Thru-The-Base Connections
F = Non-Fused Disconnect and Thru-The-Base Connections

Service Options
0 = None
1 = Unpowered Convenience Outlet
2 = Powered Convenience Outlet
3 = Hinged Panels
4 = Hinged Panels and Unpowered Convenience Outlet
5 = Hinged Panels and Powered Convenience Outlet

Intake / Exhaust Options
A = None
B = Temperature Economizer w/ Barometric Relief
F = Enthalpy Economizer w/ Barometric Relief
K = 2-Position Damper
U = Temperature Ultra Low Leak Economizer w/ Barometric Relief
W = Enthalpy Ultra Low Leak Economizer w/ Barometric Relief

Base Unit Controls
0 = Electro-mechanical Controls can be used with W7212 EconoMi\$er IV (Non-Fault Detection and Diagnostic)
1 = PremierLink Controller
2 = RTU Open Multi-Protocol Controller
6 = Electro-mechanical with W7220 Economizer controller Controls. Can be used with W7220 EconoMi\$er X (with Fault Detection and Diagnostic)

Design Revision
- = Factory Design Revision

Voltage
1 = 575/3/60
3 = 208-230/1/60
5 = 208-230/3/60
6 = 460/3/60

Note: On single phase (-3 voltage code) models, the following are not available as a factory installed option:
- Humidi-MiZer
- Coated Coils or Cu Fin Coils
- Louvered Hail Guards
- Economizer or 2 Position Damper
- Powered 115 Volt Convenience Outlet

C14250

Table 1 – FACTORY-INSTALLED OPTIONS AND FIELD-INSTALLED ACCESSORIES

CATEGORY	ITEM	FACTORY INSTALLED OPTION	FIELD INSTALLED ACCESSORY
Cabinet	Thru – the – base electrical connections	X	X
	Hinged Access Panels	X	
Coil Options	Cu/Cu indoor and/or outdoor coils ⁵	X	
	Pre – coated outdoor coils ⁵	X	
	Premium, E – coated outdoor coils ⁵	X	
Humidity Control	Humidi – MiZer Adaptive Dehumidification System ⁵	X	
Condenser Protection	Condenser coil hail guard (louvered design) ⁵	X	X
Controls	Thermostats, temperature sensors, and subbases		X
	PremierLink DDC communicating controller	X	X
	RTU Open – protocol controller	X	
	Smoke detector (supply and/or return air)	X	
	Time Guard II compressor delay control circuit		X
	Phase Monitor		X
Economizers & Outdoor Air Dampers	EconoMi\$er IV (for electro – mechanical controlled – Non FDD (Standard air leak damper models) ^{5, 6}	X	X
	EconoMi\$er2 for DDC controls, complies with FDD (Standard and Ultra Low Leak air damper models) ^{5, 7}	X	X
	Motorized 2 position outdoor – air damper ⁵	X	X
	Manual outdoor – air damper (25% and 50%)		X
	Barometric relief ¹	X	X
	Power exhaust		X
	EconoMi\$er X for electro – mechanical controls, complies with FDD (Standard and Ultra Low Leak air damper models) ^{5, 6}	X	X
Economizer Sensors & IAQ Devices	Single dry bulb temperature sensors ²	X	X
	Differential dry bulb temperature sensors ²		X
	Single enthalpy sensors ²	X	X
	Differential enthalpy sensors ²		X
	CO ₂ sensor (wall, duct, or unit mounted) ²	X	X
Electric Heat	Electric Resistance Heaters		X
	Single Point Kit		X
Indoor Motor & Drive	Multiple motor and drive packages	X	
Low Ambient Control	Winter start kit ³		X
	Motormaster® head pressure controller ³		X
Power Options	Convenience outlet (powered) ⁵	X	
	Convenience outlet (unpowered)	X	
	Non – fused disconnect ⁴	X	
Roof Curbs	Roof curb 14 – in (356mm)		X
	Roof curb 24 – in (610mm)		X

50KC

NOTES:

1. Included with economizer.
2. Sensors for optimizing economizer.
3. See application data for assistance.
4. Available on units with MOCP's of 80 amps or less.
5. Not available as factory installed option on single phase (208/230/1/60) models. Use field – installed accessory where available.
6. FDD – (Fault Detection and Diagnostic) capability per California Title 24 section 120.2
7. Models with RTU Open DDC controls comply with California Title 24 Fault Detection and Diagnostic (FDD). PremierLink is non FDD.

FACTORY OPTIONS AND/OR ACCESSORIES

Economizer

Economizers save energy, money and improve comfort levels in the conditioned space. They bring in fresh, outside air for ventilation; and provide cool outside air to cool your building. This also is the preferred method of low ambient cooling. When integrated with CO₂ sensors, economizers can provide even more savings by coupling the ventilation air to only that amount required based on space occupancy. Economizers are available, installed and tested by the factory, with either enthalpy or temperature dry-bulb inputs. There are also models for electromechanical and direct digital controllers. Additional sensors are available as accessories to optimize the economizer. Economizers include gravity controlled barometric relief that helps equalize building pressure and ambient air pressures. This can be a cost effective solution to prevent building pressurization. Economizers are available in Ultra Low Leak and standard low leak versions.

CO₂ Sensor

Improves productivity and saves money by working with the economizer to intake only the correct amount of outside air for ventilation. As occupants fill your building, the CO₂ sensor detects their presence through increasing CO₂ levels, and opens the economizer appropriately.

When the occupants leave, the CO₂ levels decrease, and the sensor appropriately closes the economizer. This intelligent control of the ventilation air, called Demand Control Ventilation (DCV) reduces the overall load on the rooftop, saving money.

Smoke Detectors

Trust the experts. Smoke detectors make your application safer and your job easier. Carrier smoke detectors immediately shut down the rooftop unit when smoke is detected. They are available, installed by the factory, for supply air, return air, or both.

Louvered Hail Guards

Sleek, louvered panels protect the condenser coil from hail damage, foreign objects, and incidental contact.

Convenience Outlet (powered or un-powered)

Reduce service and/or installation costs by including a convenience outlet in your specification. Carrier will install this service feature at our factory. Provides a convenient, 15 amp, 115v GFCI receptacle with “Wet in Use” cover. The “powered” option allows the installer to power the outlet from the line side of the disconnect or load side as required by code. The “unpowered” option is to be powered from a separate 115/120v power source.

Non-fused Disconnect

This OSHA-compliant, factory-installed, safety switch allows a service technician to locally secure power to the rooftop.

Power Exhaust with Barometric Relief

Superior internal building pressure control. This field-installed accessory may eliminate the need for costly, external pressure control fans.

PremierLink, DDC Controller

This CCN controller regulates your rooftop’s performance to tighter tolerances and expanded limits, as well as facilitates zoning systems and digital accessories. It also unites your Carrier HVAC equipment together on one, coherent CCN network. The PremierLink can be factory-installed, or easily field-installed.

RTU Open, Multi-protocol Controller

Connect the rooftop to an existing BAS without needing complicated translators or adapter modules using the RTU Open controller. This new controller speaks the 4 most common building automation system languages (Bacnet, Modbus, N2, and Lonworks). Use this controller when you have an existing BAS.

Time Guard II Control Circuit

This accessory protects your compressor by preventing short-cycling in the event of some other failure, prevents the compressor from restarting for 30 seconds after stopping. Not required with PremierLink, RTU Open, or authorized commercial thermostats.

Filter or Fan Status Switches

Use these differential pressure switches to detect a filter clog or indoor fan motor failure. When used in conjunction with a compatible unit controller/thermostat, the switches will activate an alarm to warn the appropriate personnel.

Motorized 2-Position Damper

The new Carrier 2-position, motorized outdoor air damper admits up to 100% outside air. Using reliable, gear-driven technology, the 2-position damper opens to allow ventilation air and closes when the rooftop stops, stopping unwanted infiltration.

Manual OA Damper

Manual outdoor air dampers are an economical way to bring in ventilation air. The dampers are available in 25% and 50% versions.

FACTORY OPTIONS AND/OR ACCESSORIES (cont.)

Optional Humidi-MiZer Adaptive Dehumidification System

Carrier's Humidi-MiZer adaptive dehumidification system is an all-inclusive factory-installed option that can be ordered with any WeatherMaker 50KC-B04-06 rooftop unit.

This system expands the envelope of operation of Carrier's WeatherMaker rooftop products to provide unprecedented flexibility to meet year-round comfort conditions.

The Humidi-MiZer adaptive dehumidification system has the industry's only dual dehumidification mode setting. The Humidi-MiZer system includes two new modes of operation.

The WeatherMaker 50KC-B04-06 rooftop coupled with the Humidi-MiZer system is capable of operating in normal design cooling mode, subcooling mode, and hot gas reheat mode. Normal design cooling mode is when the unit will operate under its normal sequence of operation by cycling compressors to maintain comfort conditions.

Subcooling mode will operate to satisfy part load type conditions when the space requires combined sensible and a higher proportion of latent load control. Hot Gas Reheat mode will operate when outdoor temperatures diminish and the need for latent capacity is required for sole humidity control. Hot Gas Reheat mode will provide neutral air for maximum dehumidification operation.

Motormaster Head Pressure Controller

The Motormaster motor controller is a low ambient, head pressure controller kit that is designed to maintain the unit's condenser head pressure during periods of low ambient cooling operation. This device should be used as an alternative to economizer free cooling when economizer usage is either not appropriate or desired. The Motormaster will either cycle the outdoor fan motors or operate them at reduced speed to maintain the unit operation, depending on the model.

Hinged Access Panels

Allows access to unit's major components with specifically designed hinged access panels. Panels are: filters, control box, fan motor and compressor.

Winter Start Kit

The winter start kit by Carrier extends the low ambient limit of your rooftop to 25°F (-4°C). The kit bypasses the low pressure switch, preventing nuisance tripping of the low pressure switch. Other low ambient precautions may still be prudent.

Alternate Motors and Drives

Some applications need larger horsepower motors, some need more airflow, and some need both. Regardless of the case, your Carrier expert has a factory installed combination to meet your application. A wide selection of motors and pulleys (drives) are available, factory installed, to handle nearly any application.

Thru-the-Base Connections

Thru-the-base connections, available as either an accessory or as a factory option, are necessary to ensure proper connection and seal when routing wire and piping through the rooftop's basepan and curb. These couplings eliminate roof penetration and should be considered for gas lines, main power lines, as well as control power.

Electric Heaters

Carrier offers a full-line of field-installed accessory heaters. The heaters are very easy to use, install and are all pre-engineered and certified.

Table 2 – AHRI COOLING RATING TABLES

UNIT	COOLING STAGES	NOM. CAPACITY (TONS)	NET COOLING CAPACITY (MBH)	TOTAL POWER (KW)	SEER	EER
50KC-*04	1	3	35.4	3.0	14.0	12.00
50KC-*05	1	4	47.5	4.0	14.0	12.00
50KC-*06	1	5	58.5	4.9	14.1	12.00

LEGEND

- AHRI – Air Conditioning, Heating and Refrigeration Institute
- ASHRAE – American Society of Heating, Refrigerating and Air Conditioning, Inc.
- EER – Energy Efficiency Ratio
- SEER – Seasonal Energy Efficiency Ratio

NOTES

1. Rated and certified under AHRI Standard 210/240.
2. Ratings are based on:
Cooling Standard: 80°F (27°C) db, 67°F (19°C) wb indoor air temp and 95°F db outdoor air temp.
3. All 50KC units comply with ASHRAE 90.1 and Department of Energy (DOE) Energy Standard for minimum SEER and EER requirements.
4. 50KC units comply with US Energy Policy Act (2005). To evaluate code compliance requirements, refer to state and local codes.

50KC



Use of the AHRI Certified TM Mark indicates a manufacturer's participation in the program. For verification of certification for individual products, go to www.ahridirectory.org.



Table 3 – MINIMUM - MAXIMUM AIRFLOWS COOLING AND ELECTRIC HEAT

UNIT	COOLING		ELECTRIC HEATERS	
	Minimum	Maximum	Minimum	Maximum
50KC-*04	900	1500	900	1500
50KC-*05	1200	2000	1200	2000
50KC-*06	1500	2500	1500	2500

Table 4 – SOUND PERFORMANCE TABLE

UNIT	COOLING STAGES	OUTDOOR SOUND (dB) @60HZ								
		A-WEIGHTED	63	125	250	500	1000	2000	4000	8000
50KC-*04	1	76	78.2	78.0	74.2	73.3	70.6	66.0	62.4	56.9
50KC-*05	1	81	90.9	84.6	79.5	77.9	76.5	71.1	66.9	62.5
50KC-*06	1	77	87.5	82.5	76.1	73.6	71.3	67.1	64.1	60.0

LEGEND

dB – Decibel

NOTES:

1. Outdoor sound data is measure in accordance with AHRI standard 270.
2. Measurements are expressed in terms of sound power. Do not compare these values to sound pressure values because sound pressure accounts for specific environmental factors which do not match individual applications. Sound power values are independent of the environment and therefore more accurate.
3. A-weighted sound ratings filter out very high and very low frequencies, to better approximate the response of an "average" human ear. A-weighted measurements for Carrier units are taken in accordance with 270.



Table 5 – PHYSICAL DATA

(COOLING)

3 - 6 TONS

		50KC –A/B04	50KC –A/B05	50KC –A/B06
Refrigeration System				
	# Circuits / # Comp. / Type	1 / 1 / Scroll	1 / 1 / Scroll	1 / 1 / Scroll
	Puron® refrig. (R-410A) 1 phase (lbs-oz)	7-2	10-8	16-0
	Puron® refrig. (R-410A) 3 phase (lbs-oz)	7-2	10-8	14-8
	Humidi-MiZer Puron® refrig. charge (lbs - oz)	10-6	15-5	26-0
	Metering Device (A)	Acutrol	Acutrol	Acutrol
	Humidi-MiZer Metering Device (B)	Acutrol + TXV	Acutrol + TXV	Acutrol + TXV
	High-press. Trip / Reset (psig)	630 / 505	630 / 505	630 / 505
	Low-press. Trip / Reset (psig)	54 / 117	54 / 117	54 / 117
	Compressor Capacity Staging (%)	100%	100%	100%
Evap. Coil				
	Material (Tube/Fin)	Cu / Al	Cu / Al	Cu / Al
	Coil type	3/8-in RTPPF	3/8-in RTPPF	3/8-in RTPPF
	Rows / FPI	3 / 15	3 / 15	4 / 15
	Total Face Area (ft ²)	5.5	5.5	7.3
	Condensate Drain Conn. Size	3/4-in	3/4-in	3/4-in
Humidi-MiZer® Coil				
	Material (Tube/Fin)	Cu / Al	Cu / Al	Cu / Al
	Coil type	3/8-in RTPPF	3/8-in RTPPF	3/8-in RTPPF
	Rows / FPI	1 / 17	2 / 17	2 / 17
	Total Face Area (ft ²)	3.9	3.9	5.2
Evap. Fan and Motor				
Standard Static 1 phase	Motor Qty / Drive Type	1 / Direct	1 / Direct	1 / Direct
	Max BHP	1	1	1
	RPM Range	600-1200	600-1200	600-1200
	Motor Frame Size	48	48	48
	Fan Qty / Type	1 / Centrifugal	1 / Centrifugal	1 / Centrifugal
	Fan Diameter (in)	10 x 10	10 x 10	10 x 10
Medium Static 1 phase	Motor Qty / Drive Type	1 / Belt	1 / Belt	1 / Belt
	Max BHP	1.2	1.2	1.5
	RPM Range	770-1175	770-1175	1035-1466
	Motor Frame Size	48	48	56
	Fan Qty / Type	1 / Centrifugal	1 / Centrifugal	1 / Centrifugal
	Fan Diameter (in)	10 x 10	10 x 10	10 x 10
High Static 1 phase	Motor Qty / Drive Type	1 / Belt	1 / Belt	N/A
	Max BHP	1.5	1.5	N/A
	RPM Range	1035-1466	1035-1466	N/A
	Motor Frame Size	56	56	N/A
	Fan Qty / Type	1 / Centrifugal	1 / Centrifugal	N/A
	Fan Diameter (in)	10 x 10	10 x 10	N/A
Standard Static 3 phase	Motor Qty / Drive Type	1 / Direct	1 / Direct	1 / Direct
	Max BHP	1	1	1
	RPM Range	600-1200	600-1200	600-1200
	Motor Frame Size	48	48	48
	Fan Qty / Type	1 / Centrifugal	1 / Centrifugal	1 / Centrifugal
	Fan Diameter (in)	10 x 10	10 x 10	11 x 10
Medium Static 3 phase	Motor Qty / Drive Type	1 / Belt	1 / Belt	1 / Belt
	Max BHP	1.7	1.7	2.9
	RPM Range	770-1175	920-1303	1035-1466
	Motor Frame Size	48	56	56
	Fan Qty / Type	1 / Centrifugal	1 / Centrifugal	1 / Centrifugal
	Fan Diameter (in)	10 x 10	10 x 10	10 x 10
High Static 3 phase	Motor Qty / Drive Type	1 / Belt	1 / Belt	1 / Belt
	Max BHP	2.9	2.9	2.9
	RPM Range	1035-1466	1208-1639	1303-1687
	Motor Frame Size	56	56	56
	Fan Qty / Type	1 / Centrifugal	1 / Centrifugal	1 / Centrifugal
	Fan Diameter (in)	10 x 10	10 x 10	10 x 10
Cond. Coil 1 phase				
	Material (Tube/Fin)	Cu / Al	Cu / Al	Cu / Al
	Coil type	3/8-in RTPPF	3/8-in RTPPF	3/8-in RTPPF
	Rows / FPI	1 / 17	2 / 17	2 / 17
	Total Face Area (ft ²)	16.5	16.5	21.3
3 phase				
	Material (Tube/Fin)	Cu / Al	Cu / Al	Cu / Al
	Coil type	3/8-in RTPPF	3/8-in RTPPF	3/8-in RTPPF
	Rows..Fins/in.	1 / 17	2 / 17	2 / 17
	Total Face Area (ft ²)	16.5	14.6	18.8
Cond. fan / motor				
	Qty / Motor Drive Type	1/ Direct	1/ Direct	1/ Direct
	Motor HP / RPM	1/8 / 825	1/4 / 1100	1/4 / 1100
	Fan diameter (in)	22	22	22
Filters				
	RA Filter # / Size (in)	2 / 16 x 25 x 2	2 / 16 x 25 x 2	4 / 16 x 25 x 2
	OA inlet screen # / Size (in)	1 / 20 x 24 x 1	1 / 20 x 24 x 1	1 / 20 x 24 x 1

50KC

N/A – Not Available

CURBS, WEIGHTS & DIMENSIONS

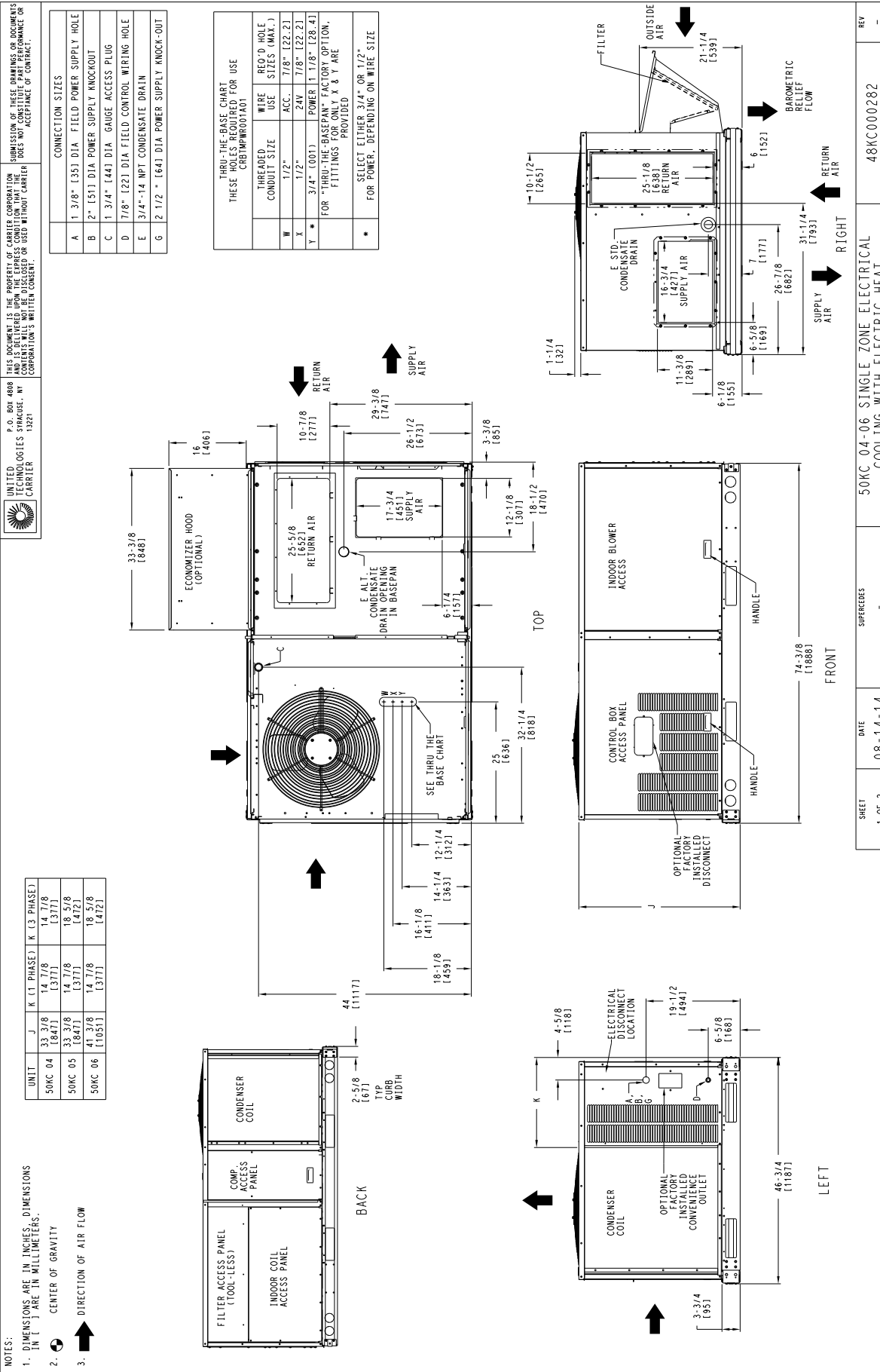

Fig. 1 - Dimensions 50KC 04-06 (sheet 1 of 2)

CURBS, WEIGHTS & DIMENSIONS (cont.)

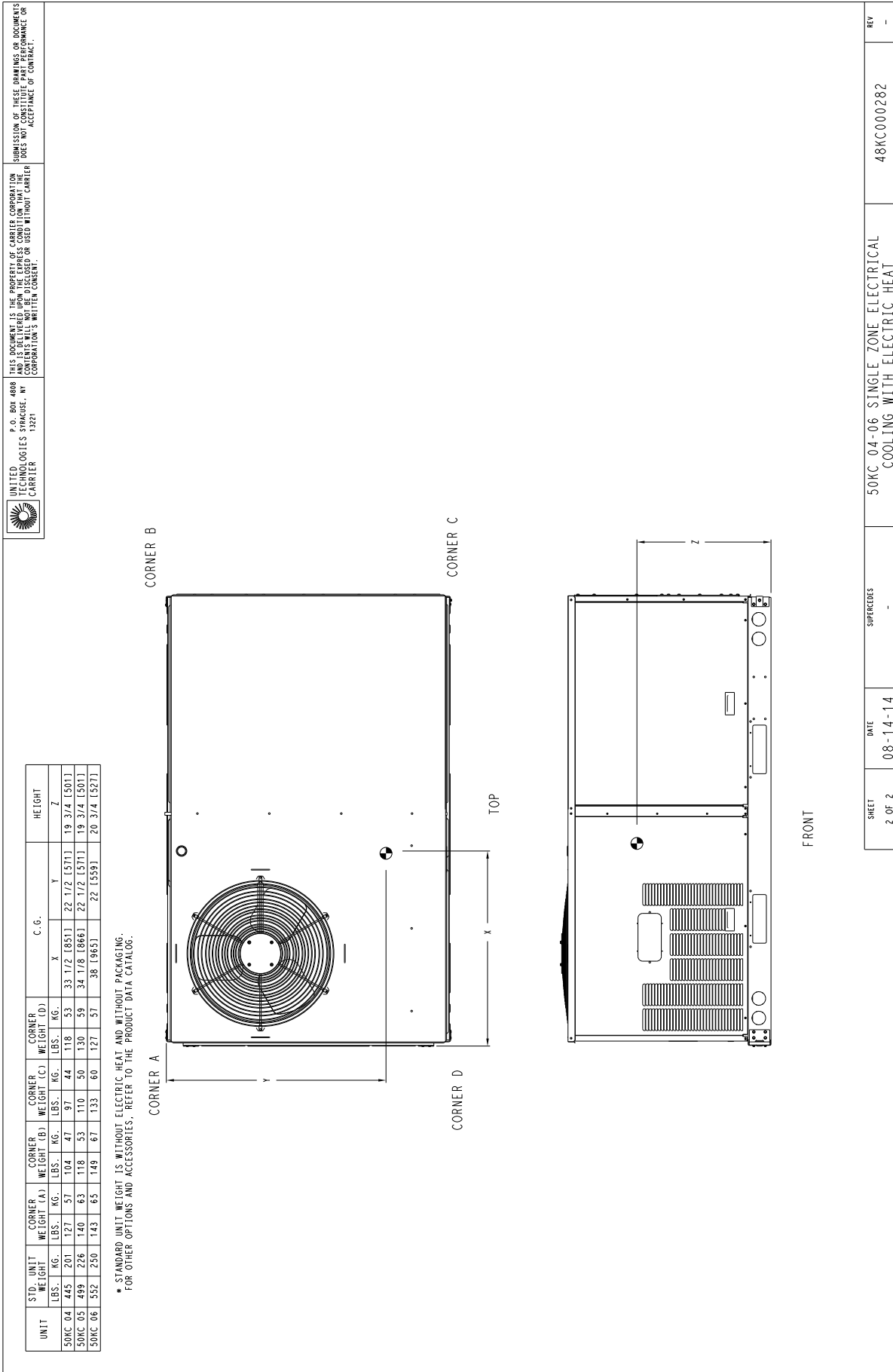
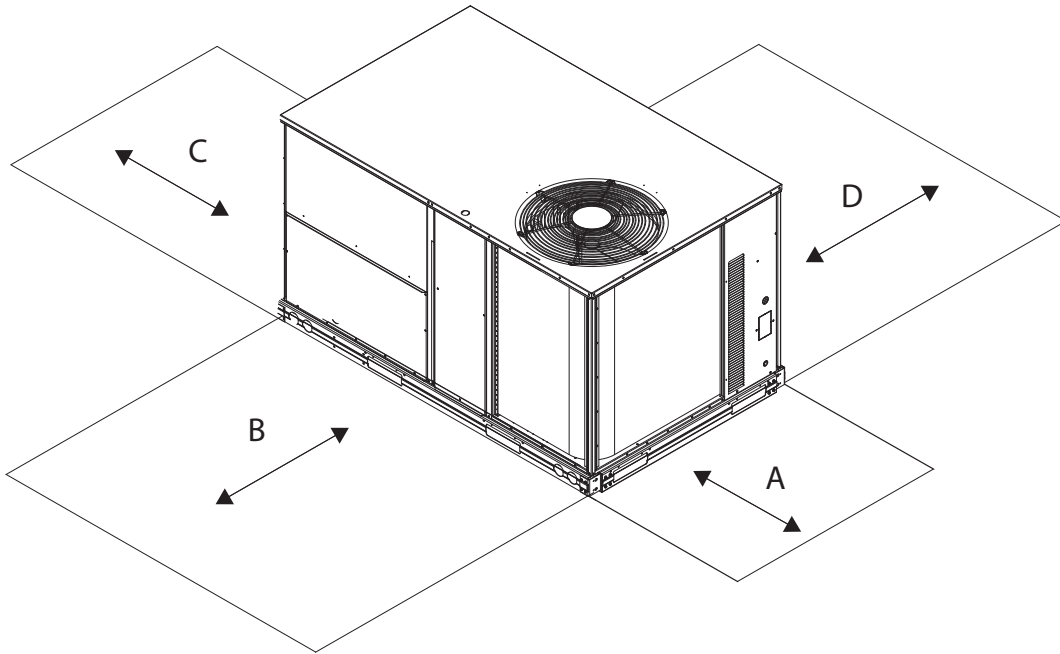

Fig. 2 - Dimensions 50KC 04-06 (sheet 2 of 2)

50KC

CURBS, WEIGHTS & DIMENSIONS (cont.)



50KC

C08337

LOCATION	DIMENSION	CONDITION
A	48-in (1219 mm) 18-in (457 mm) 18-in (457 mm) 12-in (305 mm)	Unit disconnect is mounted on panel No disconnect, convenience outlet option Recommended service clearance Minimum clearance
B	42-in (1067 mm) 36-in (914 mm) Special	Surface behind servicer is grounded (e.g., metal, masonry wall) Surface behind servicer is electrically non-conductive (e.g., wood, fiberglass) Check sources of flue products within 10-ft of unit fresh air intake hood
C	36-in (914 mm) 18-in (457 mm)	Side condensate drain is used Minimum clearance
D	42-in (1067 mm) 36-in (914 mm) Special	Surface behind servicer is grounded (e.g., metal, masonry wall, another unit) Surface behind servicer is electrically non-conductive (e.g., wood, fiberglass) Check for adjacent units or building fresh air intakes within 10-ft (3 m) of this unit's flue outlet

NOTE: Unit not designed to have overhead obstruction. Contact Application Engineering for guidance on any application planning overhead obstruction or for vertical clearances.

Fig. 3 - Service Clearance

CURBS, WEIGHTS & DIMENSIONS (cont.)

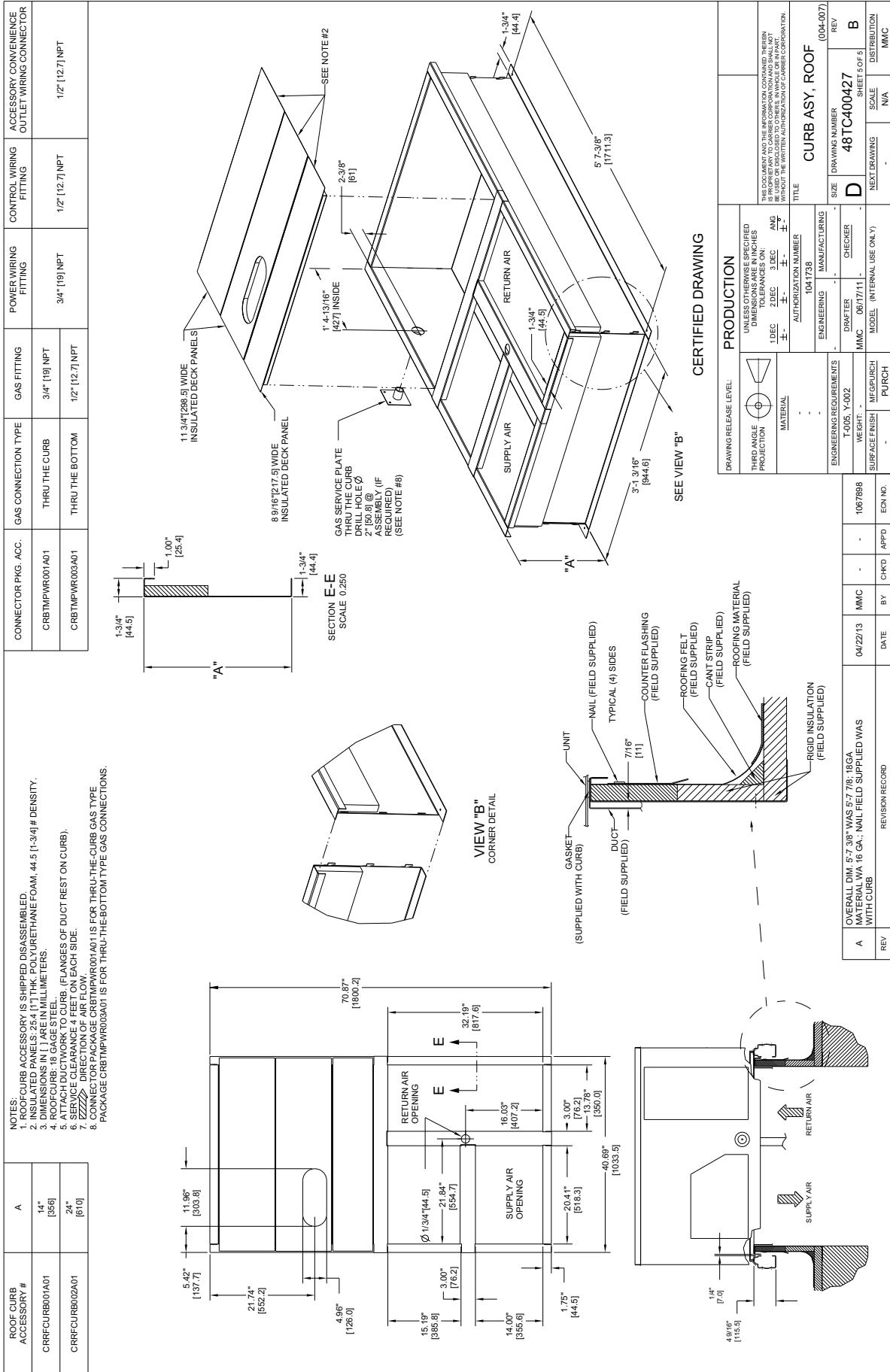

Fig. 4 - Roof Curb Details 50KC 04-06

50KC

OPTION / ACCESSORY WEIGHTS

OPTION / ACCESSORY	OPTION / ACCESSORY WEIGHTS					
	04		05		06	
	lb	kg	lb	kg	lb	kg
Humidi-MiZer ¹	50	23	50	23	55	25
Power Exhaust – vertical	45	20	45	20	45	20
Power Exhaust – horizontal	30	14	30	14	30	14
EconoMi\$er (IV, X or 2)	35	16	35	16	35	16
Two Position damper	39	18	39	18	39	18
Manual Dampers	12	5	12	5	12	5
Hail Guard (louvered)	13	6	13	6	17	8
Cu/Cu Condenser Coi ²	37	17	74	34	95	43
Cu/Cu Condenser and Evaporator Coils ²	75	34	112	51	165	75
Roof Curb (14-in. curb)	115	52	115	52	115	52
Roof Curb (24-in. curb)	197	89	197	89	197	89
CO ₂ sensor	2	1	2	1	2	1
Electric Heater	10	5	12	5	12	5
Single Point Kit	10	5	10	5	10	5
Optional Indoor Motor/Drive	6	3	6	3	17	8
Motor Master Controller	9	4	9	4	9	4
Return Smoke Detector	7	3	7	3	7	3
Supply Smoke Detector	7	3	7	3	7	3
Non – Fused Disconnect	5	2	5	2	5	2
Powered Convenience outlet	36	16	36	16	36	16
Non – Powered Convenience outlet	4	2	4	2	4	2
Enthalpy Sensor	2	1	2	1	2	1
Differential Enthalpy Sensor	3	1	3	1	3	1

NOTE: Where multiple variations are available, the heaviest combination is listed.

– Not Available

¹ For Humidi-MiZer add MotorMaster Controller.

² Where available.

APPLICATION DATA

Min operating ambient temp (cooling):

In mechanical cooling mode, your Carrier rooftop can safely operate down to an outdoor ambient temperature of 40°F (4°C) and 25°F (-4°C), with an accessory winter start kit. It is possible to provide cooling at lower outdoor ambient temperatures by using less outside air, economizers, and/or accessory low ambient kits.

Max operating ambient temp (cooling):

The maximum operating ambient temperature for cooling mode is 115°F (46°C). While cooling operation above 115°F (46°C) may be possible, it could cause either a reduction in performance, reliability, or a protective action by the unit's internal safety devices.

Min and max airflow (cooling mode):

To maintain safe and reliable operation of your rooftop, operate within the cooling airflow limits. Operating above the max may cause blow-off, undesired airflow noise, or airflow related problems with the rooftop unit. Operating below the min may cause problems with coil freeze-up.

Airflow:

All units are draw-through in cooling mode.

Outdoor air application strategies:

Economizers reduce operating expenses and compressor run time by providing a free source of cooling and a means of ventilation to match application changing needs. In fact, they should be considered for most applications. Also, consider the various economizer control methods and their benefits, as well as sensors required to accomplish your application goals. Please contact your local Carrier representative for assistance.

Motor limits, Brake horsepower (BHP):

Due to Carrier's internal unit design, air path, and specially designed motors, the full horsepower (maximum continuous BHP) band, as listed in the Physical Data table, can be used with the utmost confidence. There is no need for extra safety factors, as Carrier's motors are designed and rigorously tested to use the entire, listed BHP range without either nuisance tripping or premature motor failure.

Sizing a rooftop

Bigger isn't necessarily better. While an air conditioner needs to have enough capacity to meet the load, it doesn't need excess capacity. In fact, having excess capacity typically results in very poor part load performance and humidity control.

Using higher design temperatures than ASHRAE recommends for your location, adding "safety factors" to the calculated load, and rounding up to the next largest unit, are all signs of oversizing air conditioners. Oversizing can cause short-cycling, and short cycling leads to poor humidity control, reduced efficiency, higher utility bills, drastic indoor temperature swings, excessive noise, and increased wear and tear on the air conditioner.

Rather than oversizing an air conditioner, wise contractors and engineers "right-size" or even slightly undersize air conditioners. Correctly sizing an air conditioner controls humidity better; promotes efficiency; reduces utility bills; extends equipment life, and maintains even, comfortable temperatures. Please contact your local Carrier representative for assistance.

Low ambient applications

When equipped with a Carrier economizer, your rooftop unit can cool your space by bringing in fresh, cool outside air. In fact, when so equipped, accessory low ambient kit may not be necessary. In low ambient conditions, unless the outdoor air is excessively humid or contaminated, economizer-based "free cooling" is the preferred less costly and energy conscious method.

In low ambient applications where outside air might not be desired (such as contaminated or excessively humid outdoor environments), your Carrier rooftop can operate at ambient temperatures down to -20°F (-29°C) using the recommended accessory Motormaster low ambient controller.

Winter start

Carrier's winter start kit extends the low ambient limit of your rooftop to 25°F (-4°C). The kit bypasses the low pressure switch, preventing nuisance tripping of the low pressure switch. Other low ambient precautions may still be prudent.

Table 6 – COOLING CAPACITIES

1-STAGE COOLING

3 TONS

50KC

50KC*A04				Ambient Temperature											
				85			95			105			115		
				EA (dB)			EA (dB)			EA (dB)			EA (dB)		
				75	80	85	75	80	85	75	80	85	75	80	85
900 Cfm	EAT (wb)	58	TC	28.7	28.7	32.6	25.1	25.1	28.6	22.2	22.2	25.3	19.5	19.5	22.2
			SHC	24.8	28.7	32.6	21.7	25.1	28.6	19.1	22.2	25.3	16.7	19.5	22.2
		62	TC	31.8	31.8	32.4	26.0	26.0	29.5	22.3	22.3	26.4	19.5	19.5	23.2
			SHC	23.3	27.9	32.4	20.6	25.0	29.5	18.1	22.3	26.4	15.8	19.5	23.2
		67	TC	36.5	36.5	36.5	34.2	34.2	34.2	29.2	29.2	29.2	23.7	23.7	23.7
			SHC	19.4	24.0	28.5	18.4	22.9	27.4	16.2	20.8	25.3	14.1	18.6	23.1
		72	TC	40.3	40.3	40.3	38.2	38.2	38.2	35.6	35.6	35.6	32.4	32.4	32.4
			SHC	14.9	19.5	24.1	13.9	18.5	23.1	12.9	17.4	22.0	11.6	16.2	20.7
		76	TC	-	43.1	43.1	-	41.0	41.0	-	38.6	38.6	-	35.9	35.9
			SHC	-	15.7	20.6	-	14.8	19.8	-	13.9	18.8	-	12.8	17.6
1050 Cfm	EAT (wb)	58	TC	31.8	31.8	36.2	28.3	28.3	32.1	24.9	24.9	28.4	21.9	21.9	24.9
			SHC	27.5	31.8	36.2	24.4	28.3	32.1	21.5	24.9	28.4	18.8	21.9	24.9
		62	TC	33.8	33.8	36.1	28.9	28.9	33.4	25.0	25.0	29.6	21.9	21.9	26.0
			SHC	25.7	30.9	36.1	23.2	28.3	33.4	20.4	25.0	29.6	17.8	21.9	26.0
		67	TC	37.8	37.8	37.8	35.5	35.5	35.5	31.7	31.7	31.7	25.8	25.8	26.2
			SHC	20.7	25.9	31.1	19.7	24.9	30.1	18.1	23.3	28.6	15.8	21.0	26.2
		72	TC	41.5	41.5	41.5	39.3	39.3	39.3	36.8	36.8	36.8	33.6	33.6	33.6
			SHC	15.4	20.6	25.8	14.5	19.7	24.9	13.5	18.7	23.9	12.2	17.5	22.7
		76	TC	-	44.2	44.2	-	42.0	42.0	-	39.6	39.6	-	36.9	36.9
			SHC	-	16.4	22.1	-	15.5	21.1	-	14.5	20.0	-	13.5	18.9
1200 Cfm	EAT (wb)	58	TC	34.1	34.1	38.8	31.3	31.3	35.6	27.5	27.5	31.2	24.1	24.1	27.4
			SHC	29.5	34.1	38.8	27.0	31.3	35.6	23.7	27.5	31.2	20.7	24.1	27.4
		62	TC	34.9	34.9	39.1	32.9	32.9	35.5	27.5	27.5	32.6	24.1	24.1	28.6
			SHC	27.5	33.3	39.1	25.2	30.3	35.5	22.5	27.5	32.6	19.6	24.1	28.6
		67	TC	38.8	38.8	38.8	36.4	36.4	36.4	33.3	33.3	33.3	27.7	27.7	29.2
			SHC	21.9	27.7	33.5	20.9	26.7	32.6	19.6	25.5	31.4	17.4	23.3	29.2
		72	TC	42.4	42.4	42.4	40.1	40.1	40.1	37.7	37.7	37.7	34.5	34.5	34.5
			SHC	15.8	21.6	27.4	14.9	20.7	26.5	13.9	19.8	25.6	12.7	18.7	24.6
		76	TC	-	44.9	44.9	-	42.7	42.7	-	40.3	40.3	-	37.7	37.7
			SHC	-	16.8	23.1	-	15.9	22.1	-	15.0	21.1	-	14.0	20.1
1350 Cfm	EAT (wb)	58	TC	35.6	35.6	40.4	33.6	33.6	38.1	29.8	29.8	33.9	26.2	26.2	29.8
			SHC	30.8	35.6	40.4	29.0	33.6	38.1	25.7	29.8	33.9	22.5	26.2	29.8
		62	TC	36.3	36.3	39.9	33.7	33.7	39.7	29.9	29.9	35.3	26.2	26.2	31.0
			SHC	28.2	34.1	39.9	27.6	33.7	39.7	24.4	29.9	35.3	21.4	26.2	31.0
		67	TC	39.5	39.5	39.5	37.2	37.2	37.2	34.0	34.0	34.0	29.3	29.3	32.0
			SHC	22.9	29.4	35.8	22.0	28.5	34.9	20.8	27.3	33.9	18.9	25.4	32.0
		72	TC	43.0	43.0	43.0	40.7	40.7	40.7	38.3	38.3	38.3	35.2	35.2	35.2
			SHC	16.2	22.5	28.9	15.3	21.7	28.1	14.3	20.8	27.2	13.2	19.7	26.3
		76	TC	-	45.5	45.5	-	43.3	43.3	-	40.8	40.8	-	38.1	38.1
			SHC	-	17.3	24.0	-	16.4	23.1	-	15.4	22.1	-	14.5	21.1
1500 Cfm	EAT (wb)	58	TC	36.8	36.8	41.8	34.8	34.8	39.5	32.0	32.0	36.4	28.1	28.1	31.9
			SHC	31.9	36.8	41.8	30.1	34.8	39.5	27.7	32.0	36.4	24.2	28.1	31.9
		62	TC	36.9	36.9	43.5	35.4	35.4	38.8	32.1	32.1	37.9	28.1	28.1	33.3
			SHC	30.2	36.9	43.5	27.4	33.1	38.8	26.2	32.1	37.9	22.9	28.1	33.3
		67	TC	40.1	40.1	40.1	37.7	37.7	37.7	34.7	34.7	36.2	30.7	30.7	34.6
			SHC	23.9	31.0	38.0	23.0	30.1	37.2	21.9	29.0	36.2	20.3	27.5	34.6
		72	TC	43.6	43.6	43.6	41.3	41.3	41.3	38.7	38.7	38.7	35.7	35.7	35.7
			SHC	16.5	23.4	30.2	15.6	22.5	29.5	14.7	21.7	28.6	13.6	20.8	27.9
		76	TC	-	46.0	46.0	-	43.7	43.7	-	41.2	41.2	-	38.5	38.5
			SHC	-	17.6	24.8	-	16.7	23.9	-	15.8	22.9	-	14.8	22.0

LEGEND:

- Do not operate
- Cfm - Cubic feet per minute (supply air)
- EAT(db) - Entering air temperature (dry bulb)
- EAT(wb) - Entering air temperature (wet bulb)
- SHC - Sensible heat capacity
- TC - Total capacity

50KC*B04 (3 TONS) – UNIT WITH HUMIDI-MIZER SYSTEM IN SUBCOOLING MODE										
TEMP (F) AIR ENT CONDENSER (Edb)		AIR ENTERING EVAPORATOR – SCFM								
		900			1200			1500		
		Air Entering Evaporator – Ewb (F)								
		72	67	62	72	67	62	72	67	62
75	TC	30.9	32.0	31.9	30.7	33.5	34.3	34.8	31.8	27.6
	SHC	15.1	20.0	26.3	25.1	20.4	15.4	14.0	18.2	21.9
	kW	2.51	2.49	2.42	2.82	2.74	2.68	3.09	3.01	2.88
85	TC	32.8	28.4	23.4	18.7	23.8	29.3	24.5	18.8	13.6
	SHC	11.0	14.6	17.9	13.4	10.3	7.1	2.6	5.6	8.6
	kW	3.36	3.23	3.06	3.62	3.41	3.24	3.79	3.58	3.39
95	TC	31.3	32.0	31.9	30.7	33.5	34.3	34.8	31.8	27.6
	SHC	15.3	20.0	26.3	25.1	20.4	15.4	14.0	18.2	21.9
	kW	2.53	2.49	2.41	2.82	2.74	2.68	3.09	3.01	2.88
105	TC	32.8	28.4	23.4	18.7	23.8	29.3	24.5	18.8	13.6
	SHC	11.0	14.6	17.9	13.4	10.3	7.1	2.6	5.6	8.6
	kW	3.36	3.23	3.06	3.62	3.41	3.24	3.79	3.58	3.39
115	TC	31.3	32.0	31.9	30.7	33.5	34.3	34.8	31.8	27.6
	SHC	15.3	20.0	26.3	25.1	20.4	15.4	14.0	18.2	21.9
	kW	2.53	2.49	2.41	2.82	2.74	2.68	3.09	3.01	2.88

50KC

50KC*B04 (3 TONS) – UNIT WITH HUMIDI-MIZER SYSTEM IN HOT GAS REHEAT MODE										
TEMP (F) AIR ENT CONDENSER (Edb)		AIR ENTERING EVAPORATOR – Ewb (F)								
		75 Dry Bulb 62.5 Wet Bulb (50% Relative)			75 Dry Bulb 64 Wet Bulb (56% Relative)			75 Dry Bulb 65.3 Wet Bulb (60% Relative)		
		Air Entering Evaporator – Cfm								
		900	1200	1500	900	1200	1500	900	1200	1500
80	TC	12.26	13.13	13.65	13.53	14.48	15.00	14.73	15.63	16.20
	SHC	1.76	3.87	6.09	0.75	2.48	4.33	-0.06	1.30	2.81
	kW	1.92	1.93	1.94	1.96	1.98	2.00	2.00	2.01	2.02
75	TC	14.64	15.64	16.30	15.84	16.73	17.32	16.80	17.38	17.91
	SHC	3.87	6.09	8.38	2.88	4.59	6.29	2.03	3.14	4.39
	kW	1.87	1.88	1.88	1.89	1.90	1.91	1.91	1.92	1.93
70	TC	16.72	17.62	18.01	17.42	18.17	18.62	18.02	18.69	18.87
	SHC	5.89	7.85	9.40	4.65	6.08	7.35	3.71	5.09	5.59
	kW	1.78	1.80	1.82	1.81	1.83	1.84	1.82	1.82	1.86
60	TC	17.43	18.50	18.28	18.09	19.03	19.41	18.32	18.29	19.33
	SHC	7.75	10.06	9.51	7.08	8.34	9.60	6.29	6.94	7.88
	kW	1.66	1.62	1.70	1.67	1.69	1.68	1.69	1.70	1.71
50	TC	17.82	18.59	19.72	18.31	19.73	20.26	18.76	20.21	20.73
	SHC	6.40	7.99	10.05	4.79	6.71	7.97	3.40	5.11	6.16
	kW	1.98	2.03	1.94	2.01	1.94	1.97	2.03	1.96	1.99
40	TC	17.70	19.38	19.85	19.10	20.30	20.34	19.53	20.76	21.26
	SHC	6.30	8.74	10.17	5.54	7.26	8.05	4.13	5.64	6.67
	kW	2.07	1.95	1.99	1.93	1.91	2.02	1.96	1.94	1.97

LEGEND

- Edb – Entering Dry–Bulb
- Ewb – Entering Wet–Bulb
- kW – Compressor Motor Power Input
- ldb – Leaving Dry–Bulb
- lwb – Leaving Wet–Bulb
- SHC – Sensible Heat Capacity (1000 Btuh) Gross
- TC – Total Capacity (1000 Btuh) Gross

NOTES:

1. Direct interpolation is permissible. Do not extrapolate.
2. The following formulas may be used:

$$t_{ldb} = t_{edb} - \frac{\text{sensible capacity (Btuh)}}{1.10 \times \text{cfm}}$$

$$t_{lwb} = \text{Wet-bulb temperature corresponding to enthalpy of air leaving evaporator coil } (h_{lwb})$$

$$h_{lwb} = h_{ewb} - \frac{\text{total capacity (Btuh)}}{4.5 \times \text{cfm}}$$
 Where: h_{ewb} = Enthalpy of air entering evaporator coil

Table 8 – COOLING CAPACITIES

1-STAGE COOLING

4 TONS

50KC

50KC*A05				Ambient Temperature											
				85			95			105			115		
				EA (dB)			EA (dB)			EA (dB)			EA (dB)		
				75	80	85	75	80	85	75	80	85	75	80	85
1200 Cfm	EAT (wb)	58	TC	41.5	41.5	47.0	38.9	38.9	44.0	36.2	36.2	41.0	33.4	33.4	37.8
			SHC	36.1	41.5	47.0	33.8	38.9	44.0	31.4	36.2	41.0	28.9	33.4	37.8
		62	TC	44.9	44.9	44.9	41.4	41.4	42.6	37.8	37.8	40.8	34.0	34.0	38.8
			SHC	32.6	38.5	44.3	30.9	36.8	42.6	29.2	35.0	40.8	27.3	33.1	38.8
		67	TC	49.7	49.7	49.7	46.8	46.8	46.8	43.1	43.1	43.1	39.2	39.2	39.2
			SHC	26.5	32.4	38.2	25.3	31.1	37.0	23.7	29.6	35.5	22.1	27.9	33.8
		72	TC	53.4	53.4	53.4	51.3	51.3	51.3	48.5	48.5	48.5	44.7	44.7	44.7
			SHC	19.8	25.7	31.6	19.0	24.8	30.7	17.8	23.7	29.6	16.4	22.3	28.1
		76	TC	-	55.3	55.3	-	53.3	53.3	-	51.6	51.6	-	48.6	48.6
			SHC	-	20.1	26.7	-	19.4	26.0	-	18.7	25.3	-	17.5	23.8
1400 Cfm	EAT (wb)	58	TC	44.4	44.4	50.2	41.6	41.6	47.0	38.7	38.7	43.8	35.7	35.7	40.5
			SHC	38.6	44.4	50.2	36.1	41.6	47.0	33.6	38.7	43.8	31.0	35.7	40.5
		62	TC	46.6	46.6	48.6	43.1	43.1	46.9	39.4	39.4	44.9	35.8	35.8	42.1
			SHC	35.2	41.9	48.6	33.5	40.2	46.9	31.7	38.3	44.9	29.4	35.8	42.1
		67	TC	51.2	51.2	51.2	48.5	48.5	48.5	44.7	44.7	44.7	40.7	40.7	40.7
			SHC	28.0	34.6	41.2	26.9	33.6	40.3	25.4	32.2	38.9	23.8	30.6	37.3
		72	TC	54.4	54.4	54.4	52.3	52.3	52.3	49.9	49.9	49.9	46.2	46.2	46.2
			SHC	20.2	26.7	33.2	19.4	25.9	32.5	18.5	25.2	31.9	17.1	23.8	30.6
		76	TC	-	55.9	55.9	-	53.9	53.9	-	52.1	52.1	-	49.7	49.7
			SHC	-	20.8	28.5	-	20.0	27.6	-	19.2	26.5	-	18.1	25.3
1600 Cfm	EAT (wb)	58	TC	46.6	46.6	52.7	43.8	43.8	49.6	40.8	40.8	46.2	37.7	37.7	42.7
			SHC	40.5	46.6	52.7	38.1	43.8	49.6	35.4	40.8	46.2	32.7	37.7	42.7
		62	TC	47.9	47.9	52.3	44.6	44.6	50.7	40.9	40.9	48.1	37.8	37.8	44.4
			SHC	37.5	44.9	52.3	35.9	43.3	50.7	33.7	40.9	48.1	31.1	37.8	44.4
		67	TC	51.5	51.5	51.5	48.7	48.7	48.7	44.9	44.9	44.9	40.7	40.7	42.0
			SHC	30.9	38.3	45.7	30.0	37.5	45.0	28.5	36.1	43.7	26.9	34.5	42.0
		72	TC	55.0	55.0	55.0	52.9	52.9	52.9	50.9	50.9	50.9	47.3	47.3	47.3
			SHC	20.4	27.5	34.6	19.6	26.8	33.9	18.9	26.3	33.8	17.6	25.2	32.7
		76	TC	-	56.3	56.3	-	54.3	54.3	-	52.3	52.3	-	50.3	50.3
			SHC	-	21.1	29.4	-	20.2	28.3	-	19.4	27.3	-	18.6	26.5
1800 Cfm	EAT (wb)	58	TC	48.4	48.4	54.7	45.7	45.7	51.7	42.7	42.7	48.3	39.4	39.4	44.6
			SHC	42.1	48.4	54.7	39.7	45.7	51.7	37.0	42.7	48.3	34.2	39.4	44.6
		62	TC	49.1	49.1	55.6	45.9	45.9	53.7	42.7	42.7	50.2	39.5	39.5	46.4
			SHC	39.5	47.6	55.6	37.8	45.8	53.7	35.2	42.7	50.2	32.5	39.5	46.4
		67	TC	53.0	53.0	53.0	50.6	50.6	50.6	47.0	47.0	47.0	42.7	42.7	43.7
			SHC	30.2	38.2	46.1	29.5	37.7	45.8	28.5	36.8	45.2	26.9	35.3	43.7
		72	TC	55.5	55.5	55.5	53.4	53.4	53.4	51.5	51.5	51.5	48.1	48.1	48.1
			SHC	20.6	28.2	35.7	19.8	27.5	35.2	19.2	27.3	35.4	18.1	26.4	34.6
		76	TC	-	56.6	56.6	-	54.6	54.6	-	52.5	52.5	-	50.8	50.8
			SHC	-	21.2	29.9	-	20.4	28.9	-	19.6	28.0	-	18.9	27.4
2000 Cfm	EAT (wb)	58	TC	49.9	49.9	56.4	47.4	47.4	53.6	44.3	44.3	50.1	40.9	40.9	46.3
			SHC	43.4	49.9	56.4	41.2	47.4	53.6	38.4	44.3	50.1	35.5	40.9	46.3
		62	TC	50.1	50.1	58.3	47.5	47.5	55.7	44.3	44.3	52.1	41.0	41.0	48.2
			SHC	41.1	49.7	58.3	39.2	47.5	55.7	36.5	44.3	52.1	33.8	41.0	48.2
		67	TC	53.5	53.5	53.5	51.3	51.3	51.3	47.8	47.8	48.1	43.5	43.5	46.6
			SHC	31.2	39.7	48.3	30.6	39.4	48.1	29.9	39.0	48.1	28.3	37.5	46.6
		72	TC	55.8	55.8	55.8	53.7	53.7	53.7	51.9	51.9	51.9	48.8	48.8	48.8
			SHC	20.7	28.7	36.7	19.9	28.1	36.2	19.4	28.0	36.7	18.5	27.4	36.4
		76	TC	-	56.9	56.9	-	54.8	54.8	-	52.7	52.7	-	51.1	51.1
			SHC	-	21.3	30.4	-	20.5	29.4	-	19.7	28.6	-	19.1	28.2

LEGEND:

- Do not operate
- Cfm - Cubic feet per minute (supply air)
- EAT(db) - Entering air temperature (dry bulb)
- EAT(wb) - Entering air temperature (wet bulb)
- SHC - Sensible heat capacity
- TC - Total capacity

50KC*B05 (4 TONS) – UNIT WITH HUMIDI-MIZER SYSTEM IN SUBCOOLING MODE										
TEMP (F) AIR ENT CONDENSER (Edb)		AIR ENTERING EVAPORATOR – SCFM								
		1200			1600			2000		
		Air Entering Evaporator – Ewb (F)								
		72	67	62	72	67	62	72	67	62
75	TC	35.4	37.1	41.2	40.7	43.2	41.0	44.3	42.2	35.7
	SHC	16.4	21.6	31.5	31.3	24.3	16.9	16.0	22.4	26.9
	kW	3.06	3.07	3.06	3.44	3.43	3.41	3.84	3.82	3.72
85	TC	43.4	36.8	29.6	22.8	30.1	37.9	31.0	23.1	15.6
	SHC	13.0	17.6	21.5	15.5	11.7	7.8	2.0	5.7	9.2
	kW	4.28	4.20	4.05	4.77	4.57	4.42	5.17	4.99	4.81
95	TC	34.5	34.9	35.6	42.8	40.4	37.8	42.4	43.8	39.3
	SHC	16.3	20.9	27.7	36.7	23.8	16.2	16.4	26.1	34.3
	kW	3.25	3.25	3.24	3.63	3.63	3.61	4.04	4.02	4.00
105	TC	44.0	40.3	33.3	26.2	33.7	41.0	34.2	26.1	18.6
	SHC	15.1	22.9	28.9	22.6	17.2	11.1	5.0	10.6	15.8
	kW	4.49	4.47	4.32	4.99	4.87	4.69	5.50	5.28	5.09
115	TC	33.2	33.5	38.3	39.8	37.3	35.4	40.3	42.0	41.3
	SHC	15.6	20.3	31.2	34.7	22.3	15.3	15.9	26.2	39.6
	kW	3.53	3.51	3.46	3.89	3.89	3.88	4.31	4.30	4.26

50KC

50KC*B05 (4 TONS) – UNIT WITH HUMIDI-MIZER SYSTEM IN HOT GAS REHEAT MODE										
TEMP (F) AIR ENT CONDENSER (Edb)		AIR ENTERING EVAPORATOR – Ewb (F)								
		75 Dry Bulb 62.5 Wet Bulb (50% Relative)			75 Dry Bulb 64 Wet Bulb (56% Relative)			75 Dry Bulb 65.3 Wet Bulb (60% Relative)		
		Air Entering Evaporator – Cfm								
		1200	1600	2000	1200	1600	2000	1200	1600	2000
80	TC	15.33	16.26	16.40	17.32	18.21	18.24	18.97	19.72	19.66
	SHC	0.84	3.06	4.94	-0.09	1.62	2.93	-0.90	0.33	1.18
	kW	2.41	2.42	2.42	2.43	2.43	2.43	2.44	2.44	2.44
75	TC	19.17	20.36	20.57	20.97	21.94	21.95	22.30	23.03	22.88
	SHC	4.46	6.89	8.60	3.50	5.31	6.45	2.61	3.93	4.64
	kW	2.76	2.75	2.75	2.76	2.75	2.74	2.76	2.76	2.75
70	TC	22.63	23.67	23.55	23.97	24.55	24.19	24.87	25.09	24.52
	SHC	7.91	10.13	11.21	6.83	8.40	9.04	5.88	7.04	7.39
	kW	2.80	2.78	2.77	2.80	2.77	2.76	2.81	2.80	2.78
60	TC	27.32	28.34	21.46	27.68	16.17	25.05	28.38	18.51	20.56
	SHC	13.66	15.45	13.04	11.75	4.46	12.58	11.21	10.82	10.87
	kW	2.85	2.86	2.86	2.89	2.80	2.91	2.88	2.84	2.88
50	TC	11.00	11.31	12.76	14.48	13.83	13.72	15.32	15.18	17.14
	SHC	7.10	9.20	11.20	5.13	6.46	9.10	4.21	4.49	6.19
	kW	2.95	2.94	2.93	2.94	2.92	2.92	2.94	2.93	2.92
40	TC	9.73	9.83	9.75	12.40	12.60	12.20	15.23	15.45	15.13
	SHC	8.46	9.50	9.20	7.57	8.47	9.50	7.64	8.14	8.80
	kW	3.04	3.04	3.03	3.03	3.01	3.01	3.03	3.02	3.02

LEGEND

- Edb – Entering Dry–Bulb
- Ewb – Entering Wet–Bulb
- kW – Compressor Motor Power Input
- ldb – Leaving Dry–Bulb
- lwb – Leaving Wet–Bulb
- SHC – Sensible Heat Capacity (1000 Btuh) Gross
- TC – Total Capacity (1000 Btuh) Gross

NOTES:

1. Direct interpolation is permissible. Do not extrapolate.
2. The following formulas may be used:

$$t_{ldb} = t_{edb} - \frac{\text{sensible capacity (Btuh)}}{1.10 \times \text{cfm}}$$

$$t_{lwb} = \text{Wet-bulb temperature corresponding to enthalpy of air leaving evaporator coil } (h_{lwb})$$

$$h_{lwb} = h_{ewb} - \frac{\text{total capacity (Btuh)}}{4.5 \times \text{cfm}}$$
 Where: h_{ewb} = Enthalpy of air entering evaporator coil

Table 10 – COOLING CAPACITIES

1-STAGE COOLING

5 TONS

50KC

50KC*A06				Ambient Temperature											
				85			95			105			115		
				EA (dB)			EA (dB)			EA (dB)			EA (dB)		
				75	80	85	75	80	85	75	80	85	75	80	85
1500 Cfm	EAT (wb)	58	TC	53.0	53.0	60.2	50.0	50.0	56.8	46.9	46.9	53.4	44.4	44.4	50.4
			SHC	45.9	53.0	60.2	43.1	50.0	56.8	40.3	46.9	53.4	38.4	44.4	50.4
		62	TC	56.0	56.0	57.5	52.2	52.2	55.4	48.2	48.2	53.3	44.7	44.7	52.1
			SHC	41.4	49.5	57.5	39.3	47.4	55.4	37.2	45.2	53.3	36.2	44.2	52.1
		67	TC	62.4	62.4	62.4	58.8	58.8	58.8	54.8	54.8	54.8	51.0	51.0	51.0
			SHC	33.5	41.4	49.4	31.7	39.7	47.7	29.6	37.7	45.7	28.6	36.6	44.6
		72	TC	67.5	67.5	67.5	64.3	64.3	64.3	60.7	60.7	60.7	55.4	55.4	55.4
			SHC	25.0	32.4	39.8	23.3	31.0	38.6	21.5	29.3	37.0	19.8	27.2	34.7
		76	TC	-	71.1	71.1	-	68.3	68.3	-	64.8	64.8	-	58.4	58.4
			SHC	-	25.6	32.7	-	24.2	31.3	-	22.5	29.9	-	20.3	27.7
1750 Cfm	EAT (wb)	58	TC	56.7	56.7	64.3	53.5	53.5	60.8	50.2	50.2	57.2	47.4	47.4	53.9
			SHC	49.1	56.7	64.3	46.2	53.5	60.8	43.3	50.2	57.2	41.0	47.4	53.9
		62	TC	58.3	58.3	63.9	54.4	54.4	61.8	51.8	51.8	56.4	47.5	47.5	56.1
			SHC	45.3	54.6	63.9	43.2	52.5	61.8	39.6	48.0	56.4	38.9	47.5	56.1
		67	TC	64.0	64.0	64.0	60.6	60.6	60.6	56.6	56.6	56.6	52.3	52.3	52.3
			SHC	35.5	44.5	53.6	33.9	43.1	52.4	32.0	41.3	50.6	30.6	39.7	48.8
		72	TC	68.9	68.9	68.9	65.9	65.9	65.9	62.2	62.2	62.2	56.6	56.6	56.6
			SHC	25.5	33.9	42.2	24.0	32.7	41.4	22.2	31.1	40.1	20.2	28.7	37.1
		76	TC	-	72.4	72.4	-	69.7	69.7	-	66.1	66.1	-	59.5	59.5
			SHC	-	26.4	34.9	-	24.9	33.2	-	23.2	31.7	-	21.0	29.5
2000 Cfm	EAT (wb)	58	TC	59.8	59.8	67.8	56.5	56.5	64.2	53.1	53.1	60.4	50.0	50.0	56.8
			SHC	51.8	59.8	67.8	48.9	56.5	64.2	45.8	53.1	60.4	43.3	50.0	56.8
		62	TC	60.2	60.2	69.7	57.0	57.0	66.0	53.2	53.2	62.9	50.1	50.1	59.2
			SHC	48.8	59.3	69.7	46.1	56.0	66.0	43.4	53.2	62.9	41.1	50.1	59.2
		67	TC	65.3	65.3	65.3	61.8	61.8	61.8	56.7	56.7	57.6	52.4	52.4	55.7
			SHC	37.3	47.4	57.4	35.9	46.2	56.6	36.4	47.0	57.6	34.9	45.3	55.7
		72	TC	70.2	70.2	70.2	67.0	67.0	67.0	63.2	63.2	63.2	57.3	57.3	57.3
			SHC	26.1	35.4	44.8	24.5	34.1	43.7	22.8	32.7	42.6	20.6	30.1	39.5
		76	TC	-	73.4	73.4	-	70.6	70.6	-	67.1	67.1	-	60.3	60.3
			SHC	-	27.0	36.5	-	25.5	35.0	-	23.8	33.3	-	21.5	31.0
2250 Cfm	EAT (wb)	58	TC	62.2	62.2	70.5	59.0	59.0	66.9	55.5	55.5	63.0	52.1	52.1	59.1
			SHC	54.0	62.2	70.5	51.1	59.0	66.9	47.9	55.5	63.0	45.0	52.1	59.1
		62	TC	63.4	63.4	70.9	59.1	59.1	69.7	55.5	55.5	65.6	52.1	52.1	61.5
			SHC	50.2	60.5	70.9	48.5	59.1	69.7	45.4	55.5	65.6	42.7	52.1	61.5
		67	TC	66.3	66.3	66.3	62.4	62.4	62.4	58.9	58.9	59.6	54.1	54.1	56.3
			SHC	38.9	50.0	61.0	39.2	50.8	62.3	36.2	47.9	59.6	34.0	45.2	56.3
		72	TC	71.1	71.1	71.1	68.0	68.0	68.0	64.1	64.1	64.1	57.9	57.9	57.9
			SHC	26.5	36.8	47.1	25.0	35.5	46.1	23.3	34.1	45.0	21.0	31.3	41.7
		76	TC	-	74.0	74.0	-	71.4	71.4	-	67.8	67.8	-	61.0	61.0
			SHC	-	27.3	37.6	-	26.0	36.5	-	24.3	34.9	-	21.8	32.2
2500 Cfm	EAT (wb)	58	TC	64.0	64.0	72.4	60.9	60.9	69.1	57.4	57.4	65.2	53.3	53.3	60.5
			SHC	55.5	64.0	72.4	52.8	60.9	69.1	49.6	57.4	65.2	46.1	53.3	60.5
		62	TC	64.0	64.0	75.3	61.0	61.0	71.9	57.4	57.4	67.9	53.4	53.4	63.0
			SHC	52.7	64.0	75.3	50.1	61.0	71.9	47.0	57.4	67.9	43.8	53.4	63.0
		67	TC	67.3	67.3	67.3	63.7	63.7	64.5	59.5	59.5	64.2	54.6	54.6	59.3
			SHC	40.6	52.5	64.5	39.6	52.0	64.5	38.7	51.5	64.2	35.4	47.3	59.3
		72	TC	71.7	71.7	71.7	68.8	68.8	68.8	64.9	64.9	64.9	58.4	58.4	58.4
			SHC	26.7	37.9	49.1	25.4	37.0	48.5	23.7	35.5	47.3	21.2	32.4	43.6
		76	TC	-	74.5	74.5	-	72.1	72.1	-	68.4	68.4	-	61.6	61.6
			SHC	-	27.4	38.5	-	26.3	37.7	-	24.7	36.3	-	22.1	33.3

LEGEND:

- Do not operate
- Cfm - Cubic feet per minute (supply air)
- EAT(db) - Entering air temperature (dry bulb)
- EAT(wb) - Entering air temperature (wet bulb)
- SHC - Sensible heat capacity
- TC - Total capacity

50KC*B06 (5 TONS) – UNIT WITH HUMIDI-MIZER SYSTEM IN SUBCOOLING MODE										
TEMP (F) AIR ENT CONDENSER (Edb)		AIR ENTERING EVAPORATOR – SCFM								
		1750			2000			2250		
		Air Entering Evaporator – Ewb (F)								
		72	67	62	72	67	62	72	67	62
75	TC	51.1	56.4	57.9	47.8	49.9	57.3	49.6	48.9	53.8
	SHC	25.5	36.1	50.4	24.6	31.3	50.3	25.8	32.0	44.8
	kW	3.20	3.30	3.19	3.25	3.18	3.13	3.22	3.13	3.25
85	TC	54.1	60.4	61.0	56.4	60.4	60.5	56.7	60.7	58.2
	SHC	47.2	38.7	28.0	52.3	40.6	28.8	27.2	42.6	56.5
	kW	3.59	3.67	3.79	3.81	3.70	3.60	3.70	3.74	3.61
95	TC	62.4	56.6	48.4	62.7	58.6	50.5	62.8	60.0	52.6
	SHC	26.3	34.9	41.9	27.8	38.7	46.9	29.0	42.1	51.5
	kW	4.20	4.09	3.92	3.97	4.10	4.25	4.28	4.12	4.03
105	TC	58.8	49.9	41.6	60.5	51.9	43.6	61.6	53.5	47.6
	SHC	22.0	29.0	35.8	24.4	32.9	40.7	26.5	36.6	42.3
	kW	4.64	4.46	4.28	4.33	4.52	4.66	4.69	4.57	4.41
115	TC	51.4	41.9	33.8	53.3	43.7	35.9	54.7	45.3	39.2
	SHC	15.7	22.2	29.0	18.1	26.0	33.9	20.4	29.7	35.3
	kW	5.08	4.83	4.63	4.69	4.88	5.14	5.19	4.92	4.77

50KC

50KC*B06 (5 TONS) – UNIT WITH HUMIDI-MIZER SYSTEM IN HOT GAS REHEAT MODE										
TEMP (F) AIR ENT CONDENSER (Edb)		AIR ENTERING EVAPORATOR – Ewb (F)								
		75 Dry Bulb 62.5 Wet Bulb (50% Relative)			75 Dry Bulb 64 Wet Bulb (56% Relative)			75 Dry Bulb 65.3 Wet Bulb (60% Relative)		
		Air Entering Evaporator – Cfm								
		1750	2000	2250	1750	2000	2250	1750	2000	2250
80	TC	13.19	12.95	12.70	14.56	14.30	14.00	15.70	15.44	15.05
	SHC	-2.38	-1.55	-0.65	-4.75	-4.25	-3.69	-6.74	-6.49	-6.21
	kW	3.15	3.16	3.16	3.19	3.20	3.20	3.22	3.23	3.23
75	TC	16.14	15.95	15.71	17.36	17.20	16.84	18.30	18.20	17.81
	SHC	0.44	1.23	2.03	-1.92	-1.36	-0.96	-3.90	-3.50	-3.31
	kW	3.04	3.05	3.06	3.07	3.08	3.09	3.10	3.12	3.12
70	TC	18.90	18.68	18.52	19.97	19.85	19.50	20.86	20.62	20.17
	SHC	3.13	3.80	4.51	0.85	1.39	1.70	-0.97	-0.69	-0.63
	kW	2.92	2.93	2.95	2.96	2.97	2.98	2.98	2.99	3.00
60	TC	23.71	23.48	23.16	24.05	23.98	23.52	24.79	24.47	26.99
	SHC	8.11	8.63	8.88	5.97	6.46	6.58	4.65	4.87	5.94
	kW	3.17	3.23	3.15	3.21	3.26	3.18	3.23	3.12	3.10
50	TC	21.91	16.69	16.62	16.81	16.98	16.92	17.08	17.24	17.17
	SHC	11.51	10.04	9.64	9.77	9.43	8.95	9.30	8.88	8.35
	kW	3.01	3.07	3.11	3.04	3.10	3.15	3.07	3.14	3.18
40	TC	21.91	16.69	16.62	16.81	16.98	16.92	17.08	17.24	17.17
	SHC	11.51	10.04	9.64	9.77	9.43	8.95	9.30	8.88	8.35
	kW	3.39	3.32	3.24	3.14	3.23	3.15	3.18	3.27	3.08

LEGEND

- Edb – Entering Dry–Bulb
- Ewb – Entering Wet–Bulb
- kW – Compressor Motor Power Input
- ldb – Leaving Dry–Bulb
- lwb – Leaving Wet–Bulb
- SHC – Sensible Heat Capacity (1000 Btuh) Gross
- TC – Total Capacity (1000 Btuh) Gross

Table 12 – STATIC PRESSURE ADDERS (IN. WG) (FACTORY OPTIONS AND/OR ACCESSORIES)

3-5 TONS										
CFM	600	900	1200	1400	1600	1800	2000	2200	2400	2600
1 Electric Heater Module	0.03	0.05	0.07	0.09	0.09	0.10	0.11	0.11	0.12	0.13
2 Electric Heater Modules	0.13	0.15	0.16	0.16	0.16	0.17	0.17	0.17	0.18	0.18

3-5-TONS										
CFM	600	800	1000	1250	1500	1750	2000	2250	2500	
Vertical Economizer	0.012	0.020	0.030	0.046	0.066	0.089	0.115	0.145	0.179	
Horizontal Economizer	0.018	0.026	0.037	0.053	0.073	0.096	0.124	0.154	0.189	

All above data for both standard and ultra low leak models, where available.

3-5-TONS										
CFM	600	800	1000	1250	1500	1750	2000	2250	2500	
Humidi-MiZer	0.023	0.033	0.042	0.054	0.067	0.080	0.093	0.106	0.120	

3-5-TONS						
Power Exhaust Performance						
Return Duct Static Pressure (in wg)	0.0	0.1	0.2	0.3	0.4	0.5
Vertical Power Exhaust CFM	3239	2974	2642	2244	1780	1249

50KC

GENERAL FAN PERFORMANCE NOTES

1. Interpolation is permissible. Do not extrapolate.
2. External static pressure is the static pressure difference between the return duct and the supply duct plus the static pressure caused by any FIOPs or accessories.
3. Tabular data accounts for pressure loss due to clean filters, unit casing, and wet coils. Factory options and accessories may add static pressure losses. Selection software is available, through your salesperson, to help you select the best motor/drive combination for your application.
4. The Fan Performance tables offer motor/drive recommendations. In cases when two motor/drive combinations would work, Carrier recommended the lower horsepower option.
5. For information on the electrical properties of Carrier motors, please see the Electrical information section of this book.
6. For more information on the performance limits of Carrier motors, see the application data section of this book.
7. The EPACT (Energy Policy Act of 1992) regulates energy requirements for specific types of indoor fan motors. Motors regulated by EPACT include any general purpose, T-frame (three-digit, 143 and larger), single-speed, foot mounted, polyphase, squirrel cage induction motors of NEMA (National Electrical Manufacturers Association) design A and B, manufactured for use in the United States. Ranging from 1 to 200 Hp, these continuous-duty motors operate on 230 and 460 volt, 60 Hz power. If a motor does not fit into these specifications, the motor does not have to be replaced by an EPACT compliant energy-efficient motor. Variable-speed motors are exempt from EPACT compliance requirements. Therefore, the indoor fan motors for Carrier 50KC-*04/06 units are exempt from these requirements.

FAN PERFORMANCE (DIRECT DRIVE)

Table 13 – 50KC-04 Vertical Unit - Direct Drive

Speed (Torque) tap	CFM	ESP	BHP
1	900	0.36	0.16
	975	0.27	0.16
	1050	0.19	0.15
	1125	0.11	0.15
	1200	0.04	0.16
	1275	–	–
	1350	–	–
	1425	–	–
	1500	–	–
2	900	0.53	0.22
	975	0.43	0.21
	1050	0.32	0.21
	1125	0.22	0.20
	1200	0.13	0.19
	1275	0.04	0.18
	1350	–	–
	1425	–	–
	1500	–	–
3	900	0.81	0.32
	975	0.70	0.31
	1050	0.60	0.30
	1125	0.49	0.29
	1200	0.38	0.27
	1275	0.27	0.26
	1350	0.18	0.25
	1425	0.10	0.24
	1500	–	–
4	900	1.06	0.42
	975	0.95	0.42
	1050	0.84	0.42
	1125	0.73	0.41
	1200	0.60	0.39
	1275	0.48	0.38
	1350	0.35	0.36
	1425	0.22	0.34
	1500	0.11	0.31
5	900	1.24	0.51
	975	1.19	0.52
	1050	1.14	0.54
	1125	1.08	0.57
	1200	1.03	0.59
	1275	0.98	0.61
	1350	0.93	0.64
	1425	0.88	0.67
	1500	0.82	0.69

Table 14 – 50KC-04 Horizontal Unit - Direct Drive

Speed (Torque) tap	CFM	ESP	BHP
1	900	0.47	0.21
	975	0.38	0.20
	1050	0.29	0.19
	1125	0.21	0.18
	1200	0.13	0.18
	1275	0.06	0.20
	1350	–	–
	1425	–	–
	1500	–	–
2	900	0.65	0.27
	975	0.54	0.26
	1050	0.44	0.25
	1125	0.33	0.24
	1200	0.23	0.23
	1275	0.13	0.21
	1350	0.02	0.20
	1425	–	–
	1500	–	–
3	900	0.96	0.38
	975	0.84	0.37
	1050	0.73	0.36
	1125	0.61	0.34
	1200	0.50	0.33
	1275	0.38	0.31
	1350	0.26	0.30
	1425	0.15	0.28
	1500	0.04	0.26
4	900	1.17	0.46
	975	1.08	0.46
	1050	0.98	0.46
	1125	0.87	0.45
	1200	0.75	0.44
	1275	0.63	0.42
	1350	0.51	0.40
	1425	0.39	0.39
	1500	0.27	0.37
5	900	1.35	0.52
	975	1.30	0.54
	1050	1.26	0.57
	1125	1.21	0.59
	1200	1.16	0.62
	1275	1.12	0.64
	1350	1.07	0.67
	1425	1.02	0.70
	1500	0.97	0.73

50KC

FAN PERFORMANCE (DIRECT DRIVE) (cont.)

Table 15 – 50KC-05 Vertical Unit - Direct Drive

Speed (Torque) tap	CFM	ESP	BHP
1	1200	0.50	0.32
	1300	0.35	0.31
	1400	0.20	0.29
	1500	–	–
	1600	–	–
	1700	–	–
	1800	–	–
	1900	–	–
	2000	–	–
2	1200	0.63	0.38
	1300	0.46	0.36
	1400	0.30	0.34
	1500	0.15	0.32
	1600	–	–
	1700	–	–
	1800	–	–
	1900	–	–
	2000	–	–
3	1200	0.98	0.56
	1300	0.88	0.59
	1400	0.75	0.59
	1500	0.61	0.56
	1600	0.44	0.53
	1700	0.26	0.53
	1800	0.08	0.48
	1900	–	–
	2000	–	–
4	1200	1.00	0.57
	1300	0.94	0.60
	1400	0.87	0.63
	1500	0.78	0.66
	1600	0.68	0.69
	1700	0.57	0.71
	1800	0.43	0.68
	1900	0.28	0.67
	2000	–	–
5	1200	1.03	0.59
	1300	0.96	0.62
	1400	0.89	0.66
	1500	0.82	0.69
	1600	0.75	0.73
	1700	0.67	0.77
	1800	0.58	0.81
	1900	0.50	0.85
	2000	0.40	0.89

Table 16 – 50KC-05 Horizontal Unit - Direct Drive

Speed (Torque) tap	CFM	ESP	BHP
1	1200	0.61	0.38
	1300	0.45	0.36
	1400	0.30	0.33
	1500	0.15	0.31
	1600	0.03	0.29
	1700	–	–
	1800	–	–
	1900	–	–
	2000	–	–
2	1200	0.75	0.44
	1300	0.59	0.42
	1400	0.43	0.39
	1500	0.27	0.37
	1600	0.12	0.35
	1700	0.01	0.32
	1800	–	–
	1900	–	–
	2000	–	–
3	1200	1.13	0.59
	1300	1.03	0.62
	1400	0.91	0.63
	1500	0.76	0.61
	1600	0.61	0.59
	1700	0.43	0.59
	1800	0.26	0.54
	1900	0.09	0.51
	2000	–	–
4	1200	1.15	0.60
	1300	1.08	0.64
	1400	1.01	0.67
	1500	0.93	0.70
	1600	0.84	0.73
	1700	0.74	0.75
	1800	0.62	0.75
	1900	0.47	0.73
	2000	0.31	0.71
5	1200	1.16	0.62
	1300	1.10	0.65
	1400	1.04	0.69
	1500	0.97	0.73
	1600	0.90	0.77
	1700	0.84	0.81
	1800	0.76	0.85
	1900	0.69	0.89
	2000	0.61	0.93

50KC

FAN PERFORMANCE (DIRECT DRIVE) (cont.)

Table 17 – 50KC-06 Vertical Unit - Direct Drive

Speed (Torque) tap	CFM	ESP	BHP
1	1500	0.46	0.42
	1625	0.29	0.39
	1750	0.11	0.37
	1875	–	–
	2000	–	–
	2125	–	–
	2250	–	–
	2375	–	–
	2500	–	–
2	1500	0.68	0.54
	1625	0.48	0.51
	1750	0.30	0.48
	1875	0.13	0.45
	2000	–	–
	2125	–	–
	2250	–	–
	2375	–	–
	2500	–	–
3	1500	1.17	0.82
	1625	0.98	0.80
	1750	0.78	0.79
	1875	0.56	0.76
	2000	0.36	0.72
	2125	0.17	0.72
	2250	0.02	0.64
	2375	–	–
	2500	–	–
4	1500	1.29	0.91
	1625	1.14	0.89
	1750	0.96	0.92
	1875	0.75	0.90
	2000	0.53	0.86
	2125	0.32	0.82
	2250	0.12	0.78
	2375	0.01	0.75
	2500	–	–
5	1500	1.36	0.94
	1625	1.24	0.99
	1750	1.10	1.02
	1875	0.93	1.05
	2000	0.74	1.03
	2125	0.53	0.99
	2250	0.31	0.94
	2375	0.08	0.90
	2500	–	0.86

Table 18 – 50KC-06 Horizontal Unit - Direct Drive

Speed (Torque) tap	CFM	ESP	BHP
1	1500	0.59	0.46
	1625	0.41	0.44
	1750	0.23	0.40
	1875	0.07	0.37
	2000	–	–
	2125	–	–
	2250	–	–
	2375	–	–
	2500	–	–
2	1500	0.83	0.58
	1625	0.63	0.55
	1750	0.44	0.52
	1875	0.26	0.49
	2000	0.08	0.45
	2125	–	–
	2250	–	–
	2375	–	–
	2500	–	–
3	1500	1.34	0.87
	1625	1.17	0.85
	1750	0.97	0.83
	1875	0.76	0.80
	2000	0.55	0.76
	2125	0.34	0.76
	2250	0.17	0.68
	2375	0.04	0.63
	2500	–	–
4	1500	1.47	0.94
	1625	1.33	0.93
	1750	1.17	0.97
	1875	0.98	0.96
	2000	0.77	0.92
	2125	0.56	0.88
	2250	0.35	0.84
	2375	0.16	0.79
	2500	0.01	0.73
5	1500	1.52	0.97
	1625	1.42	1.01
	1750	1.30	1.05
	1875	1.16	1.09
	2000	1.00	1.09
	2125	0.82	1.06
	2250	0.62	1.02
	2375	0.40	0.98
	2500	0.16	0.93

50KC

FAN PERFORMANCE (BELT DRIVE) (cont.)

Table 19 – 50KC-*04

1 PHASE

3 TON VERTICAL SUPPLY

CFM	AVAILABLE EXTERNAL STATIC PRESSURE (in. wg)									
	0.2		0.4		0.6		0.8		1.0	
	RPM	BHP	RPM	BHP	RPM	BHP	RPM	BHP	RPM	BHP
900	594	0.15	740	0.25	867	0.37	981	0.52	1084	0.68
975	618	0.17	758	0.28	881	0.40	991	0.55	1092	0.71
1050	642	0.19	777	0.30	896	0.43	1003	0.58	1102	0.75
1125	668	0.22	797	0.34	912	0.47	1017	0.62	1113	0.79
1200	695	0.25	818	0.37	930	0.51	1032	0.66	1126	0.83
1275	722	0.29	841	0.41	949	0.55	1048	0.71	1140	0.88
1350	750	0.33	864	0.46	968	0.60	1065	0.76	1155	0.93
1425	778	0.37	888	0.50	989	0.65	1083	0.81	1171	0.99
1500	807	0.42	913	0.56	1011	0.71	1103	0.87	1188	1.05

CFM	AVAILABLE EXTERNAL STATIC PRESSURE (in. wg)									
	1.2		1.4		1.6		1.8		2.0	
	RPM	BHP	RPM	BHP	RPM	BHP	RPM	BHP	RPM	BHP
900	1180	0.86	1269	1.05	1354	1.25	1434	1.47	-	-
975	1186	0.89	1275	1.08	1358	1.29	-	-	-	-
1050	1194	0.92	1281	1.12	1363	1.32	-	-	-	-
1125	1204	0.97	1289	1.16	1370	1.37	-	-	-	-
1200	1215	1.01	1298	1.21	1378	1.42	-	-	-	-
1275	1227	1.06	1309	1.26	1387	1.47	-	-	-	-
1350	1240	1.12	1321	1.32	-	-	-	-	-	-
1425	1254	1.18	1333	1.38	-	-	-	-	-	-
1500	1270	1.24	1347	1.45	-	-	-	-	-	-

NOTE: For more information, see General Fan Performance Notes.

Boldface indicates field-supplied drive is required.

Medium static 770–1175 RPM, 1.2 BHP max

High static 1035–1466 RPM, 1.5 BHP max

50KC

Table 20 – 50KC-*04

1 PHASE

3 TON HORIZONTAL SUPPLY

CFM	AVAILABLE EXTERNAL STATIC PRESSURE (in. wg)									
	0.2		0.4		0.6		0.8		1.0	
	RPM	BHP	RPM	BHP	RPM	BHP	RPM	BHP	RPM	BHP
900	574	0.13	707	0.23	817	0.34	913	0.47	999	0.61
975	597	0.15	727	0.25	835	0.37	929	0.50	1015	0.64
1050	621	0.18	747	0.28	853	0.40	946	0.53	1030	0.68
1125	646	0.20	768	0.31	872	0.43	964	0.57	1047	0.72
1200	671	0.23	790	0.34	892	0.47	982	0.61	1064	0.76
1275	696	0.26	812	0.38	912	0.51	1001	0.65	1082	0.81
1350	723	0.30	835	0.42	933	0.55	1020	0.70	1100	0.86
1425	749	0.34	859	0.46	955	0.60	1040	0.75	1119	0.91
1500	776	0.38	883	0.51	977	0.65	1061	0.80	1138	0.97

CFM	AVAILABLE EXTERNAL STATIC PRESSURE (in. wg)									
	1.2		1.4		1.6		1.8		2.0	
	RPM	BHP	RPM	BHP	RPM	BHP	RPM	BHP	RPM	BHP
900	1078	0.77	1151	0.93	1220	1.11	1284	1.30	1346	1.49
975	1093	0.80	1165	0.97	1233	1.15	1297	1.33	-	-
1050	1108	0.84	1180	1.01	1247	1.19	1311	1.38	-	-
1125	1123	0.88	1195	1.05	1261	1.23	1325	1.42	-	-
1200	1140	0.92	1210	1.10	1276	1.28	1339	1.47	-	-
1275	1157	0.97	1226	1.15	1292	1.33	-	-	-	-
1350	1174	1.02	1243	1.20	1308	1.39	-	-	-	-
1425	1192	1.08	1260	1.26	1325	1.45	-	-	-	-
1500	1210	1.14	1278	1.33	-	-	-	-	-	-

NOTE: For more information, see General Fan Performance Notes.

Boldface indicates field-supplied drive is required.

Medium static 770–1175 RPM, 1.2 BHP max

High static 1035–1466 RPM, 1.5 BHP max

FAN PERFORMANCE (BELT DRIVE) (cont.)

Table 21 – 50KC-*04

3 PHASE

3 TON VERTICAL SUPPLY

CFM	AVAILABLE EXTERNAL STATIC PRESSURE (in. wg)									
	0.2		0.4		0.6		0.8		1.0	
	RPM	BHP	RPM	BHP	RPM	BHP	RPM	BHP	RPM	BHP
900	594	0.15	740	0.25	867	0.37	981	0.52	1084	0.68
975	618	0.17	758	0.28	881	0.40	991	0.55	1092	0.71
1050	642	0.19	777	0.30	896	0.43	1003	0.58	1102	0.75
1125	668	0.22	797	0.34	912	0.47	1017	0.62	1113	0.79
1200	695	0.25	818	0.37	930	0.51	1032	0.66	1126	0.83
1275	722	0.29	841	0.41	949	0.55	1048	0.71	1140	0.88
1350	750	0.33	864	0.46	968	0.60	1065	0.76	1155	0.93
1425	778	0.37	888	0.50	989	0.65	1083	0.81	1171	0.99
1500	807	0.42	913	0.56	1011	0.71	1103	0.87	1188	1.05

50KC

CFM	Available External Static Pressure (in. wg)									
	1.2		1.4		1.6		1.8		2.0	
	RPM	BHP	RPM	BHP	RPM	BHP	RPM	BHP	RPM	BHP
900	1180	0.86	1269	1.05	1354	1.25	1434	1.47	1511	1.70
975	1186	0.89	1275	1.08	1358	1.29	1437	1.51	1513	1.74
1050	1194	0.92	1281	1.12	1363	1.32	1441	1.54	1516	1.78
1125	1204	0.97	1289	1.16	1370	1.37	1447	1.59	1520	1.82
1200	1215	1.01	1298	1.21	1378	1.42	1454	1.64	1526	1.87
1275	1227	1.06	1309	1.26	1387	1.47	1462	1.69	1533	1.92
1350	1240	1.12	1321	1.32	1397	1.53	1471	1.75	1541	1.99
1425	1254	1.18	1333	1.38	1409	1.59	1481	1.82	–	–
1500	1270	1.24	1347	1.45	1421	1.66	1492	1.89	–	–

NOTE: For more information, see General Fan Performance Notes.

Boldface indicates field – supplied drive is required.

Medium static 770 – 1175 RPM, 1.7 BHP max
 High static 1035 – 1466 RPM, 2.9 BHP max

Table 22 – 50KC-*04

3 PHASE

3 TON HORIZONTAL SUPPLY

CFM	AVAILABLE EXTERNAL STATIC PRESSURE (in. wg)									
	0.2		0.4		0.6		0.8		1.0	
	RPM	BHP	RPM	BHP	RPM	BHP	RPM	BHP	RPM	BHP
900	574	0.13	707	0.23	817	0.34	913	0.47	999	0.61
975	597	0.15	727	0.25	835	0.37	929	0.50	1015	0.64
1050	621	0.18	747	0.28	853	0.40	946	0.53	1030	0.68
1125	646	0.20	768	0.31	872	0.43	964	0.57	1047	0.72
1200	671	0.23	790	0.34	892	0.47	982	0.61	1064	0.76
1275	696	0.26	812	0.38	912	0.51	1001	0.65	1082	0.81
1350	723	0.30	835	0.42	933	0.55	1020	0.70	1100	0.86
1425	749	0.34	859	0.46	955	0.60	1040	0.75	1119	0.91
1500	776	0.38	883	0.51	977	0.65	1061	0.80	1138	0.97

CFM	AVAILABLE EXTERNAL STATIC PRESSURE (in. wg)									
	1.2		1.4		1.6		1.8		2.0	
	RPM	BHP	RPM	BHP	RPM	BHP	RPM	BHP	RPM	BHP
900	1078	0.77	1151	0.93	1220	1.11	1284	1.30	1346	1.49
975	1093	0.80	1165	0.97	1233	1.15	1297	1.33	1358	1.53
1050	1108	0.84	1180	1.01	1247	1.19	1311	1.38	1371	1.58
1125	1123	0.88	1195	1.05	1261	1.23	1325	1.42	1385	1.62
1200	1140	0.92	1210	1.10	1276	1.28	1339	1.47	1399	1.68
1275	1157	0.97	1226	1.15	1292	1.33	1354	1.53	1414	1.73
1350	1174	1.02	1243	1.20	1308	1.39	1370	1.59	1429	1.80
1425	1192	1.08	1260	1.26	1325	1.45	1386	1.65	1444	1.86
1500	1210	1.14	1278	1.33	1342	1.52	1403	1.72	1461	1.93

NOTE: For more information, see General Fan Performance Notes.

Boldface indicates field – supplied drive is required.

Medium static 770 – 1175 RPM, 1.7 BHP max v
 High static 1035 – 1466 RPM, 2.9 BHP max

FAN PERFORMANCE (BELT DRIVE) (cont.)

Table 23 – 50KC-#05

1 PHASE

4 TON VERTICAL SUPPLY

CFM	AVAILABLE EXTERNAL STATIC PRESSURE (in. wg)									
	0.2		0.4		0.6		0.8		1.0	
	RPM	BHP	RPM	BHP	RPM	BHP	RPM	BHP	RPM	BHP
1200	695	0.25	818	0.37	930	0.51	1032	0.66	1126	0.83
1300	731	0.30	849	0.43	955	0.57	1053	0.72	1145	0.89
1400	769	0.36	880	0.49	982	0.63	1077	0.79	1166	0.97
1500	807	0.42	913	0.56	1011	0.71	1103	0.87	1188	1.05
1600	847	0.49	948	0.63	1042	0.79	1130	0.96	1213	1.14
1700	887	0.57	983	0.72	1073	0.88	1158	1.06	1239	1.24
1800	928	0.66	1020	0.82	1106	0.98	1188	1.16	1266	1.35
1900	969	0.76	1057	0.92	1140	1.09	1219	1.28	1295	1.48
2000	1010	0.87	1095	1.04	1175	1.21	1251	1.41	-	-

CFM	AVAILABLE EXTERNAL STATIC PRESSURE (in. wg)									
	1.2		1.4		1.6		1.8		2.0	
	RPM	BHP	RPM	BHP	RPM	BHP	RPM	BHP	RPM	BHP
1200	1215	1.01	1298	1.21	1378	1.42	-	-	-	-
1300	1231	1.08	1313	1.28	1390	1.49	-	-	-	-
1400	1249	1.16	1329	1.36	-	-	-	-	-	-
1500	1270	1.24	1347	1.45	-	-	-	-	-	-
1600	1292	1.34	-	-	-	-	-	-	-	-
1700	1315	1.44	-	-	-	-	-	-	-	-
1800	-	-	-	-	-	-	-	-	-	-
1900	-	-	-	-	-	-	-	-	-	-
2000	-	-	-	-	-	-	-	-	-	-

NOTE: For more information, see General Fan Performance Notes.

Boldface indicates field-supplied drive is required.

Medium static 770–1175 RPM, 1.2 BHP max

High static 1035–1466 RPM, 1.5 BHP max

50KC

Table 24 – 50KC-#05

1 PHASE

4 TON HORIZONTAL SUPPLY

CFM	AVAILABLE EXTERNAL STATIC PRESSURE (in. wg)									
	0.2		0.4		0.6		0.8		1.0	
	RPM	BHP	RPM	BHP	RPM	BHP	RPM	BHP	RPM	BHP
1200	671	0.23	790	0.34	892	0.47	982	0.61	1064	0.76
1300	705	0.28	820	0.39	919	0.52	1007	0.67	1088	0.82
1400	740	0.33	851	0.45	947	0.58	1034	0.73	1113	0.89
1500	776	0.38	883	0.51	977	0.65	1061	0.80	1138	0.97
1600	813	0.45	916	0.58	1007	0.73	1089	0.89	1165	1.05
1700	851	0.52	949	0.66	1038	0.81	1118	0.97	1192	1.15
1800	888	0.60	984	0.75	1069	0.90	1148	1.07	1221	1.25
1900	927	0.69	1019	0.84	1102	1.00	1179	1.18	1250	1.36
2000	965	0.78	1054	0.94	1135	1.11	1210	1.29	1280	1.48

CFM	AVAILABLE EXTERNAL STATIC PRESSURE (in. wg)									
	1.2		1.4		1.6		1.8		2.0	
	RPM	BHP	RPM	BHP	RPM	BHP	RPM	BHP	RPM	BHP
1200	1140	0.92	1210	1.10	1276	1.28	1339	1.47	-	-
1300	1162	0.99	1232	1.16	1297	1.35	-	-	-	-
1400	1186	1.06	1254	1.24	1319	1.43	-	-	-	-
1500	1210	1.14	1278	1.33	-	-	-	-	-	-
1600	1236	1.23	1302	1.42	-	-	-	-	-	-
1700	1262	1.33	-	-	-	-	-	-	-	-
1800	1289	1.44	-	-	-	-	-	-	-	-
1900	-	-	-	-	-	-	-	-	-	-
2000	-	-	-	-	-	-	-	-	-	-

NOTE: For more information, see General Fan Performance Notes.

Boldface indicates field-supplied drive is required.

Medium static 770–1175 RPM, 1.2 BHP max

High static 1035–1466 RPM, 1.5 BHP max

FAN PERFORMANCE (BELT DRIVE) (cont.)

Table 25 – 50KC-#05

3 PHASE

4 TON VERTICAL SUPPLY

CFM	AVAILABLE EXTERNAL STATIC PRESSURE (in. wg)									
	0.2		0.4		0.6		0.8		1.0	
	RPM	BHP	RPM	BHP	RPM	BHP	RPM	BHP	RPM	BHP
1200	695	0.25	818	0.37	930	0.51	1032	0.66	1126	0.83
1300	731	0.30	849	0.43	955	0.57	1053	0.72	1145	0.89
1400	769	0.36	880	0.49	982	0.63	1077	0.79	1166	0.97
1500	807	0.42	913	0.56	1011	0.71	1103	0.87	1188	1.05
1600	847	0.49	948	0.63	1042	0.79	1130	0.96	1213	1.14
1700	887	0.57	983	0.72	1073	0.88	1158	1.06	1239	1.24
1800	928	0.66	1020	0.82	1106	0.98	1188	1.16	1266	1.35
1900	969	0.76	1057	0.92	1140	1.09	1219	1.28	1295	1.48
2000	1010	0.87	1095	1.04	1175	1.21	1251	1.41	1325	1.61

50KC

CFM	AVAILABLE EXTERNAL STATIC PRESSURE (in. wg)									
	1.2		1.4		1.6		1.8		2.0	
	RPM	BHP	RPM	BHP	RPM	BHP	RPM	BHP	RPM	BHP
1200	1215	1.01	1298	1.21	1378	1.42	1454	1.64	1526	1.87
1300	1231	1.08	1313	1.28	1390	1.49	1465	1.71	1536	1.94
1400	1249	1.16	1329	1.36	1405	1.57	1478	1.79	1547	2.03
1500	1270	1.24	1347	1.45	1421	1.66	1492	1.89	1561	2.13
1600	1292	1.34	1367	1.54	1440	1.76	1509	1.99	1576	2.23
1700	1315	1.44	1389	1.65	1459	1.88	1527	2.11	1593	2.35
1800	1341	1.56	1412	1.77	1481	2.00	1547	2.23	1612	2.48
1900	1367	1.68	1437	1.90	1504	2.13	1569	2.37	1632	2.62
2000	1395	1.82	1463	2.04	1528	2.28	1591	2.52	1653	2.77

NOTE: For more information, see General Fan Performance Notes.
Boldface indicates field – supplied drive is required.

Medium static 920 – 1303 RPM, 1.7 BHP max
 High static 1208 – 1639 RPM, 2.9 BHP max

Table 26 – 50KC-#05

3 PHASE

4 TON HORIZONTAL SUPPLY

CFM	AVAILABLE EXTERNAL STATIC PRESSURE (in. wg)									
	0.2		0.4		0.6		0.8		1.0	
	RPM	BHP	RPM	BHP	RPM	BHP	RPM	BHP	RPM	BHP
1200	671	0.23	790	0.34	892	0.47	982	0.61	1064	0.76
1300	705	0.28	820	0.39	919	0.52	1007	0.67	1088	0.82
1400	740	0.33	851	0.45	947	0.58	1034	0.73	1113	0.89
1500	776	0.38	883	0.51	977	0.65	1061	0.80	1138	0.97
1600	813	0.45	916	0.58	1007	0.73	1089	0.89	1165	1.05
1700	851	0.52	949	0.66	1038	0.81	1118	0.97	1192	1.15
1800	888	0.60	984	0.75	1069	0.90	1148	1.07	1221	1.25
1900	927	0.69	1019	0.84	1102	1.00	1179	1.18	1250	1.36
2000	965	0.78	1054	0.94	1135	1.11	1210	1.29	1280	1.48

CFM	AVAILABLE EXTERNAL STATIC PRESSURE (in. wg)									
	1.2		1.4		1.6		1.8		2.0	
	RPM	BHP	RPM	BHP	RPM	BHP	RPM	BHP	RPM	BHP
1200	1140	0.92	1210	1.10	1276	1.28	1339	1.47	1399	1.68
1300	1162	0.99	1232	1.16	1297	1.35	1360	1.55	1419	1.75
1400	1186	1.06	1254	1.24	1319	1.43	1381	1.63	1439	1.84
1500	1210	1.14	1278	1.33	1342	1.52	1403	1.72	1461	1.93
1600	1236	1.23	1302	1.42	1365	1.62	1425	1.82	1483	2.04
1700	1262	1.33	1328	1.52	1390	1.72	1449	1.93	1505	2.15
1800	1289	1.44	1354	1.63	1415	1.84	1473	2.05	1529	2.27
1900	1317	1.55	1380	1.75	1441	1.96	1498	2.18	1553	2.41
2000	1345	1.68	1408	1.88	1467	2.10	1524	2.32	1579	2.55

NOTE: For more information, see General Fan Performance Notes.
Boldface indicates field – supplied drive is required.

Medium static 920 – 1303 RPM, 1.7 BHP max
 High static 1208 – 1639 RPM, 2.9 BHP max

FAN PERFORMANCE (BELT DRIVE) (cont.)

Table 27 – 50KC-*06

1 PHASE

5 TON VERTICAL SUPPLY

CFM	AVAILABLE EXTERNAL STATIC PRESSURE (in. wg)									
	0.2		0.4		0.6		0.8		1.0	
	RPM	BHP	RPM	BHP	RPM	BHP	RPM	BHP	RPM	BHP
1500	794	0.41	902	0.55	993	0.69	1074	0.85	1147	1.00
1625	840	0.49	945	0.64	1034	0.80	1113	0.96	1185	1.13
1750	888	0.59	988	0.75	1075	0.92	1153	1.09	1223	1.26
1875	936	0.70	1033	0.87	1117	1.05	1193	1.23	1263	1.41
2000	984	0.82	1078	1.00	1160	1.19	1235	1.39	–	–
2125	1033	0.96	1124	1.15	1204	1.35	–	–	–	–
2250	1083	1.11	1170	1.32	1248	1.53	–	–	–	–
2375	1133	1.28	1217	1.50	–	–	–	–	–	–
2500	1183	1.47	–	–	–	–	–	–	–	–

CFM	AVAILABLE EXTERNAL STATIC PRESSURE (in. wg)									
	1.2		1.4		1.6		1.8		2.0	
	RPM	BHP	RPM	BHP	RPM	BHP	RPM	BHP	RPM	BHP
1500	1214	1.16	1277	1.33	1336	1.50	–	–	–	–
1625	1251	1.30	1313	1.47	–	–	–	–	–	–
1750	1289	1.44	–	–	–	–	–	–	–	–
1875	–	–	–	–	–	–	–	–	–	–
2000	–	–	–	–	–	–	–	–	–	–
2125	–	–	–	–	–	–	–	–	–	–
2250	–	–	–	–	–	–	–	–	–	–
2375	–	–	–	–	–	–	–	–	–	–
2500	–	–	–	–	–	–	–	–	–	–

NOTE: For more information, see General Fan Performance Notes.

■ Medium static 1035–1466 RPM, 1.5 BHP max

Boldface indicates field-supplied drive is required.

50KC

Table 28 – 50KC-*06

1 PHASE

5 TON HORIZONTAL SUPPLY

CFM	AVAILABLE EXTERNAL STATIC PRESSURE (in. wg)									
	0.2		0.4		0.6		0.8		1.0	
	RPM	BHP	RPM	BHP	RPM	BHP	RPM	BHP	RPM	BHP
1500	725	0.33	840	0.46	937	0.60	1023	0.75	1101	0.90
1625	765	0.40	876	0.54	970	0.68	1054	0.84	1131	1.00
1750	806	0.48	912	0.63	1004	0.78	1087	0.94	1162	1.11
1875	847	0.57	950	0.72	1039	0.88	1120	1.05	1194	1.23
2000	889	0.66	988	0.83	1075	1.00	1154	1.18	1226	1.36
2125	931	0.78	1027	0.95	1112	1.13	1189	1.31	1260	1.50
2250	974	0.90	1067	1.08	1149	1.27	1224	1.46	–	–
2375	1018	1.03	1107	1.23	1187	1.43	–	–	–	–
2500	1061	1.19	1148	1.39	–	–	–	–	–	–

CFM	AVAILABLE EXTERNAL STATIC PRESSURE (in. wg)									
	1.2		1.4		1.6		1.8		2.0	
	RPM	BHP	RPM	BHP	RPM	BHP	RPM	BHP	RPM	BHP
1500	1172	1.06	1239	1.23	1302	1.40	–	–	–	–
1625	1201	1.16	1267	1.34	1329	1.52	–	–	–	–
1750	1231	1.28	1296	1.46	–	–	–	–	–	–
1875	1262	1.41	–	–	–	–	–	–	–	–
2000	–	–	–	–	–	–	–	–	–	–
2125	–	–	–	–	–	–	–	–	–	–
2250	–	–	–	–	–	–	–	–	–	–
2375	–	–	–	–	–	–	–	–	–	–
2500	–	–	–	–	–	–	–	–	–	–

NOTE: For more information, see General Fan Performance Notes.

■ Medium static 1035–1466 RPM, 1.5 BHP max

Boldface indicates field-supplied drive is required.

FAN PERFORMANCE (BELT DRIVE) (cont.)

Table 29 – 50KC-*06

3 PHASE

5 TON VERTICAL SUPPLY

CFM	AVAILABLE EXTERNAL STATIC PRESSURE (in. wg)									
	0.2		0.4		0.6		0.8		1.0	
	RPM	BHP	RPM	BHP	RPM	BHP	RPM	BHP	RPM	BHP
1500	794	0.41	902	0.55	993	0.69	1074	0.85	1147	1.00
1625	840	0.49	945	0.64	1034	0.80	1113	0.96	1185	1.13
1750	888	0.59	988	0.75	1075	0.92	1153	1.09	1223	1.26
1875	936	0.70	1033	0.87	1117	1.05	1193	1.23	1263	1.41
2000	984	0.82	1078	1.00	1160	1.19	1235	1.39	1303	1.58
2125	1033	0.96	1124	1.15	1204	1.35	1277	1.56	1343	1.76
2250	1083	1.11	1170	1.32	1248	1.53	1319	1.74	1385	1.96
2375	1133	1.28	1217	1.50	1293	1.72	1363	1.95	1427	2.17
2500	1183	1.47	1265	1.70	1339	1.93	1406	2.17	1470	2.41

50KC

CFM	AVAILABLE EXTERNAL STATIC PRESSURE (in. wg)									
	1.2		1.4		1.6		1.8		2.0	
	RPM	BHP	RPM	BHP	RPM	BHP	RPM	BHP	RPM	BHP
1500	1214	1.16	1277	1.33	1336	1.50	1392	1.67	1445	1.85
1625	1251	1.30	1313	1.47	1371	1.65	1427	1.83	1479	2.02
1750	1289	1.44	1350	1.63	1407	1.81	1462	2.01	1514	2.20
1875	1327	1.60	1387	1.80	1444	1.99	1498	2.19	1550	2.40
2000	1366	1.78	1426	1.98	1482	2.19	1535	2.40	1586	2.61
2125	1406	1.97	1464	2.18	1520	2.40	1573	2.62	1623	2.84
2250	1446	2.18	1504	2.40	1559	2.62	1611	2.85	1661	3.09
2375	1487	2.40	1544	2.63	1598	2.87	1650	3.11	–	–
2500	1529	2.64	1585	2.89	1638	3.13	–	–	–	–

NOTE: For more information, see General Fan Performance Notes.
Boldface indicates field-supplied drive is required.

Medium static 1035 – 1466 RPM, 2.9 BHP max
 High static 1303 – 1687 RPM, 2.9 BHP max

Table 30 – 50KC-*06

3 PHASE

5 TON HORIZONTAL SUPPLY

CFM	AVAILABLE EXTERNAL STATIC PRESSURE (in. wg)									
	0.2		0.4		0.6		0.8		1.0	
	RPM	BHP	RPM	BHP	RPM	BHP	RPM	BHP	RPM	BHP
1500	725	0.33	840	0.46	937	0.60	1023	0.75	1101	0.90
1625	765	0.40	876	0.54	970	0.68	1054	0.84	1131	1.00
1750	806	0.48	912	0.63	1004	0.78	1087	0.94	1162	1.11
1875	847	0.57	950	0.72	1039	0.88	1120	1.05	1194	1.23
2000	889	0.66	988	0.83	1075	1.00	1154	1.18	1226	1.36
2125	931	0.78	1027	0.95	1112	1.13	1189	1.31	1260	1.50
2250	974	0.90	1067	1.08	1149	1.27	1224	1.46	1294	1.66
2375	1018	1.03	1107	1.23	1187	1.43	1261	1.63	1329	1.84
2500	1061	1.19	1148	1.39	1226	1.59	1297	1.81	1364	2.02

CFM	AVAILABLE EXTERNAL STATIC PRESSURE (in. wg)									
	1.2		1.4		1.6		1.8		2.0	2.0
	RPM	BHP	RPM	BHP	RPM	BHP	RPM	BHP	RPM	BHP
1500	1172	1.06	1239	1.23	1302	1.40	1361	1.58	1418	1.77
1625	1201	1.16	1267	1.34	1329	1.52	1388	1.71	1444	1.90
1750	1231	1.28	1296	1.46	1358	1.65	1416	1.84	1472	2.04
1875	1262	1.41	1326	1.60	1387	1.79	1445	1.99	1499	2.20
2000	1294	1.55	1357	1.74	1417	1.95	1474	2.15	1528	2.36
2125	1326	1.70	1388	1.90	1447	2.11	1504	2.33	1557	2.55
2250	1359	1.87	1420	2.08	1479	2.29	1534	2.51	1587	2.74
2375	1393	2.05	1453	2.27	1511	2.49	1566	2.72	1618	2.95
2500	1427	2.24	1487	2.47	1543	2.70	1597	2.94	1649	3.18

NOTE: For more information, see General Fan Performance Notes.
Boldface indicates field-supplied drive is required.

Medium static 1035 – 1466 RPM, 2.9 BHP max
 High static 1303 – 1687 RPM, 2.9 BHP max

FAN PERFORMANCE (cont.)

Table 31 – PULLEY ADJUSTMENT - BELT DRIVE

UNIT		MOTOR/DRIVE COMBO	MOTOR PULLEY TURNS OPEN										
			0	0.5	1	1.5	2	2.5	3	3.5	4	4.5	5
04	1 phase	Medium Static	1175	1135	1094	1054	1013	973	932	892	851	811	770
		High Static	1466	1423	1380	1337	1294	1251	1207	1164	1121	1078	1035
05		Medium Static	1175	1135	1094	1054	1013	973	932	892	851	811	770
		High Static	1466	1423	1380	1337	1294	1251	1207	1164	1121	1078	1035
06		Medium Static	1466	1423	1380	1337	1294	1251	1207	1164	1121	1078	1035
		High Static	N/A	N/A	N/A	N/A	N/A	N/A	N/A	N/A	N/A	N/A	N/A
04	3 phase	Medium Static	1175	1135	1094	1054	1013	973	932	892	851	811	770
		High Static	1466	1423	1380	1337	1294	1251	1207	1164	1121	1078	1035
05		Medium Static	1303	1265	1226	1188	1150	1112	1073	1035	997	958	920
		High Static	1639	1596	1553	1510	1467	1424	1380	1337	1294	1251	1208
06		Medium Static	1466	1423	1380	1337	1294	1251	1207	1164	1121	1078	1035
		High Static	1687	1649	1610	1572	1533	1495	1457	1418	1380	1341	1303

NOTE: Do not adjust pulley further than 5 turns open.

■ – Factory settings

N/A – Not Available

50KC

ELECTRICAL INFORMATION

Table 32 – 50KC-*04 SINGLE STAGE COOLING WITH SINGLE SPEED INDOOR FAN MOTOR 3 TONS

V-Ph-Hz	UNIT VOLTAGE		COMP 1		OFM (ea)		IFM		
	RANGE		RLA	LRA	WATTS	FLA	TYPE	EFF at Full Load	FLA
	MIN	MAX							
208-1-60	187	253	16.6	79	190	1.0	DD-STD	78%	7.4
					190	1.0	MED	67%	4.9
					190	1.0	HIGH	76%	7.0
230-1-60	187	253	16.6	79	190	1.0	DD-STD	78%	7.4
					190	1.0	MED	67%	4.9
					190	1.0	HIGH	76%	7.0
208-3-60	187	253	10.4	73	190	1.0	DD-STD	78%	7.4
					190	1.0	MED	87%	5.2
					190	1.0	HIGH	89%	8.4
230-3-60	187	253	10.4	73	190	1.0	DD-STD	78%	7.4
					190	1.0	MED	87%	4.9
					190	1.0	HIGH	89%	8.3
460-3-60	414	506	5.8	38	190	0.5	DD-STD	78%	4.0
					190	0.5	MED	87%	2.5
					190	0.5	HIGH	89%	4.2
575-3-60	518	633	3.8	37	190	0.5	DD-STD	78%	4.0
					190	0.5	MED	72%	1.6
					190	0.5	HIGH	77%	2.8

50KC

Table 33 – 50KC-*05 SINGLE STAGE COOLING WITH SINGLE SPEED INDOOR FAN MOTOR 4 TONS

V-Ph-Hz	UNIT VOLTAGE		COMP 1		OFM (ea)		IFM		
	RANGE		RLA	LRA	WATTS	FLA	TYPE	EFF at Full Load	FLA
	MIN	MAX							
208-1-60	187	253	21.8	117	325	1.5	DD-STD	78%	7.4
					325	1.5	MED	67%	4.9
					325	1.5	HIGH	76%	7.0
230-1-60	187	253	21.8	117	325	1.5	DD-STD	78%	7.4
					325	1.5	MED	67%	4.9
					325	1.5	HIGH	76%	7.0
208-3-60	187	253	13.7	83	325	1.5	DD-STD	78%	7.4
					325	1.5	MED	87%	5.2
					325	1.5	HIGH	89%	8.4
230-3-60	187	253	13.7	83	325	1.5	DD-STD	78%	7.4
					325	1.5	MED	87%	4.9
					325	1.5	HIGH	89%	8.3
460-3-60	414	506	6.2	41	325	0.8	DD-STD	78%	4.0
					325	0.8	MED	87%	2.5
					325	0.8	HIGH	89%	4.2
575-3-60	518	633	4.8	33	325	0.6	DD-STD	78%	4.0
					325	0.6	MED	72%	1.6
					325	0.6	HIGH	77%	2.8

Table 34 – 50KC-*06 SINGLE STAGE COOLING WITH SINGLE SPEED INDOOR FAN MOTOR 5 TONS

V-Ph-Hz	UNIT VOLTAGE		COMP 1		OFM (ea)		IFM		
	RANGE		RLA	LRA	WATTS	FLA	TYPE	EFF at Full Load	FLA
	MIN	MAX							
208-1-60	187	253	25.0	134	325	1.4	DD-STD	78%	7.4
					325	1.4	MED	76%	7.0
230-1-60	187	253	25.0	134	325	1.4	DD-STD	78%	7.4
					325	1.4	MED	76%	7.0
208-3-60	187	253	15.9	110	325	1.4	DD-STD	78%	7.4
					325	1.4	MED	89%	8.4
					325	1.4	HIGH	89%	8.4
230-3-60	187	253	15.9	110	325	1.4	DD-STD	78%	7.4
					325	1.4	MED	89%	8.3
					325	1.4	HIGH	89%	8.3
460-3-60	414	506	7.0	52	325	0.9	DD-STD	78%	4.0
					325	0.9	MED	89%	4.2
					325	0.9	HIGH	89%	4.2
575-3-60	518	633	5.1	40	325	0.9	DD-STD	78%	4.0
					325	0.9	MED	77%	2.8
					325	0.9	HIGH	77%	2.8

ELECTRIC HEAT - ELECTRICAL INFORMATION

Table 35 – 50KC**04

WITHOUT FACTORY INSTALLED NON-FUSED DISCONNECT

NOM. V-PH-Hz.	IFM TYPE	ELECTRIC HEATER PART NUMBER CRHEATERXXXXXX	NOM PWR (kW)	APP PWR (kW)	SINGLE POINT KIT PART NUMBER CRSINGLEXXXXXX			
					NO C.O. or UNPWRD C.O.		w/PWRD C.O.	
					NO P.E.	w/P.E. (pwrd fr/unit)	NO P.E.	w/P.E. (pwrd fr/unit)
208/230-1-60	DD-STD	101A00	4.4	3.3/4.0	-	-	NA	NA
		102A00	6.5	4.9/6.0	-	-	NA	NA
		103B00	8.7	6.5/8.0	037	037	NA	NA
		104B00	10.5	7.9/9.6	040	040	NA	NA
		102A00,102A00	13.0	9.8/11.9	040	040	NA	NA
	MED	101A00	4.4	3.3/4.0	-	-	NA	NA
		102A00	6.5	4.9/6.0	-	-	NA	NA
		103B00	8.7	6.5/8.0	037	037	NA	NA
		104B00	10.5	7.9/9.6	040	040	NA	NA
		102A00,102A00	13.0	9.8/11.9	040	040	NA	NA
	HIGH	101A00	4.4	3.3/4.0	-	-	NA	NA
		102A00	6.5	4.9/6.0	-	-	NA	NA
103B00		8.7	6.5/8.0	037	037	NA	NA	
104B00		10.5	7.9/9.6	040	040	NA	NA	
102A00,102A00		13.0	9.8/11.9	040	040	NA	NA	
208/230-3-60	DD-STD	101A00	4.4	3.3/4.0	-	-	-	-
		102A00	6.5	4.9/6.0	-	-	-	-
		103B00	8.7	6.5/8.0	-	-	-	-
		104B00	10.5	7.9/9.6	-	-	-	-
		105A00	16.0	12.0/14.7	037	037	038	038
	MED	101A00	4.4	3.3/4.0	-	-	-	-
		102A00	6.5	4.9/6.0	-	-	-	-
		103B00	8.7	6.5/8.0	-	-	-	-
		104B00	10.5	7.9/9.6	-	-	-	-
		105A00	16.0	12.0/14.7	037	037	038	038
	HIGH	101A00	4.4	3.3/4.0	-	-	-	-
		102A00	6.5	4.9/6.0	-	-	-	-
		103B00	8.7	6.5/8.0	-	-	-	-
		104B00	10.5	7.9/9.6	-	-	-	037
		105A00	16.0	12.0/14.7	037	038	038	038
460-3-60	DD-STD	106A00	6.0	5.5	-	-	-	-
		107A00	8.8	8.1	-	-	-	-
		108A00	11.5	10.6	-	-	-	-
		109A00	14.0	12.9	-	-	-	-
	MED	106A00	6.0	5.5	-	-	-	-
		107A00	8.8	8.1	-	-	-	-
		108A00	11.5	10.6	-	-	-	-
		109A00	14.0	12.9	-	-	-	-
	HIGH	106A00	6.0	5.5	-	-	-	-
		107A00	8.8	8.1	-	-	-	-
		108A00	11.5	10.6	-	-	-	-
		109A00	14.0	12.9	-	-	-	-

50KC

LEGEND:

- No Single Point Kit required
- APP PWR - 208 / 230V / 460V / 575V
- C.O. - Convenience outlet
- IFM - Indoor fan motor
- NA - Not Available
- NOM PWR - 240V / 480V / 600V
- P.E. - Power exhaust
- PWRD - Powered convenience outlet
- UNPWRD - Unpowered convenience outlet

ELECTRIC HEAT - ELECTRICAL INFORMATION

Table 36 – 50KC05**

WITHOUT FACTORY INSTALLED NON-FUSED DISCONNECT

50KC

NOM. V-PH-Hz.	IFM TYPE	ELECTRIC HEATER PART NUMBER CRHEATERXXXXXX	NOM PWR (kW)	APP PWR (kW)	SINGLE POINT KIT PART NUMBER CRSINGLEXXXXXX			
					NO C.O. or UNPWRD C.O.		w/PWRD C.O.	
					NO P.E.	w/P.E. (pwr fr/unit)	NO P.E.	w/P.E. (pwr fr/unit)
208/230-1-60	DD-STD	101A00	4.4	3.3/4.0	-	-	NA	NA
		103B00	8.7	6.5/8.0	037	037	NA	NA
		102A00,102A00	13.0	9.8/11.9	040	040	NA	NA
		103B00,103B00	17.4	13.1/16.0	040	040	NA	NA
		104B00,104B00	21.0	15.8/19.3	040	040	NA	NA
	MED	101A00	4.4	3.3/4.0	-	-	NA	NA
		103B00	8.7	6.5/8.0	037	037	NA	NA
		102A00,102A00	13.0	9.8/11.9	040	040	NA	NA
		103B00,103B00	17.4	13.1/16.0	040	040	NA	NA
		104B00,104B00	21.0	15.8/19.3	040	040	NA	NA
	HIGH	101A00	4.4	3.3/4.0	-	-	NA	NA
		103B00	8.7	6.5/8.0	037	037	NA	NA
102A00,102A00		13.0	9.8/11.9	040	040	NA	NA	
103B00,103B00		17.4	13.1/16.0	040	040	NA	NA	
104B00,104B00		21.0	15.8/19.3	040	040	NA	NA	
208/230-3-60	DD-STD	102A00	6.5	4.9/6.0	-	-	-	-
		103B00	8.7	6.5/8.0	-	-	-	-
		105A00	16.0	12.0/14.7	037	037	038	038
		104B00,104B00	21.0	15.8/19.3	038	038	038	038
	MED	102A00	6.5	4.9/6.0	-	-	-	-
		103B00	8.7	6.5/8.0	-	-	-	-
		105A00	16.0	12.0/14.7	037	037	038	038
		104B00,104B00	21.0	15.8/19.3	038	038	038	038
	HIGH	102A00	6.5	4.9/6.0	-	-	-	-
		103B00	8.7	6.5/8.0	-	-	-	-
		105A00	16.0	12.0/14.7	037	038	038	038
		104B00,104B00	21.0	15.8/19.3	038	038	038	038
460-3-60	DD-STD	106A00	6.0	5.5	-	-	-	-
		108A00	11.5	10.6	-	-	-	-
		109A00	14.0	12.9	-	-	-	-
		108A00,108A00	23.0	21.1	037	037	037	037
	MED	106A00	6.0	5.5	-	-	-	-
		108A00	11.5	10.6	-	-	-	-
		109A00	14.0	12.9	-	-	-	-
		108A00,108A00	23.0	21.1	037	037	037	037
	HIGH	106A00	6.0	5.5	-	-	-	-
		108A00	11.5	10.6	-	-	-	-
		109A00	14.0	12.9	-	-	-	-
		108A00,108A00	23.0	21.1	037	037	037	037

LEGEND:

- No Single Point Kit required
- APP PWR - 208 / 230V / 460V / 575V
- C.O. - Convenience outlet
- IFM - Indoor fan motor
- NA - Not Available
- NOM PWR - 240V / 480V / 600V
- P.E. - Power exhaust
- PWRD - Powered convenience outlet
- UNPWRD - Unpowered convenience outlet

ELECTRIC HEAT - ELECTRICAL INFORMATION

Table 37 – 50KC06**

WITHOUT FACTORY INSTALLED NON-FUSED DISCONNECT

NOM. V-PH-Hz.	IFM TYPE	ELECTRIC HEATER PART NUMBER CRHEATERXXXXXX	NOM PWR (kW)	APP PWR (kW)	SINGLE POINT KIT PART NUMBER CRSINGLEXXXXXX			
					NO C.O. or UNPWRD C.O.		w/PWRD C.O.	
					NO P.E.	w/P.E. (pwrd fr/unit)	NO P.E.	w/P.E. (pwrd fr/unit)
208/230-1-60	DD-STD	102A00	6.5	4.9/6.0	-	-	NA	NA
		103B00	8.7	6.5/8.0	037	037	NA	NA
		102A00,102A00	13.0	9.8/11.9	040	040	NA	NA
		103B00,103B00	17.4	13.1/16.0	040	040	NA	NA
		104B00,104B00	21.0	15.8/19.3	040	040	NA	NA
	MED	102A00	6.5	4.9/6.0	-	-	NA	NA
		103B00	8.7	6.5/8.0	037	037	NA	NA
		102A00,102A00	13.0	9.8/11.9	040	040	NA	NA
		103B00,103B00	17.4	13.1/16.0	040	040	NA	NA
		104B00,104B00	21.0	15.8/19.3	040	040	NA	NA
208/230-3-60	DD-STD	102A00	6.5	4.9/6.0	-	-	-	-
		104B00	10.5	7.9/9.6	-	-	-	-
		105A00	16.0	12.0/14.7	037	037	038	038
		104B00,104B00	21.0	15.8/19.3	038	038	038	038
		104B00,105A00	26.5	19.9/24.3	038	038	038	038
	MED	102A00	6.5	4.9/6.0	-	-	-	-
		104B00	10.5	7.9/9.6	-	-	-	037
		105A00	16.0	12.0/14.7	037	038	038	038
		104B00,104B00	21.0	15.8/19.3	038	038	038	038
		104B00,105A00	26.5	19.9/24.3	038	038	038	038
	HIGH	102A00	6.5	4.9/6.0	-	-	-	-
		104B00	10.5	7.9/9.6	-	-	-	037
		105A00	16.0	12.0/14.7	037	038	038	038
		104B00,104B00	21.0	15.8/19.3	038	038	038	038
		104B00,105A00	26.5	19.9/24.3	038	038	038	038
460-3-60	DD-STD	106A00	6.0	5.5	-	-	-	-
		108A00	11.5	10.6	-	-	-	-
		109A00	14.0	12.9	-	-	-	-
		108A00,108A00	23.0	21.1	037	037	037	037
		108A00,109A00	25.5	23.4	037	037	037	037
	MED	106A00	6.0	5.5	-	-	-	-
		108A00	11.5	10.6	-	-	-	-
		109A00	14.0	12.9	-	-	-	-
		108A00,108A00	23.0	21.1	037	037	037	037
		108A00,109A00	25.5	23.4	037	037	037	037
	HIGH	106A00	6.0	5.5	-	-	-	-
		108A00	11.5	10.6	-	-	-	-
		109A00	14.0	12.9	-	-	-	-
		108A00,108A00	23.0	21.1	037	037	037	037
		108A00,109A00	25.5	23.4	037	037	037	037

50KC

LEGEND:

- No Single Point Kit required
- APP PWR - 208 / 230V / 460V / 575V
- C.O. - Convenience outlet
- IFM - Indoor fan motor
- NA - Not Available
- NOM PWR - 240V / 480V / 600V
- P.E. - Power exhaust
- PWRD - Powered convenience outlet
- UNPWRD - Unpowered convenience outlet

ELECTRIC HEAT - ELECTRICAL INFORMATION

Table 38 – 50KC**04

WITH FACTORY INSTALLED NON-FUSED DISCONNECT

50KC

NOM. V-PH-Hz.	IFM TYPE	ELECTRIC HEATER PART NUMBER CRHEATERXXXXXX	NOM PWR (kW)	APP PWR (kW)	SINGLE POINT KIT PART NUMBER CRSINGLEXXXXXX			
					NO C.O. or UNPWRD C.O.		w/PWRD C.O.	
					NO P.E.	w/P.E. (pwr fr/unit)	NO P.E.	w/P.E. (pwr fr/unit)
208/230-1-60	DD-STD	101A00	4.4	3.3/4.0	037	037	NA	NA
		102A00	6.5	4.9/6.0	037	037	NA	NA
		103B00	8.7	6.5/8.0	037	037	NA	NA
		104B00	10.5	7.9/9.6	040	040	NA	NA
		102A00,102A00	13.0	9.8/11.9	040	040	NA	NA
	MED	101A00	4.4	3.3/4.0	037	037	NA	NA
		102A00	6.5	4.9/6.0	037	037	NA	NA
		103B00	8.7	6.5/8.0	037	037	NA	NA
		104B00	10.5	7.9/9.6	040	040	NA	NA
		102A00,102A00	13.0	9.8/11.9	040	040	NA	NA
	HIGH	101A00	4.4	3.3/4.0	037	037	NA	NA
		102A00	6.5	4.9/6.0	037	037	NA	NA
103B00		8.7	6.5/8.0	037	037	NA	NA	
104B00		10.5	7.9/9.6	040	040	NA	NA	
102A00,102A00		13.0	9.8/11.9	040	040	NA	NA	
208/230-3-60	DD-STD	101A00	4.4	3.3/4.0	037	037	037	037
		102A00	6.5	4.9/6.0	037	037	037	037
		103B00	8.7	6.5/8.0	037	037	037	037
		104B00	10.5	7.9/9.6	037	037	037	037
		105A00	16.0	12.0/14.7	037	037	038	038
	MED	101A00	4.4	3.3/4.0	037	037	037	037
		102A00	6.5	4.9/6.0	037	037	037	037
		103B00	8.7	6.5/8.0	037	037	037	037
		104B00	10.5	7.9/9.6	037	037	037	037
		105A00	16.0	12.0/14.7	037	037	038	038
	HIGH	101A00	4.4	3.3/4.0	037	037	037	037
		102A00	6.5	4.9/6.0	037	037	037	037
		103B00	8.7	6.5/8.0	037	037	037	037
		104B00	10.5	7.9/9.6	037	037	037	037
		105A00	16.0	12.0/14.7	037	038	038	038
460-3-60	DD-STD	106A00	6.0	5.5	-	-	-	-
		107A00	8.8	8.1	-	-	-	-
		108A00	11.5	10.6	-	-	-	-
		109A00	14.0	12.9	-	-	-	-
	MED	106A00	6.0	5.5	-	-	-	-
		107A00	8.8	8.1	-	-	-	-
		108A00	11.5	10.6	-	-	-	-
		109A00	14.0	12.9	-	-	-	-
	HIGH	106A00	6.0	5.5	-	-	-	-
		107A00	8.8	8.1	-	-	-	-
		108A00	11.5	10.6	-	-	-	-
		109A00	14.0	12.9	-	-	-	-

LEGEND:

- No Single Point Kit required
- APP PWR - 208 / 230V / 460V / 575V
- C.O. - Convenience outlet
- IFM - Indoor fan motor
- NA - Not Available
- NOM PWR - 240V / 480V / 600V
- P.E. - Power exhaust
- PWRD - Powered convenience outlet
- UNPWRD - Unpowered convenience outlet

ELECTRIC HEAT - ELECTRICAL INFORMATION

Table 39 – 50KC05**

WITH FACTORY INSTALLED NON-FUSED DISCONNECT

NOM. V-PH-Hz.	IFM TYPE	ELECTRIC HEATER PART NUMBER CRHEATERXXXXXX	NOM PWR (kW)	APP PWR (kW)	SINGLE POINT KIT PART NUMBER CRSINGLEXXXXXX			
					NO C.O. or UNPWRD C.O.		w/PWRD C.O.	
					NO P.E.	w/P.E. (pwrd fr/unit)	NO P.E.	w/P.E. (pwrd fr/unit)
208/230-1-60	DD-STD	101A00	4.4	3.3/4.0	037	037	NA	NA
		103B00	8.7	6.5/8.0	037	037	NA	NA
		102A00,102A00	13.0	9.8/11.9	040	040	NA	NA
		103B00,103B00	17.4	13.1/16.0	040	040	NA	NA
		104B00,104B00	21.0	15.8/19.3	040	040	NA	NA
	MED	101A00	4.4	3.3/4.0	037	037	NA	NA
		103B00	8.7	6.5/8.0	037	037	NA	NA
		102A00,102A00	13.0	9.8/11.9	040	040	NA	NA
		103B00,103B00	17.4	13.1/16.0	040	040	NA	NA
		104B00,104B00	21.0	15.8/19.3	040	040	NA	NA
	HIGH	101A00	4.4	3.3/4.0	037	037	NA	NA
		103B00	8.7	6.5/8.0	037	037	NA	NA
		102A00,102A00	13.0	9.8/11.9	040	040	NA	NA
		103B00,103B00	17.4	13.1/16.0	040	040	NA	NA
		104B00,104B00	21.0	15.8/19.3	040	040	NA	NA
208/230-3-60	DD-STD	102A00	6.5	4.9/6.0	037	037	037	037
		103B00	8.7	6.5/8.0	037	037	037	037
		105A00	16.0	12.0/14.7	037	037	038	038
		104B00,104B00	21.0	15.8/19.3	038	038	038	038
	MED	102A00	6.5	4.9/6.0	037	037	037	037
		103B00	8.7	6.5/8.0	037	037	037	037
		105A00	16.0	12.0/14.7	037	037	038	038
		104B00,104B00	21.0	15.8/19.3	038	038	038	038
	HIGH	102A00	6.5	4.9/6.0	037	037	037	037
		103B00	8.7	6.5/8.0	037	037	037	037
		105A00	16.0	12.0/14.7	037	038	038	038
		104B00,104B00	21.0	15.8/19.3	038	038	038	038
460-3-60	DD-STD	106A00	6.0	5.5	-	-	-	-
		108A00	11.5	10.6	-	-	-	-
		109A00	14.0	12.9	-	-	-	-
		108A00,108A00	23.0	21.1	037	037	037	037
	MED	106A00	6.0	5.5	-	-	-	-
		108A00	11.5	10.6	-	-	-	-
		109A00	14.0	12.9	-	-	-	-
		108A00,108A00	23.0	21.1	037	037	037	037
	HIGH	106A00	6.0	5.5	-	-	-	-
		108A00	11.5	10.6	-	-	-	-
		109A00	14.0	12.9	-	-	-	-
		108A00,108A00	23.0	21.1	037	037	037	037

50KC

LEGEND:

- No Single Point Kit required
- APP PWR - 208 / 230V / 460V / 575V
- C.O. - Convenience outlet
- IFM - Indoor fan motor
- NA - Not Available
- NOM PWR - 240V / 480V / 600V
- P.E. - Power exhaust
- PWRD - Powered convenience outlet
- UNPWRD - Unpowered convenience outlet

ELECTRIC HEAT - ELECTRICAL INFORMATION

Table 40 – 50KC06**

WITH FACTORY INSTALLED NON-FUSED DISCONNECT

50KC

NOM. V-PH-Hz.	IFM TYPE	ELECTRIC HEATER PART NUMBER CRHEATERXXXXXX	NOM PWR (kW)	APP PWR (kW)	SINGLE POINT KIT PART NUMBER CRSINGLEXXXXXX			
					NO C.O. or UNPWRD C.O.		w/PWRD C.O.	
					NO P.E.	w/P.E. (pwr fr/unit)	NO P.E.	w/P.E. (pwr fr/unit)
208/230-1-60	DD-STD	102A00	6.5	4.9/6.0	037	037	NA	NA
		103B00	8.7	6.5/8.0	037	037	NA	NA
		102A00,102A00	13.0	9.8/11.9	040	040	NA	NA
		103B00,103B00	17.4	13.1/16.0	040	040	NA	NA
		104B00,104B00	21.0	15.8/19.3	040	040	NA	NA
	MED	102A00	6.5	4.9/6.0	037	037	NA	NA
		103B00	8.7	6.5/8.0	037	037	NA	NA
		102A00,102A00	13.0	9.8/11.9	040	040	NA	NA
		103B00,103B00	17.4	13.1/16.0	040	040	NA	NA
		104B00,104B00	21.0	15.8/19.3	040	040	NA	NA
208/230-3-60	DD-STD	102A00	6.5	4.9/6.0	037	037	037	037
		104B00	10.5	7.9/9.6	037	037	037	037
		105A00	16.0	12.0/14.7	037	037	038	038
		104B00,104B00	21.0	15.8/19.3	038	038	038	038
		104B00,105A00	26.5	19.9/24.3	038	038	038	038
	MED	102A00	6.5	4.9/6.0	037	037	037	037
		104B00	10.5	7.9/9.6	037	037	037	037
		105A00	16.0	12.0/14.7	037	038	038	038
		104B00,104B00	21.0	15.8/19.3	038	038	038	038
		104B00,105A00	26.5	19.9/24.3	038	038	038	038
	HIGH	102A00	6.5	4.9/6.0	037	037	037	037
		104B00	10.5	7.9/9.6	037	037	037	037
		105A00	16.0	12.0/14.7	037	038	038	038
		104B00,104B00	21.0	15.8/19.3	038	038	038	038
		104B00,105A00	26.5	19.9/24.3	038	038	038	038
460-3-60	DD-STD	106A00	6.0	5.5	-	-	-	-
		108A00	11.5	10.6	-	-	-	-
		109A00	14.0	12.9	-	-	-	-
		108A00,108A00	23.0	21.1	037	037	037	037
		108A00,109A00	25.5	23.4	037	037	037	037
	MED	106A00	6.0	5.5	-	-	-	-
		108A00	11.5	10.6	-	-	-	-
		109A00	14.0	12.9	-	-	-	-
		108A00,108A00	23.0	21.1	037	037	037	037
		108A00,109A00	25.5	23.4	037	037	037	037
	HIGH	106A00	6.0	5.5	-	-	-	-
		108A00	11.5	10.6	-	-	-	-
		109A00	14.0	12.9	-	-	-	-
		108A00,108A00	23.0	21.1	037	037	037	037
		108A00,109A00	25.5	23.4	037	037	037	037

LEGEND:

- No Single Point Kit required
- APP PWR - 208 / 230V / 460V / 575V
- C.O. - Convenience outlet
- IFM - Indoor fan motor
- NA - Not Available
- NOM PWR - 240V / 480V / 600V
- P.E. - Power exhaust
- PWRD - Powered convenience outlet
- UNPWRD - Unpowered convenience outlet

ELECTRICAL INFORMATION

Table 41 – UNIT WIRE/FUSE OR HACR BREAKER SIZING DATA

UNIT	NO M. V.-Ph-HZ	ELEC. HTR					NO C.O. or UNPWR C.O.					NO PE.					w/ PWRD C.O.					
		IFM TYPE	CRHEATER***A00	Nom (kW)	FLA	MCA	MAX FUSE or BRKR	DISC. SIZE		MCA	MAX FUSE or BRKR	DISC. SIZE		MCA	MAX FUSE or BRKR	DISC. SIZE		MCA	MAX FUSE or BRKR	DISC. SIZE		
								FLA	LRA			FLA	LRA			FLA	LRA			FLA	LRA	FLA
DD - STD		NONE	---	---	---	30	45	29	88	32	45	31	90	---	---	---	---	---	---	---	---	---
		101A	3.3/4.4	15.9/18.3	30/33	45/45	29/30	88/88	32/35	45/45	31/32	90/90	---	---	---	---	---	---	---	---	---	---
		102A	4.9/6.5	23.5/27.1	39/44	45/45	36/40	88/88	41/46	45/50	38/42	90/90	---	---	---	---	---	---	---	---	---	---
		103B	6.5/8.7	31.4/36.3	49/55	50/60	45/50	88/88	51/57	60/60	47/52	90/90	---	---	---	---	---	---	---	---	---	---
		104B 102A+102A	7.9/10.5 9.8/13.0	37.9/43.8 46.9/54.2	57/64 68/77	60/70 70/80	52/59 62/71	88/88 88/88	59/67 71/80	60/70 80/80	54/61 65/73	90/90 90/90	---	---	---	---	---	---	---	---	---	---
MED	208/230-1-60	NONE	---	---	---	27	40	26	93	29	45	28	95	---	---	---	---	---	---	---	---	---
		101A	3.3/4.4	15.9/18.3	27/29	40/40	26/27	93/93	29/32	45/45	28/29	95/95	---	---	---	---	---	---	---	---	---	---
		102A	4.9/6.5	23.5/27.1	36/40	40/45	33/37	93/93	38/43	45/45	35/39	95/95	---	---	---	---	---	---	---	---	---	---
		103B	6.5/8.7	31.4/36.3	48/52	50/60	42/47	93/93	48/54	50/60	44/50	95/95	---	---	---	---	---	---	---	---	---	---
		104B 102A+102A	7.9/10.5 9.8/13.0	37.9/43.8 46.9/54.2	54/61 65/74	60/70 70/80	49/56 60/68	93/93 93/93	56/64 68/77	60/70 70/80	51/58 62/70	95/95 95/95	---	---	---	---	---	---	---	---	---	---
HIGH		NONE	---	---	---	29	45	28	118	31	45	30	120	---	---	---	---	---	---	---	---	---
		101A	3.3/4.4	15.9/18.3	29/32	45/45	28/29	118/118	31/34	45/45	30/31	120/120	---	---	---	---	---	---	---	---	---	---
		102A	4.9/6.5	23.5/27.1	39/43	45/45	35/39	118/118	41/45	45/50	37/41	120/120	---	---	---	---	---	---	---	---	---	---
		103B	6.5/8.7	31.4/36.3	48/55	50/60	44/50	118/118	51/57	60/60	46/52	120/120	---	---	---	---	---	---	---	---	---	---
		104B 102A+102A	7.9/10.5 9.8/13.0	37.9/43.8 46.9/54.2	57/64 68/77	60/70 70/80	52/58 62/70	118/118 118/118	59/66 70/79	60/70 70/80	54/61 64/73	120/120 120/120	---	---	---	---	---	---	---	---	---	---
DD - STD		NONE	---	---	---	22	30	22	82	24	30	24	84	---	---	---	---	---	---	---	---	---
		101A	3.3/4.4	9.2/10.6	22/23	30/30	22/22	82/82	24/25	30/30	24/24	84/84	---	---	---	---	---	---	---	---	---	---
		102A	4.9/6.5	13.6/15.6	27/29	30/30	24/26	82/82	29/32	30/35	26/29	84/84	---	---	---	---	---	---	---	---	---	---
		103B	6.5/8.7	18.1/20.9	32/36	35/40	29/33	82/82	35/38	35/40	32/35	84/84	---	---	---	---	---	---	---	---	---	---
		104B 105A	7.9/10.5 12.0/16.0	21.9/25.3 33.4/38.5	37/41 51/58	40/45 60/60	34/38 47/53	82/82 82/82	39/44 54/60	40/45 60/60	36/40 49/55	84/84 84/84	---	---	---	---	---	---	---	---	---	---
MED	208/230-3-60	NONE	---	---	---	20/19	25/25	19/19	111	22/21	30/30	21/21	113	---	---	---	---	---	---	---	---	---
		101A	3.3/4.4	9.2/10.6	20/20	25/25	19/19	111/111	22/22	30/30	21/21	113/113	---	---	---	---	---	---	---	---	---	---
		102A	4.9/6.5	13.6/15.6	24/26	25/30	22/24	111/111	26/28	30/30	24/26	113/113	---	---	---	---	---	---	---	---	---	---
		103B	6.5/8.7	18.1/20.9	30/33	30/35	27/30	111/111	32/35	35/35	29/32	113/113	---	---	---	---	---	---	---	---	---	---
		104B 105A	7.9/10.5 12.0/16.0	21.9/25.3 33.4/38.5	34/38 49/55	35/40 50/60	31/35 44/50	111/111 111/111	37/41 51/57	40/45 60/60	33/37 47/52	113/113 113/113	---	---	---	---	---	---	---	---	---	---
HIGH		NONE	---	---	---	23/23	30/30	23/23	147	25/25	30/30	25/25	149	---	---	---	---	---	---	---	---	---
		101A	3.3/4.4	9.2/10.6	23/24	30/30	23/23	147/147	25/26	30/30	25/25	149/149	---	---	---	---	---	---	---	---	---	---
		102A	4.9/6.5	13.6/15.6	28/30	30/30	25/27	147/147	30/33	30/35	27/30	149/149	---	---	---	---	---	---	---	---	---	---
		103B	6.5/8.7	18.1/20.9	34/37	35/40	30/34	147/147	36/39	40/40	33/36	149/149	---	---	---	---	---	---	---	---	---	---
		104B 105A	7.9/10.5 12.0/16.0	21.9/25.3 33.4/38.5	38/42 53/59	40/45 60/60	35/39 48/54	147/147 147/147	41/45 55/61	45/45 60/70	37/41 50/56	149/149 149/149	---	---	---	---	---	---	---	---	---	---

See "Legend and Notes for Table 41 on page 47."



ELECTRICAL INFORMATION

Table 41 – UNIT WIRE/FUSE OR HACR BREAKER SIZING DATA (cont)

UNIT	NO M. V.-Ph-HZ	ELEC. HTR				NO C.O. or UNPWR C.O.						w/ PWRD C.O.							
		IFM TYPE	CRHEATER***A00	Nom (kW)	FLA	NO PE.			w/ PE. (pwrdr fr/unit)			NO PE.			w/ PE. (pwrdr fr/unit)				
						MCA	MAX FUSE or HACR BRKR	DISC. SIZE FLA LRA	MCA	MAX FUSE or HACR BRKR	DISC. SIZE FLA LRA	MCA	MAX FUSE or HACR BRKR	DISC. SIZE FLA LRA	MCA	MAX FUSE or HACR BRKR	DISC. SIZE FLA LRA		
50KC-*04	DD-STD	NONE	-	-	-	12	15	13	15	13	44	14	20	14	45	15	20	16	46
		106A	6.0	7.2	13	15	14	20	14	44	17	20	15	45	18	20	17	46	
		107A	8.8	10.6	17	20	18	20	18	44	21	25	19	45	23	25	20	46	
		108A	11.5	13.8	20	25	22	24	25	44	25	23	23	45	27	30	24	46	
	MED	109A	14.0	16.8	24	30	24	43	25	44	28	30	26	45	30	30	28	46	
		NONE	-	-	10	15	10	57	11	58	13	15	13	59	14	15	14	60	
		106A	6.0	7.2	11	15	11	57	12	58	14	15	14	59	17	20	15	60	
		107A	8.8	10.6	15	20	15	57	16	58	18	20	18	59	21	25	19	60	
		108A	11.5	13.8	19	25	19	57	20	58	24	25	21	59	25	25	22	60	
		109A	14.0	16.8	22	25	22	57	23	58	27	30	25	59	29	30	26	60	
HIGH	NONE	-	-	12	15	12	75	13	76	15	20	15	77	16	20	16	78		
	106A	6.0	7.2	13	15	13	75	14	76	16	20	16	77	17	20	17	78		
	107A	8.8	10.6	17	20	17	75	18	76	20	20	18	77	23	25	21	78		
	108A	11.5	13.8	21	25	21	75	22	76	24	25	23	77	27	30	24	78		
575-3-60	109A	14.0	16.8	24	30	24	75	25	76	28	30	25	77	31	35	28	78		
	NONE	-	-	10	15	10	42	12	44	11	15	12	44	13	15	14	46		
	MED	-	-	7	15	7	45	9	47	9	15	9	47	11	15	11	49		
HIGH	NONE	-	-	8	15	8	60	10	62	10	15	10	62	12	15	12	64		

See "Legend and Notes for Table 41 on page 47.

ELECTRICAL INFORMATION

Table 41 – UNIT WIRE/FUSE OR HACR BREAKER SIZING DATA (cont)

UNIT	NO M. V.-Ph-HZ	ELEC. HTR				NO C.O. or UNPWR C.O.				w/ PWRD C.O.								
		CRHEATER***A00	Nom (kW)	FLA	MCA	MAX FUSE or HACR BRKR	FLA	LRA	MCA	MAX FUSE or HACR BRKR	FLA	LRA	MCA	MAX FUSE or HACR BRKR	FLA	LRA	MCA	
50KC-70S	DD-STD	NONE	-	-	37	50	35	128	39	50	37	130	-	-	-	-	-	-
		101A	3.9/4.4	15.9/18.3	37/37	37/37	50/50	35/35	128/128	39/39	50/50	37/37	130/130	-	-	-	-	-
		103B	6.5/6.7	31.4/36.3	49/55	49/55	50/60	45/50	128/128	51/57	60/60	47/52	130/130	-	-	-	-	-
		102A+102A	9.8/13.0	46.9/54.2	68/77	68/77	70/80	62/71	128/128	71/80	80/80	65/73	130/130	-	-	-	-	-
		103B+103B	13.1/17.4	62.8/72.5	88/100	88/100	90/100	81/92	128/128	91/103	100/110	83/94	130/130	-	-	-	-	-
		104B+104B	15.8/21.0	75.8/87.5	104/119	104/119	110/125	96/109	128/128	107/121	110/125	98/111	130/130	-	-	-	-	-
	MED	NONE	-	-	34	34	50	32	133	36	50	35	135	-	-	-	-	-
		101A	3.3/4.4	15.9/18.3	34/34	34/34	50/50	32/32	133/133	36/36	50/50	35/35	135/135	-	-	-	-	-
		103B	6.5/6.7	31.4/36.3	46/52	46/52	50/60	42/47	133/133	48/54	50/60	44/50	135/135	-	-	-	-	-
		102A+102A	9.8/13.0	46.9/54.2	65/74	65/74	70/80	60/68	133/133	68/77	70/80	62/70	135/135	-	-	-	-	-
		103B+103B	13.1/17.4	62.8/72.5	85/97	85/97	90/100	78/89	133/133	87/100	90/100	80/91	135/135	-	-	-	-	-
		104B+104B	15.8/21.0	75.8/87.5	101/116	101/116	110/125	93/106	133/133	104/118	110/125	95/108	135/135	-	-	-	-	-
HIGH	NONE	-	-	36	36	50	35	158	38	50	37	160	-	-	-	-	-	
	101A	3.3/4.4	15.9/18.3	36/36	36/36	50/50	35/35	158/158	38/38	50/50	37/37	160/160	-	-	-	-	-	
	103B	6.5/6.7	31.4/36.3	48/55	48/55	50/60	44/50	158/158	51/57	60/60	46/52	160/160	-	-	-	-	-	
	102A+102A	9.8/13.0	46.9/54.2	68/77	68/77	70/80	62/70	158/158	70/79	70/80	64/73	160/160	-	-	-	-	-	
	103B+103B	13.1/17.4	62.8/72.5	88/100	88/100	90/100	80/91	158/158	90/102	90/110	82/94	160/160	-	-	-	-	-	
	104B+104B	15.8/21.0	75.8/87.5	104/119	104/119	110/125	95/109	158/158	106/121	110/125	97/111	160/160	-	-	-	-	-	
DD-STD	NONE	-	-	26	26	30	26	94	28	40	28	96	31	40	32	99	33	
	102A	4.9/6.5	13.6/15.6	27/29	27/29	30/30	26/26	94/94	29/32	40/40	28/29	96/96	33/35	40/40	32/32	99/99	35/38	
	103B	6.5/6.7	18.1/20.9	32/36	32/36	35/40	29/33	94/94	35/38	40/40	32/35	96/96	38/42	40/45	35/38	99/99	41/44	
	105A	12.0/16.0	33.4/38.5	51/58	51/58	60/60	47/53	94/94	54/60	60/60	49/55	96/96	57/64	60/70	52/58	99/99	60/66	
	104B+104B	15.8/21.0	43.8/50.5	64/73	64/73	70/80	59/67	94/94	67/75	70/80	61/69	96/96	70/79	80/80	64/72	98/99	73/81	
	102A	4.9/6.5	13.6/15.6	24/24	24/24	30/30	23/23	123	26/26	30/30	26/25	125	29/29	40/40	29/29	128	31/31	
MED	102A	4.9/6.5	13.6/15.6	24/26	24/26	30/30	23/24	123/123	26/28	30/30	26/26	125/125	30/32	40/40	29/29	128/128	32/34	
	103B	6.5/6.7	18.1/20.9	30/33	30/33	30/35	27/30	123/123	32/35	35/35	29/32	125/125	36/39	40/40	32/35	128/128	38/41	
	105A	12.0/16.0	33.4/38.5	49/55	49/55	50/60	44/50	123/123	51/57	60/60	47/52	125/125	55/61	60/70	50/55	128/128	57/63	
	104B+104B	15.8/21.0	43.8/50.5	62/70	62/70	70/70	56/64	123/123	64/72	70/80	59/66	125/125	68/76	70/80	62/69	128/128	70/78	
	102A	4.9/6.5	13.6/15.6	27/27	27/27	40/40	27/27	159	29/29	40/40	29/29	161	32/32	45/45	33/33	164	34/34	
	103B	6.5/6.7	18.1/20.9	34/37	34/37	40/40	30/34	159/159	36/39	40/40	29/30	161/161	34/36	45/45	33/33	164/164	36/39	
HIGH	105A	12.0/16.0	33.4/38.5	53/59	53/59	60/60	48/54	159/159	55/61	60/70	50/56	161/161	59/65	60/70	54/59	164/164	61/67	
	104B+104B	15.8/21.0	43.8/50.5	68/74	68/74	70/80	60/68	159/159	68/76	70/80	62/70	161/161	72/80	80/80	66/73	164/164	74/82	
	102A	4.9/6.5	13.6/15.6	28/30	28/30	40/40	27/27	159/159	30/33	40/40	29/30	161/161	34/36	45/45	33/33	164/164	36/39	
	103B	6.5/6.7	18.1/20.9	34/37	34/37	40/40	30/34	159/159	36/39	40/40	29/30	161/161	40/43	45/45	36/39	164/164	42/45	

See "Legend and Notes for Table 41 on page 47.



ELECTRICAL INFORMATION

Table 41 – UNIT WIRE/FUSE OR HACR BREAKER SIZING DATA (cont)

UNIT	NO M, V-PH-HZ	ELEC. HTR			NO C.O. or UNPWR C.O.						w/ PWRD C.O.																	
		IFM TYPE	CRHEATER***A00	Nom (kW)	FLA	NO PE.			w/ RE. (pwrdr fr/unit)			NO PE.			w/ PWRD C.O.													
						MCA	MAX FUSE or HACR BRKR	FLA	DISC. SIZE	LRA	MCA	MAX FUSE or HACR BRKR	FLA	DISC. SIZE	LRA	MCA	MAX FUSE or HACR BRKR	FLA	DISC. SIZE	LRA								
50KC-*05	DD-STD	NONE	-	-	13	15	13	47	14	20	14	48	15	20	15	15	16	16	20	15	49	16	20	16	20	17	50	
		106A	6.0	7.2	13	15	13	47	16	20	14	48	17	20	15	14	18	17	20	15	49	18	20	17	20	17	50	
		108A	11.5	13.8	20	25	20	47	24	25	22	48	25	25	23	23	25	25	25	30	23	49	27	30	24	30	24	50
		109A	14.0	16.8	24	30	24	47	28	30	25	48	29	30	26	26	29	29	30	30	26	49	30	30	28	30	28	50
	108A+108A	23.0	27.7	36	40	36	47	41	45	38	48	43	45	39	39	44	44	44	45	39	49	44	45	40	45	40	50	
	MED	NONE	-	-	11	15	11	61	13	15	12	62	14	15	13	13	15	15	14	15	13	63	15	20	15	20	15	64
		106A	6.0	7.2	11	15	11	61	14	15	12	62	15	15	14	14	15	17	14	15	14	63	17	20	15	20	15	64
		108A	11.5	13.8	19	25	19	61	22	25	20	62	24	25	21	21	25	25	21	25	21	63	25	25	25	25	22	64
		109A	14.0	16.8	22	25	22	61	26	30	23	62	27	30	25	25	29	29	25	30	25	63	29	30	26	30	26	64
	108A+108A	23.0	27.7	35	40	35	61	39	40	36	62	41	45	37	37	42	42	41	45	37	63	42	45	38	45	38	64	
	HIGH	NONE	-	-	13	15	13	79	14	20	14	80	15	20	15	15	16	15	14	20	15	81	16	20	17	20	17	82
		106A	6.0	7.2	13	15	13	79	16	20	14	80	17	20	16	16	17	16	14	20	16	81	19	20	17	20	17	82
108A		11.5	13.8	21	25	21	79	24	25	22	80	26	30	23	23	27	24	25	30	23	81	27	30	24	30	24	82	
109A		14.0	16.8	24	30	24	79	28	30	25	80	29	30	27	27	31	28	29	30	27	81	31	35	28	35	28	82	
108A+108A	23.0	27.7	37	40	37	79	42	45	38	80	43	45	39	39	44	44	43	45	39	81	44	45	40	45	40	82		
DD-STD			11	15	11	39	13	15	13	41	13	15	13	13	15	15	13	15	13	41	15	20	15	20	15	43		
MED			8	15	8	42	11	15	10	44	10	15	10	15	10	12	10	15	10	44	12	15	15	12	15	46		
HIGH			9	15	9	57	12	15	12	59	12	15	11	15	11	13	12	15	11	59	13	15	15	14	15	61		

See "Legend and Notes for Table 41 on page 47."

ELECTRICAL INFORMATION

Table 41 – UNIT WIRE/FUSE OR HACR BREAKER SIZING DATA (cont)

UNIT	NO M. V - Ph - HZ	ELEC. HTR			NO C.O. or UNPWR C.O.				NO PE.				w/ PWRD C.O.						
		CRHEATER***A00	Nom (kW)	FLA	MCA	MAX FUSE or HACR BRKR	FLA	DISC. SIZE	MCA	MAX FUSE or HACR BRKR	FLA	DISC. SIZE	LRA	MCA	MAX FUSE or HACR BRKR	FLA	DISC. SIZE	LRA	
50KC - *06	DD - STD	NONE	-	-	41	60	39	144	42	60	41	146	-	-	-	-	-	-	-
		102A	4.9/6.5	23.5/27.1	41/44	60/60	39/40	144/144	42/46	60/60	41/42	146/146	-	-	-	-	-	-	-
		103B	6.5/8.7	31.4/36.3	49/55	60/60	45/50	144/144	51/57	60/60	47/52	146/146	-	-	-	-	-	-	-
		102A+102B	9.8/13.0	46.9/54.2	68/77	70/80	81/92	144/144	71/80	80/80	65/73	146/146	-	-	-	-	-	-	-
		103B+103B	13.1/17.4	62.8/72.5	88/100	90/100	91/103	144/144	91/103	100/110	83/94	146/146	-	-	-	-	-	-	-
	104B+104B	15.8/21.0	75.8/87.5	104/119	110/125	96/109	144/144	107/121	110/125	98/111	146/146	-	-	-	-	-	-	-	-
	MED	NONE	-	-	40	60	38	174	42	60	41	176	-	-	-	-	-	-	-
		102A	4.9/6.5	23.5/27.1	40/43	60/60	38/39	174/174	42/45	60/60	41/41	176/176	-	-	-	-	-	-	-
		103B	6.5/8.7	31.4/36.3	48/55	60/60	44/50	174/174	51/57	60/60	46/52	176/176	-	-	-	-	-	-	-
		102A+102A	9.8/13.0	46.9/54.2	68/77	70/80	62/70	174/174	70/79	70/80	64/73	176/176	-	-	-	-	-	-	-
103B+103B		13.1/17.4	62.8/72.5	88/100	90/100	80/91	174/174	90/102	90/110	82/94	176/176	-	-	-	-	-	-	-	
104B+104B	15.8/21.0	75.8/87.5	104/119	110/125	95/109	174/174	106/121	110/125	97/111	176/176	-	-	-	-	-	-	-	-	
208/230 - 1 - 60	DD - STD	NONE	-	-	29	40	28	120	31	45	122	-	-	-	-	-	-	-	
		102A	4.9/6.5	13.6/15.6	29/29	40/40	28/28	120/120	31/32	45/45	31/31	122/122	-	-	-	-	-	-	-
		104B	7.9/10.5	21.9/25.3	37/41	40/45	34/38	120/120	39/44	45/45	36/40	122/122	-	-	-	-	-	-	-
		105A	12.0/16.0	33.4/38.5	51/58	60/60	47/53	120/120	54/60	60/60	49/55	122/122	-	-	-	-	-	-	-
		104B+104B	15.8/21.0	43.8/50.5	64/73	70/80	59/67	120/120	67/75	70/80	61/69	122/122	-	-	-	-	-	-	-
	104B+105A	19.9/26.5	55.2/63.8	79/89	80/90	72/82	120/120	81/92	90/100	74/84	122/122	-	-	-	-	-	-	-	-
	MED	NONE	-	-	30/30	45/45	30/29	185	32/32	45/45	32/32	187	-	-	-	-	-	-	-
		102A	4.9/6.5	13.6/15.6	30/30	45/45	30/29	185/185	32/33	45/45	32/32	187/187	-	-	-	-	-	-	-
		104B	7.9/10.5	21.9/25.3	38/42	45/45	35/39	185/185	41/45	45/45	37/41	187/187	-	-	-	-	-	-	-
		105A	12.0/16.0	33.4/38.5	53/59	60/60	48/54	185/185	55/61	60/70	50/56	187/187	-	-	-	-	-	-	-
104B+104B		15.8/21.0	43.8/50.5	66/74	70/80	60/68	185/185	68/76	70/80	62/70	187/187	-	-	-	-	-	-	-	
104B+105A	19.9/26.5	55.2/63.8	80/91	80/100	73/83	185/185	82/93	90/100	75/85	187/187	-	-	-	-	-	-	-	-	
208/230 - 3 - 60	HIGH	NONE	-	-	30/30	45/45	30/29	185	32/32	45/45	187	-	-	-	-	-	-	-	
		102A	4.9/6.5	13.6/15.6	30/30	45/45	30/29	185/185	32/33	45/45	32/32	187/187	-	-	-	-	-	-	-
		104B	7.9/10.5	21.9/25.3	38/42	45/45	35/39	185/185	41/45	45/45	37/41	187/187	-	-	-	-	-	-	-
		105A	12.0/16.0	33.4/38.5	53/59	60/60	48/54	185/185	55/61	60/70	50/56	187/187	-	-	-	-	-	-	-
		104B+104B	15.8/21.0	43.8/50.5	66/74	70/80	60/68	185/185	68/76	70/80	62/70	187/187	-	-	-	-	-	-	-
104B+105A	19.9/26.5	55.2/63.8	80/91	80/100	73/83	185/185	82/93	90/100	75/85	187/187	-	-	-	-	-	-	-	-	

See "Legend and Notes for Table 41 on page 47.



50KC

ELECTRICAL INFORMATION

Table 41 – UNIT WIRE/FUSE OR HACR BREAKER SIZING DATA (cont)

UNIT	NO M, V, Ph-HZ	IFM TYPE	ELEC. HTR			NO C.O. or UNPWR C.O.						w/ PWRD C.O.											
			CRHEATER***A00	Nom (kW)	FLA	NO PE.			w/ RE. (pwrd fr/unit)			NO PE.			w/ RE. (pwrd fr/unit)								
						MCA	MAX FUSE or HACR BRKR	DISC. SIZE	FLA	LRA	MCA	MAX FUSE or HACR BRKR	DISC. SIZE	FLA	LRA	MCA	MAX FUSE or HACR BRKR	DISC. SIZE	FLA	LRA			
50KC-06	460-3-60	DD-STD	NONE	-	-	14	20	14	58	15	20	15	59	16	20	16	60	17	20	17	61		
			106A	6.0	7.2	14	20	14	58	16	20	15	59	17	20	16	60	18	20	17	61		
			108A	11.5	13.8	20	25	20	58	24	25	22	59	25	23	25	23	60	27	30	24	61	
			109A	14.0	16.8	24	30	24	58	28	30	25	59	29	26	30	26	60	30	30	28	61	
			108A+108A	23.0	27.7	36	40	36	58	41	45	38	59	43	39	45	39	60	44	45	40	61	
			108A+109A	25.5	30.7	40	45	40	58	45	45	41	59	47	42	50	42	60	48	50	44	61	
			NONE	-	-	14	20	14	90	15	20	15	20	15	91	17	20	16	92	18	20	18	93
			106A	6.0	7.2	14	20	14	90	16	20	15	20	15	91	17	20	16	92	19	20	18	93
			108A	11.5	13.8	21	25	21	90	24	25	22	25	22	91	26	30	23	92	27	30	24	93
			109A	14.0	16.8	24	30	24	90	28	30	25	30	25	91	29	30	27	92	31	35	28	93
50KC-06	460-3-60	HIGH	108A+108A	23.0	27.7	37	40	40	90	42	45	38	91	43	45	39	92	44	45	40	93		
			108A+109A	25.5	30.7	40	45	40	90	45	45	41	91	47	50	43	92	48	50	44	93		
			NONE	-	-	14	20	14	90	15	20	15	91	17	20	16	92	18	20	18	93		
			106A	6.0	7.2	14	20	14	90	16	20	15	91	17	20	16	92	19	20	18	93		
575-3-60	575-3-60	DD-STD	NONE	-	-	12	15	12	46	14	15	48	13	15	13	48	15	20	16	50			
			NONE	-	-	10	15	10	64	12	15	12	66	12	15	12	66	14	15	14	68		
			NONE	-	-	10	15	10	64	12	15	12	66	12	15	12	66	14	15	14	68		

See "Legend and Notes for Table 41 on page 47.

Legend and Notes for Table 41

LEGEND:

BRKR	–	Circuit breaker
CO	–	Convenient outlet
DD	–	Direct drive (indoor fan motor)
DISC	–	Disconnect
FLA	–	Full load amps
IFM	–	Indoor fan motor
LRA	–	Locked rotor amps
MCA	–	Minimum circuit amps
MOCP	–	MAX FUSE or HACR Breaker
PE	–	Power exhaust
PWRD CO	–	Powered convenient outlet
UNPWR CO	–	Unpowered convenient outlet

NOTES:

- In compliance with NEC requirements for multimotor and combination load equipment (refer to NEC Articles 430 and 440), the overcurrent protective device for the unit shall be fuse or HACR breaker. Canadian units may be fuse or circuit breaker.
- Unbalanced 3-Phase Supply Voltage**
Never operate a motor where a phase imbalance in supply voltage is greater than 2%. Use the following formula to determine the percentage of voltage imbalance.

$$\% \text{ Voltage Imbalance} = 100 \times \frac{\text{max voltage deviation from average voltage}}{\text{average voltage}}$$

Example: Supply voltage is 230-3-60



AB = 224 v
BC = 231 v
AC = 226 v

$$\begin{aligned} \text{Average Voltage} &= \frac{(224 + 231 + 226)}{3} = \frac{681}{3} \\ &= 227 \end{aligned}$$

Determine maximum deviation from average voltage.

(AB) 227 – 224 = 3 v

(BC) 231 – 227 = 4 v

(AC) 227 – 226 = 1 v

Maximum deviation is 4 v.

Determine percent of voltage imbalance.

$$\begin{aligned} \% \text{ Voltage Imbalance} &= 100 \times \frac{4}{227} \\ &= 1.76\% \end{aligned}$$

This amount of phase imbalance is satisfactory as it is below the maximum allowable 2%.

IMPORTANT: If the supply voltage phase imbalance is more than 2%, contact your local electric utility company immediately.

50KC

SEQUENCE OF OPERATION

General

The sequence below describes the sequence of operation for an electromechanical unit with and without a factory installed EconoMiSer™ IV and X (called “economizer” in this sequence). For information regarding a direct digital controller, see the start-up, operations, and troubleshooting manual for the applicable controller.

Electromechanical units with no economizer

Cooling (Single speed indoor fan motor) —

When the thermostat calls for cooling, terminals G and Y1 are energized. As a result, the indoor fan contactor (IFC) and the compressor contactor (C1) are energized, causing the indoor fan motor (IFM), compressor #1, and outdoor fan to start. If the unit has 2 stages of cooling, the thermostat will additionally energize Y2. The Y2 signal will energize compressor contactor #2 (C2), causing compressor #2 to start. Regardless of the number of stages, the outdoor fan motor runs continuously while unit is cooling.

Heating

NOTE: The 50KC is sold as cooling only. If electric heaters are required, use only factory-approved electric heaters. They will operate as described below.

Units have either 1 or 2 stages of electric heat. When the thermostat calls for heating, power is applied to the W1 terminal at the unit. The unit control will energize the indoor fan contactor and the first stage of electric heat. On units with 2-stage heating, when additional heating is required, the second stage of electric heat (if equipped) will be energized when power is applied at the W2 terminal on the unit.

Electromechanical units with an economizer

Cooling —

When free cooling is not available, the compressors will be controlled by the zone thermostat. When free cooling is available, the outdoor air damper is modulated by the EconoMiSer IV and X control to provide a 50°F (10°C) to 55°F (13°C) mixed air temperature into the zone. As the mixed air temperature fluctuates above 55°F (13°C) or below 50°F (10°C) dampers will be modulated (open or close) to bring the mixed air temperature back within control. If mechanical cooling is utilized with free cooling, the outdoor air damper will maintain its current position at the time the compressor is started. If the increase in cooling capacity causes the mixed air temperature to drop below 45°F (9°C), then the outdoor air damper position will be decreased to the minimum position. If the mixed air temperature continues to fall, the outdoor air damper will close. Control returns to normal once the mixed air temperature rises above 48°F (9°C). The power exhaust fans will be energized and de-energized, if installed, as the outdoor air damper opens and closes.

If field-installed accessory CO₂ sensors are connected to the EconoMiSer IV and X control, a demand controlled ventilation strategy will begin to operate. As the CO₂ level in the zone increases above the CO₂ setpoint, the minimum position of the damper will be increased proportionally. As the CO₂ level decreases because of the increase in fresh air, the outdoor air damper will be proportionally closed. For EconoMiSer IV and X operation, there must be a thermostat call for the fan (G). If the unit is occupied and the fan is on, the damper will operate at minimum position. Otherwise, the damper will be closed.

SEQUENCE OF OPERATION (cont.)

When the EconoMi\$er IV and X control is in the occupied mode and a call for cooling exists (Y1 on the thermostat), the control will first check for indoor fan operation. If the fan is not on, then cooling will not be activated. If the fan is on, then the control will open the EconoMi\$er IV and X damper to the minimum position.

On the initial power to the EconoMi\$er IV and X control, it will take the damper up to 2 1/2 minutes before it begins to position itself. After the initial power-up, further changes in damper position can take up to 30 seconds to initiate. Damper movement from full closed to full open (or vice versa) will take between 1 1/2 and 2 1/2 minutes. If free cooling can be used as determined from the appropriate changeover command (switch, dry bulb, enthalpy curve, differential dry bulb, or differential enthalpy), then the control will modulate the dampers open to maintain the mixed air temperature setpoint at 50°F (10°C) to 55°F (13°C). If there is a further demand for cooling (cooling second stage - Y2 is energized), then the control will bring on compressor stage 1 to maintain the mixed air temperature setpoint. The EconoMi\$er IV and X damper will be open at maximum position. EconoMi\$er IV and X operation is limited to a single compressor.

Heating

The sequence of operation for the heating is the same as an electromechanical unit with no economizer. The only difference is how the economizer acts. The economizer will stay at the Economizer Minimum Position while the evaporator fan is operating. The outdoor air damper is closed when the indoor fan is not operating.

Optional Humidi-MiZer Dehumidification System

Units with the factory equipped Humidi-MiZer option are capable of providing multiple modes of improved dehumidification as a variation of the normal cooling cycle. The Humidi-MiZer option includes additional valves in the liquid line and discharge line of each refrigerant circuit, a small reheat condenser coil downstream of the evaporator, and Motormaster variable-speed control of some or all outdoor fans. Operation of the revised refrigerant circuit for each mode is described below.

The Humidi-MiZer system provides three sub-modes of operation: Cool, Reheat1, and Reheat2.

Cool mode - provides a normal ratio of Sensible and Latent Cooling effect from the evaporator coil.

Reheat1 - provides increased Latent Cooling while slightly reducing the Sensible Cooling effect.

Reheat2 - provides normal Latent Cooling but with null or minimum Sensible Cooling effect delivered to the space.

The Reheat1 and Reheat2 modes are available when the unit is not in a Heating mode and when the Low Ambient Lockout switch is closed.

The following diagrams depict piping for Single Stage cooling units.

SEQUENCE OF OPERATION (cont.)

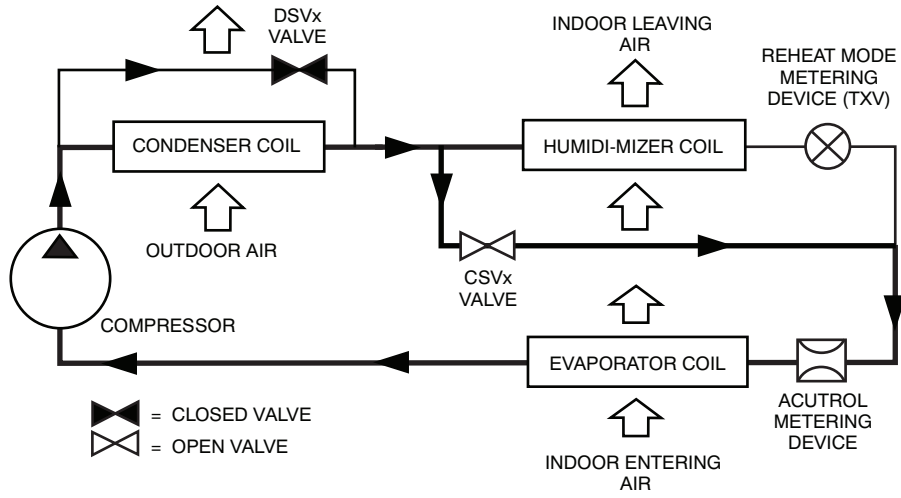

Fig. 5 - Normal Cooling Mode - Humidi-MiZer System with Single Stage Cooling

C12647

50KC

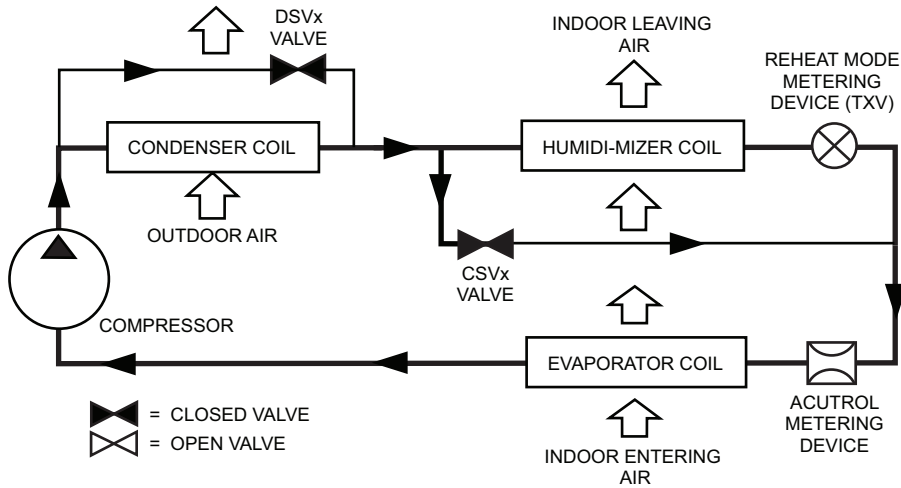

Fig. 6 - Subcooling Mode (Reheat 1) - Humidi-MiZer System with Single Stage Cooling

C12648

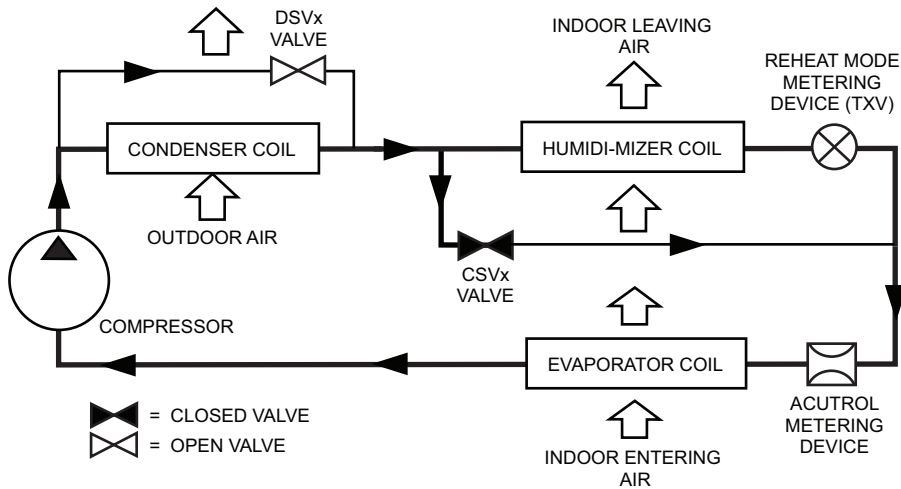

Fig. 7 - Hot Gas Reheat Mode (Reheat 2) - Humidi-MiZer System with Single Stage Cooling

C12649

**Cooling Only/Electric Heat Packaged Rooftop
HVAC Guide Specifications**

Size Range: 3 to 5 Nominal Tons



50KC

Section Description

23 06 80 Schedules for Decentralized HVAC Equipment

- 23 06 80.13 Decentralized Unitary HVAC Equipment Schedule
- 23 06 80.13.A. Rooftop unit schedule
 1. Schedule is per the project specification requirements.

23 07 16 HVAC Equipment Insulation

- 23 07 16.13 Decentralized, Rooftop Units:
- 23 07 16.13.A. Evaporator fan compartment:
 1. Interior cabinet surfaces shall be insulated with a minimum 1/2-in. thick, minimum 1 1/2 lb density, flexible fiberglass insulation bonded with a phenolic binder, neoprene coated on the air side.
 2. Insulation and adhesive shall meet NFPA 90A requirements for flame spread and smoke generation.
- 23 07 16.13.B. Electric heat compartment:
 1. Aluminum foil-faced fiberglass insulation shall be used.
 2. Insulation and adhesive shall meet NFPA 90A requirements for flame spread and smoke generation.

23 09 13 Instrumentation and Control Devices for HVAC

- 23 09 13.23 Sensors and Transmitters
- 23 09 13.23.A. Thermostats
 1. Thermostat must
 - a. energize both “W” and “G” when calling for heat.
 - b. have capability to energize 1 stage of cooling, and 2 different stages of heating.
 - c. include capability for occupancy scheduling.

23 09 23 Direct-digital Control system for HVAC

- 23 09 23.13 Decentralized, Rooftop Units:
- 23 09 23.13.A. PremierLink controller
 1. Shall be ASHRAE 62 compliant.
 2. Shall accept 18-32VAC input power.
 3. Shall have an operating temperature range from -40°F (-40°C) to 158°F (70°C), 10% - 95% RH (non-condensing).
 4. Shall include an integrated economizer controller to support an economizer with 4 to 20 mA actuator input and no microprocessor controller.
 5. Controller shall accept the following inputs: space temperature, setpoint adjustment, outdoor air temperature, indoor air quality, outdoor air quality, indoor relative humidity, compressor lock-out, fire shutdown, enthalpy, fan status, remote time clock/door switch.
 6. Shall accept a CO₂ sensor in the conditioned space, and be Demand Control Ventilation (DCV) ready.
 7. Shall provide the following outputs: Economizer, fan, cooling stage 1, cooling stage 2, heat stage 1, heat stage 2, heat stage 3/ exhaust/ reversing valve/ dehumidify/ occupied.
 8. Unit shall provide surge protection for the controller through a circuit breaker.
 9. Shall be Internet capable, and communicate at a Baud rate of 38.4K or faster
 10. Shall have an LED display independently showing the status of activity on the communication bus, and processor operation.
 11. Shall include an RS-485 protocol communication port, an access port for connection of either a computer or a Carrier technician tool, an RS-485 port for network communication to intelligent space sensors and displays, and a port to connect an optional LonWorks plug-in communications card.
 12. Shall have built-in Carrier Comfort Network (CCN) protocol, and be compatible with other CCN devices, including ComfortLink and ComfortVIEW controllers.
 13. Shall have built-in support for Carrier technician tool.

- 14. Software upgrades will be accomplished by local download. Software upgrades through chip replacements are not allowed.
 - 15. Shall be shock resistant in all planes to 5G peak, 11ms during operation, and 100G peak, 11ms during storage.
 - 16. Shall be vibration resistant in all planes to 1.5G @ 20-300 Hz.
 - 17. Shall support a bus length of 4000 ft max, 60 devices per 1000 ft section, and 1 RS-485 repeater per 1000 ft sections.
- 23 09 23.13.B. RTU Open - Open protocol, direct digital controller:
- 1. Shall be ASHRAE 62 compliant.
 - 2. Shall accept 18-30VAC, 50-60Hz, and consumer 15VA or less power.
 - 3. Shall have an operating temperature range from -40°F (-40°C) to 130°F (54°C), 10% - 90% RH (non-condensing).
 - 4. Shall include built-in protocol for BACNET (MS/TP and PTP modes), Modbus (RTU and ASCII), Johnson N2 and LonWorks. LonWorks Echelon processor required for all Lon applications shall be contained in separate communication board.
 - 5. Shall allow access of up to 62 network variables (SNVT). Shall be compatible with all open controllers
 - 6. Baud rate Controller shall be selectable using a dipswitch.
 - 7. Shall have an LED display independently showing the status of serial communication, running, errors, power, all digital outputs, and all analog inputs.
 - 8. Shall accept the following inputs: space temperature, setpoint adjustment, outdoor air temperature, indoor air quality, outdoor air quality, compressor lock-out, fire shutdown, enthalpy switch, and fan status/filter status/ humidity/ remote occupancy.
 - 9. Shall provide the following outputs: economizer, fan, cooling stage 1, cooling stage 2, heat stage 1, heat stage 2, heat stage 3/ exhaust/ reversing valve.
 - 10. Shall have built-in surge protection circuitry through solid state polyswitches. Polyswitches shall be used on incoming power and network connections. Polyswitches will return to normal when the “trip” condition clears.
 - 11. Shall have a battery backup capable of a minimum of 10,000 hours of data and time clock retention during power outages.
 - 12. Shall have built-in support for Carrier technician tool.
 - 13. Shall include an RS-485 protocol communication port, an access port for connection of either a computer or a Carrier technician tool, an RS-485 port for network communication to intelligent space sensors and displays, and a port to connect an optional LonWorks communications card.
 - 14. Software upgrades will be accomplished by either local or remote download. No software upgrades through chip replacements are allowed.

23 09 33 Electric and Electronic Control System for HVAC

23 09 33.13 Decentralized, Rooftop Units:

23 09 33.13.A. General:

- 1. Shall be complete with self-contained low-voltage control circuit protected by a resettable circuit breaker on the 24-v transformer side. Transformer shall have 75VA capability.
- 2. Shall utilize color-coded wiring.
- 3. Shall include a central control terminal board to conveniently and safely provide connection points for vital control functions such as: smoke detectors, phase monitor, economizer, thermostat, DDC control options, and low and high pressure switches.
- 4. Unit shall include a minimum of one 8-pin screw terminal connection board for connection of control wiring.

23 09 33.23.B. Safeties:

- 1. Compressor over-temperature, over current.
- 2. Low pressure switch.
 - a. Low pressure switch shall use different color wire than the high pressure switch. The purpose is to assist the installer and service technician to correctly wire and or troubleshoot the rooftop unit.
- 3. High pressure switch.
 - a. High pressure switch shall use different color wire than the low pressure switch. The purpose is to assist the installer and service technician to correctly wire and or troubleshoot the rooftop unit.
- 4. Automatic reset, motor thermal overload protector.

23 09 93 Sequence of Operations for HVAC Controls

23 09 93.13 Decentralized, Rooftop Units:

23 09 93.13 INSERT SEQUENCE OF OPERATION

23 40 13 Panel Air Filters

23 40 13.13 Decentralized, Rooftop Units:

23 40 13.13.A. Standard filter section

1. Shall consist of factory-installed, low velocity, throwaway 2-in. thick fiberglass filters of commercially available sizes.
2. Unit shall use only one filter size. Multiple sizes are not acceptable.
3. Filters shall be accessible through an access panel with “no-tool” removal as described in the unit cabinet section of this specification (23 81 19.13.G).

23 81 19 Self-Contained Air Conditioners

23 81 19.13 Small-Capacity Self-Contained Air Conditioners (50KC**04-06)

23 81 19.13.A. General

1. Outdoor, rooftop mounted, electrically controlled, heating and cooling unit utilizing a(n) hermetic scroll compressor(s) for cooling duty and gas combustion for heating duty.
2. Factory assembled, single-piece heating and cooling rooftop unit. Contained within the unit enclosure shall be all factory wiring, piping, controls, and special features required prior to field start-up.
3. Unit shall use Puron refrigerant.
4. Unit shall be installed in accordance with the manufacturer’s instructions.
5. Unit must be selected and installed in compliance with local, state, and federal codes.

23 81 19.13.B. Quality Assurance

1. Unit meets ASHRAE 90.1 minimum efficiency requirements.
2. Unit shall be rated in accordance with AHRI Standards 210/240.
3. Unit shall be designed to conform to ASHRAE 15.
4. Unit shall be UL-tested and certified in accordance with ANSI Z21.47 Standards and UL-listed and certified under Canadian standards as a total package for safety requirements.
5. Insulation and adhesive shall meet NFPA 90A requirements for flame spread and smoke generation.
6. Unit casing shall be capable of withstanding 500-hour salt spray exposure per ASTM B117 (scribed specimen).
7. Unit shall be designed in accordance with ISO 9001:2000, and shall be manufactured in a facility registered by ISO 9001:2000.
8. Roof curb shall be designed to conform to NRCA Standards.
9. Unit shall be subjected to a completely automated run test on the assembly line. The data for each unit will be stored at the factory, and must be available upon request.
10. Unit shall be designed in accordance with UL Standard 1995, including tested to withstand rain.
11. Unit shall be constructed to prevent intrusion of snow and tested to prevent snow intrusion into the control box up to 40 mph.
12. Unit shake tested to assurance level 1, ASTM D4169 to ensure shipping reliability.

23 81 19.13.C. Delivery, Storage, and Handling

1. Unit shall be stored and handled per manufacturer’s recommendations.
2. Lifted by crane requires either shipping top panel or spreader bars.
3. Unit shall only be stored or positioned in the upright position.

23 81 19.13.D. Project Conditions

1. As specified in the contract.

23 81 19.13.E. Operating Characteristics

1. Unit shall be capable of starting and running at 115°F (46°C) ambient outdoor temperature, meeting maximum load criteria of AHRI Standard 210/240 at ± 10% voltage.
2. Compressor with standard controls shall be capable of operation down to 40°F (4°C), ambient outdoor temperatures. Accessory winter start kit is necessary if mechanically cooling at ambient temperatures down to 25°F (-4°C).
3. Unit shall discharge supply air vertically or horizontally as shown on contract drawings.
4. Unit shall be factory configured for vertical supply & return configurations.
5. Unit shall be field convertible from vertical to horizontal airflow on all models. No special kit required.
6. Unit shall be capable of mixed operation: vertical supply with horizontal return or horizontal supply with vertical return.

23 81 19.13.F. Electrical Requirements

1. Main power supply voltage, phase, and frequency must match those required by the manufacturer.

23 81 19.13.G. Unit Cabinet

1. Unit cabinet shall be constructed of galvanized steel, and shall be bonderized and coated with a pre-painted baked enamel finish on all externally exposed surfaces.
2. Unit cabinet exterior paint shall be: film thickness, (dry) 0.003 inches minimum, gloss (per ASTM D523, 60°F): 60, Hardness: H-2H Pencil hardness.
3. Evaporator fan compartment interior cabinet insulation shall conform to AHRI Standards 210/240 minimum exterior sweat criteria. Interior surfaces shall be insulated with a minimum 1/2-in. thick, 1 lb density, flexible fiberglass insulation, neoprene coated on the air side. Aluminum foil-faced fiberglass insulation shall be used in the heat compartment.
4. Base of unit shall have a minimum of four locations for thru-the-base gas and electrical connections (factory installed or field installed), standard.
5. Base Rail
 - a. Unit shall have base rails on a minimum of 2 sides.
 - b. Holes shall be provided in the base rails for rigging shackles to facilitate maneuvering and overhead rigging.
 - c. Holes shall be provided in the base rail for moving the rooftop by fork truck.
 - d. Base rail shall be a minimum of 16 gauge thickness.
6. Condensate pan and connections:
 - a. Shall be a sloped condensate drain pan made of a non-corrosive material.
 - b. Shall comply with ASHRAE Standard 62.
 - c. Shall use a 3/4" -14 NPT drain connection, possible either through the bottom or end of the drain pan. Connection shall be made per manufacturer's recommendations.
7. Top panel:
 - a. Shall be a single piece top panel on all sizes.
8. Electrical Connections
 - a. All unit power wiring shall enter unit cabinet at a single, factory-prepared, knockout location.
 - b. Thru-the-base capability
 - (1.) Standard unit shall have a thru-the-base electrical location(s) using a raised, embossed portion of the unit basepan.
 - (2.) Optional, factory-approved, water-tight connection method must be used for thru-the-base electrical connections.
 - (3.) No basepan penetration, other than those authorized by the manufacturer, is permitted.
9. Component access panels (standard)
 - a. Cabinet panels shall be easily removable for servicing.
 - b. Unit shall have one factory installed, tool-less, removable, filter access panel.
 - c. Panels covering control box, indoor fan, indoor fan motor, gas components (where applicable), and compressors shall have molded composite handles.
 - d. Handles shall be UV modified, composite. permanently attached, and recessed into the panel.
 - e. Screws on the vertical portion of all removable access panel shall engage into heat resistant, molded composite collars.
 - f. Collars shall be removable and easily replaceable using manufacturer recommended parts.

23 81 19.13.I. Coils

1. Standard Aluminum fin - Copper Tube Coils:
 - a. Standard evaporator and condenser coils shall have aluminum lanced plate fins mechanically bonded to seamless internally grooved copper tubes with all joints brazed.
 - b. Evaporator coils shall be leak tested to 150 psig, pressure tested to 450 psig, and qualified to UL 1995 burst test at 1775 psig.
 - c. Condenser coils shall be leak tested to 150 psig, pressure tested to 650 psig, and qualified to UL 1995 burst test at 1980 psig.
2. Optional Pre-coated aluminum-fin condenser coils (3 Phase Models Only):
 - a. Shall have a durable epoxy-phenolic coating to provide protection in mildly corrosive coastal environments.
 - b. Coating shall be applied to the aluminum fin stock prior to the fin stamping process to create an inert barrier between the aluminum fin and copper tube.
 - c. Epoxy-phenolic barrier shall minimize galvanic action between dissimilar metals.
3. Optional Copper-fin evaporator and condenser coils (3 Phase Models Only):
 - a. Shall be constructed of copper fins mechanically bonded to copper tubes and copper tube sheets.
 - b. Galvanized steel tube sheets shall not be acceptable.

- c. A polymer strip shall prevent coil assembly from contacting the sheet metal coil pan to minimize potential for galvanic corrosion between coil and pan.
- 4. Optional E-coated aluminum-fin evaporator and condenser coils (3 Phase Models Only):
 - a. Shall have a flexible epoxy polymer coating uniformly applied to all coil surface areas without material bridging between fins.
 - b. Coating process shall ensure complete coil encapsulation of tubes, fins and headers.
 - c. Color shall be high gloss black with gloss per ASTM D523-89.
 - d. Uniform dry film thickness from 0.8 to 1.2 mil on all surface areas including fin edges.
 - e. Superior hardness characteristics of 2H per ASTM D3363-92A and cross-hatch adhesion of 4B-5B per ASTM D3359-93.
 - f. Impact resistance shall be up to 160 in.-lb (ASTM D2794-93).
 - g. Humidity and water immersion resistance shall be up to minimum 1000 and 250 hours respectively (ASTM D2247-92 and ASTM D870-92).
 - h. Corrosion durability shall be confirmed through testing to be no less than 1000 hours salt spray per ASTM B117-90.

5. Standard All Aluminum Novation Coils:

23 81 19.13.J. Refrigerant Components

- 1. Refrigerant circuit shall include the following control, safety, and maintenance features:
 - a. Fixed orifice metering system shall prevent mal-distribution of two-phase refrigerant by including multiple fixed orifice devices in each refrigeration circuit. Each orifice is to be optimized to the coil circuit it serves.
 - b. Refrigerant filter drier.
 - c. Service gauge connections on suction and discharge lines.
 - d. Pressure gauge access through a specially designed access port in the top panel of the unit.
- 2. There shall be gauge line access port in the skin of the rooftop, covered by a black, removable plug.
 - a. The plug shall be easy to remove and replace.
 - b. When the plug is removed, the gauge access port shall enable maintenance personnel to route their pressure gauge lines.
 - c. This gauge access port shall facilitate correct and accurate condenser pressure readings by enabling the reading with the compressor access panel on.
 - d. The plug shall be made of a leak proof, UV-resistant, composite material.
- 3. Compressors
 - a. Unit shall use one fully hermetic, scroll compressor for each independent refrigeration circuit.
 - b. Compressor motors shall be cooled by refrigerant gas passing through motor windings.
 - c. Compressors shall be internally protected from high discharge temperature conditions.
 - d. Compressors shall be protected from an over-temperature and over-ampereage conditions by an internal, motor overload device.
 - e. Compressor shall be factory mounted on rubber grommets.
 - f. Compressor motors shall have internal line break thermal, current overload and high pressure differential protection.
 - g. Crankcase heaters shall not be required for normal operating range, unless provided by compressor manufacturer due to refrigerant charge limits.

23 81 19.13.K. Filter Section

- 1. Filters access is specified in the unit cabinet section of this specification.
- 2. Filters shall be held in place by a pivoting filter tray, facilitating easy removal and installation.
- 3. Shall consist of factory-installed, low velocity, throw-away 2-in. thick fiberglass filters.
- 4. Filters shall be standard, commercially available sizes.
- 5. Only one size filter per unit is allowed.

23 81 19.13.L. Evaporator Fan and Motor

- 1. Evaporator fan motor:
 - a. Shall have permanently lubricated bearings.
 - b. Shall have inherent automatic-reset thermal overload protection or circuit breaker.
 - c. Shall have a maximum continuous bhp rating for continuous duty operation; no safety factors above that rating shall be required.
- 2. Direct Drive ECM X13 - Evaporator Fan Standard:
 - a. Multi-speed motor with easy quick adjustment settings.

- b. Blower fan shall be double-inlet type with forward-curved blades.
 - c. Shall be constructed from steel with a corrosion resistant finish and dynamically balanced.
3. Belt-driven Evaporator Fan Optional:
- a. Belt drive shall include an adjustable pitch motor pulley.
 - b. Shall use sealed, permanently lubricated ball-bearing type.
 - c. Blower fan shall be double-inlet type with forward-curved blades.
 - d. Shall be constructed from steel with a corrosion resistant finish and dynamically balanced.

23 81 19.13.M. Condenser Fans and Motors

- 1. Condenser fan motors:
 - a. Shall be a totally enclosed motor.
 - b. Shall use permanently lubricated bearings.
 - c. Shall have inherent thermal overload protection with an automatic reset feature.
 - d. Shall use a shaft-down design on all sizes.
- 2. Condenser Fans:
 - a. Shall be a direct-driven propeller type fan.
 - b. Shall have galvalum blades riveted to corrosion-resistant steel spiders and shall be dynamically balanced.

23 81 19.13.N. Special Features, Options and Accessories

- 1. Integrated EconoMiSer IV, EconoMiSer2, and EconoMiSer X standard leak rate models. (Factory installed on 3 phase models only. Field installed on all 3 and 1 phase models)
 - a. Integrated, gear driven opposing modulating blade design type capable of simultaneous economizer and compressor operation.
 - b. Independent modules for vertical or horizontal return configuration shall be available. Vertical return modules shall be available as a factory installed option.
 - c. Damper blades shall be galvanized steel with composite gears. Plastic or composite blades on intake or return shall not be acceptable.
 - d. Shall include all hardware and controls to provide free cooling with outdoor air when temperature and/or humidity are below setpoints.
 - e. Shall be equipped with gear driven dampers for both the outdoor ventilation air and the return air for positive air stream control.
 - f. Standard leak rate shall be equipped with dampers not to exceed 2% leakage at 1 in. wg pressure differential.
 - g. Economizer controller on EconoMiSer IV models shall be Honeywell W7212 that provides:
 - (1.) Combined minimum and DCV maximum damper position potentiometers with compressor staging relay.
 - (2.) Functions with solid state analog enthalpy or dry bulb changeover control sensing.
 - (3.) Contain LED indicates for:
 - when free cooling is available, when module is in DCV mode, when exhaust fan contact is closed.
 - h. Economizer controller on EconoMiSer X models shall be the Honeywell W7220 that provides:
 - (1.) 2-line LCD interface screen for setup, configuration and troubleshooting.
 - (2.) On-board Fault Detection and Diagnostics (FDD) that senses and alerts when the economizer is not operating properly, per California Title 24.
 - (3.) Sensor failure loss of communication identification
 - (4.) Automatic sensor detection
 - (5.) Capabilities for use with multiple-speed indoor fan systems
 - (6.) Utilize digital sensors: Dry bulb and Enthalpy
 - i. Economizer controller on EconoMiSer 2 models with PremierLink shall be 4-20mA design and controlled by the PremierLink controller. PremierLink does not comply with California Title 24 Fault Detection & Diagnostic (FDD) requirements.
 - j. Economizer controller on EconoMiSer 2 models with RTU Open models shall be a 4-20mA design controlled directly by the RTU Open controller. RTU Open meets California Title 24 Fault Detection & Diagnostic (FDD) requirements.
 - k. Shall be capable of introducing up to 100% outdoor air.
 - l. Shall be equipped with a barometric relief damper capable of relieving up to 100% return air and contain seals that meet ASHRAE 90.1 requirements.
 - m. Shall be designed to close damper(s) during loss-of-power situations with spring return built into motor.

- n. Dry bulb outdoor air temperature sensor shall be provided as standard. Enthalpy sensor is also available on factory installed only. Outdoor air sensor setpoint shall be adjustable and shall range from 40 to 100°F /4 to 38°C. Additional sensor options shall be available as accessories.
 - o. The economizer controller shall also provide control of an accessory power exhaust unit function. Factory set at 100%, with a range of 0% to 100%.
 - p. The economizer shall maintain minimum airflow into the building during occupied period and provide design ventilation rate for full occupancy.
 - q. Dampers shall be completely closed when the unit is in the unoccupied mode.
 - r. Economizer controller shall accept a 2-10 Vdc CO₂ sensor input for IAQ/DCV control. In this mode, dampers shall modulate the outdoor air damper to provide ventilation based on the sensor input.
 - s. Compressor lockout temperature on W7220 is adjustable from -45°F to 80°F, set at a factory default of 32°F. Others shall open at 35°F (2°C) and closes at 50°F (10°C).
 - t. Actuator shall be direct coupled to economizer gear. No linkage arms or control rods shall be acceptable.
 - u. Economizer controller shall provide indications when in free cooling mode, in the DCV mode, or the exhaust fan contact is closed.
2. Integrated EconoMi\$er2, and EconoMi\$er X Ultra Low Leak rate models.(Factory installed on 3 phase models only. Field installed on all 3 and 1 phase models)
- a. Integrated, gear driven opposing modulating blade design type capable of simultaneous economizer and compressor operation.
 - b. Independent modules for vertical or horizontal return configuration shall be available. Vertical return modules shall be available as a factory installed option.
 - c. Damper blades shall be galvanized steel with composite gears. Plastic or composite blades on intake or return shall not be acceptable.
 - d. Shall include all hardware and controls to provide free cooling with outdoor air when temperature and/or humidity are below setpoints.
 - e. Shall be equipped with gear driven dampers for both the outdoor ventilation air and the return air for positive air stream control
 - f. Ultra Low Leak design meets California Title 24 section 140.4 and ASHRAE90.1 requirements for 4 cfm per sq.ft. on the outside air dampers and 10 cfm per sq. ft. on the return dampers.
 - g. Economizer controller on EconoMi\$er X models shall be the Honeywell W7220 that provides:
 - (1.) 2-line LCD interface screen for setup, configuration and troubleshooting
 - (2.) On-board Fault Detection and Diagnostics (FDD) that senses and alerts when the economizer is not operating properly, per California Title 24.
 - (3.) Sensor failure loss of communication identification
 - (4.) Automatic sensor detection
 - (5.) Capabilities for use with multiple-speed indoor fan systems
 - (6.) Utilize digital sensors: Dry bulb and Enthalpy
 - h. Economizer controller on EconoMi\$er 2 models with RTU Open models shall be a 4-20mA design controlled directly by the RTU Open controller. RTU Open meets California Title 24 Fault Detection & Diagnostic (FDD) requirements.
 - i. Shall be capable of introducing up to 100% outdoor air.
 - j. Shall be equipped with a barometric relief damper capable of relieving up to 100% return air and contain seals that meet ASHRAE 90.1 requirements.
 - k. Shall be designed to close damper(s) during loss-of-power situations with spring return built into motor.
 - l. Dry bulb outdoor air temperature sensor shall be provided as standard. Enthalpy sensor is also available on factory installed only. Outdoor air sensor setpoint shall be adjustable and shall range from 40 to 100° F / 4 to 38° C. Additional sensor options shall be available as accessories.
 - m. The economizer controller shall also provide control of an accessory power exhaust unit function. Factory set at 100%, with a range of 0% to 100%.
 - n. The economizer shall maintain minimum airflow into the building during occupied period and provide design ventilation rate for full occupancy.
 - o. Dampers shall be completely closed when the unit is in the unoccupied mode.
 - p. Economizer controller shall accept a 2-10 Vdc CO₂ sensor input for IAQ/DCV control. In this mode, dampers shall modulate the outdoor air damper to provide ventilation based on the sensor input.
 - q. Compressor lockout temperature on W7220 is adjustable from -45° F to 80° F, set at a factory default of 32° F. Others shall open at 35°F (2°C) and closes at 50°F (10°C).
 - r. Actuator shall be direct coupled to economizer gear. No linkage arms or control rods shall be acceptable.

- s. Economizer controller shall provide indications when in free cooling mode, in the DCV mode, or the exhaust fan contact is closed.
- 3. Two-Position Damper (Factory installed on 3 Phase Models Only. Field installed on all 3 and 1 Phase Models)
 - a. Damper shall be a Two-Position Damper. Damper travel shall be from the full closed position to the field adjustable %-open setpoint.
 - b. Damper shall include adjustable damper travel from 25% to 100% (full open).
 - c. Damper shall include single or dual blade, gear driven dampers and actuator motor.
 - d. Actuator shall be direct coupled to damper gear. No linkage arms or control rods shall be acceptable.
 - e. Damper will admit up to 100% outdoor air for applicable rooftop units.
 - f. Damper shall close upon indoor (evaporator) fan shutoff and/or loss of power.
 - g. The damper actuator shall plug into the rooftop unit's wiring harness plug. No hard wiring shall be required.
 - h. Outside air hood shall include aluminum water entrainment filter
- 4. Manual damper
 - a. Manual damper package shall consist of damper, air inlet screen, and rain hood which can be preset to admit up to 50% outdoor air for year round ventilation.
- 5. Humidi-MiZer Adaptive Dehumidification System (3 Phase Models Only).
 - a. The Humidi-MiZer Adaptive Dehumidification System shall be factory-installed and shall provide greater dehumidification of the occupied space by two modes of dehumidification operations beside its normal design cooling mode:
 - (1.) Subcooling mode further subcools the hot liquid refrigerant leaving the condenser coil when both temperature and humidity in the space are not satisfied.
 - (2.) Hot gas reheat mode shall mix a portion of the hot gas from the discharge of the compressor with the hot liquid refrigerant leaving the condenser coil to create a two-phase heat transfer in the system, resulting in a neutral leaving- air temperature when only humidity in the space is not satisfied.
 - (3.) Includes Head Pressure Controller.
- 6. Head Pressure Control Package
 - a. Controller shall control coil head pressure by condenser-fan speed modulation or condenser-fan cycling and wind baffles.
 - b. Shall consist of solid-state control and condenser-coil temperature sensor to maintain condensing temperature between 90°F (32°C) and 110°F (43°C) at outdoor ambient temperatures down to -20°F (-29°C).
- 7. Condenser Coil Hail Guard Assembly (Factory installed on 3 Phase Models Only. Field installed on all 3 and 1 Phase Models)
 - a. Shall protect against damage from hail.
 - b. Shall be louvered design.
- 8. Unit-Mounted, Non-Fused Disconnect Switch (Available on units with MOCP's of 80 amps or less):
 - a. Switch shall be factory-installed, internally mounted.
 - b. National Electric Code (NEC) and UL approved non-fused switch shall provide unit power shutoff.
 - c. Shall be accessible from outside the unit
 - d. Shall provide local shutdown and lockout capability.
- 9. Convenience Outlet (3 Phase Models Only):
 - a. Powered convenience outlet.
 - (1.) Outlet shall be powered from main line power to the rooftop unit.
 - (2.) Outlet shall be powered from line side or load side of disconnect by installing contractor, as required by code. If outlet is powered from load side of disconnect, unit electrical ratings shall be UL certified and rated for additional outlet amperage.
 - (3.) Outlet shall be factory-installed and internally mounted with easily accessible 115-v female receptacle.
 - (4.) Outlet shall include 15 amp GFI receptacles with independent fuse protection.
 - (5.) Voltage required to operate convenience outlet shall be provided by a factory-installed step-down transformer.
 - (6.) Outlet shall be accessible from outside the unit.
 - (7.) Outlet shall include a field-installed "Wet in Use" cover.
 - b. Non-Powered convenience outlet.
 - (1.) Outlet shall be powered from a separate 115/120v power source.
 - (2.) A transformer shall not be included.

- (3.) Outlet shall be factory-installed and internally mounted with easily accessible 115-v female receptacle.
 - (4.) Outlet shall include 15 amp GFI receptacles with independent fuse protection.
 - (5.) Outlet shall be accessible from outside the unit.
 - (6.) Outlet shall include a field-installed "Wet in Use" cover.
10. Thru-the-Base Connectors:
 - a. Kits shall provide connectors to permit electrical connections to be brought to the unit through the unit basepan.
 - b. Minimum of four connection locations per unit.
11. Propeller Power Exhaust:
 - a. Power exhaust shall be used in conjunction with an integrated economizer.
 - b. Independent modules for vertical or horizontal return configurations shall be available.
 - c. Horizontal power exhaust is shall be mounted in return ductwork.
 - d. Power exhaust shall be controlled by economizer controller operation. Exhaust fans shall be energized when dampers open past the 0-100% adjustable setpoint on the economizer control.
12. Roof Curbs (Vertical):
 - a. Full perimeter roof curb with exhaust capability providing separate air streams for energy recovery from the exhaust air without supply air contamination.
 - b. Formed galvanized steel with wood nailer strip and shall be capable of supporting entire unit weight.
 - c. Permits installation and securing of ductwork to curb prior to mounting unit on the curb.
13. Thru-the-Bottom Utility Connectors:
 - a. Kit shall provide connectors to permit gas and electrical connections to be brought to the unit through the basepan.
14. Outdoor Air Enthalpy Sensor:
 - a. The outdoor air enthalpy sensor shall be used to provide single enthalpy control. When used in conjunction with a return air enthalpy sensor, the unit will provide differential enthalpy control. The sensor allows the unit to determine if outside air is suitable for free cooling.
15. Return Air Enthalpy Sensor:
 - a. The return air enthalpy sensor shall be used in conjunction with an outdoor air enthalpy sensor to provide differential enthalpy control.
16. Indoor Air Quality (CO₂) Sensor:
 - a. Shall be able to provide demand ventilation indoor air quality (IAQ) control.
 - b. The IAQ sensor shall be available in duct mount, wall mount, or wall mount with LED display. The setpoint shall have adjustment capability.
17. Smoke detectors (factory-installed only):
 - a. Shall be a Four-Wire Controller and Detector.
 - b. Shall be environmental compensated with differential sensing for reliable, stable, and drift-free sensitivity.
 - c. Shall use magnet-activated test/reset sensor switches.
 - d. Shall have tool-less connection terminal access.
 - e. Shall have a recessed momentary switch for testing and resetting the detector.
 - f. Controller shall include:
 - (1.) One set of normally open alarm initiation contacts for connection to an initiating device circuit on a fire alarm control panel.
 - (2.) Two Form-C auxiliary alarm relays for interface with rooftop unit or other equipment.
 - (3.) One Form-C supervision (trouble) relay to control the operation of the Trouble LED on a remote test/reset station.
 - (4.) Capable of direct connection to two individual detector modules.
 - (5.) Can be wired to up to 14 other duct smoke detectors for multiple fan shutdown applications.
18. Winter start kit
 - a. Shall contain a bypass device around the low pressure switch.
 - b. Shall be required when mechanical cooling is required down to 25°F (-4°C).
 - c. Shall not be required to operate on an economizer when below an outdoor ambient of 40°F (4°C).
19. Time Guard
 - a. Shall prevent compressor short-cycling by providing a 5-minute delay (±2 minutes) before restarting a compressor after shutdown for any reason.
 - b. One device shall be required per compressor.

20. Electric Heat:

a. Heating Section

- (1.) Heater element open coil resistance wire, nickel-chrome alloy, 0.29 inches inside diameter, strung through ceramic insulators mounted on metal frame. Coil ends are staked and welded to terminal screw slots.
- (2.) Heater assemblies are provided with integral fusing for protection of internal heater circuits not exceeding 48 amps each. Auto reset thermo limit controls, magnetic heater contactors (24 v coil) and terminal block all mounted in electric heater control box (minimum 18 ga galvanized steel) attached to end of heater assembly.

21. Hinged Access Panels

- a. Shall provide easy access through integrated quarter turn latches.
- b. Shall be on major panels of: filters, control box, fan motor and compressor.

