



turn to the experts™ 

DUAL-COMPRESSOR HERMETIC CENTRIFUGAL LIQUID CHILLER

# 19XRD

Cooling Capacity 8790-10548kW



Advanced dual compressor modular design, Energy-saving and High Efficiency, Reliability, Environmental Leadership, Easily Operated Control System

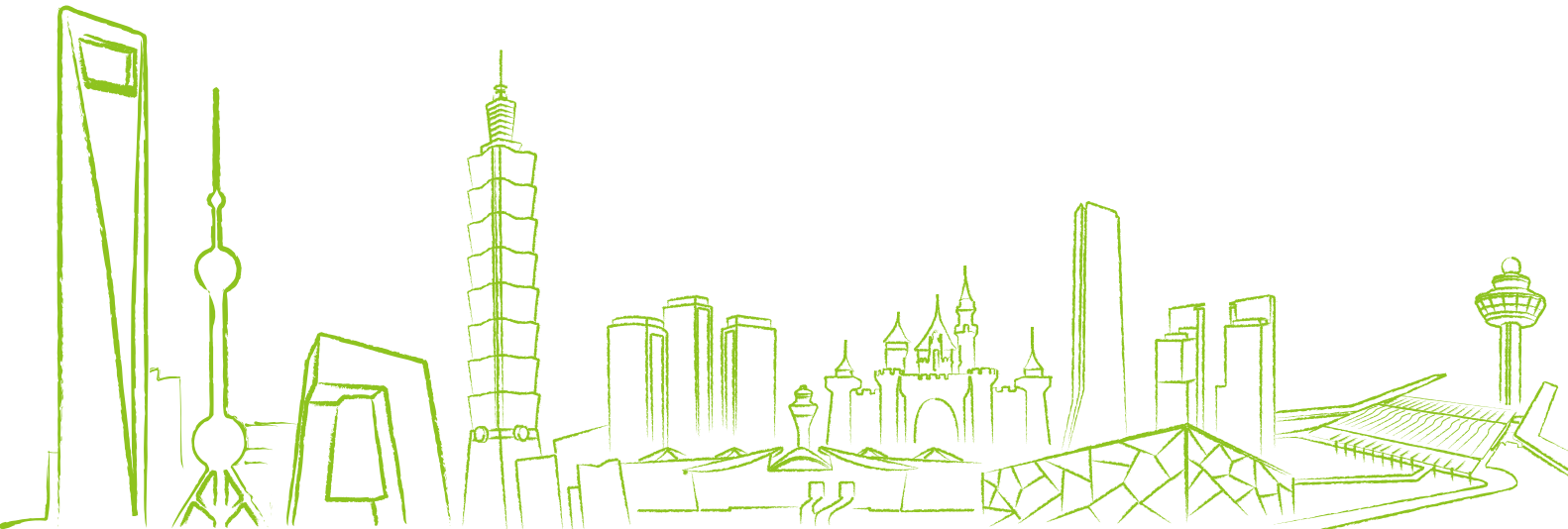

Carrier makes the world a better place to live by creating a comfortable, productive and healthy environment regardless of climate. It is our mission to be customer's first choice for air conditioning, heating and refrigeration solutions everywhere around the world.



The Great Hall of the People,  
Beijing, China



Kremlin, Moscow, Russia



White House, Washington DC, USA



Imperial Palace, Tokyo, Japan

# CONTENTS

- Nomenclature**
- Cooling Capacity** \_\_\_\_\_ 1
- Features and Benefits** \_\_\_\_\_ 2
- Selection Table** \_\_\_\_\_ 5
- Chiller Dimensions** \_\_\_\_\_ 6
- Nozzle Dimensions**
- Starter Dimensions** \_\_\_\_\_ 7
- Typical Piping and Wiring** \_\_\_\_\_ 8
- Types of Base Isolation** \_\_\_\_\_ 9
- Field Wiring** \_\_\_\_\_ 10
- Field Wiring Specifications**  
**(Free-Standing Starter)** \_\_\_\_\_ 12
- Guide Specifications** \_\_\_\_\_ 14

# Nomenclature

19XRD 5 TT UU 505 505 MF MF H 5A -

<p><b>Description</b> 19XRD: High-efficiency Dual-compressor Hermetic Centrifugal Liquid Chiller</p>											<p><b>Nonstandard Note</b> -:Standard F:Nonstandard</p>
<p><b>Heat Exchanger Frame Code</b> 5 (Note:Single digital indicates the same cooler/condenser frame code of two circuits)</p>										<p><b>Motor Voltage Code</b> 55-(6.6kV-3Ph-50Hz) 5A-(10kV-3Ph-50Hz) 5B-(11kV-3Ph-50Hz)</p>	
<p><b>Cooler Size</b> Motor End Circuit Compressor End Circuit Q-U</p>										<p><b>Motor Efficiency</b> H - High Efficiency S - Standard Efficiency</p>	
<p><b>Condensor Size</b> Motor End Circuit Compressor End Circuit Q-U</p>										<p><b>Motor Code</b> Compressor End Circuit MD, MF or others</p>	
<p><b>Compressor Code</b> Motor End Circuit</p>										<p><b>Motor Code</b> Motor End Circuit MD, MF or others</p>	
<p><b>Compressor Code</b> Compressor End Circuit</p>											

# Cooling Capacity

8790~10548kW

# Features and Benefits

## Advanced dual compressor modular design

- 19XRD includes two independent refrigerant circuits with two compressors in each circuit. Series counter flow design increases chiller's full load efficiency. Compared to single compressor chiller design, a dual compressor integrated design enhances part load performance. Chart 1 demonstrates part load performance between a single compressor chiller and a dual compressor chiller. When the chiller operates under 50% load, dual compressor chillers have significant operating cost savings versus single compressor chillers.
- Two compressors start up orderly and hence reduce the inrush current. Chart 2 illustrates inrush current between single compressor chillers and dual compressor chillers. A dual compressor chiller's inrush current is 60% of a single compressor chiller. Furthermore, dual compressors operate in turn and thus balance the compressors operating time and enlarge the service interval.
- A compact modular design saves operating room space and installation cost. At the same time independent refrigerant circuits provide redundancy.

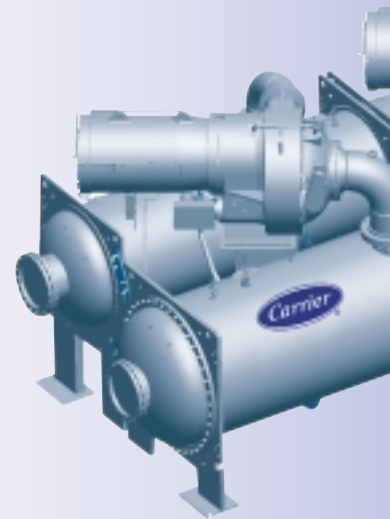
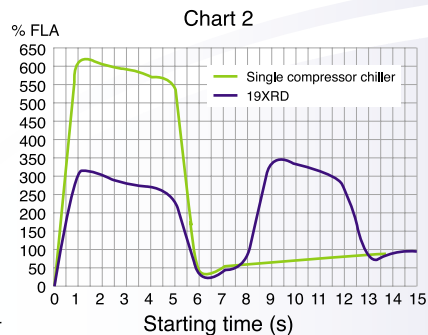
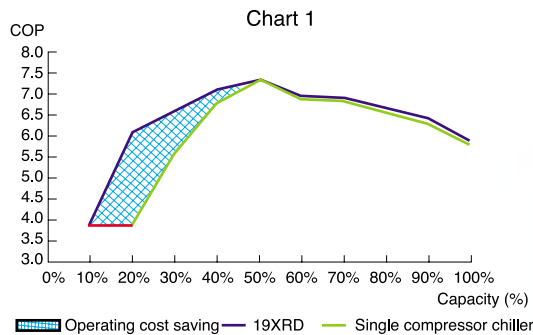

## One pass water box, customer's first choice

- Today's owners demand high efficiency from their air conditioning systems. Most of them focus on chillers' efficiency only and forget water pumps' power consumption. However a low water pressure dropped chiller also brings significant operating cost savings for owners. Charts 3 and 4 show operating costs among three different water pressure drop chillers. 19XRD condenser/cooler water pressure drop is 40/37KPa; chiller 1 condenser/cooler water pressure drop is 70/50KPa and chiller 2 condenser/cooler water pressure drop is 100/80 KPa. Compared to chiller 1, 19XRD saves \$8, 629 each year. And the 19XRD saves over \$20 thousand annually versus chiller 2. One pass water box offers low water pressure drop and significantly saves customers' operating cost.
- Ease of design and installation is another outstanding benefit for 19XRD's customers.

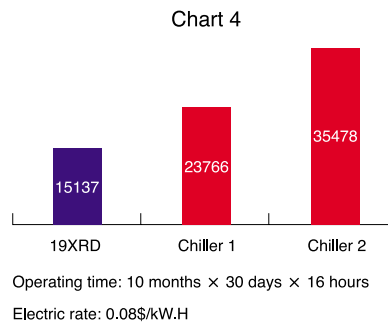
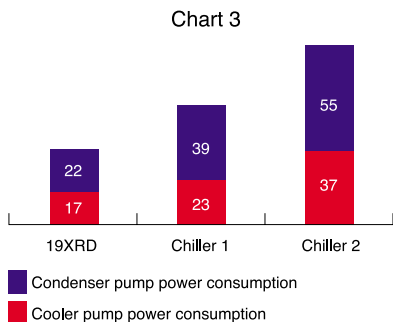

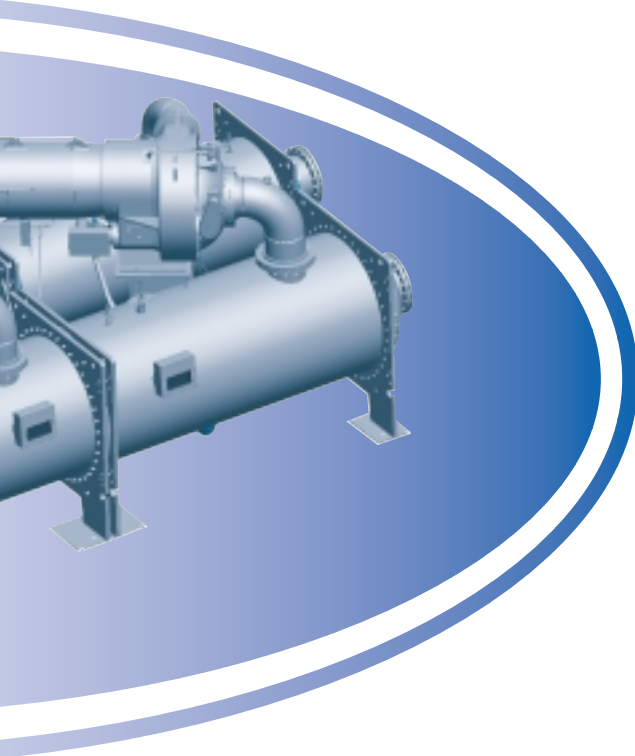
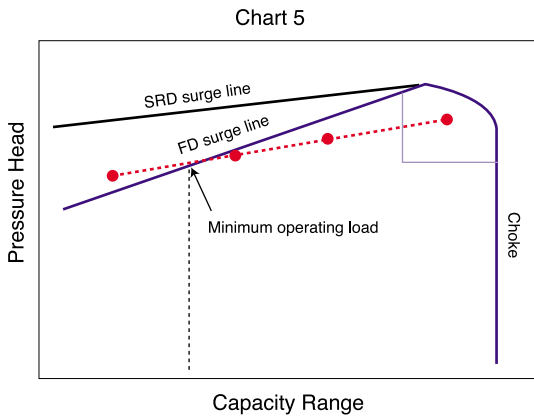

## Patented Split Ring Technology

- Per ARI 550/590-2003, chillers operate at design condition less than one percent of the time and superior part-load efficiency is required for today's chilled water application. Meanwhile due to high humidity weather condition, chillers operate on a constant condenser temperature frequently under part load and increase the surge risk.
- The 19XRD proceeds with 19XR families' technology and is equipped with patented Split Ring Technology, which is designed for Asian conditions.
- Chart 5 illustrates the wider operating range for SRD technology. As a result, 19XRD operates safely and more stable under constant condensed water part load conditions than fixed diffuser chillers.

**Aerodynamically contoured impellers** use high back sweep main blades with low-profile intermediate splitter blades. The impellers are aerodynamically contoured to improve compressor full-load and part-load operating efficiency.

**AccuMeter™ system** regulates refrigerant flow according to load conditions, providing a liquid seal at all operating conditions and eliminating unintentional hot gas by pass.

**Hermetic motors** are hermetically sealed from the machine room; cooling is accomplished by spraying liquid refrigerant on the motor windings, this highly efficient motor cooling method results in the use of smaller, cooler-running motors than could be realized with air-cooled designs of the same type.

In addition, Carrier's hermetic design eliminates:

- Compressor shaft seals that require maintenance and increase the likelihood of refrigerant leaks.
- Shaft alignment problems that occur with open-drive designs during start-up and operation, when equipment temperature variations cause thermal expansion.
- High noise levels that are common with air-cooled motors, which radiate noise to the machine room and adjacent areas.

**Single-stage design** increases product reliability by eliminating the additional moving parts associated with multiple stage chillers, such as additional guide vanes and complex economizers.



# Features and Benefits

## Environmental Leadership

- Carrier has long been committed to the environment and its sustainability. Evergreen chillers provide our customers with a high-efficiency, chlorine-free long-term solution unaffected by refrigerant phaseouts. Carrier's decision to utilize non-ozone depleting HFC-134a refrigerant provides our customers with a safe and environmentally sound choice without compromising efficiency.

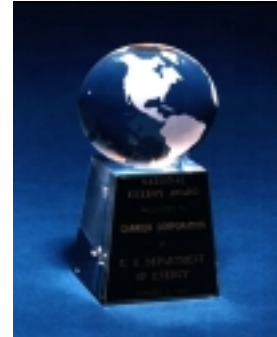

National Energy Award, D.O.E, USA

## Reliability

- By using the same 19XR simple and single stage positive-pressure compressor, 19XRD, ensures superior reliability and sustainability. Carrier's hermetic motors operate in a clean-liquid, refrigerant-cooled environment. The hermetic design eliminates the potential for shaft seal leaks and refrigerant/oil loss. These are just some of the reasons why the Evergreen family of chillers has the industry's lowest leak rate. Independent refrigerant and control circuits provide system redundancy and increase reliability. Dual compressors operate in turn and thus increase compressors' operating time and enlarge the service interval.



OZONE Protection Award, Environmental Protection Agency, USA

## Easily Operated Control System

- International Chiller Visual Control (ICVC) - a large English LCD (Liquid crystal display) features 4 menu-specific soft keys. The default display offers all in one glance review of key chiller operation data, simplifying the interaction between chiller and user.
- Direct digital Product Integrated Control (PIC II) - Automated controls test can be executed prior to start-up to verify that the entire control system is functioning properly. Carrier's PIC II integrates directly with the Carrier Comfort Network (CCN) via DATAPORT module, providing a system solution to controls Applications.



## Selection Table

Unit	Cooling Capacity	Tons	3000		
		kW	10548		
	Full Load Efficiency	ikW/kW	0.164	0.161	0.161
Motor	Motor Power	kV	6.6	10	11
	Frequency	Hz	50		
	Input Power of Two Motors	kW	1731	1698	1699
	Rated Load Current of Two Motors	A	118	108	111
	Locked Current for Single Y Motor	A	531	244	214
Evaporator	Flow Rate	L/s	458		
	Pressure Drop	kPa	53.3		
	Diameter of Connections	mm	DN450		
Condenser	Flow Rate	L/s	535		
	Pressure Drop	kPa	55.3		
	Diameter of Connections	mm	DN450		
Overall Dimension	Length	mm	8031		
	Width	mm	3261		
	Height	mm	3365		
Weight	Operating Weight	kg	45352		
	Rigging Weight	kg	40612		
	Recharge of R134a	kg	2222		

Notes: 1 Pass, Entering/leaving chilled water temperature:12.2°C/ 6.7°C; Entering/leaving cooled water temperature:29.5°C/ 35°C, Cooler fouling factor: 0.0176 m<sup>2</sup>.K/kW, Condenser fouling factor: 0.044 m<sup>2</sup>.K/kW, ARI turndown.

# Chiller Dimensions

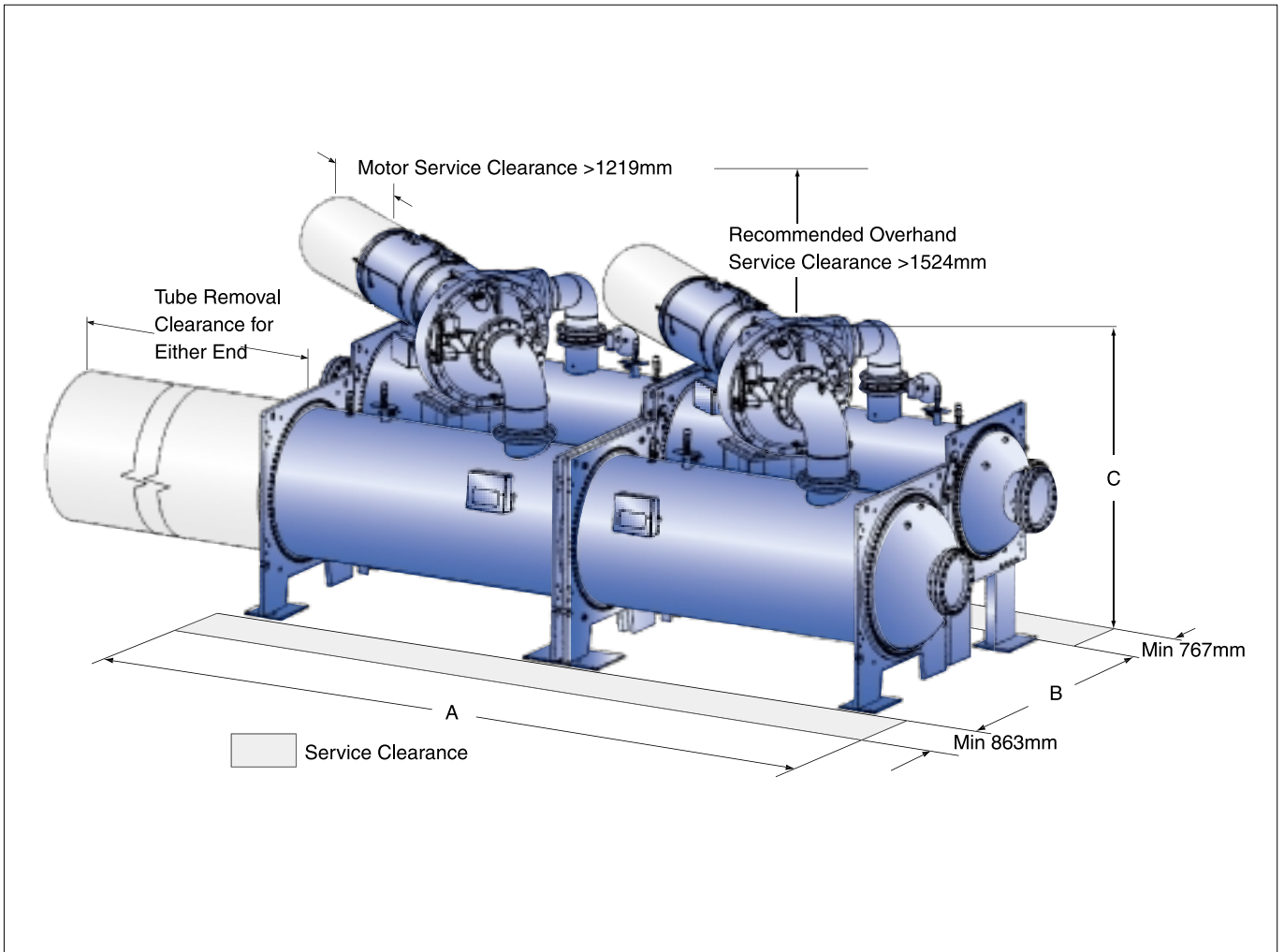

Heat Exchanger Size	A-Length mm	B-Width mm	C-Height mm	Tube Removal Space for Either End mm
5Q-5U	8031	3261	3365	3359

Note: 1. Waterbox Type: NIH. Motor end water inlet and compressor end water outlet for evaporator. Compressor end water inlet and Motor end water outlet for condenser.  
 2. A-length is based on the standard waterside pressure 1.0MPa. If waterside pressure increases or Marine type waterbox selected, length and width might be change.



## Nozzle Dimensions

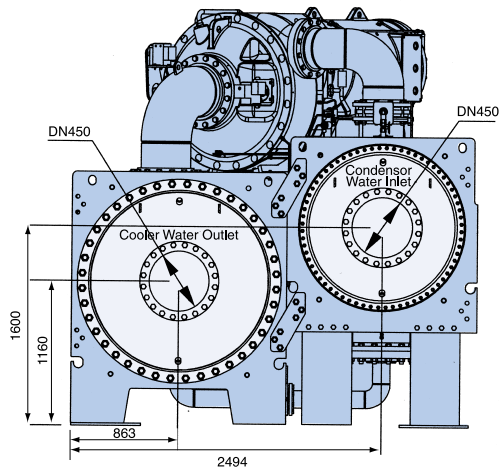

Compressor End View

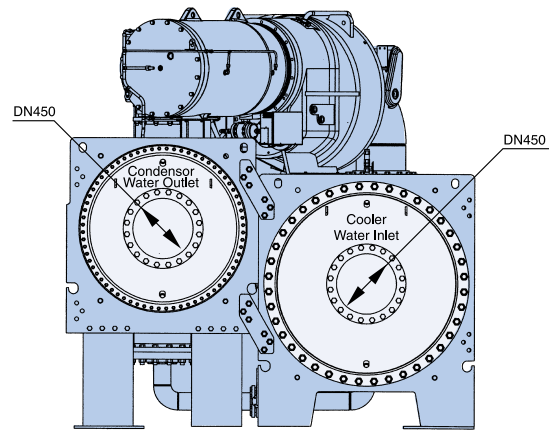

Motor End View

## Starter Dimensions

- \* Standard Starter Dimension  
(mm width × Depth × Height)  
1500 × 1300 × 2600  
Standard wiring of starter enters  
and exits from the top.
- \* Starter Dimension is for reference  
only, please contact Carrier's  
sales representative for detailed  
information

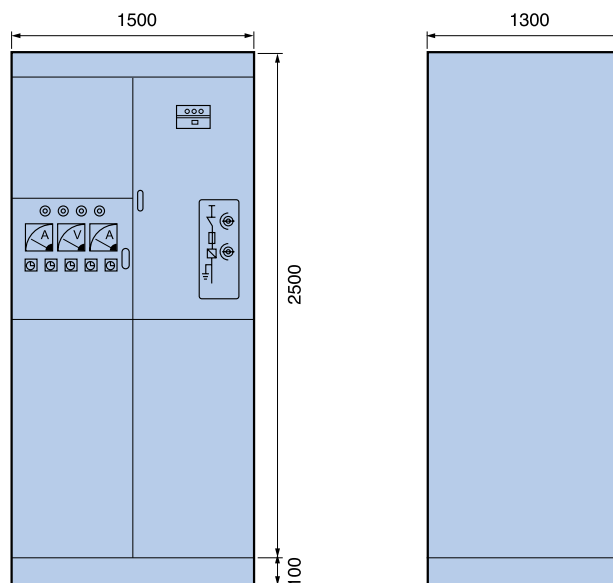

# Typical Piping and Wiring

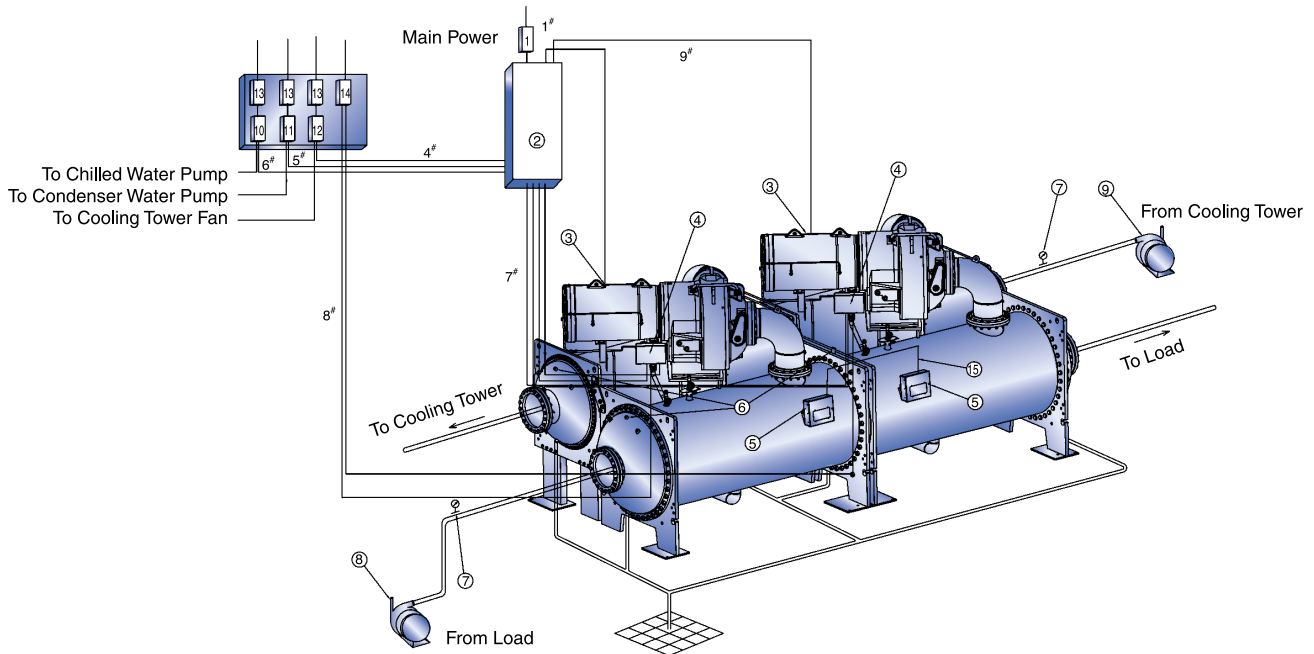

- |                                |  |                                  |                        |                                |
|--------------------------------|--|----------------------------------|------------------------|--------------------------------|
| 1. Air Switch                  | 2. Freestanding Compressor Motor Starter | 3. Compressor Motor Terminal Box | 4. Oil Pump Controller | 5. Control Panel               |
| 6. Vents                       | 7. Pressure Gauges                       | 8. Chilled Water Pump            | 9. Cooling Water Pump  | 10. Chilled Water Pump Starter |
| 11. Cooling Water Pump Starter | 12. Cooling Tower Fan Starter            | 13. Air Switch                   | 14. Oil Pump Switch    | 15. Communication line         |

Line	Purpose	Specification
1 <sup>#</sup>	Main power to Starter:	6.6~11kV AC: 3phases 1 grounding
4 <sup>#</sup>	To Cooling Tower Fan Starter:	2 control lines (optional)
5 <sup>#</sup>	To Cooling Water Pump Starter:	2 control lines (optional)
6 <sup>#</sup>	To Chilled Water Pump Starter:	2 control lines (optional)
7 <sup>#</sup>	To Oil Heater Contactor:	115V AC: 4 × 20A power lines, 1 grounding
8 <sup>#</sup>	Power to Oil Pump Contactor:	380V AC power line, 3 phases 5A
9 <sup>#</sup>	Starter to Main Motor:	6.6~11kV AC: 3 phases, 3 leads, 1 grounding

## Piping and Wiring Requirements:

- The installer must get all pipes and wires in place and mark the ends.
- Filters must be installed in cooling water and chilled water pipes.
- Thermometer (0-50°C) and pressure gauge (0~1MPa or 2MPa) must be installed at inlet and outlet of the pipes.
- The installer must install the relief valve vent to outdoors with a steel pipe (outer diameter 42mm, thickness 4mm).
- It is suggested that an oxygen content monitor be installed in the machine room for safety, which will give an alarm when the oxygen content is less than 19.5%.
- Option: Starter supplies oil Pump's Power directly.

# Types of Base Isolation

## Location of Isolator

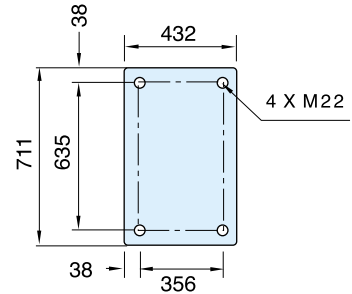
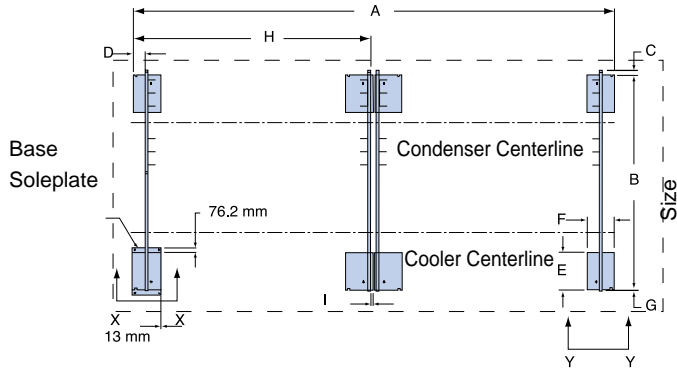

## Isolation

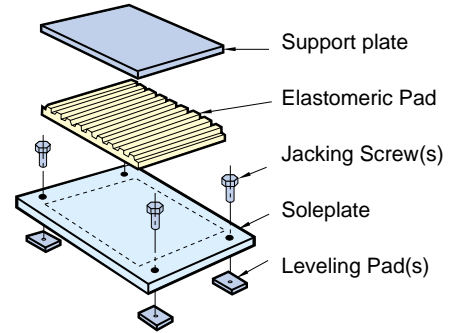
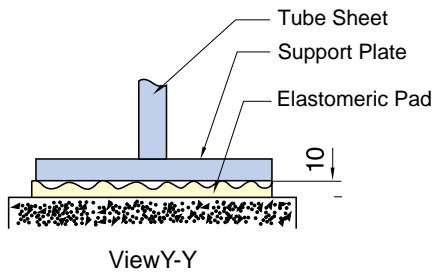

## Isolation

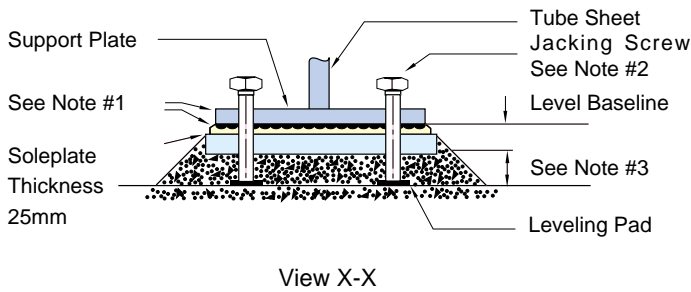

- Note: 1. Concrete base size should be add at least 4016 mm in Length and 1630 mm in Width. Level gradient < 1:1000.  
 2. Accessory soleplate package includes 8 soleplates, 32 jacking screws and 32 leveling pads per unit.  
 3. Jacking screws should be removed after the concrete base has been set.  
 4. The thickness of second concrete layer, depending on the necessary of chiller leveling adjustment.

Heat Exchanger Code	Base Size(mm)								
	A	B	C	D	E	F	G	H	I
5Q-5U	7129	3196	64	216	559	406	2	3554	25

# Field Wiring

## 19XRD Typical Field Wiring With Free-Sanding Starter

6.6kV/10kV/11kV-3Ph-50Hz

380V-3Ph-50Hz

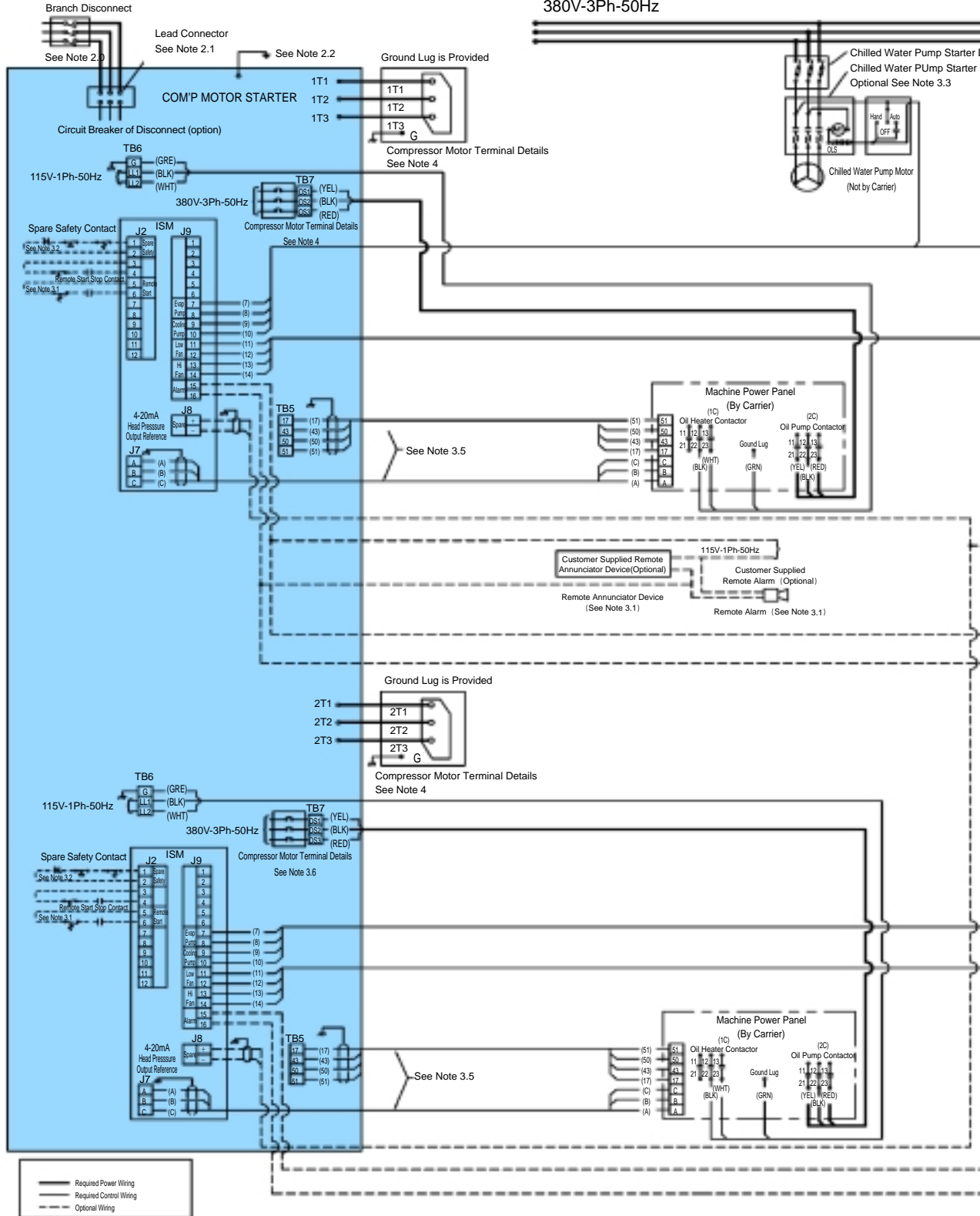

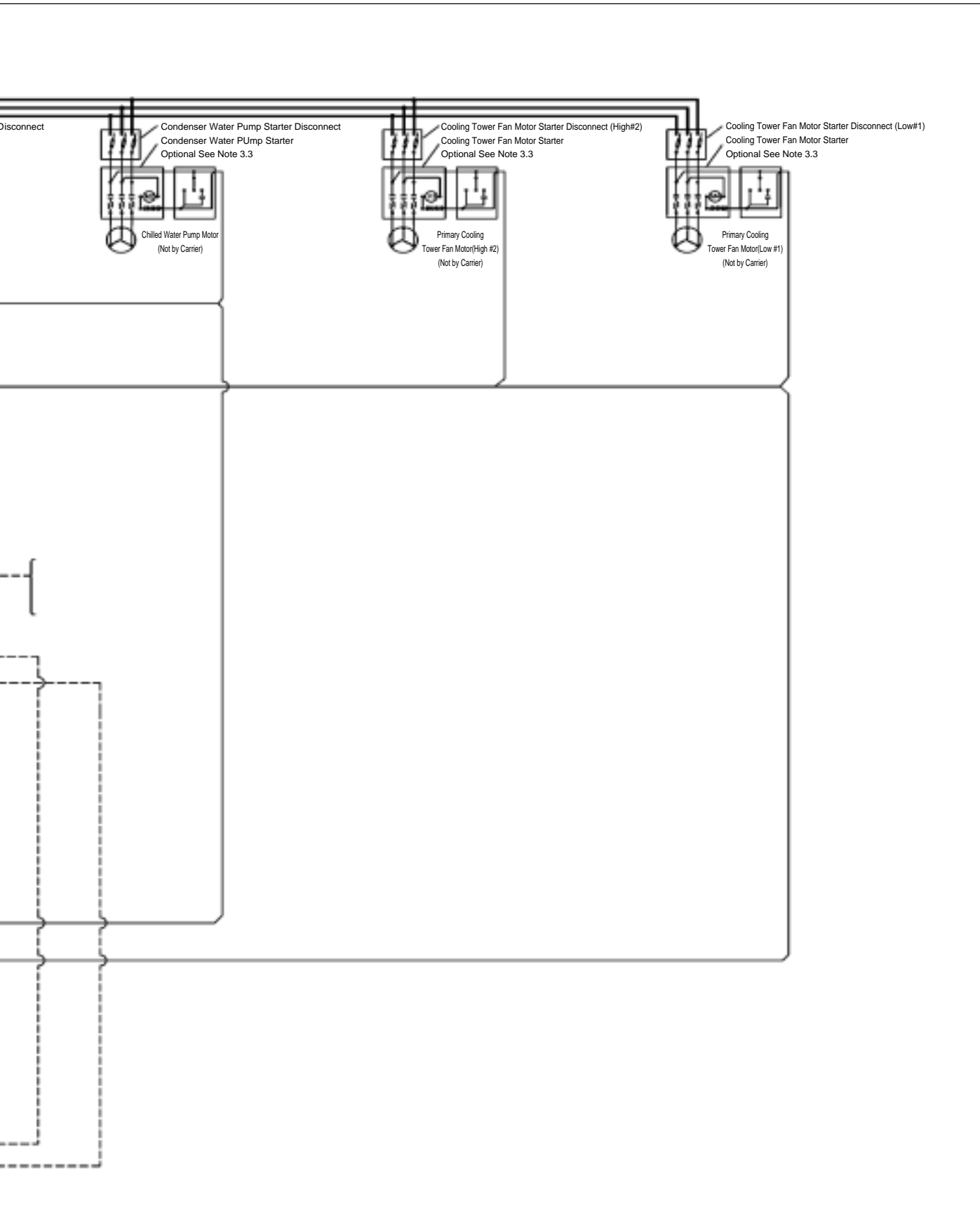

## Field Wiring Specifications (Free-Standing Starter)

### General

1. Starters shall be designed and manufactured in accordance with Carrier Engineering Requirement Z-415.
2. All field-supplied conductors, devices, and the field-installation wiring, termination of conductors and devices, must be in compliance with all applicable codes and job specifications.
3. The routing of field-installed conduit and conductors and the location of field-installed devices must not interfere with equipment access or the reading, adjusting, or servicing of any component.
4. Equipment installation and all starting and control devices, must comply with details in equipment submittal drawings and literature.
5. Contacts and switches are shown in the position with the circuit deenergized and the chiller shut down.
6. WARNING - Do not use aluminum conductors.
7. Installer is responsible for any damage caused by improper wiring between starter and machine.

### Power Wiring to Starter

1. Circuit breaker is to be used to disconnect power to starter.
2. Unit-mounted starter power conductor rating must meet minimum nameplate voltage and compressor motor RLA. Minimum ampacity per conductor =  $1.25 \times \text{compressor RLA}$
3. Lug adapters may be required if installation conditions dictate that conductors be sized beyond the minimum ampacity required.
4. Flexible conduit should be used for the last few feet of the power conductor to start enclosure to provide unit vibration isolation.
5. Compressor motor and controls must be grounded by using equipment-grounding lugs provided inside unit mounted starter enclosure.

### Control Wiring

1. Field supplied control conductors should be at least 1 mm<sup>2</sup> or larger.
2. Optional ice build start/terminate device contacts, optional remote start/stop device contacts and optional spare safety device contacts, must have 24 VAC rating. MAX current is 60 MA, nominal current is 10 MA. Switches with gold plated bifurcated contacts are recommended.
3. Remove jumper wire between J2-1 and J2-2 before connecting auxiliary safeties between these terminals.
4. ISM contact outputs can control cooler and condenser pump and tower fan motor contactor coil loads (VA) rated 5 Amps at 115 VAC up to 3 Amps at 220 VAC. Do not use starter control transformer as the power source for contactor coil loads.
5. Do not route control wiring carrying 30V or less within a conduit which has wires carrying 50V or higher or along side wires carrying 50V or higher.
6. Control wiring between free-standing starter and power panel must be separate shielded cables with minimum rating of 600V, 80°C Ground shield at starter.
7. If optional oil pump circuit breaker is not supplied within the starter enclosure as shown, it must be located within sight of the chiller with wiring routed to suit.

## Power Wiring Between Free-Standiing Starter and Compressor Motor

1. Medium voltage [over 600 volts] compressor motors have (3) terminals. Connections are 9/16-threaded stud. Compressor motor starter must have nameplate stamped as to conform with Carrier Engineering requirement "Z-415."
2. Power conductor rating must meet compressor motor RLA.  
Minimum ampacity per conductor = 1.25 x compressor RLA.
3. When more than one conduit is used to run conductors from starter to compressor motor terminal box, three leads from each phase (conductor) must be in each conduit to prevent excessive heating (e.g., conductors to motor terminals 1, 2, & 3 in one conduit, and those to 4, 5, & 6 in another).
4. Compressor motor power conductors may enter terminal box through top, bottom or right side using holes cut by contractor to suit conduit. Flexible conduit should be used for the last few feet to the terminal box for unit vibration isolation.
5. Compressor motor frame should be grounded in accordance with the National Electrical Code-us (NFPA-70) and applicable codes. Means for grounding compressor motor is a #4 AWG-500 MCM pressure connector, supplied and located in the lower left side corner of the compressor motor terminal box.
6. Do not allow motor terminals to support weight of wire cables. Use cable supports and strain relieves as required.
7. Use backup wrench when tightening lead connectors to motor terminal studs. Torque to 45 lb-ft max.
8. Motor terminals and wire connectors must be insulated with insulation putties and tapes attached to chillers to prevent moisture condensing and electrical arc.

## General

### 1.01 SYSTEM DESCRIPTION

- A. Microprocessor-controlled liquid chiller shall use a single stage, semi-hermetic centrifugal compressor using refrigerant HFC-134a.
- B. If a manufacturer proposes a liquid chiller using HCFC-123 refrigerant, then the manufacturer shall include in the chiller price:
  - 1. A vapor activated alarm system shall be capable of responding to HCFC-123 levels of 10 ppm Allowable Exposure Limit (AEL).
  - 2. External refrigerant storage tank and pumpout unit.
  - 3. Zero emission purge unit capable of operating even when the chiller is not operating.
  - 4. Back-up relief valve to rupture disk.
  - 5. Chiller pressurizing system to prevent leakage of noncondensables into chiller during shutdown periods.
  - 6. Plant room ventilation.

### 1.02 QUALITY ASSURANCE

- A. Chiller performance shall be rated in accordance with ARI Standard 550/590-2003.
- B. Equipment and installation shall be in compliance with ANSI/ASHRAE 15-2007.
- C. Cooler and condenser shall be compliant with China code GB150-1998, GB151-1999, JB/T4750-2003.
- D. Chiller shall be designed and constructed to meet China code GB/T18430.1-2001 requirement.
- E. Centrifugal compressor impellers shall be dynamically balanced and over-speed tested by the manufacturer at a minimum of 120% design operating speed. Each compressor assembly shall undergo a mechanical run-in test to verify vibration levels, oil pressures, and temperatures are within acceptable limits. Each compressor assembly shall be proof tested at a minimum 204 psig (1406 kPa) and leak tested at 185 psig (1276 kPa) with a tracer gas mixture.
- F. Entire chiller assembly shall be proof tested at 204 psig (1406 kPa) and leak tested at 185 psig (1276 kPa) with a tracer gas mixture on the refrigerant side. The water side of each heat exchanger shall be hydrostatically tested at 1.3 times rated working pressure.
- G. Prior to shipment, the chiller automated controls test shall be executed to check for proper wiring and ensure correct controls operation.

### 1.03 DELIVERY, STORAGE AND HANDLING

- A. Unit shall be stored and handled in accordance with manufacturer's instructions.
- B. Unit shall be shipped with all refrigerant piping and control wiring factory installed.
- C. Unit shall be shipped charged with oil and a nitrogen holding charge as specified or full charge of refrigerant HFC-134a as optional on the equipment schedule.
- D. Unit shall be shipped with firmly attached labels that indicate name of manufacturer, chiller model number, chiller serial number, and refrigerant used.
- E. If the chiller is to be exported, the unit shall be sufficiently protected from the factory against sea water corrosion to be suitable for shipment in a standard open top, ocean shipping container (after chiller be disassembled only).

### 1.04 WARRANTY

Warranty shall include parts and labor for one year after start-up or 18 months from shipment, whichever occurs first. A refrigerant warranty shall be provided for a period of five years.



## Products

### 2.01 EQUIPMENT

#### A. General:

Factory assembled liquid chiller shall consist of dual compressors. Each compressor shall consist of motor, starter, lubrication system, cooler, condenser, initial oil, microprocessor control system, and documentation required prior to start-up. An optional compressor motor starter and refrigerant operating charges can be provided by the chiller manufacturer.

#### B. Compressor:

1. Centrifugal compressors of the high performance, single-stage type.
2. Compressors, motor, and transmission shall be hermetically sealed into a common assembly and arranged for easy field servicing.
3. Internal compressor parts must be accessible for servicing without removing the compressor base from the chiller. Connections to the compressor casing shall use O-rings instead of gaskets to reduce the occurrence of refrigerant leakage. Connections to the compressor shall be flanged or bolted for easy disassembly.
4. Pressure transducers shall be capable of field calibration to ensure accurate readings and to avoid unnecessary transducer replacement. Transducers shall be serviceable without the need for refrigerant charge removal or isolation.
5. Transmission shall be single ratio, single helical, parallel shaft speed increaser. Gears shall conform to AGMA Standards, Quality II.
6. Journal bearings shall be of the steel backed babbitt lined type. The thrust bearing shall be tilting pad or rolling element type.
7. Centrifugal compressors shall use variable inlet guide vanes to provide capacity modulation while also providing pre-whirl of the refrigerant vapor entering the impeller for more efficient compression at all loads.
8. Centrifugal compressors shall be provided with a factory-installed lubrication system to deliver oil under pressure to bearings and transmission. Included in the system shall be:
  - a. Semi-hermetic driven rotary vane oil pump with factory-installed motor contactor with overload protection.
  - b. Refrigerant-cooled oil cooler.
  - c. Oil pressure regulator.
  - d. Oil filter with isolation valves to allow filter change without removal of refrigerant charge.
  - e. Oil sump heater controlled from unit microprocessor.
  - f. Oil reservoir temperature sensor with main control center digital readout.
  - g. Compressor shall be fully field serviceable.

#### C. Motor:

1. Compressor motor shall be of the semi-hermetic, liquid refrigerant cooled, squirrel cage, induction type suitable for voltage shown on the equipment schedule.
2. If an open drive motor is provided, a compressor shaft seal leakage containment system shall be provided:
  - a. An oil reservoir shall collect oil and refrigerant that leaks past the seal.
  - b. A float device shall be provided to open when the reservoir is full, directing the refrigerant/oil mixture back into the compressor housing.
  - c. A refrigerant sensor shall be located next to the open drive seal to detect leaks.
3. Motors shall be suitable for operation in a refrigerant atmosphere and shall be cooled by atomized refrigerant in contact with the motor windings.

4. Motor stator shall be arranged for service or removal with only minor compressor disassembly and without removing main refrigerant piping connections.
5. Full load operation of the motor shall not exceed nameplate rating.
6. One motor winding temperature sensor shall be provided.
7. Should the mechanical contractor choose to provide a chiller with an open motor instead of the specified semi-hermetic motor, the contractor shall install additional cooling equipment to dissipate the motor heat as per the following formula:

$$\text{Btuh} = (\text{FLkW motor}) (0.05) (3413)$$

$$\text{Btuh} = (\text{FLkW motor}) (171)$$

and, alternately

$$\text{Tons} = \text{Btuh} / 12,000$$

The additional piping, valves, air-handling equipment, insulation, wiring, switchgear changes, ductwork, and coordination with other trades shall be the responsibility of the mechanical contractor. Shop drawings reflecting any changes to the design shall be included in the submittal, and incorporated into the final as-built drawings for the project.

8. Also, if an open motor is provided, a mechanical room thermostat shall be provided and set at 104 F (40 C). If this temperature is exceeded, the chillers shall shut down and an alarm signal shall be generated to the central Energy Management System (EMS) display module prompting the service personnel to diagnose and repair the cause of the over temperature condition. The mechanical contractor shall be responsible for all changes to the design, including coordination with temperature control, electrical and other trades. In addition, the electrical power consumption of any auxiliary ventilation and/or mechanical cooling required to maintain the mechanical room conditions stated above shall be considered in the determination of conformance to the scheduled chiller energy efficiency requirement.

#### D. Cooler and Condenser:

1. Cooler shall be of shell and tube type construction with single pass. Units shall be fabricated with high-performance tubing, steel shell and tube sheets with fabricated steel waterboxes.
  - a. Waterbox shall be nozzle-in-head waterbox (150 psig).
  - b. Waterbox shall have standard nozzle flange compliant with China code JB/T 81-94.
2. Condenser shall be of shell and tube type construction with single pass. Units shall be fabricated with high-performance tubing, steel shell and tube sheets with fabricated steel waterboxes.
  - a. Waterbox shall be nozzle-in-head (150 psig).
  - b. Waterbox shall have standard nozzle flange compliant with China code JB/T 81-94.
3. Waterboxes shall have vents, drains, and covers to permit tube cleaning within the space shown on the drawings. A thermistor type temperature sensor shall be factory installed in each water nozzle.
4. Tubes shall be individually replaceable from end of the heat exchanger without affecting the strength and durability of the tube sheet and without causing leakage in adjacent tubes.
5. Tubing shall be copper, high-efficiency type, with integral internal and external enhancement unless otherwise noted. Tubes shall be nominal 3/4-in. OD with nominal wall thickness of 0.025 in. where the tubes are in contact with the end tube sheets unless otherwise noted. Tubes shall be rolled into tube sheets and shall be individually replaceable. Tube sheet holes shall be double grooved for joint structural integrity.
6. Cooler shall be designed to prevent liquid refrigerant from entering the compressor. Devices that introduce configured for either English or SI units.

- b. All chiller and starter monitoring shall be displayed at the chiller control panel.
- c. The controls shall make use of non-volatile memory.
- d. The chiller control system shall have the ability to interface and communicate directly to the building control system.
- e. The default standard display screen shall simultaneously indicate the following minimum information:
  - 1) date and time of day
  - 2) 24-character primary system status message
  - 3) 24-character secondary system status message
  - 4) chiller operating hours
  - 5) entering chilled water temperature
  - 6) leaving chilled water temperature
  - 7) evaporator refrigerant temperature
  - 8) entering condenser water temperature
  - 9) leaving condenser water temperature
  - 10) condenser refrigerant temperature
  - 11) oil supply pressure
  - 12) oil sump temperature
  - 13) percent motor Rated Load Amps (RLA)
- f. In addition to the default screen, status screens shall be accessible to view the status of every point monitored by the control center including:
  - 1) evaporator pressure
  - 2) condenser pressure
  - 3) bearing oil supply temperature
  - 4) compressor discharge temperature
  - 5) motor winding temperature
  - 6) number of compressor starts
  - 7) control point settings
  - 8) discrete output status of various devices
  - 9) compressor motor starter status
  - 10) optional spare input channels
  - 11) line current and voltage for each phase
  - 12) frequency, kW, kW-hr, demand kW
- g. Schedule Function:

The chiller controls shall be configurable for manual or automatic start-up and shutdown. In automatic operation mode, the controls shall be capable of automatically starting and stopping the chiller according to a stored user programmable occupancy schedule. The controls shall include built-in provisions for accepting:

  - 1) A minimum of two 365-day occupancy schedules.
  - 2) Minimum of 8 separate occupied/ unoccupied periods per day.
  - 3) Daylight savings start/end.
  - 4) 18 user-defined holidays.
  - 5) Means of configuring an occupancy timed override.
  - 6) Chiller start-up and shutdown via remote contact closure.
- h. Service Function:

The controls shall provide a password protected service function which allows authorized individuals to view

an alarm history file which shall contain the last 25 alarm/alert messages with time and date stamp. These messages shall be displayed in text form, not codes.

i. Network Window Function:

Each chiller control panel shall be capable of viewing multiple point values and statuses from other like controls connected on a common network, including controller maintenance data. The operator shall be able to alter the remote controller's set points or time schedule and to force point values or statuses for those points that are operator forcible. The control panel shall also have access to the alarm history file of all like controllers connected on the network.

j. Pump Control:

Upon request to start the compressor, the control system shall start the chilled water pump, condenser water pumps and verify that flows have been established.

k. Ramp Loading:

A user-configurable ramp loading rate, effective during the chilled water temperature pulldown period, shall control the rate of guide vane opening to prevent a rapid increase in compressor power consumption. The controls shall allow configuration of the ramp loading rate in either degrees/minute of chilled water temperature pulldown or percent motor amps/minute. During the ramp loading period, a message shall be displayed informing the operator that the chiller is operating in ramp loading mode.

l. Chilled Water Reset:

The control center shall allow reset of the chilled water temperature set point based on any one of the following criteria:

- 1) Chilled water reset based on an external 4 to 20 mA signal.
- 2) Chilled water reset based on a remote temperature sensor (such as outdoor air).
- 3) Chilled water reset based on water temperature rise across the evaporator.

m. Demand Limit:

The control center shall limit amp draw of the compressor to the rated load amps or to a lower value based on one of the following criteria:

- 1) Demand limit based on a user input ranging from 40% to 100% of compressor rated load amps.
- 2) Demand limit based on external 4 to 20 mA signal.

n. Controlled Compressor Shutdown:

The controls shall be capable of being configured to soft stop the compressor. When the stop button is pressed or remote contacts open with this feature active, the guide vanes shall close to a configured amperage level and the machine shall then shut down. The display shall indicate "shutdown in progress."

### 2. Safeties:

a. Unit shall automatically shut down when any of the following conditions occur: (Each of these protective limits shall require manual reset and cause an alarm message to be displayed on the control panel screen, informing the operator of the shutdown cause.)

- 1) motor overcurrent
- 2) over voltage\*
- 3) under voltage\*
- 4) single cycle dropout\*
- 5) bearing oil high temperature
- 6) low evaporator refrigerant temperature

- 7) high condenser pressure
- 8) high motor temperature
- 9) high compressor discharge temperature
- 10) low oil pressure
- 11) prolonged surge
- 12) loss of cooler water flow (when mounted with cooler water flow switch option)
- 13) loss of condenser water flow (when mounted with condenser water flow switch option)
- 14) starter fault

*\*Shall not require manual reset or cause an alarm if auto-restart after power failure is enabled.*

- b. The control system shall detect conditions that approach protective limits and take self-corrective action prior to an alarm occurring. The system shall automatically reduce chiller capacity when any of the following parameters are outside their normal operating range:
  - 1) high condenser pressure
  - 2) high motor temperature
  - 3) low evaporator refrigerant temperature
  - 4) high motor amps.
- c. During the capacity override period, a pre-alarm (alert) message shall be displayed informing the operator which condition is causing the capacity override. Once the condition is again within acceptable limits, the override condition shall be terminated and the chiller shall revert to normal chilled water control. If during either condition the protective limit is reached, the chiller shall shut down and a message shall be displayed informing the operator which condition caused the shutdown and alarm.
- d. Internal built-in safeties shall protect the chiller from loss of water flow when water flow switch option is mounted. Differential pressure switches shall not be allowed to be the only form of freeze protection.

### 3. Diagnostics and Service:

A self diagnostic controls test shall be an integral part of the control system to allow quick identification of malfunctioning components. Once the controls test has been initiated, all pressure and temperature sensors shall be checked to ensure they are within normal operating range. A guide vane actuator test shall open and close the guide vanes to check for proper operation. The operator manually acknowledges proper guide vane operation prior to proceeding to the next test. In addition to the automated controls test, the controls shall provide a manual test which permits selection and testing of individual control components and inputs. A thermistor test and transducer test shall display on the control screen the actual reading of each transducer and each thermistor installed on the chiller. All out-of-range sensors shall be identified.

#### G. Electrical Requirements:

1. Electrical contractor shall supply and install main electrical power line, disconnect switches, circuit breakers, and electrical protection devices per local code requirements and as indicated necessary by the chiller manufacturer.
2. Electrical contractor shall wire local electrical power line to the starter, and the starter power circuit to the chiller compressor motor.
2. Electrical contractor shall wire the starter control circuit and chiller power panel control circuit to the chiller control circuit.
3. Electrical contractor shall wire the chilled water pump, condenser water pump, and tower fan control circuit to the chiller control circuit.

## Guide Specifications

4. Electrical contractor shall supply and install electrical wiring and devices required to interface the chiller controls with the building control system if applicable.
  5. Electrical power shall be supplied to the unit at the voltages, phase, and frequency listed in the equipment schedule related to both compressor motor and oil pump.
- H. Piping Requirements™ Instrumentation and Safeties:  
Mechanical contractor shall supply and install pressure gages in readily accessible locations in piping adjacent to the chiller such that they can be easily read from a standing position on the floor. Scale range shall be such that design values shall be indicated at approximately mid-scale. Gages shall be installed in the entering and leaving water lines of the cooler and condenser.
- I. Vibration Isolation:  
Chiller manufacturer shall furnish neoprene isolator pads for mounting equipment on a level concrete surface.
- J. Start-up:
  1. The chiller manufacturer shall provide a factory-trained representative, employed by the chiller manufacturer, to perform the start-up procedures as outlined in the Start-up, Operation and Maintenance manual provided by the chiller manufacturer.
  2. Manufacturer shall supply the following literature:
    - a. Start-up, operation and maintenance instructions.
    - b. Installation instructions.
    - c. Field wiring diagrams.
    - d. One complete set of certified drawings.
- K. Field-Installed Accessories:  
The following standard accessories are available for field installation:
  1. Soleplate Package:  
Unit manufacturer shall furnish a soleplate package consisting of soleplates, jacking screws, leveling pads, and neoprene pads.
  2. Intermediate Waterbox Gasket:  
Unit manufacturer shall furnish intermediate waterbox gasket for cooler and condenser.
- L. Factory-Installed Options:
  1. Refrigerant Charge:  
The chiller shall ship from the factory fully charged with R-134a refrigerant.
  2. Thermal Insulation:  
Unit manufacturer shall insulate the cooler shell, compressor suction elbow, motor shell and motor cooling lines. Insulation shall be 3/4 in. (19 mm) thick with a thermal conductivity not exceeding 0.28 (Btu in.)/hr ft<sup>2</sup> F and shall conform to UL standard 94, classification 94 HBF.
  3. Cooler and Condenser Tubes:  
Contact local Carrier representative for other tube offerings.
  4. Nozzle-In-Head, 300 psig (2068 kPa):  
Unit manufacturer shall furnish nozzle-in-head style waterboxes on the cooler and/or condenser rated at 300 psig (2068 kPa).
  5. Marine Waterboxes, 150 psig (1034 kPa):  
Unit manufacturer shall furnish marine style waterboxes on cooler and/or condenser rated at 150 psig (1034 kPa).

6. Marine Waterboxes, 300 psig (2068 kPa):  
Unit manufacturer shall furnish marine style waterboxes on cooler and/or condenser rated at 300 psig (2068 kPa).
7. Stand-Alone Pumpout Unit:  
A free-standing pumpout shall be provided. The pumpout unit shall use a semi-hermetic reciprocating compressor with water-cooled condenser. Condenser water piping, 3-phase motor power shall be installed at the jobsite by the installing contractor.
8. Separate Storage Tank and Pumpout Unit:  
A free-standing refrigerant storage tank and pumpout unit shall be provided. The storage vessels shall be designed per China code GB150-1998, JB/T4750-2003 with 150 psig (1034 kPa) design pressure. Double relief valves per ANSI/ASHRAE15-2007, shall be provided. The tank shall include a liquid level gage and pressure gage. The pumpout shall use a semi-hermetic reciprocating compressor with water cooled condenser. Condenser water piping and 3-phase motor power shall be installed at the jobsite by the installing contractor.
9. Compressor Discharge Isolation Valve and Liquid Line Ball Valve:  
These items shall be factory installed to allow isolation of the refrigerant charge in the condenser for servicing the compressor.
10. Building Control System Interface (DataPort? or DataLINK?):  
The chiller control system shall have the ability to interface and communicate directly to the building control system without the use of additional field-installed hardware and software. The building control system and the centrifugal chiller must be supplied by the same manufacturer. If different building control and chiller suppliers are chosen the chiller shall be supplied with a DataPort or DataLINK module which shall translate the information in the chiller microprocessor to an ASCII stream of data which can be read or written to (with DataLINK only) by any manufacturer's building management control system.

Carrier Corporation identified six specific areas of concentration that directly impact how we, as a world manufacturer, balance our customers' needs for comfort with the environment's needs for responsible consumption.

