

25VNA
Infinity® Variable Speed Heat Pump
with Greenspeed™ Intelligence
2 to 5 Nominal Tons



Product Data

INDUSTRY LEADING FEATURES / BENEFITS



INFINITY™ SYSTEM

Carrier's 25VNA with Greenspeed™ Intelligence is a breakthrough product providing up to 13 HSPF heating efficiency and up to 20.5 SEER cooling efficiency. The variable speed capacity control results in strong heating capacity as the outdoor temperature drops resulting in less reliance on auxiliary heat. Lower speed operation, when needed in cooling, for enhanced comfort and dehumidification.

This product has been designed and manufactured to meet Energy Star® criteria for energy efficiency when matched with appropriate coil components. Refer to the combination ratings in the Product Data for system combinations that meet Energy Star® guidelines.

NOTE: Ratings contained in this document are subject to change at any time. Always refer to the AHRI directory (www.ahridirectory.org) for the most up-to-date ratings information.

Energy Efficiency

- 16.8 - 20 SEER/11.4 - 16 EER/10.3 - 13.0 HSPF
- Microtube Technology™ refrigeration system
- Indoor air quality accessories available

Sound

- Sound level as low as 58 dBA in low speed (Silencer System II).

Comfort

- Variable speed compressor with capacity range from 40-100%
- Air cooled Inverter variable speed drive
 - System requires Infinity Control with Greenspeed capability (SYSTXCCUID01-V or SYSTXCCUIZ01-V or newer)

Reliability

- Puron® refrigerant - environmentally sound, won't deplete the ozone layer and low lifetime service cost.
- Front-seating service valves
- Greenspeed Intelligence actively monitors critical system parameters
- High pressure switch
- Suction pressure transducer
- Electronic expansion valve (EXV) for heating, TXV for cooling
- Filter drier (field installed)
- External Muffler (field installed)
- Internal crankcase heater standard

Flexibility and installation:

- 2 control wires to outdoor unit
- Minimum and Maximum airflow adjustments
- Compressor Heating RPM control
- Hybrid Heat™ dual fuel capable

Durability

WeatherArmor Ultra™ protection package:

- Solid, Durable sheet metal construction
- Steel louver coil guard
- Baked-on, complete outer coverage, powder paint

Applications

- Long-line - up to 250 feet (76.2 m) total equivalent length, up to 200 feet (60.96 m) condenser above evaporator, or up to 80 ft. (24.38 m) evaporator above condenser (See Longline Guide for more information.)

MODEL NUMBER NOMENCLATURE

1	2	3	4	5	6	7	8	9	10	11	12	13
N	N	A	A	A/N	N	N	N	A/N	A/N	A/N	N	N
2	5	V	N	A	0	3	6	A	0	0	3	0
Product Series	Product Family	Tier	Major Series	SEER	Cooling Capacity	Variations	Open	Open	Voltage	Minor Series		
25 = HP	V = VS HP	N = Infinity Series	A = Puron	20 = SEER	1,000 Btuh (nominal)	A = Standard	0 = Not Defined	0 = Not Defined	3 = 208/230-1	0, 1, 2...		



Use of the AHRI Certified TM Mark indicates a manufacturer's participation in the program. For verification of certification for individual products, go to www.ahridirectory.org.



ISO 9001
QMI-SAI Global



This product has been designed and manufactured to meet Energy Star® criteria for energy efficiency when matched with appropriate coil components. However, proper refrigerant charge and proper air flow are critical to achieve rated capacity and efficiency. Installation of this product should follow all manufacturing refrigerant charging and air flow instructions. **Failure to confirm proper charge and air flow may reduce energy efficiency and shorten equipment life.**

25VNA



STANDARD FEATURES

FEATURES	Unit Size – Voltage, Series			
	24–30	36–30	48–30	60–30
Puron Refrigerant	X	X	X	X
Louvered Coil Guard	X	X	X	X
Field Installed Filter Drier / External Muffler	X	X	X	X
Front Seating Service Valves	X	X	X	X
Internal Pressure and Temperature Protection	X	X	X	X
Long Line capability	X	X	X	X
Suction Pressure Transducer	X	X	X	X
High Pressure Switch	X	X	X	X
Crankcase Heater	X	X	X	X
Low ambient cooling down to 0°F capability with Infinity Control	X	X	X	X
Utility Interface Connections	X	X	X	X
Enhanced Diagnostics with Infinity Control	X	X	X	X
Deluxe Sound Blanket	X	X	X	X
Outdoor Air Temperature Sensor	X	X	X	X

X = Standard

REFRIGERANT PIPING LENGTH LIMITATIONS

Maximum Line Lengths:

The maximum allowable total equivalent length for heat pumps varies depending on the vertical separation. See the tables below for allowable lengths depending on whether the outdoor unit is on the same level, above or below the indoor unit.

Maximum Line Lengths for Heat Pump Applications

	MAXIMUM ACTUAL LENGTH ft (m)	MAXIMUM EQUIVALENT LENGTH† ft (m)	MAXIMUM VERTICAL SEPARATION ft (m)
Units on equal level	200 (61)	250 (76.2)	N/A
Outdoor unit ABOVE indoor unit	200 (61)	250 (76.2)	200 (61)
Outdoor unit BELOW indoor unit	See Table 'Maximum Total Equivalent Length: Outdoor Unit BELOW Indoor Unit'		

† Total equivalent length accounts for losses due to elbows or fitting. See the Long Line Guideline for details.

Maximum Total Equivalent Length† - Outdoor Unit BELOW Indoor Unit

Size	Liquid Line Diameter w/ TXV	HP with Puron® Refrigerant – Maximum Total Equivalent Length† Vertical Separation ft (m) Outdoor unit BELOW indoor unit;						
		0–20 (0 – 6.1)	21–30 (6.4 – 9.1)	31–40 (9.4 – 12.2)	41–50 (12.5 – 15.2)	51–60 (15.5 – 18.3)	61–70 (18.6 – 21.3)	71–80 (21.6 – 24.4)
024 HP with Puron	3/8	250*	250*	250*	250*	250*	250*	250*
036 HP with Puron	3//8	250*	250*	250*	250*	250*	250*	250*
048 HP with Puron	3/8	250*	250*	250*	250*	230	160	--
060 HP with Puron	3/8	250*	225*	190	150	110	--	--

* Maximum actual length not to exceed 200 ft (61 m)

† Total equivalent length accounts for losses due to elbows or fitting. See the Long Line Guideline for details.

-- = outside acceptable range

LONG LINE APPLICATIONS

An application is considered Long Line when the refrigerant level in the system requires the use of accessories to maintain acceptable refrigerant management for systems reliability. Defining a system as long line depends on the liquid line diameter, actual length of the tubing, and vertical separation between the indoor and outdoor units.

For Heat Pump systems, the chart below shows when an application is considered Long Line. Beyond these lengths, long line accessories are required:

HP WITH PURON® REFRIGERANT LONG LINE DESCRIPTION ft (m) Beyond these lengths, long line accessories are required

Liquid Line Size	Units On Same Level	Outdoor Below Indoor	Outdoor Above Indoor
3/8	80 (24.4)	20 (6.1) vertical or 80 (24.4) total	80 (24.4)

Note: See Long Line Guideline for details

COOLING CAPACITY LOSS TABLE

Nominal Size (Btuh)	Line OD (in.)	25VNA Cooling Capacity Loss (%)										
		Total Equivalent Line Length (ft)										
		25	50	75	80	100	125	150	175	200	225	250
24000	5/8	0.5	1.2	1.8	1.9	2.4	3.0	3.7	4.3	4.9	5.5	6.2
	3/4	0.1	0.4	0.6	0.7	0.8	1.1	1.3	1.5	1.8	2.0	2.3
	7/8	0.0	0.1	0.3	0.3	0.4	0.5	0.6	0.7	0.8	1.0	1.1
36000	5/8	1.1	2.4	3.7	4.0	5.0	6.3	7.7	9.0	10.3	11.6	12.9
	3/4	0.3	0.8	1.3	1.4	1.8	2.3	2.8	3.2	3.7	4.2	4.7
	7/8	0.0	0.3	0.5	0.6	0.8	1.0	1.3	1.5	1.8	2.0	2.3
48000	3/4	0.7	1.6	2.4	2.6	3.2	4.1	4.9	5.7	6.5	7.4	8.2
	7/8	0.3	0.7	1.1	1.2	1.6	2.0	2.4	2.8	3.2	3.6	4.1
	1 1/8	0.0	0.1	0.2	0.3	0.4	0.5	0.6	0.7	0.8	0.9	1.0
60000	3/4	1.0	2.3	3.5	3.8	4.8	6.0	7.3	8.5	9.8	11.0	12.3
	7/8	0.4	1.0	1.7	1.8	2.3	2.9	3.5	4.2	4.8	5.4	6.0
	1 1/8	0.0	0.1	0.3	0.4	0.5	0.7	0.8	1.0	1.2	1.4	1.5

Rating Line Size in **Bold**

TE Length Greater than 80 ft requires Long Line Accessory Liquid Line Solenoid

25VNA

EQUIPMENT SIZING GUIDELINES

If primary load is cooling, size the same as any other air conditioning system. If primary load is heating, use the chart below for maximum size for heating.

MAXIMUM RECOMMENDED EQUIPMENT SIZE - HEATING

COOLING LOAD (tons)	MAXIMUM RECOMMENDED EQUIPMENT SIZE FOR HEATING*
2	36
2.5	36
3	48
3.5	60
4	60
5	60

* Make sure duct work is capable of delivering required airflow . Make sure combination rating exists for desired combination.

MIN/MAX AIRFLOW TABLES

The indoor airflow delivered by this system varies significantly based on outdoor temperature, indoor unit combination, and system demand. The airflows on these tables are for duct design considerations. Duct systems capable of these ranges will ensure

the system will deliver full capacity at all outdoor temperatures. Minimum and maximum airflows can be adjusted from these numbers in the Infinity Control Heat Pump Setup screen.

Cooling – Comfort Mode			Minimum Cooling (Dehum or Zoning)
Size	Max Capacity	Min Capacity	
24	726	651	398
36	1168	651	398
48	1394	1186	693
60	1650	1186	693

Cooling – Efficiency Mode		
Size	Max Capacity	Min Capacity
24	949	830
36	1334	830
48	1593	1355
60	1885	1355

Heating – Comfort Mode		
Size	Max Capacity	Min Capacity
24	698	440
36	1140	451
48	1354	751
60	1354	751

Heating – Efficiency Mode		
Size	Max Capacity	Min Capacity
24	900	750
36	1350	750
48	1600	890
60	1750	901

PHYSICAL DATA

UNIT SIZE SERIES	24-30	36-30	48-30	60-30
Operating Weight lb (kg)	324 (147)	324 (147)	334 (152)	334 (152)
Shipping Weight lb (kg)	367 (167)	367 (167)	375 (170)	375 (170)
Compressor Type	Variable Speed Scroll			
REFRIGERANT	Puron® (R-410A)			
Control	TXV (Puron® Hard Shutoff)			
Charge lb (kg)	13.12 (5.95)	13.12 (5.95)	13.30 (6.03)	13.30 (6.03)
Outdoor Htg Exp. Device	EXV	EXV	EXV	EXV
COND FAN	Forward Swept Propeller Type, Direct Drive			
Air Discharge	Vertical			
Air Qty (CFM)	2700	4269	4350	5000
Motor HP	1/3	1/3	1/3	1/3
Motor RPM	500-900	500-900	500-900	500-900
COND COIL				
Face Area (Sq ft)	30.25	30.25	30.25	30.25
Fins per In.	20	20	20	20
Rows	2	2	2	2
Circuits	8	8	9	9
VALVE CONNECT. (In. ID)				
Vapor	7/8	7/8	7/8	7/8
Liquid	3/8			
REFRIGERANT TUBES (In. OD)				
Rated Vapor*	7/8	7/8	1-1/8	1-1/8
Max Liquid Line	3/8			

* Units are rated with 25 ft (7.6 m) of lineset length. See Vapor Line Sizing and Cooling Capacity Loss table when using other sizes and lengths of lineset.

Note: See unit Installation Instruction for proper installation.

ACCESSORIES

KIT NUMBER	KIT NAME	24-30	36-30	48-30	60-30
KHAEM0101EMI	ELECTRO-MAGNETIC INTERFERENCE KIT	X	X	X	X
KHALS0401LLS	SOLENOID VALVE	X	X	X	X
KHASS0606MPK*	SNOW STAND	X	X	X	X
KSASF0101AAA	SUPPORT FEET	X	X	X	X
KSATX0301PUR	TXV	X	X		
KSATX0401PUR	TXV			X	
KSATX0501PUR	TXV				X
STANDARD	CRANKCASE HEATER	S	S	S	S

x = Accessory S = Standard * Available from RCD

CONTROLS

SYSTXCCITN01	Infinity Touch Control (non-Wi-Fi)
SYSTXCCITW01	Infinity Touch Control with Wi-Fi & Wireless Access Point
SYSTXCCUID01-V	Infinity Control Deluxe 7-Day Programmable (Wall-mounted system control.)
SYSTXCCUIZ01-V	Infinity Control Deluxe Zoning 7-Day Programmable (Wall-mounted control for a multi-zone system.)
SYSTXCC4ZC01	Infinity 4-Zone Damper Control Module (Wall-mounted control for a four-zone system.)
SYSTXCCSMS01	Infinity Smart Sensor (Optional wall control used to monitor temperature and/or fan control in an individual zone.)
SYSTXCCRRS01	Infinity Remote Room Sensor (Monitors temperature in an individual zone.)
SYSTXCCRCT01 or SYSTXCCRWF01	Infinity System Access Module (Hardware for wireless access and control via internet.)
SYSTXCCNIM01	Infinity Network Interface Module (Connects Heat Recovery and Energy Recovery Ventilators on non-zoning applications.)
SYSTXX0LBP01	Decorative Back Plate for Infinity Control (Decorative wall plate.)

ACCESSORY USAGE GUIDELINE

ACCESSORY	REQUIRED FOR LOW-AMBIENT COOLING APPLICATIONS (Below 55°F/12.8°C)	REQUIRED FOR LONG LINE APPLICATIONS* (Over 80 ft/24.38 m)	REQUIRED FOR SEA COAST APPLICATIONS (Within 2 miles/3.22 km)
Crankcase Heater	Standard	Standard	Standard
Evaporator Freeze Protection	Standard with Infinity™ Control	No	No
Liquid-Line Solenoid Valve	No	Yes	No
Low-Ambient Control	Standard with Infinity Control	No	No
Puron Refrigerant Balance Port Hard-ShutOff TXV	Yes†	Yes†	Yes†
Support Feet	Recommended	No	Recommended
Winter Start Control	Standard with Infinity Control	No	No

* For tubing set lengths between 80 and 200 ft. (24.38 and 60.96 m) horizontal or 20 ft. (6.10 m) vertical differential (total equivalent length), refer to the Long Line Guideline—Air Conditioners and Heat Pumps using Puron® Refrigerant.

† Required on all indoor units. Standard on all new Greenspeed™ compatible fan coils and furnace coils.

Accessory Description and Usage (Listed Alphabetically)

1. Compressor Start Assist

The inverter drive gently starts the variable speed compressor at all times. No other start device is compatible with this unit.

2. Crankcase Heater

Compressor motor winding resistance heater which is internal to compressor to keep the lubricant warm during off cycles. Improves compressor lubrication on restart and minimizes the chance of liquid slugging.

Usage:

Used in low ambient cooling applications.

Used in long line applications.

3. Liquid-Line Solenoid Valve (LLS)

An electrically operated shutoff valve which stops and starts refrigerant liquid flow in response to compressor operation. It is to be installed at the outdoor unit to control refrigerant off cycle migration in the heating mode.

Usage Guideline:

An LLS is required in all long line heat pump applications to control refrigerant off cycle migration in the heating mode. See Long Line Guideline.

Suggested for all commercial applications.

4. Snow Stand

Coated wire rack which supports unit 18 in. (457.2 mm) above mounting pad to allow for drainage from unit base.

Usage Guideline:

Suggested in the following applications:

Heat pump installations in heavy snowfall areas.

Heat pump installations in snow drift locations.

Heat pump installations in areas of prolonged subfreezing temperatures.

All commercial installations.

5. Thermostatic Expansion Valve (TXV) Bi-Flow

A modulating flow-control valve which meters refrigerant liquid flow rate into the evaporator in response to the superheat of the refrigerant gas leaving the evaporator.

Usage Guideline:

Accessory required to meet AHRI rating and system reliability, where indoor not equipped.

Required in all heat pump applications designed with Puron refrigerant.

6. Electro-Magnetic Interference Kit

Usage Guideline:

May be required to address radio frequency interference for equipment, such as HAM radios, operating between 6 and 30 MHz.

ELECTRICAL DATA

UNIT SIZE – VOLTAGE, SERIES	V/PH	OPER VOLTS*		COMPR		FAN	MCA	MIN WIRE SIZE†	MIN WIRE SIZE†	MAX LENGTH ft (m)‡	MAX LENGTH ft (m)‡	MAX FUSE* * or CKT BRK AMPS
		MAX	MIN	LRA	RLA	FLA		60°C	75°C	60°C	75°C	
		24–30	208–230–1	253	197	24		16.5	2.9	23.5	12	
36–30	24	16.5				2.9	23.5	12	12	52 (15.9)	50 (16.2)	40
48–30	42	27.0				2.9	36.6	8	8	84 (25.6)	80 (24.3)	50
60–30	42	27.0				2.9	36.6	8	8	84 (25.6)	80 (24.3)	50

* Permissible limits of the voltage range at which the unit will operate satisfactorily

† If wire is applied at ambient greater than 30°C, consult table 310–16 of the NEC (NFPA 70). The ampacity of non–metallic–sheathed cable (NM), trade name ROMEX, shall be that of 60°C conditions, per the NEC (NFPA 70) Article 336–26. If other than uncoated (no–plated), 60 or 75°C insulation, copper wire (solid wire for 10 AWG or smaller, stranded wire for larger than 10 AWG) is used, consult applicable tables of the NEC (NFPA 70).

‡ Length shown is as measured 1 way along wire path between unit and service panel for voltage drop not to exceed 2%.

** Time–Delay fuse.

FLA – Full Load Amps

LRA – Locked Rotor Amps

MCA – Minimum Circuit Amps

RLA – Rated Load Amps

NOTE: Control circuit is 24–V on all units and requires external power source. Copper wire must be used from service disconnect to unit.

All motors/compressors contain internal overload protection.

Complies with 2010 requirements of ASHRAE Standards 90.1

SOUND POWER LEVEL (dBA)

Unit Size – Voltage, Series	Typical Octave Band Spectrum (without tone adjustment)	Min Speed Cooling	Max Speed Cooling	*Min Speed Heating	*Max Speed Heating
024–30	Freq (Hz)	1800 RPM	3200 RPM	1800 RPM	5700 RPM
	125	62.0	63.0	63.0	73.5
	250	57.0	56.5	61.5	63.0
	500	54.5	57.5	58.5	66.0
	1000	52.0	58.0	54.5	63.5
	2000	47.5	54.0	51.5	64.5
	4000	44.5	48.0	48.0	59.5
	8000	52.5	54.5	54.0	61.5
	Sound Rating (dBA)	58	63	62	71
036–30	Freq (Hz)	1800 RPM	4500 RPM	1800 RPM	6850**
	125	62.0	64.5	63.0	67.0
	250	57.0	60.5	61.5	67.5
	500	54.5	61.0	58.5	69.0
	1000	52.0	61.0	54.5	67.0
	2000	47.5	56.0	51.5	67.0
	4000	44.5	51.0	48.0	63.0
	8000	52.5	54.5	54.0	61.5
	Sound Rating (dBA)	58	65	62	75
048–30	Freq (Hz)	1800 RPM	3450 RPM	1800 RPM	6300**
	125	62.0	70.0	66.0	73.5
	250	60.5	67.5	63.0	69.5
	500	56.0	67.0	63.0	73.5
	1000	59.0	63.0	58.0	72.0
	2000	54.0	60.0	53.5	66.5
	4000	52.5	56.0	50.0	65.5
	8000	58.5	58.5	57.0	63.0
	Sound Rating (dBA)	65	70	64	76
060–30	Freq (Hz)	1800 RPM	4250 RPM	1800 RPM	6300**
	50	62.0	65.0	66.0	73.5
	100	60.5	67.5	63.0	69.5
	200	56.0	67.5	63.0	73.5
	400	59.0	66.5	58.0	72.0
	800	54.0	61.0	53.5	66.5
	1600	52.5	60.5	50.0	65.5
	3150	58.5	59.0	57.0	63.0
	Sound Rating (dBA)	65	72	64	76

NOTE: Tested in compliance with AHRI 270–2008 but not listed with AHRI.

* 024 & 036 tested at 44°F Outdoor Air Temperature. 048 & 060 tested at 40°F

**Testable RPM limited by outdoor temp. Max unit RPM is 6500 for the 4 ton and 7000 for the 3 and 5 ton.

CHARGING SUBCOOLING (TXV-TYPE EXPANSION DEVICE)

UNIT SIZE – VOLTAGE, SERIES	REQUIRED SUBCOOLING °F (°C) – See UI
24–30	Subcooling recommendation displayed on UI in Charging Mode must be followed
36–30	
48–30	
60–30	

25VNA

DIMENSIONS - ENGLISH

UNIT	SERIES	ELECTRICAL CHARACTERISTICS	A	B	C	D	E	F	G	K	L	M	N	P	OPERATING WEIGHT (lbs)	SHIPPING WEIGHT (lbs)	SHIPPING DIMENSIONS (L x W x H)
25VNA024	0	X 0 0 0	35"	44"	3 7/8"	7/8"	6 9/16"	28 7/16"	9 1/8"	2 15/16"	5/8"	16 1/4"	16 1/4"	21 1/4"	324	367	36 1/8" X 39 1/4" X 50 3/16"
25VNA036	0	X 0 0 0	35"	44"	3 7/8"	7/8"	6 9/16"	28 7/16"	9 1/8"	2 15/16"	5/8"	16 1/4"	16 1/4"	21 1/4"	324	367	36 1/8" X 39 1/4" X 50 3/16"
25VNA048	0	X 0 0 0	35"	44"	3 7/8"	7/8"	6 9/16"	28 7/16"	9 1/8"	2 15/16"	5/8"	16 1/4"	16 1/4"	21 1/4"	334	375	36 1/8" X 39 1/4" X 50 3/16"
25VNA060	0	X 0 0 0	35"	44"	3 7/8"	7/8"	6 9/16"	28 7/16"	9 1/8"	2 15/16"	5/8"	16 1/4"	16 1/4"	21 1/4"	334	375	36 1/8" X 39 1/4" X 50 3/16"

208-230-160	460-3-60
230-160	208/230-3-60

X = YES
O = NO

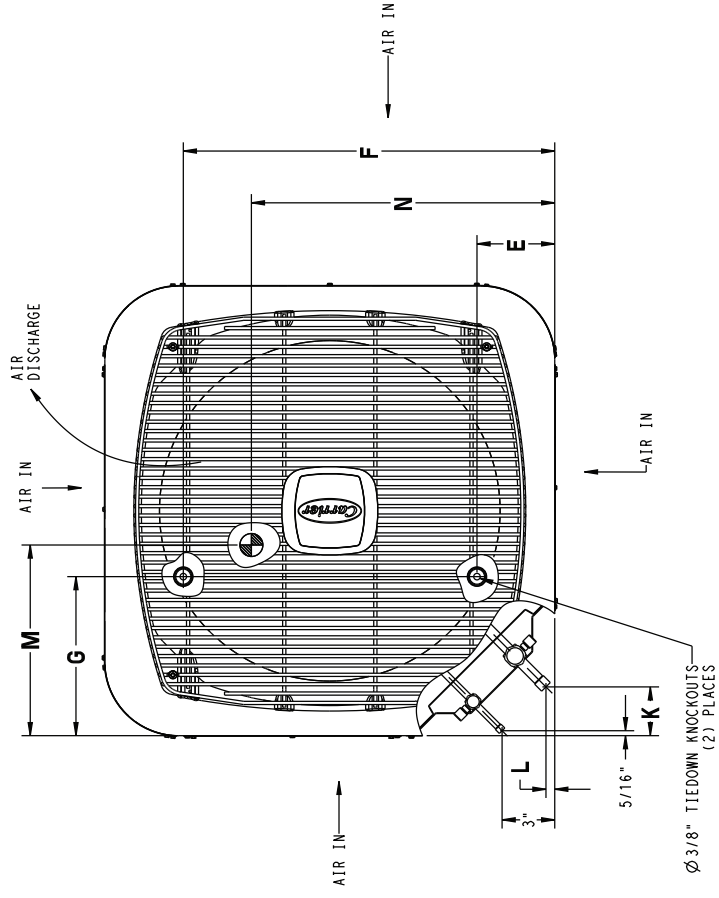
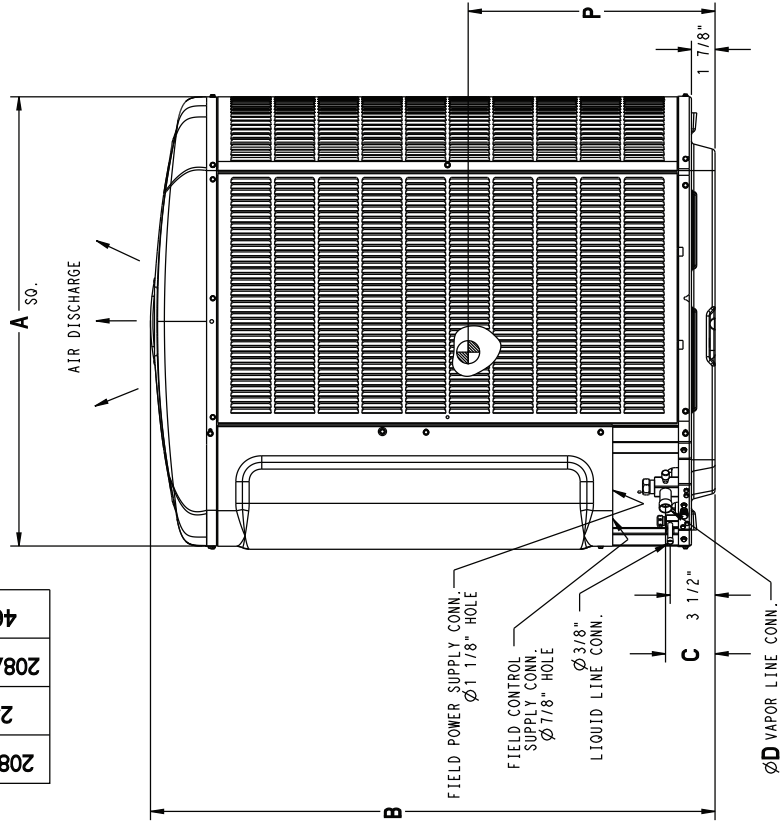

UNIT SIZE	MINIMUM MOUNTING PAD DIMENSIONS
-	31 1/2" X 31 1/2"
24, 36, 48, 60	35" X 35"

DIMENSIONS - SI

UNIT	SERIES	ELECTRICAL CHARACTERISTICS	A	B	C	D	E	F	G	K	L	M	N	P	OPERATING WEIGHT (Kgs)	SHIPPING WEIGHT (Kgs)	SHIPPING DIMENSIONS (L x W x H)
25VNA024	0	X 0 0 0	889.0	1116.7	98.4	22.2	166.7	722.3	231.8	74.6	15.9	412.8	412.8	539.8	147	167	917.7 X 997.7 X 1274.9
25VNA036	0	X 0 0 0	889.0	1116.7	98.4	22.2	166.7	722.3	231.8	74.6	15.9	412.8	412.8	539.8	147	167	917.7 X 997.7 X 1274.9
25VNA048	0	X 0 0 0	889.0	1116.7	98.4	22.2	166.7	722.3	231.8	74.6	15.9	412.8	412.8	539.8	152	170	917.7 X 997.7 X 1274.9
25VNA060	0	X 0 0 0	889.0	1116.7	98.4	22.2	166.7	722.3	231.8	74.6	15.9	412.8	412.8	539.8	152	170	917.7 X 997.7 X 1274.9

X = YES
O = NO

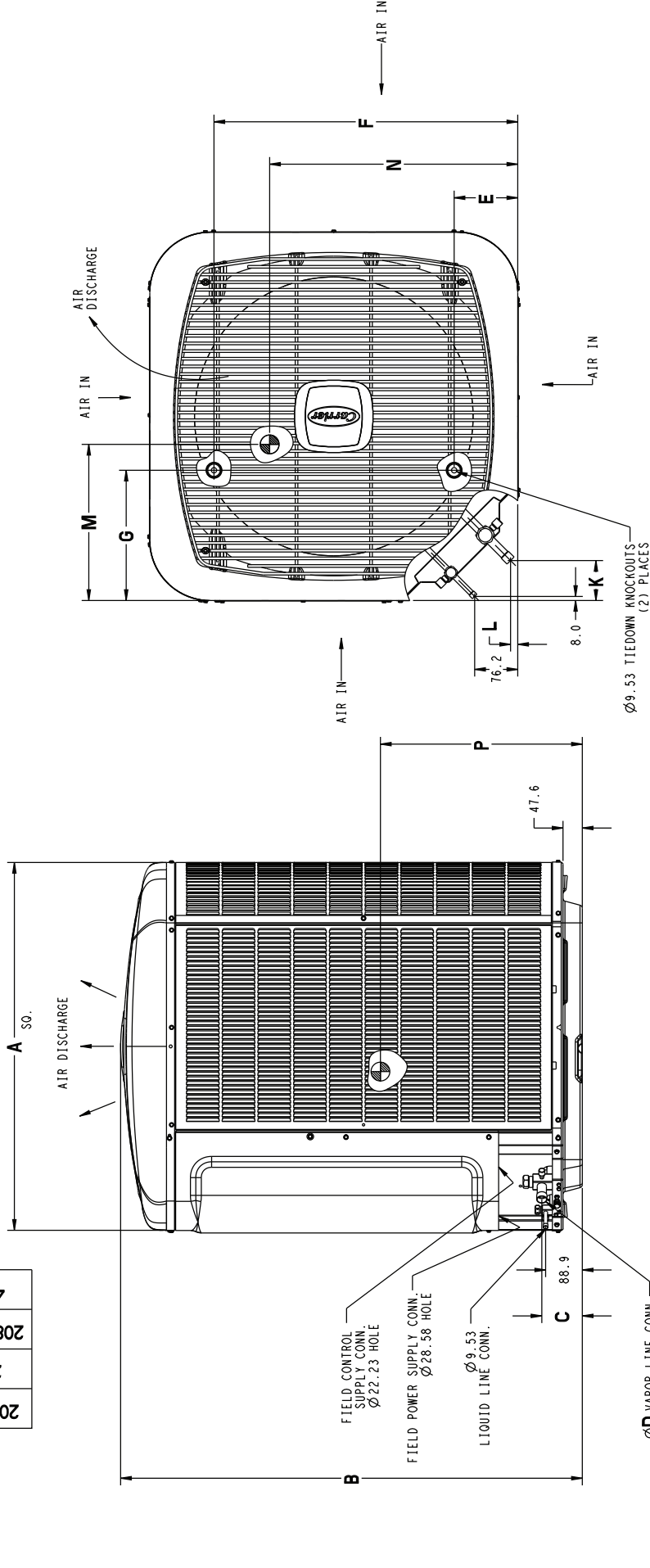

UNIT SIZE	MINIMUM MOUNTING PAD DIMENSIONS
-	800.1 X 800.1
24.36, 48.60	889.0 X 889.0

25VNA

25VNA BALANCE POINT WORKSHEET

25VNA024 BALANCE POINT WORK SHEET
(MINIMUM & MAXIMUM HEATING CAPACITIES)

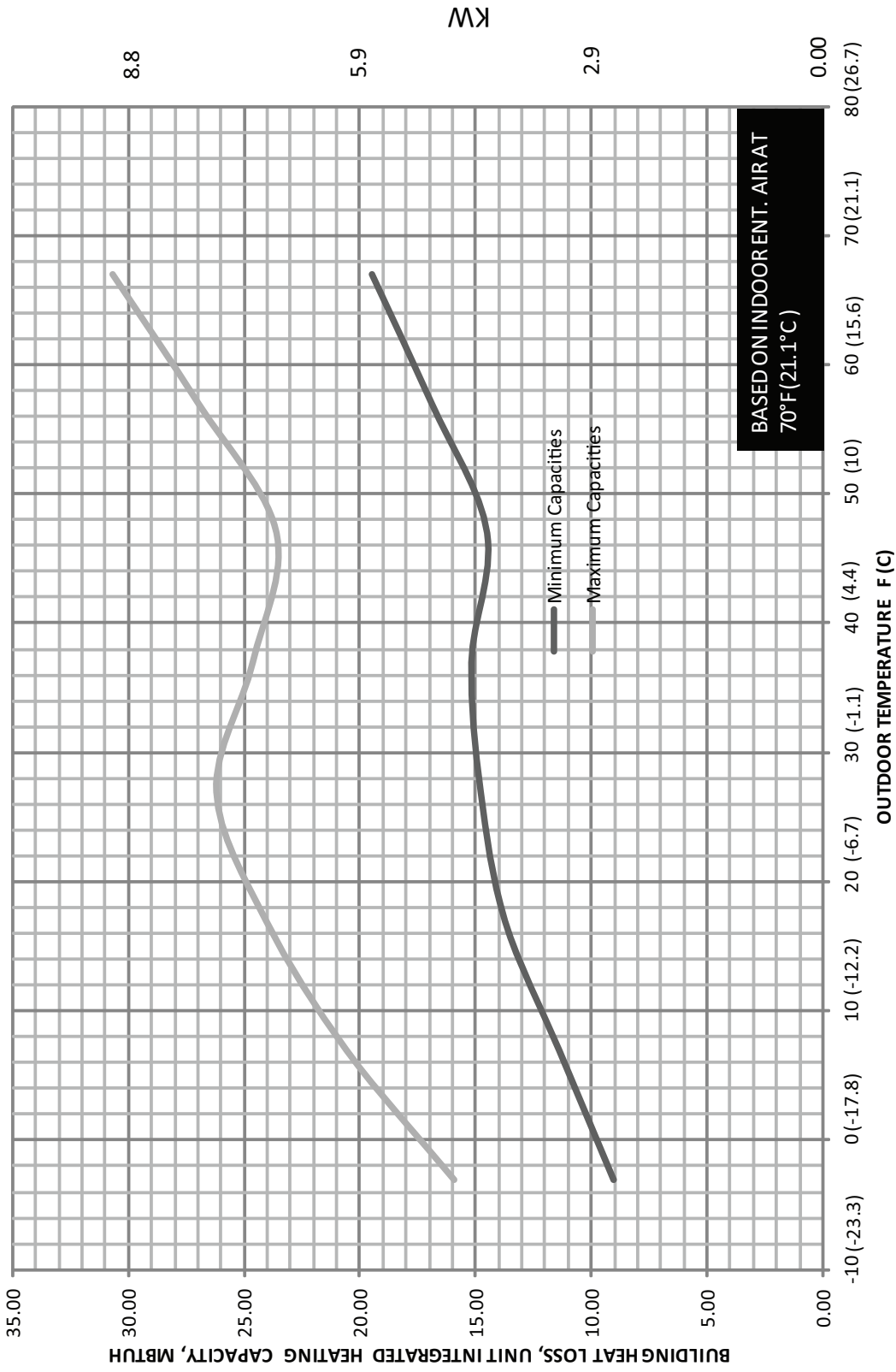

**25VNA036 BALANCE POINT WORKSHEET
(MINIMUM & MAXIMUM DELIVERABLE HEATING CAPACITIES)**

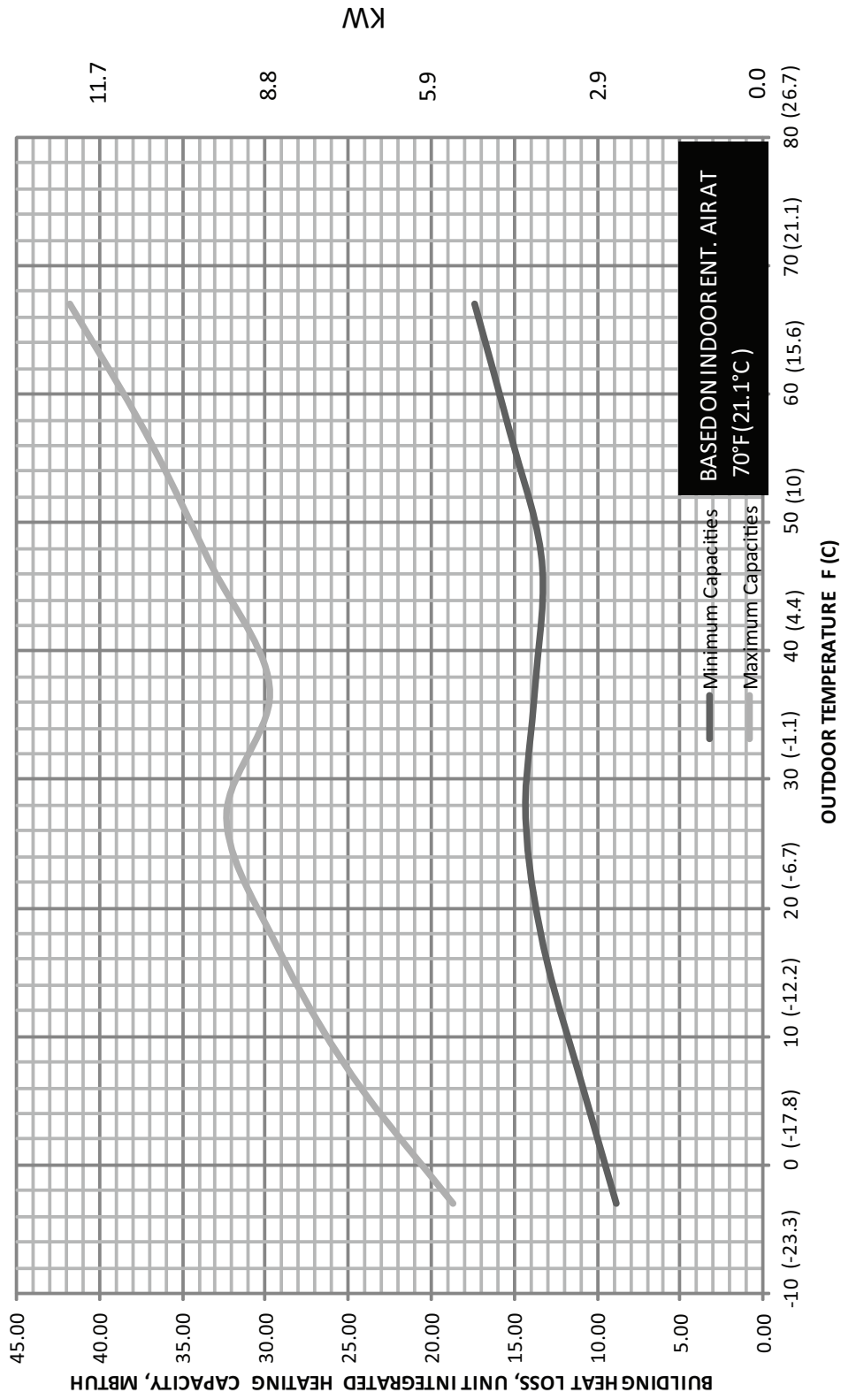

25VNA BALANCE POINT WORKSHEET CONT.

25VNA048 BALANCE POINT WORK SHEET
 MINIMUM AND MAXIMUM HEATING CAPACITIES

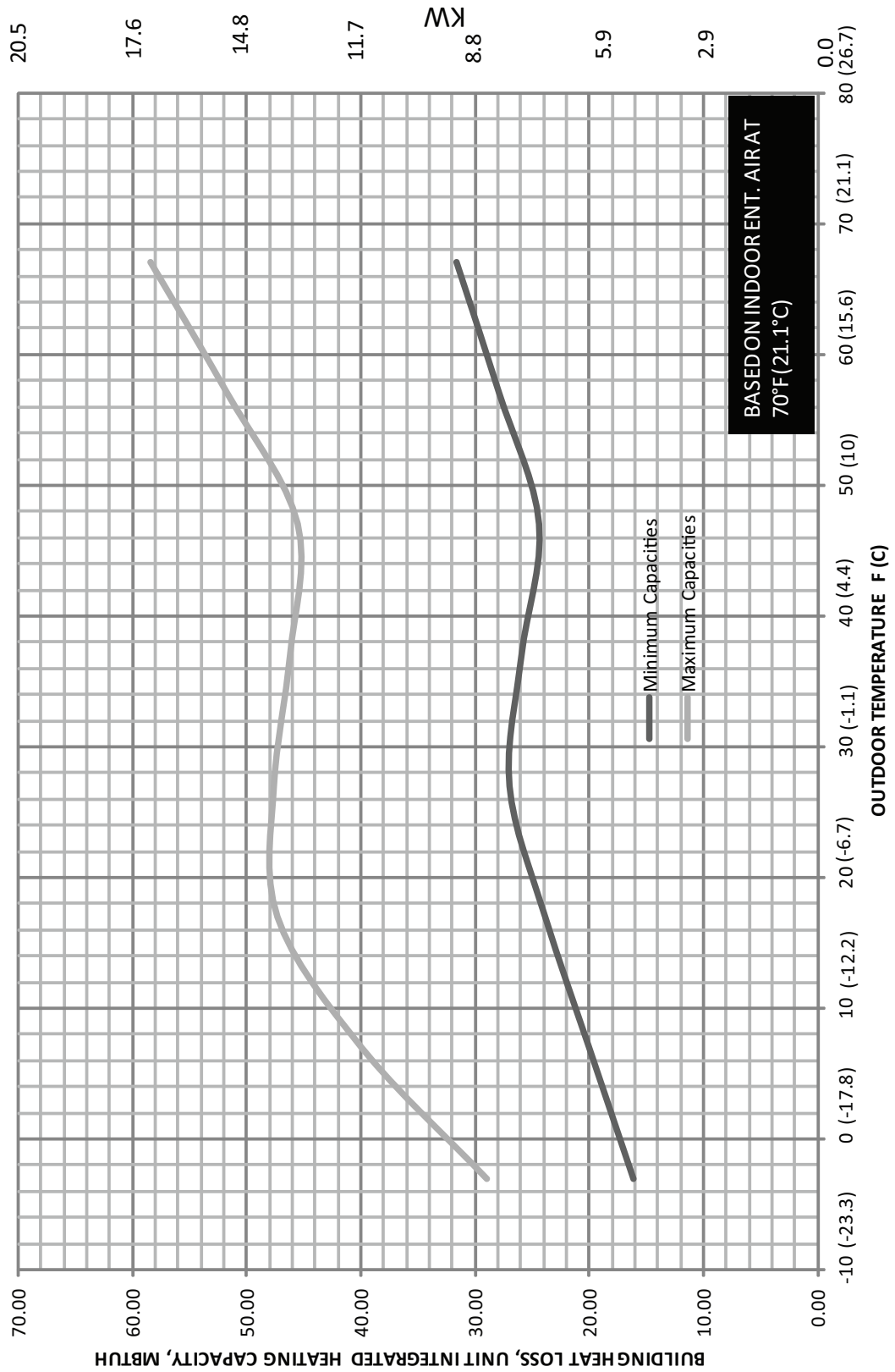

25VNA BALANCE POINT WORKSHEET CONT.

25VNA060 BALANCE POINT WORK SHEET
 MINIMUM AND MAXIMUM HEATING CAPACITIES

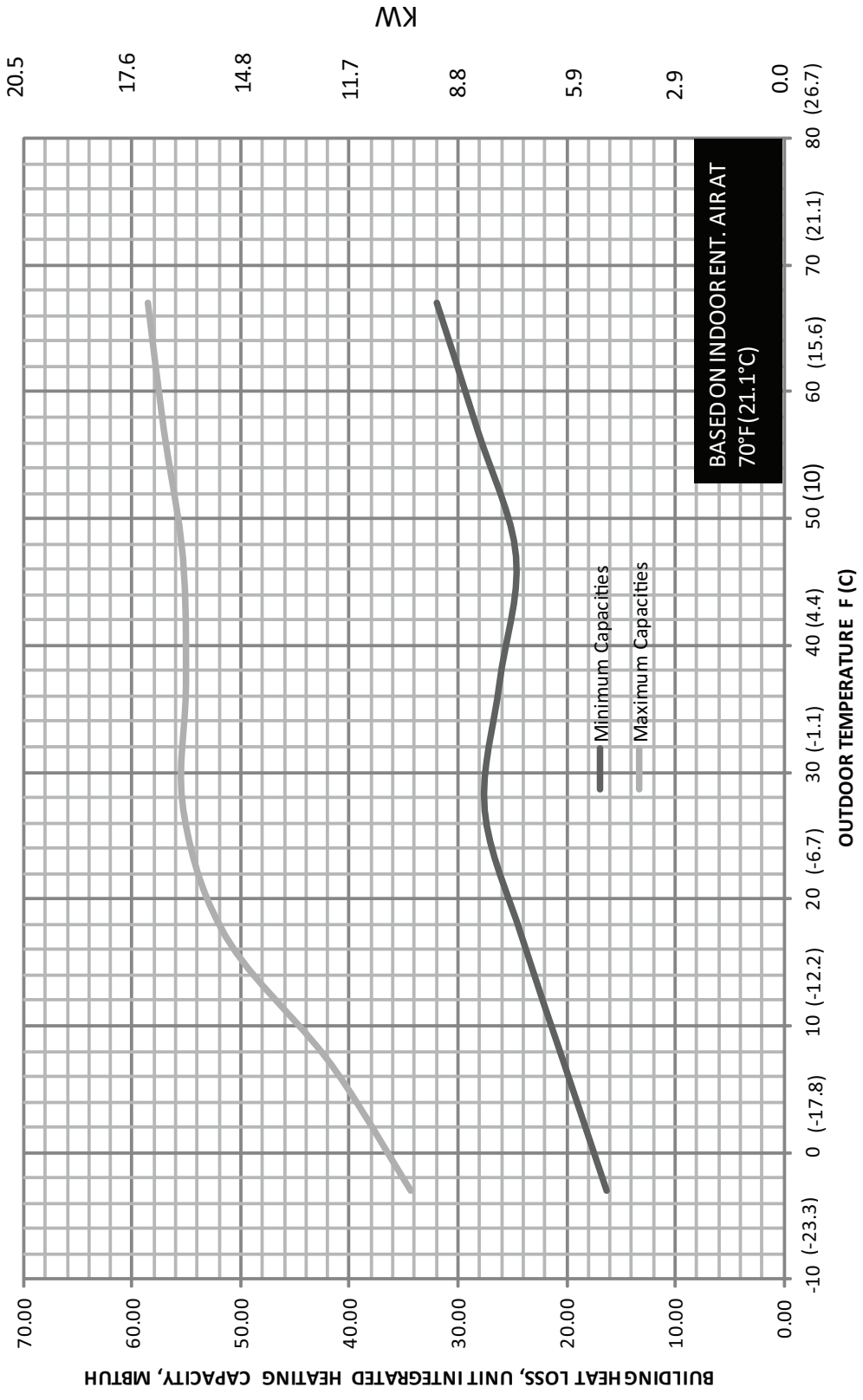

CLEARANCES

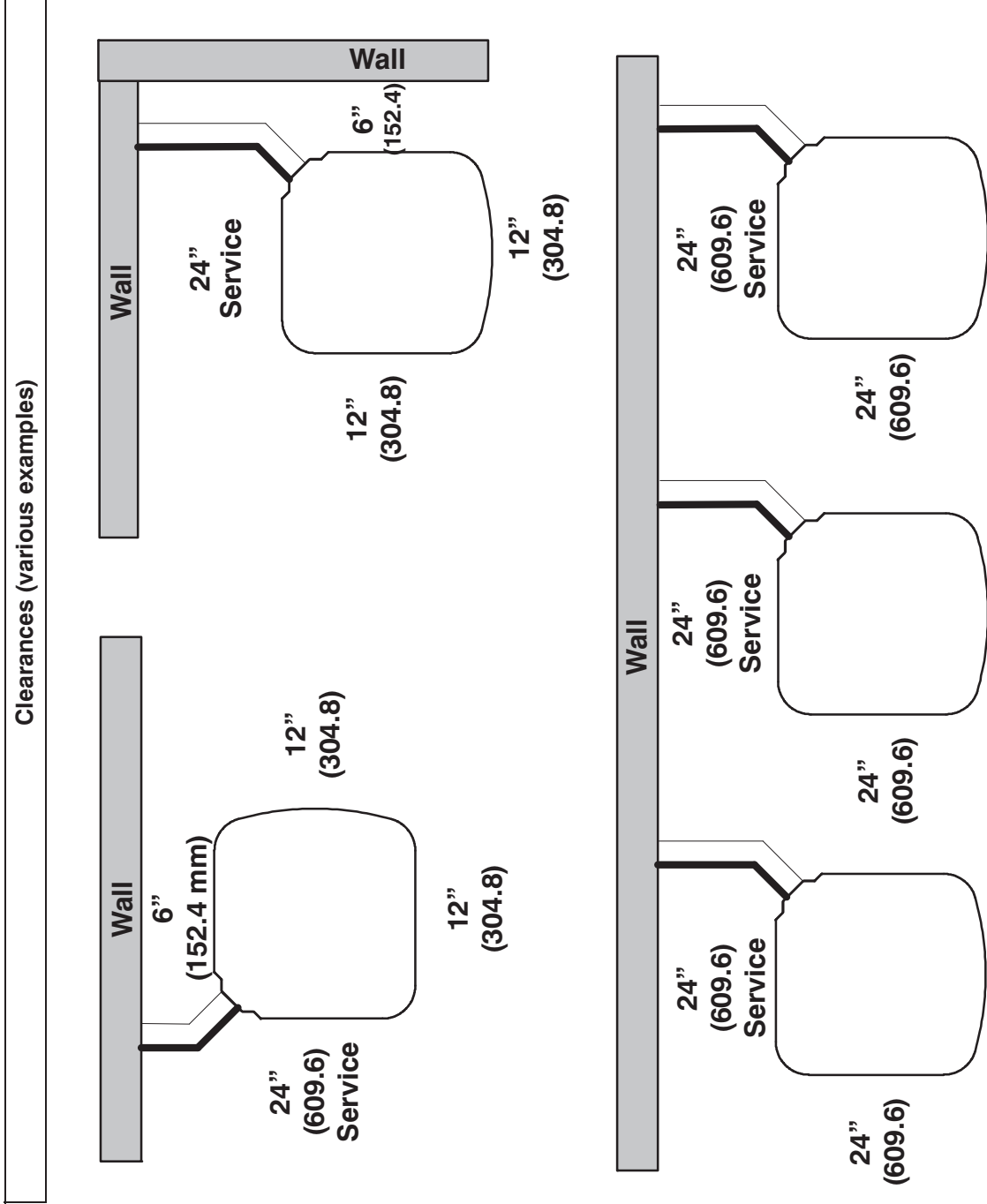

Note: Numbers in () = mm

IMPORTANT: When installing multiple units in an alcove, roof well, or partially enclosed area, ensure there is adequate ventilation to prevent re-circulation of discharge air.

TESTED AHRI COMBINATION RATINGS*

NOTE: Ratings contained in this document are subject to change at any time.

For AHRI ratings certificates, please refer to the AHRI directory www.ahridirectory.org
 Additional ratings and system combinations can be accessed via the Carrier database at: http://cactaxcredits.info/carrier-ratings/ac_ratings_srch.php
 Equipment performance calculator can be accessed at: <http://rpmob.wrightsoft.com/>

Model Number	Coil Model Number	Furnace Model Number	Clg. Cap. High	Clg. Cap. Low	EER	SEER	ID CFM		High Temp		HSPF	Low Temp	
							High	Low	E Capacity	E COP		H Capacity	H COP
25VNA024A**30	FE4ANB006+UI		25,200	19,200	16.0	20.5	900	650	23,600	4.70	13.0	24,800	2.54
25VNA036A**30	FE4ANB006+UI		35,000	23,200	14.5	20.5	1200	875	33,400	4.40	13.0	31,600	2.54
25VNA048A**30	FE4ANB006+UI		47,500	34,800	13.5	18.3	1500	1100	45,500	4.12	12.5	47,500	2.22
25VNA060A**30	FE4ANB006+UI		56,000	38,000	12.7	18.0	1500	1100	55,500	3.86	12.0	52,500	2.22

* Ratings are net values reflecting the effects of circulating fan heat. Supplemental electric heat is not included. Ratings are based on:

- Cooling Standard:** 80°F (27°C) db 67°F (19°C) wb indoor entering air temperature and 95°F (35°C) db air entering outdoor unit.
- High-Temp Heating Standard:** 70°F (21°C) db indoor entering air temperature and 47°F (8°C) db 43°F (6°C) wb air entering outdoor unit.
- Low-Temp Heating Standard:** 70°F (21°C) db indoor entering air temperature and 17°F (-8°C) db 15°F (-9°C) wb air entering outdoor unit.
- COP** — Coefficient of Performance
- EER** — Energy Efficiency Ratio
- HSPF** — Heating Seasonal Performance Factor
- SEER** — Seasonal Energy Efficiency Ratio
- UI** — User Interface

DETAILED COOLING CAPACITIES#

Table with columns for EVAP AIR, 75 (23.9), 85 (29.4), 95 (35), 105 (40.6), 115 (46.1), 125 (51.7) and rows for various indoor air temperatures from 57°F to 72°F.

Table with columns for EVAP AIR, 75 (23.9), 85 (29.4), 95 (35), 105 (40.6), 115 (46.1), 125 (51.7) and rows for various indoor air temperatures from 57°F to 72°F.

Table with columns for COOLING INDOOR MODEL, CAPACITY, POWER, FURNACE MODEL and rows for various cooling models like CAP**4821A** and CNPH*3617A**.

DETAILED COOLING CAPACITIES# CONTINUED

25VNA024A**30 Outdoor Section With FE4ANB006 Indoor Section

COOLING INDOOR MODEL	CAPACITY	POWER	FURNACE MODEL
CNPV*4324A**	0.99	1.02	58MV/B040-14
CNPV*4824A**	0.98	1.04	58MV/B040-14
CNPV*6024A**	0.98	1.03	58MV/B040-14
CNPV*6124A**	1.00	1.03	58MV/B040-14
CSPH*3612A**	0.98	1.04	58MV/B040-14
CSPH*4212A**	0.98	1.04	58MV/B040-14
CSPH*4812A**	0.98	1.04	58MV/B040-14
CAP**4324A**	0.99	1.04	58MV/B040-14
CAP**4817A**	0.96	1.05	59*N*A080V17**14
CAP**3621A**	0.96	1.04	59*N*A080V17**14
CAP**4212A**	0.96	1.03	59*N*A080V17**14
CAP**4817A**	0.98	1.03	59*N*A080V17**14
CAP**6021A**	0.98	1.03	59*N*A080V17**14
CNPV*3617A**	0.96	1.04	59*N*A080V17**14
CNPV*4212A**	0.98	1.04	59*N*A080V17**14
CNPV*4812A**	0.98	1.03	59*N*A080V17**14
CNPV*6012A**	0.98	1.03	59*N*A080V17**14
CNPV*6124A**	0.98	1.03	59*N*A080V17**14
CNPV*6212A**	0.98	1.03	59*N*A080V17**14
CSPH*3612A**	0.98	1.03	59*N*A080V17**14
CSPH*4212A**	0.98	1.03	59*N*A080V17**14
CSPH*4812A**	0.98	1.03	59*N*A080V17**14
CSPH*6012A**	0.98	1.04	59*N*A080V17**14
CSPH*6124A**	0.98	1.04	59*N*A080V17**14
CSPH*6212A**	0.98	1.04	59*N*A080V17**14
CAP**3617A**	0.96	1.05	59*N*A080V17**14
CAP**4212A**	0.96	1.05	59*N*A080V17**14
CAP**4817A**	0.98	1.03	59*N*A080V17**14
CAP**6012A**	0.98	1.04	59*N*A080V17**14
CNPV*4212A**	0.98	1.04	59*N*A080V17**14
CNPV*4812A**	0.98	1.03	59*N*A080V17**14
CNPV*6012A**	0.98	1.04	59*N*A080V17**14
CNPV*6124A**	0.98	1.04	59*N*A080V17**14
CNPV*6212A**	0.98	1.04	59*N*A080V17**14

COOLING INDOOR MODEL	CAPACITY	POWER	FURNACE MODEL
CAP**4212A**	0.96	1.04	59*N*A080V21**20
CAP**4224A**	0.96	1.04	59*N*A080V21**20
CAP**4821A**	0.97	1.03	59*N*A080V21**20
CAP**4824A**	0.97	1.03	59*N*A080V21**20
CAP**6021A**	0.98	1.04	59*N*A080V21**20
CAP**6024A**	0.98	1.04	59*N*A080V21**20
CNPV*4212A**	0.97	1.05	59*N*A080V21**20
CNPV*4821A**	0.98	1.03	59*N*A080V21**20
CNPV*4824A**	0.98	1.03	59*N*A080V21**20
CNPV*6021A**	0.98	1.03	59*N*A080V21**20
CNPV*6024A**	0.97	1.05	59*N*A080V21**20
CNPV*6212A**	0.96	1.04	59*N*A080V21**20
CNPV*6224A**	0.97	1.04	59*N*A080V21**20
CSPH*3612A**	0.98	1.04	59*N*A080V21**20
CSPH*4212A**	0.98	1.04	59*N*A080V21**20
CSPH*4812A**	0.98	1.04	59*N*A080V21**20
CSPH*6012A**	0.98	1.04	59*N*A080V21**20
CSPH*6124A**	0.96	1.05	59*N*A080V21**20
CSPH*6212A**	0.97	1.05	59*N*A080V21**20
CAP**4212A**	0.96	1.05	59*N*A080V21**20
CAP**4224A**	0.96	1.05	59*N*A080V21**20
CAP**4821A**	0.97	1.03	59*N*A080V21**20
CAP**4824A**	0.98	1.03	59*N*A080V21**20
CAP**6021A**	0.98	1.04	59*N*A080V21**20
CAP**6024A**	0.98	1.04	59*N*A080V21**20
CNPV*3617A**	0.96	1.06	59*N*A100V21**20
CNPV*4212A**	0.97	1.05	59*N*A100V21**20
CNPV*4821A**	0.99	1.03	59*N*A100V21**20
CNPV*4824A**	0.98	1.03	59*N*A100V21**20
CNPV*6021A**	0.98	1.04	59*N*A100V21**20
CNPV*6024A**	0.98	1.04	59*N*A100V21**20
CNPV*6124A**	0.98	1.04	59*N*A100V21**20
CNPV*6212A**	0.96	1.06	59*N*A100V21**20
CNPV*6224A**	0.97	1.05	59*N*A100V21**20
CSPH*4212A**	0.98	1.04	59*N*A100V21**20
CSPH*4821A**	0.98	1.04	59*N*A100V21**20
CSPH*6012A**	0.98	1.04	59*N*A100V21**20
CSPH*6124A**	0.96	1.05	59*N*A100V21**20
CSPH*6212A**	0.97	1.05	59*N*A100V21**20
CAP**4212A**	0.96	1.05	59*N*A100V21**20
CAP**4224A**	0.96	1.05	59*N*A100V21**20
CAP**4821A**	0.97	1.03	59*N*A100V21**20
CAP**4824A**	0.98	1.03	59*N*A100V21**20
CAP**6021A**	0.98	1.04	59*N*A100V21**20
CAP**6024A**	0.98	1.04	59*N*A100V21**20
CNPV*4212A**	0.96	1.06	59*N*A100V21**20
CNPV*4821A**	0.97	1.05	59*N*A100V21**20
CNPV*4824A**	0.97	1.05	59*N*A100V21**20
CNPV*6021A**	0.98	1.04	59*N*A100V21**20
CNPV*6024A**	0.98	1.04	59*N*A100V21**20
CNPV*6124A**	0.98	1.04	59*N*A100V21**20
CNPV*6212A**	0.96	1.06	59*N*A100V21**20
CNPV*6224A**	0.97	1.05	59*N*A100V21**20
CSPH*4212A**	0.98	1.04	59*N*A100V21**20
CSPH*4821A**	0.98	1.04	59*N*A100V21**20
CSPH*6021A**	0.98	1.04	59*N*A100V21**20
CSPH*6024A**	0.98	1.04	59*N*A100V21**20
CSPH*6124A**	0.96	1.05	59*N*A100V21**20
CSPH*6212A**	0.97	1.05	59*N*A100V21**20
CAP**3621A**	0.96	1.05	59*N*A100V21**20
CNPV*4212A**	0.97	1.05	59*N*A100V21**20

COOLING INDOOR MODEL	CAPACITY	POWER	FURNACE MODEL
CNPV*4824A**	0.98	1.03	59*N*A100V21**20
CNPV*6024A**	0.98	1.03	59*N*A100V21**20
CSPH*3612A**	0.98	1.03	59*N*A100V21**20
CSPH*4212A**	0.98	1.04	59*N*A100V21**20
CSPH*4812A**	0.98	1.04	59*N*A100V21**20
CSPH*6012A**	0.99	1.04	59*N*A100V21**20
CSPH*6124A**	0.98	1.04	59*N*A100V21**20
CSPH*6212A**	0.97	1.05	59*N*A100V21**20
CAP**4212A**	0.97	1.03	59*N*A100V21**20
CAP**4224A**	0.98	1.03	59*N*A100V21**20
CAP**4821A**	0.98	1.03	59*N*A100V21**20
CAP**4824A**	0.98	1.03	59*N*A100V21**20
CAP**6021A**	0.98	1.03	59*N*A100V21**20
CAP**6024A**	0.98	1.04	59*N*A100V21**20
CNPV*4212A**	0.98	1.04	59*N*A100V21**20
CNPV*4821A**	0.98	1.04	59*N*A100V21**20
CNPV*4824A**	0.98	1.04	59*N*A100V21**20
CNPV*6021A**	0.98	1.04	59*N*A100V21**20
CNPV*6024A**	0.98	1.04	59*N*A100V21**20
CNPV*6124A**	1.00	1.01	59*N*A100V21**20
CNPV*6212A**	0.98	1.01	59*N*A100V21**20
CNPV*6224A**	0.98	1.01	59*N*A100V21**20
CSPH*3612A**	0.98	1.03	59*N*A100V21**20
CSPH*4212A**	0.98	1.03	59*N*A100V21**20
CSPH*4812A**	0.98	1.02	59*N*A100V21**20
CSPH*6012A**	0.99	1.02	59*N*A100V21**20
CSPH*6124A**	0.98	1.02	59*N*A100V21**20
CSPH*6212A**	0.98	1.02	59*N*A100V21**20
CAP**4212A**	0.96	1.05	59MN/A060V21**20
CAP**4224A**	0.96	1.05	59MN/A060V21**20
CAP**4821A**	0.97	1.03	59MN/A060V21**20
CAP**4824A**	0.97	1.03	59MN/A060V21**20
CAP**6021A**	0.98	1.03	59MN/A060V21**20
CAP**6024A**	0.98	1.04	59MN/A060V21**20
CNPV*4212A**	0.98	1.04	59MN/A060V21**20
CNPV*4821A**	0.98	1.04	59MN/A060V21**20
CNPV*4824A**	0.98	1.04	59MN/A060V21**20
CNPV*6021A**	0.98	1.04	59MN/A060V21**20
CNPV*6024A**	0.98	1.04	59MN/A060V21**20
CNPV*6124A**	0.98	1.04	59MN/A060V21**20
CNPV*6212A**	0.98	1.06	59MN/A060V21**20
CNPV*6224A**	0.98	1.06	59MN/A060V21**20
CSPH*4212A**	0.98	1.04	59MN/A060V21**20
CSPH*4821A**	0.98	1.04	59MN/A060V21**20
CSPH*6012A**	0.98	1.05	59MN/A060V21**20
CSPH*6124A**	0.98	1.05	59MN/A060V21**20
CSPH*6212A**	0.98	1.05	59MN/A060V21**20

See notes on page 24

DETAILED COOLING CAPACITIES# CONTINUED

EVAP AIR		CONDENSER ENTERING AIR TEMPERATURES ° F (° C)																				
		75 (23.9)			85 (29.4)			95 (35)			105 (40.6)			115 (46.1)			125 (51.7)					
		ID SCFM	Capacity MBtuh	Total Sys. KW	ID SCFM	Capacity MBtuh	Total Sys. KW	ID SCFM	Capacity MBtuh	Total Sys. KW	ID SCFM	Capacity MBtuh	Total Sys. KW	ID SCFM	Capacity MBtuh	Total Sys. KW	ID SCFM	Capacity MBtuh	Total Sys. KW			
EWB °F (°C)																						
57 (13.9)		35.99	1.83	34.03	34.03	2.12		32.35	32.35	2.46		30.32	30.32	2.83		28.15	28.15	3.25		25.40	25.40	3.71
62 (16.7)		36.04	1.83	34.09	34.09	2.12		32.40	32.40	2.46		30.37	30.37	2.83		28.19	28.19	3.25		25.44	25.44	3.70
63 (17.2)††	1325	36.10	1.83	34.19	27.82	2.12	1200	32.33	26.63	2.46	1120	30.31	24.97	2.83	1035	28.14	23.19	3.25	900	25.62	20.72	3.70
67 (19.4)		39.00	1.79	36.98	29.12	2.07		35.00	27.90	2.41		32.86	26.18	2.79		30.58	24.34	3.20		27.90	21.76	3.65
72 (22.2)		43.06	1.74	40.86	23.02	2.02		38.71	22.00	2.36		36.41	20.68	2.72		33.96	19.27	3.13		31.07	17.37	3.58

25VNA036A**30 Outdoor Section With FE4ANB006 Indoor Section - Maximum

EVAP AIR		CONDENSER ENTERING AIR TEMPERATURES ° F (° C)																					
		75 (23.9)			85 (29.4)			95 (35)			105 (40.6)			115 (46.1)			125 (51.7)						
		ID SCFM	Capacity MBtuh	Total Sys. KW	ID SCFM	Capacity MBtuh	Total Sys. KW	ID SCFM	Capacity MBtuh	Total Sys. KW	ID SCFM	Capacity MBtuh	Total Sys. KW	ID SCFM	Capacity MBtuh	Total Sys. KW	ID SCFM	Capacity MBtuh	Total Sys. KW				
EWB °F (°C)																							
57 (13.9)		14.31	14.31	0.60	13.73	13.73	0.74		13.07	13.07	0.89		15.18	15.18	1.45		16.65	16.65	2.20		16.69	16.69	2.78
62 (16.7)		14.31	14.31	0.60	13.75	13.75	0.74		13.11	13.11	0.89		15.27	15.14	1.45		17.16	16.03	2.18		17.22	16.05	2.77
63 (17.2)††	500	14.40	11.66	0.60	13.68	11.34	0.74	500	12.89	11.01	0.90	500	15.56	12.16	1.44	500	17.55	13.04	2.17	500	17.62	13.07	2.76
67 (19.4)		15.61	12.20	0.57	14.82	11.88	0.71		13.97	11.56	0.87		16.92	12.73	1.41		19.12	13.64	2.13		19.24	13.69	2.72
72 (22.2)		17.18	9.66	0.53	16.40	9.88	0.87		15.48	9.05	0.83		18.82	10.26	1.35		21.36	11.22	2.07		21.55	11.30	2.65

25VNA036A**30 Outdoor Section With FE4ANB006 Indoor Section - Minimum

COOLING INDOOR MODEL		CAPACITY			POWER			FURNACE MODEL		
		Capacity	Power	Furnace	Capacity	Power	Furnace	Capacity	Power	Furnace
		MBtuh	KW	Model	MBtuh	KW	Model	MBtuh	KW	Model
*FE4ANB006	1.00	1.00	58CV(A,X)090-16	0.97	1.07	58CV(A,X)090-16	0.99	1.05	58CV(A,X)110-20	
FE4AN(B,F)003	0.95	1.05	58CV(A,X)090-16	0.98	1.06	58CV(A,X)090-16	0.99	1.05	58CV(A,X)110-20	
FE4AN(B,F)005	1.00	1.04	58CV(A,X)090-16	0.95	1.06	58CV(A,X)090-16	0.95	1.06	58CV(A,X)110-20	
FE4ANF002	0.95	1.08	58CV(A,X)090-16	0.96	1.05	58CV(A,X)090-16	0.96	1.05	58CV(A,X)110-20	
CAP**3614A**	0.94	1.09	58CV(A,X)070-12	0.99	1.05	58CV(A,X)090-16	0.99	1.05	58CV(A,X)110-20	
CAP**3617A**	0.95	1.10	58CV(A,X)070-12	0.98	1.05	58CV(A,X)090-16	0.98	1.05	58CV(A,X)110-20	
CAP**4817A**	0.97	1.08	58CV(A,X)070-12	0.99	1.05	58CV(A,X)090-16	1.00	1.06	58CV(A,X)110-20	
CNP**3617A**	0.94	1.09	58CV(A,X)070-12	1.00	1.06	58CV(A,X)090-16	1.00	1.06	58CV(A,X)110-20	
CNP**4221A**	0.95	1.09	58CV(A,X)070-12	0.95	1.06	58CV(A,X)090-16	0.95	1.06	58CV(A,X)110-20	
CNP**4321A**	0.98	1.08	58CV(A,X)070-12	0.95	1.06	58CV(A,X)090-16	0.96	1.05	58CV(A,X)110-20	
CNP**4821A**	0.97	1.08	58CV(A,X)070-12	0.99	1.06	58CV(A,X)090-16	0.99	1.05	58CV(A,X)110-20	
CNP**6024A**	0.99	1.09	58CV(A,X)070-12	0.97	1.06	58CV(A,X)090-16	0.98	1.05	58CV(A,X)110-20	
CNP**6124A**	0.99	1.09	58CV(A,X)070-12	0.96	1.05	58CV(A,X)090-16	0.98	1.05	58CV(A,X)110-20	
CNP**3617A**	0.94	1.09	58CV(A,X)070-12	0.98	1.05	58CV(A,X)090-16	1.01	1.03	58CV(A,X)110-20	
CNP**3717A**	0.98	1.10	58CV(A,X)070-12	0.97	1.07	58CV(A,X)090-16	0.97	1.07	58CV(A,X)110-20	
CNP**4217A**	0.96	1.10	58CV(A,X)070-12	0.98	1.05	58CV(A,X)090-16	0.98	1.06	58CV(A,X)110-20	
CSPH**3612A**	0.97	1.08	58CV(A,X)070-12	0.98	1.06	58CV(A,X)090-16	0.98	1.06	58CV(A,X)110-20	
CSPH**4212A**	0.97	1.08	58CV(A,X)070-12	1.00	1.06	58CV(A,X)090-16	1.01	1.04	58CV(A,X)110-20	
CSPH**4812A**	0.98	1.09	58CV(A,X)070-12	0.95	1.05	58CV(A,X)110-20	0.97	1.04	58CV(A,X)135-22	
CSPH**6012A**	0.99	1.09	58CV(A,X)070-12	0.96	1.05	58CV(A,X)110-20	0.98	1.03	58CV(A,X)135-22	
CAP**3617A**	0.95	1.06	58CV(A,X)090-16	0.96	1.05	58CV(A,X)110-20	0.99	1.05	58CV(A,X)135-22	
CAP**3619A**	0.95	1.06	58CV(A,X)090-16	0.98	1.05	58CV(A,X)110-20	0.99	1.05	58CV(A,X)135-22	
CAP**3621A**	0.95	1.05	58CV(A,X)090-16	0.98	1.05	58CV(A,X)110-20	0.95	1.06	58CV(A,X)135-22	
CAP**4221A**	0.96	1.05	58CV(A,X)090-16	0.98	1.05	58CV(A,X)110-20	0.97	1.06	58CV(A,X)135-22	
CAP**4817A**	0.98	1.05	58CV(A,X)090-16	0.98	1.04	58CV(A,X)110-20	0.99	1.03	58CV(A,X)135-22	

25VNA

DETAILED COOLING CAPACITIES# CONTINUED

25VNA036A**30 Outdoor Section With FE4ANB006 Indoor Section

COOLING INDOOR MODEL	CAPACITY	POWER	FURNACE MODEL
CAP**4221A**	0.95	1.11	59*N*A060V17**14
CAP**4817A**	0.97	1.11	59*N*A060V17**14
CAP**4821A**	0.96	1.10	59*N*A060V17**14
CAP**6021A**	0.97	1.10	59*N*A060V17**14
CNPH**3617A**	0.94	1.13	59*N*A060V17**14
CNPH**4221A**	0.95	1.12	59*N*A060V17**14
CNPH**4321A**	0.98	1.10	59*N*A060V17**14
CNPH**4821A**	0.97	1.10	59*N*A060V17**14
CNPH**6024A**	0.98	1.10	59*N*A060V17**14
CNPH**6124A**	0.99	1.10	59*N*A060V17**14
CNPH**3617A**	0.94	1.11	59*N*A060V17**14
CNPH**4221A**	0.94	1.13	59*N*A060V17**14
CNPH**4821A**	0.94	1.13	59*N*A060V17**14
CNPH**3717A**	0.98	1.12	59*N*A060V17**14
CNPH**4217A**	0.95	1.12	59*N*A060V17**14
CNPH**4221A**	0.95	1.12	59*N*A060V17**14
CNPH**4821A**	0.97	1.10	59*N*A060V17**14
CSPH**3612A**	0.96	1.11	59*N*A060V17**14
CSPH**4221A**	0.97	1.11	59*N*A060V17**14
CSPH**4812A**	0.97	1.11	59*N*A060V17**14
CSPH**6012A**	0.99	1.09	59*N*A060V17**14
CAP**3617A**	0.94	1.09	59*N*A060V17**14
CAP**3619A**	0.94	1.11	59*N*A060V17**14
CAP**3821A**	0.95	1.08	59*N*A060V17**14
CAP**4221A**	0.95	1.08	59*N*A060V17**14
CAP**4817A**	0.97	1.08	59*N*A060V17**14
CAP**4821A**	0.97	1.09	59*N*A060V17**14
CAP**6021A**	0.98	1.07	59*N*A060V17**14
CNPH**3617A**	0.94	1.10	59*N*A060V17**14
CNPH**4221A**	0.95	1.09	59*N*A060V17**14
CNPH**4821A**	0.98	1.08	59*N*A060V17**14
CNPH**4321A**	0.97	1.08	59*N*A060V17**14
CNPH**6024A**	0.99	1.09	59*N*A060V17**14
CNPH**6124A**	0.99	1.09	59*N*A060V17**14
CNPH**3617A**	0.94	1.12	59*N*A060V17**14
CNPH**3821A**	0.94	1.10	59*N*A060V17**14
CNPH**3717A**	0.98	1.09	59*N*A060V17**14
CNPH**4217A**	0.96	1.11	59*N*A060V17**14
CNPH**4221A**	0.95	1.09	59*N*A060V17**14
CNPH**4812A**	0.95	1.09	59*N*A060V17**14
CNPH**4821A**	0.97	1.08	59*N*A060V17**14
CSPH**3612A**	0.97	1.09	59*N*A060V17**14
CSPH**4212A**	0.98	1.08	59*N*A060V17**14
CSPH**6012A**	0.99	1.09	59*N*A060V17**14
CAP**4221A**	0.96	1.06	59*N*A060V17**14
CAP**4821A**	0.97	1.07	59*N*A060V17**14
CAP**6024A**	0.98	1.06	59*N*A060V17**14
CNPH**4821A**	0.97	1.07	59*N*A060V17**14
CNPH**6024A**	0.99	1.06	59*N*A060V17**14
CNPH**4212A**	0.99	1.08	59*N*A060V17**14
CNPH**4812A**	0.99	1.08	59*N*A060V17**14
CSPH**4812A**	0.96	1.07	59*N*A060V17**14
CAP**4821A**	0.96	1.05	59*N*A060V17**14
CAP**6024A**	0.99	1.07	59*N*A060V17**14
CNPH**4221A**	0.95	1.06	59*N*A060V17**14

COOLING INDOOR MODEL	CAPACITY	POWER	FURNACE MODEL
CNPH**4821A**	0.97	1.06	59*N*A060V21**20
CNPH**4824A**	0.97	1.07	59*N*A060V21**20
CNPH**6024A**	0.99	1.07	59*N*A060V21**20
CSPH**3612A**	0.95	1.06	59*N*A060V21**20
CSPH**4212A**	0.95	1.06	59*N*A060V21**20
CSPH**4812A**	0.98	1.07	59*N*A060V21**20
CSPH**6012A**	0.99	1.07	59*N*A060V21**20
CAP**4221A**	0.95	1.06	59*N*A100V21**20
CAP**4824A**	0.96	1.06	59*N*A100V21**20
CAP**6025A**	0.96	1.07	59*N*A100V21**20
CNPH**3617A**	0.94	1.08	59*N*A100V21**20
CNPH**4221A**	0.96	1.07	59*N*A100V21**20
CNPH**4321A**	0.99	1.06	59*N*A100V21**20
CNPH**4821A**	0.98	1.07	59*N*A100V21**20
CNPH**6024A**	0.99	1.07	59*N*A100V21**20
CNPH**6124A**	0.99	1.07	59*N*A100V21**20
CNPH**3821A**	0.95	1.08	59*N*A100V21**20
CNPH**4221A**	0.96	1.07	59*N*A100V21**20
CNPH**4321A**	0.99	1.06	59*N*A100V21**20
CNPH**4821A**	0.98	1.07	59*N*A100V21**20
CNPH**6024A**	0.99	1.07	59*N*A100V21**20
CNPH**6124A**	0.99	1.07	59*N*A100V21**20
CSPH**3612A**	0.96	1.07	59*N*A100V21**20
CSPH**4212A**	0.96	1.07	59*N*A100V21**20
CSPH**4812A**	0.98	1.07	59*N*A100V21**20
CSPH**6012A**	1.00	1.06	59*N*A100V21**20
CAP**3621A**	0.95	1.06	59*N*A100V21**22
CAP**4221A**	0.96	1.06	59*N*A100V21**22
CAP**4224A**	0.96	1.06	59*N*A100V21**22
CAP**4821A**	0.97	1.06	59*N*A100V21**22
CAP**4824A**	0.97	1.06	59*N*A100V21**22
CAP**6021A**	0.99	1.07	59*N*A100V21**22
CAP**6024A**	0.99	1.07	59*N*A100V21**22
CNPH**4221A**	0.96	1.07	59*N*A100V21**22
CNPH**4821A**	0.98	1.07	59*N*A100V21**22
CNPH**4221A**	0.96	1.07	59*N*A100V21**22
CNPH**4821A**	0.96	1.07	59*N*A100V21**22
CNPH**4812A**	0.98	1.07	59*N*A100V21**22
CNPH**6012A**	0.99	1.06	59*N*A100V21**22
CNPH**6024A**	0.99	1.07	59*N*A100V21**22
CNPH**3612A**	0.95	1.06	59*N*A100V21**22
CNPH**4212A**	0.96	1.06	59*N*A100V21**22
CNPH**4812A**	0.98	1.07	59*N*A100V21**22
CSPH**6012A**	0.99	1.07	59*N*A100V21**22
CAP**4821A**	0.96	1.05	59*N*A120V24**22
CAP**4224A**	0.98	1.05	59*N*A120V24**22
CAP**6024A**	0.98	1.06	59*N*A120V24**22

COOLING INDOOR MODEL	CAPACITY	POWER	FURNACE MODEL
CAP**6025A**	0.98	1.06	59*N*A120V24**22
CNPH**3617A**	0.95	1.07	59*N*A120V24**22
CNPH**4221A**	0.96	1.07	59*N*A120V24**22
CNPH**4321A**	0.99	1.05	59*N*A120V24**22
CNPH**4821A**	0.95	1.05	59*N*A120V24**22
CNPH**6024A**	1.00	1.06	59*N*A120V24**22
CNPH**6124A**	1.00	1.06	59*N*A120V24**22
CNPH**4824A**	0.99	1.05	59*N*A120V24**22
CNPH**4824A**	0.98	1.05	59*N*A120V24**22
CNPH**6024A**	1.00	1.06	59*N*A120V24**22
CNPH**6124A**	1.00	1.06	59*N*A120V24**22
CNPH**4824A**	0.98	1.05	59*N*A120V24**22
CAP**3621A**	0.95	1.09	59MN7A060V21**20
CAP**4221A**	0.95	1.08	59MN7A060V21**20
CAP**4224A**	0.95	1.08	59MN7A060V21**20
CAP**4821A**	0.95	1.08	59MN7A060V21**20
CAP**4824A**	0.97	1.08	59MN7A060V21**20
CAP**6021A**	0.97	1.08	59MN7A060V21**20
CAP**6024A**	0.99	1.09	59MN7A060V21**20
CNPH**4221A**	0.95	1.09	59MN7A060V21**20
CNPH**4821A**	0.97	1.11	59MN7A060V21**20
CNPH**6024A**	0.99	1.08	59MN7A060V21**20
CNPH**4221A**	0.99	1.09	59MN7A060V21**20
CNPH**4821A**	0.95	1.09	59MN7A060V21**20
CNPH**4824A**	0.97	1.08	59MN7A060V21**20
CNPH**6024A**	0.97	1.08	59MN7A060V21**20
CNPH**6124A**	0.99	1.08	59MN7A060V21**20
CSPH**4221A**	0.99	1.07	59MN7A060V21**20
CSPH**4812A**	0.99	1.07	59MN7A060V21**20
CSPH**6012A**	0.98	1.06	59MN7A060V21**20
CSPH**6024A**	0.98	1.06	59MN7A060V21**20
CSPH**6024A**	0.98	1.06	59MN7A060V21**20
CSPH**6024A**	0.98	1.06	59MN7A060V21**20
CSPH**6024A**	0.98	1.06	59MN7A060V21**20
CSPH**6024A**	0.98	1.06	59MN7A060V21**20
CSPH**6024A**	0.98	1.06	59MN7A060V21**20
CSPH**6024A**	0.98	1.06	59MN7A060V21**20
CSPH**6024A**	0.98	1.06	59MN7A060V21**20
CSPH**6024A**	0.98	1.06	59MN7A060V21**20

See notes on page 24

DETAILED COOLING CAPACITIES# CONTINUED

25VNA048A**30 Outdoor Section With FE4ANB006 Indoor Section – Maximum

COOLING INDOOR MODEL	CAPACITY	POWER	FURNACE MODEL
CNPH*6124A**	0.98	1.04	59*N*A120V24**22
CNPH*4824A**	0.96	1.03	59*N*A120V24**22
CNPH*6024A**	0.98	1.03	59*N*A120V24**22
CNPH*6124A**	0.99	1.04	59*N*A120V24**22
CSPH*4812A**	0.96	1.03	59*N*A120V24**22
CSPH*6012A**	0.98	1.03	59*N*A120V24**22
CAP**4821A**	0.95	1.06	59MN7A060V21**20
CAP**4824A**	0.95	1.06	59MN7A060V21**20
CAP**6021A**	0.97	1.09	59MN7A060V21**20
CAP**6024A**	0.97	1.06	59MN7A060V21**20
CNPH*4821A**	0.95	1.06	59MN7A060V21**20
CNPH*6024A**	0.97	1.09	59MN7A060V21**20
CNPH*4821A**	0.95	1.06	59MN7A060V21**20
CNPH*4824A**	0.95	1.08	59MN7A060V21**20
CNPH*6024A**	0.97	1.09	59MN7A060V21**20
CSPH*4812A**	0.95	1.06	59MN7A060V21**20
CSPH*6012A**	0.97	1.06	59MN7A060V21**20
CAP**4821A**	0.95	1.07	58MV(B,C)080-20
CAP**4823A**	0.95	1.07	58MV(B,C)080-20
CAP**4824A**	0.95	1.06	58MV(B,C)080-20
CAP**6021A**	0.97	1.06	58MV(B,C)080-20
CAP**6024A**	0.97	1.05	58MV(B,C)080-20
CAP**6025A**	0.95	1.06	58MV(B,C)080-20
CNPH*4821A**	0.95	1.06	58MV(B,C)080-20
CNPH*6024A**	0.97	1.05	58MV(B,C)080-20
CNPH*6124A**	0.97	1.05	58MV(B,C)080-20
CSPH*4812A**	0.96	1.07	58MV(B,C)080-20
CSPH*6012A**	0.97	1.05	58MV(B,C)080-20
CAP**4821A**	0.95	1.06	58MV(B,C)100-20
CAP**4823A**	0.95	1.06	58MV(B,C)100-20
CAP**4824A**	0.95	1.05	58MV(B,C)100-20
CAP**6021A**	0.97	1.05	58MV(B,C)100-20
CAP**6024A**	0.97	1.05	58MV(B,C)100-20
CAP**6025A**	0.95	1.05	58MV(B,C)100-20
CNPH*4821A**	0.95	1.04	58MV(B,C)100-20
CNPH*6024A**	0.97	1.05	58MV(B,C)100-20
CNPH*6124A**	0.98	1.06	58MV(B,C)100-20
CNPH*4821A**	0.95	1.04	58MV(B,C)100-20
CNPH*4824A**	0.95	1.04	58MV(B,C)100-20
CNPH*6024A**	0.97	1.05	58MV(B,C)100-20
CNPH*6124A**	0.99	1.05	58MV(B,C)100-20
CSPH*4812A**	0.96	1.06	58MV(B,C)100-20
CSPH*6012A**	0.97	1.05	58MV(B,C)100-20
CAP**4824A**	0.95	1.02	58MV(B,C)120-20
CAP**6024A**	0.97	1.03	58MV(B,C)120-20
CAP**6025A**	0.96	1.03	58MV(B,C)120-20
CNPH*4821A**	0.96	1.03	58MV(B,C)120-20
CNPH*6024A**	0.97	1.03	58MV(B,C)120-20
CNPH*6124A**	0.98	1.04	58MV(B,C)120-20
CNPH*4824A**	0.96	1.03	58MV(B,C)120-20

COOLING INDOOR MODEL	CAPACITY	POWER	FURNACE MODEL
CNPH*6024A**	0.97	1.03	58MV(B,C)120-20
CNPH*6124A**	0.99	1.03	58MV(B,C)120-20
CSPH*4812A**	0.96	1.03	58MV(B,C)120-20
CSPH*6012A**	0.98	1.03	58MV(B,C)120-20
CAP**4821A**	0.94	1.05	59*N*A100V21**20
CAP**4823A**	0.94	1.05	59*N*A100V21**20
CAP**4824A**	0.95	1.06	59*N*A100V21**20
CAP**6021A**	0.96	1.05	59*N*A100V21**20
CAP**6024A**	0.97	1.05	59*N*A100V21**20
CAP**6025A**	0.97	1.05	59*N*A100V21**20
CNPH*4821A**	0.95	1.05	59*N*A100V21**20
CNPH*6024A**	0.97	1.05	59*N*A100V21**20
CNPH*6124A**	0.98	1.06	59*N*A100V21**20
CNPH*4821A**	0.95	1.05	59*N*A100V21**20
CNPH*4824A**	0.95	1.05	59*N*A100V21**20
CNPH*6024A**	0.96	1.05	59*N*A100V21**20
CSPH*4812A**	0.96	1.07	59*N*A100V21**20
CSPH*6012A**	0.98	1.06	59*N*A100V21**20

See notes on page 24

HEAT PUMP HEATING PERFORMANCE

INDOOR AIR		OUTDOOR COIL ENTERING AIR TEMPERATURES °F (°C)														
		-3 (-19.4)			7 (-13.9)			17 (-8.3)			27 (-2.8)					
EDB °F (°C)	ID SCFM	Capacity MBtuh		Total Sys. KWt	ID SCFM	Capacity MBtuh		Total Sys. KWt	ID SCFM	Capacity MBtuh		Total Sys. KWt	Capacity MBtuh		Total Sys. KWt	
		Total	Integ*			Total	Integ*			Total	Integ*		Total	Integ*		
65 (18.3)	900	17.60	16.19	2.39	900	22.65	20.82	2.68	900	26.64	24.29	2.80	29.76	26.43	2.74	
70 (21.1)		17.28	15.90	2.51		22.37	20.56	2.83		26.37	24.05	2.96		29.51	26.21	2.91
75 (23.9)		16.92	15.57	2.62		22.05	20.26	2.97		26.09	23.79	3.12		29.24	25.97	3.08

INDOOR AIR		OUTDOOR COIL ENTERING AIR TEMPERATURES °F (°C)														
		47 (8.3)			57 (13.9)			67 (19.4)								
EDB °F (°C)	ID SCFM	Capacity MBtuh		Total Sys. KWt	ID SCFM	Capacity MBtuh		Total Sys. KWt	ID SCFM	Capacity MBtuh		Total Sys. KWt	Capacity MBtuh		Total Sys. KWt	
		Total	Integ*			Total	Integ*			Total	Integ*		Total	Integ*		
65 (18.3)	900	27.30	24.84	2.02	900	23.84	23.84	1.36	900	27.25	27.25	1.34	31.00	31.00	1.33	
70 (21.1)		27.07	24.63	2.16		23.60	23.60	1.47		26.98	26.98	1.45		30.70	30.70	1.44
75 (23.9)		26.83	24.41	2.32		23.36	23.36	1.59		26.71	26.71	1.57		30.39	30.39	1.56

INDOOR AIR		OUTDOOR COIL ENTERING AIR TEMPERATURES °F (°C)														
		-3 (-19.4)			7 (-13.9)			17 (-8.3)			27 (-2.8)					
EDB °F (°C)	ID SCFM	Capacity MBtuh		Total Sys. KWt	ID SCFM	Capacity MBtuh		Total Sys. KWt	ID SCFM	Capacity MBtuh		Total Sys. KWt	Capacity MBtuh		Total Sys. KWt	
		Total	Integ*			Total	Integ*			Total	Integ*		Total	Integ*		
65 (18.3)	500	10.11	9.30	1.34	500	12.64	11.62	1.40	500	15.28	13.94	1.45	16.85	14.97	1.37	
70 (21.1)		9.83	9.05	1.41		12.41	11.40	1.48		15.07	13.74	1.54		16.65	14.79	1.46
75 (23.9)		9.53	8.76	1.47		12.15	11.17	1.56		14.84	13.53	1.63		16.44	14.60	1.56

INDOOR AIR		OUTDOOR COIL ENTERING AIR TEMPERATURES °F (°C)														
		47 (8.3)			57 (13.9)			67 (19.4)								
EDB °F (°C)	ID SCFM	Capacity MBtuh		Total Sys. KWt	ID SCFM	Capacity MBtuh		Total Sys. KWt	ID SCFM	Capacity MBtuh		Total Sys. KWt	Capacity MBtuh		Total Sys. KWt	
		Total	Integ*			Total	Integ*			Total	Integ*		Total	Integ*		
65 (18.3)	500	16.89	15.37	1.14	500	14.71	14.71	0.79	500	17.12	17.12	0.78	19.72	19.72	0.77	
70 (21.1)		16.70	15.19	1.22		14.51	14.51	0.85		16.90	16.90	0.84		19.48	19.48	0.83
75 (23.9)		16.49	15.01	1.31		14.31	14.31	0.92		16.68	16.68	0.91		19.23	19.23	0.90

HEAT PUMP HEATING PERFORMANCE CONTINUED

25VNA024A**30 Outdoor Section With FxANB006 Indoor Section

HEATING INDOOR MODEL	CAPACITY	POWER	FURNACE MODEL
CSPH*4212A**	0.98	1.04	59MN7A060V21**20
CSPH*4812A**	0.98	1.04	59MN7A060V21**20
CSPH*6012A**	0.98	1.02	59MN7A060V21**20

See notes on page 36

HEATING INDOOR MODEL	CAPACITY	POWER	FURNACE MODEL
CSPH*3612A**	1.01	1.10	59*N*A100V21**20
CSPH*4212A**	1.01	1.07	59*N*A100V21**20
CSPH*4812A**	0.99	1.04	59*N*A100V21**20
CSPH*6012A**	0.99	1.02	59*N*A100V21**20
CAP**3621A**	0.97	1.05	59*N*A100V21**22
CAP**4221A**	0.97	1.04	59*N*A100V21**22
CAP**4224A**	0.97	1.04	59*N*A100V21**22
CAP**4821A**	0.97	1.01	59*N*A100V21**22
CAP**4824A**	0.97	1.00	59*N*A100V21**22
CAP**6021A**	0.97	1.00	59*N*A100V21**22
CAP**6024A**	0.97	1.00	59*N*A100V21**22
CNPH*4221A**	0.98	1.05	59*N*A100V21**22
CNPH*4224A**	0.98	1.05	59*N*A100V21**22
CNPH*4821A**	0.97	1.01	59*N*A100V21**22
CNPH*4824A**	0.98	1.00	59*N*A100V21**22
CNPV*3621A**	0.99	1.08	59*N*A100V21**22
CNPV*4221A**	0.97	1.05	59*N*A100V21**22
CNPV*4224A**	0.97	1.01	59*N*A100V21**22
CNPV*6024A**	0.98	1.00	59*N*A100V21**22
CSPH*3612A**	0.98	1.04	59*N*A100V21**22
CSPH*4212A**	0.97	1.01	59*N*A100V21**22
CSPH*4812A**	0.97	1.01	59*N*A100V21**22
CSPH*6012A**	0.98	1.00	59*N*A100V21**22
CAP**4224A**	1.00	1.09	59*N*A120V24**22
CAP**4824A**	0.97	1.01	59*N*A120V24**22
CAP**6024A**	0.96	0.98	59*N*A120V24**22
CNPH*3617A**	1.02	1.23	59*N*A120V24**22
CNPH*4221A**	1.02	1.14	59*N*A120V24**22
CNPH*4321A**	0.97	0.99	59*N*A120V24**22
CNPH*4821A**	0.98	1.02	59*N*A120V24**22
CNPH*6024A**	0.99	1.01	59*N*A120V24**22
CNPH*6124A**	0.98	1.00	59*N*A120V24**22
CNPV*4324A**	0.97	0.98	59*N*A120V24**22
CNPV*4824A**	0.98	1.02	59*N*A120V24**22
CNPV*6024A**	0.99	1.01	59*N*A120V24**22
CNPV*6124A**	0.98	0.98	59*N*A120V24**22
CSPH*3612A**	1.01	1.09	59*N*A120V24**22
CSPH*4212A**	1.00	1.05	59*N*A120V24**22
CSPH*4812A**	0.98	1.02	59*N*A120V24**22
CSPH*6012A**	0.99	1.01	59*N*A120V24**22
CAP**3621A**	0.97	1.08	59MN7A060V21**20
CAP**4221A**	0.97	1.06	59MN7A060V21**20
CAP**4224A**	0.97	1.06	59MN7A060V21**20
CAP**4821A**	0.97	1.03	59MN7A060V21**20
CAP**4824A**	0.97	1.02	59MN7A060V21**20
CAP**6021A**	0.97	1.02	59MN7A060V21**20
CAP**6024A**	0.97	1.02	59MN7A060V21**20
CNPH*4221A**	0.99	1.08	59MN7A060V21**20
CNPH*4224A**	0.98	1.04	59MN7A060V21**20
CNPH*4821A**	0.99	1.03	59MN7A060V21**20
CNPH*6024A**	0.99	1.10	59MN7A060V21**20
CNPV*4221A**	0.98	1.08	59MN7A060V21**20
CNPV*4824A**	0.99	1.04	59MN7A060V21**20
CNPV*6024A**	0.99	1.03	59MN7A060V21**20
CSPH*3612A**	0.98	1.05	59MN7A060V21**20

HEAT PUMP HEATING PERFORMANCE CONTINUED

INDOOR AIR		OUTDOOR COIL ENTERING AIR TEMPERATURES ° F (° C)																		
		-3 (-19.4)					7 (-13.9)					17 (-8.3)					27 (-2.8)			
EDB ° F (° C)	ID SCFM	Capacity MBtuh		Total System KW†	ID SCFM	Capacity MBtuh		Total System KW†	ID SCFM	Capacity MBtuh		Total System KW†	ID SCFM	Capacity MBtuh		Total System KW†	ID SCFM	Capacity MBtuh		Total System KW†
		Total	Integ*			Total	Integ*			Total	Integ*			Total	Integ*			Total	Integ*	
65 (18.3)	1200	20.64	18.99	2.67	1200	27.29	25.07	3.07	1350	32.39	29.53	3.12	1200	36.70	32.59	3.19	1200	36.70	32.59	3.19
70 (21.1)		20.35	18.72	2.80		27.01	24.82	3.23		32.14	29.30	3.30		36.42	32.35	3.37				
75 (23.9)		20.00	18.40	2.92		26.71	24.54	3.39		31.86	29.05	3.48		36.14	32.10	3.57				

INDOOR AIR		OUTDOOR COIL ENTERING AIR TEMPERATURES ° F (° C)														
		47 (8.3)					57 (13.9)					67 (19.4)				
EDB ° F (° C)	ID SCFM	Capacity MBtuh		Total System KW†	ID SCFM	Capacity MBtuh		Total System KW†	ID SCFM	Capacity MBtuh		Total System KW†	ID SCFM	Capacity MBtuh		Total System KW†
		Total	Integ*			Total	Integ*			Total	Integ*			Total	Integ*	
65 (18.3)	1200	32.94	29.98	2.25	1200	33.69	33.69	1.93	1200	37.63	37.63	1.89	1200	42.35	42.35	1.87
70 (21.1)		32.69	29.74	2.41		33.40	33.40	2.07		37.22	37.22	2.04		41.77	41.77	2.02
75 (23.9)		32.42	29.51	2.57		33.10	33.10	2.23		36.86	36.86	2.20		41.22	41.22	2.17

INDOOR AIR		OUTDOOR COIL ENTERING AIR TEMPERATURES ° F (° C)																		
		-3 (-19.4)					7 (-13.9)					17 (-8.3)					27 (-2.8)			
EDB ° F (° C)	ID SCFM	Capacity MBtuh		Total System KW†	ID SCFM	Capacity MBtuh		Total System KW†	ID SCFM	Capacity MBtuh		Total System KW†	ID SCFM	Capacity MBtuh		Total System KW†	ID SCFM	Capacity MBtuh		Total System KW†
		Total	Integ*			Total	Integ*			Total	Integ*			Total	Integ*			Total	Integ*	
65 (18.3)	500	9.92	9.12	1.74	500	12.30	11.31	1.79	500	14.73	13.43	1.72	520	16.31	14.48	1.58				
70 (21.1)		9.66	8.89	1.82		12.09	11.11	1.89		14.54	13.25	1.83		16.12	14.32	1.69				
75 (23.9)		9.37	8.62	1.89		11.85	10.89	1.99		14.33	13.06	1.94		15.93	14.15	1.81				

INDOOR AIR		OUTDOOR COIL ENTERING AIR TEMPERATURES ° F (° C)																		
		37 (2.8)					47 (8.3)					57 (13.9)					67 (19.4)			
EDB ° F (° C)	ID SCFM	Capacity MBtuh		Total System KW†	ID SCFM	Capacity MBtuh		Total System KW†	ID SCFM	Capacity MBtuh		Total System KW†	ID SCFM	Capacity MBtuh		Total System KW†	ID SCFM	Capacity MBtuh		Total System KW†
		Total	Integ*			Total	Integ*			Total	Integ*			Total	Integ*			Total	Integ*	
65 (18.3)	500	15.31	13.93	1.23	500	13.54	13.54	0.87	500	15.51	15.51	0.84	500	17.68	17.68	0.82				
70 (21.1)		15.12	13.76	1.32		13.34	13.34	0.95		15.25	15.25	0.92		17.36	17.36	0.89				
75 (23.9)		14.94	13.59	1.42		13.13	13.13	1.03		15.00	15.00	1.00		17.05	17.05	0.97				

HEAT PUMP HEATING PERFORMANCE CONTINUED

25VNA036A**30 Outdoor Section With FE4ANB006 Indoor Section

HEATING INDOOR MODEL	CAPACITY	POWER	FURNACE MODEL
CAP**3621A**	1.02	1.13	59*N*A100V21**22
CAP**4221A**	1.02	1.11	59*N*A100V21**22
CAP**4224A**	1.02	1.11	59*N*A100V21**22
CAP**4821A**	1.01	1.06	59*N*A100V21**22
CAP**4824A**	1.01	1.06	59*N*A100V21**22
CAP**6021A**	0.99	1.03	59*N*A100V21**22
CAP**6024A**	0.99	1.03	59*N*A100V21**22
CNPH*4221A**	1.02	1.12	59*N*A100V21**22
CNPH*4821A**	1.01	1.06	59*N*A100V21**22
CNPH*6024A**	1.01	1.04	59*N*A100V21**22
CNPV*4221A**	1.02	1.12	59*N*A100V21**22
CNPV*4821A**	1.01	1.06	59*N*A100V21**22
CNPV*4824A**	1.01	1.06	59*N*A100V21**22
CNPV*6024A**	1.01	1.04	59*N*A100V21**22
CSPH*3612A**	1.02	1.09	59*N*A100V21**22
CSPH*4212A**	1.01	1.07	59*N*A100V21**22
CSPH*4812A**	1.01	1.06	59*N*A100V21**22
CSPH*6012A**	1.01	1.04	59*N*A100V21**22
CAP**4224A**	1.05	1.18	59*N*A120V24**22
CAP**6024A**	0.98	1.02	59*N*A120V24**22
CAP**6025A**	1.01	1.04	59*N*A120V24**22
CNPH*3617A**	1.08	1.38	59*N*A120V24**22
CNPH*4221A**	1.04	1.16	59*N*A120V24**22
CNPH*4321A**	1.00	1.03	59*N*A120V24**22
CNPH*4821A**	1.02	1.07	59*N*A120V24**22
CNPH*6024A**	1.00	1.03	59*N*A120V24**22
CNPH*6124A**	0.99	1.02	59*N*A120V24**22
CNPV*4324A**	1.00	1.02	59*N*A120V24**22
CNPV*4824A**	1.02	1.07	59*N*A120V24**22
CNPV*6024A**	1.01	1.04	59*N*A120V24**22
CNPV*6124A**	0.99	1.00	59*N*A120V24**22
CSPH*3612A**	1.05	1.17	59*N*A120V24**22
CSPH*4212A**	1.04	1.10	59*N*A120V24**22
CSPH*4812A**	1.01	1.05	59*N*A120V24**22
CSPH*6012A**	1.00	1.03	59*N*A120V24**22
CAP**3621A**	1.02	1.17	59MN7A060V21**20
CAP**4221A**	1.02	1.14	59MN7A060V21**20
CAP**4224A**	1.02	1.14	59MN7A060V21**20
CAP**4821A**	1.01	1.10	59MN7A060V21**20
CAP**4824A**	0.98	1.07	59MN7A060V21**20
CAP**6021A**	0.99	1.06	59MN7A060V21**20
CAP**6024A**	0.99	1.06	59MN7A060V21**20
CNPH*4221A**	1.02	1.16	59MN7A060V21**20
CNPH*4821A**	1.01	1.09	59MN7A060V21**20
CNPH*6024A**	1.01	1.07	59MN7A060V21**20
CNPV*4221A**	1.02	1.16	59MN7A060V21**20
CNPV*4821A**	1.01	1.09	59MN7A060V21**20
CNPV*4824A**	1.02	1.10	59MN7A060V21**20

HEATING INDOOR MODEL	CAPACITY	POWER	FURNACE MODEL
CNPV*6024A**	1.01	1.07	59MN7A060V21**20
CSPH*3612A**	1.02	1.12	59MN7A060V21**20
CSPH*4212A**	1.02	1.10	59MN7A060V21**20
CSPH*4812A**	1.01	1.09	59MN7A060V21**20
CSPH*6012A**	1.01	1.07	59MN7A060V21**20

See notes on page 36

HEAT PUMP HEATING PERFORMANCE CONTINUED

INDOOR AIR		OUTDOOR COIL ENTERING AIR TEMPERATURES ° F (° C)										
		-3 (-19.4)			7 (-13.9)			17 (-8.3)			27 (-2.8)	
EDB ° F (° C)	ID SCFM	Capacity MBtuh		Total System KWt	ID SCFM	Capacity MBtuh		Total System KWt	ID SCFM	Capacity MBtuh		Total System KWt
		Total	Integ*			Total	Integ*			Total	Integ*	
65 (18.3)	1800	31.83	29.29	3.91	1800	43.78	40.23	4.98	1800	52.18	47.57	5.41
70 (21.1)		31.46	28.95	4.07		43.42	39.90	5.20		51.86	47.28	5.66
75 (23.9)		31.02	28.54	4.23		43.01	39.53	5.42		51.52	46.97	5.91
25VNA048A**30 Outdoor Section With FE4ANB006 Indoor Section - Maximum												
65 (18.3)	1800	53.92	47.89	4.78	1800	53.57	47.58	5.01	1800	53.21	47.26	5.26
70 (21.1)		53.57	47.58	5.01		53.21	47.26	5.26				
75 (23.9)		53.21	47.26	5.26		53.21	47.26	5.26				

INDOOR AIR		OUTDOOR COIL ENTERING AIR TEMPERATURES ° F (° C)										
		37 (2.8)			47 (8.3)			57 (13.9)			67 (19.4)	
EDB ° F (° C)	ID SCFM	Capacity MBtuh		Total System KWt	ID SCFM	Capacity MBtuh		Total System KWt	ID SCFM	Capacity MBtuh		Total System KWt
		Total	Integ*			Total	Integ*			Total	Integ*	
65 (18.3)	1800	51.12	46.52	3.76	1800	45.90	45.90	2.80	1800	52.16	52.16	2.89
70 (21.1)		50.74	46.17	3.96		45.50	45.50	2.96		51.68	51.68	3.05
75 (23.9)		50.35	45.82	4.17		45.11	45.11	3.13		51.18	51.18	3.22
25VNA048A**30 Outdoor Section With FE4ANB006 Indoor Section - Maximum												
65 (18.3)	1800	58.98	58.98	2.99	1800	58.38	58.38	3.15	1800	57.74	57.74	3.31
70 (21.1)		58.38	58.38	3.15		58.38	58.38	3.15		57.74	57.74	3.31
75 (23.9)		57.74	57.74	3.31		57.74	57.74	3.31		57.74	57.74	3.31

INDOOR AIR		OUTDOOR COIL ENTERING AIR TEMPERATURES ° F (° C)										
		-3 (-19.4)			7 (-13.9)			17 (-8.3)			27 (-2.8)	
EDB ° F (° C)	ID SCFM	Capacity MBtuh		Total System KWt	ID SCFM	Capacity MBtuh		Total System KWt	ID SCFM	Capacity MBtuh		Total System KWt
		Total	Integ*			Total	Integ*			Total	Integ*	
65 (18.3)	580	17.91	16.48	2.28	580	22.07	20.28	2.49	580	26.40	24.07	2.53
70 (21.1)		17.53	16.13	2.37		21.76	20.00	2.60		26.15	23.84	2.66
75 (23.9)		17.09	15.73	2.45		21.40	19.67	2.71		25.87	23.58	2.80
25VNA048A**30 Outdoor Section With FE4ANB006 Indoor Section - Minimum												
65 (18.3)	580	30.60	27.18	2.47	580	30.36	26.96	2.62	580	30.10	26.73	2.77
70 (21.1)		30.36	26.96	2.62		30.36	26.96	2.62		30.10	26.73	2.77
75 (23.9)		30.10	26.73	2.77		30.10	26.73	2.77		30.10	26.73	2.77

INDOOR AIR		OUTDOOR COIL ENTERING AIR TEMPERATURES ° F (° C)										
		37 (2.8)			47 (8.3)			57 (13.9)			67 (19.4)	
EDB ° F (° C)	ID SCFM	Capacity MBtuh		Total System KWt	ID SCFM	Capacity MBtuh		Total System KWt	ID SCFM	Capacity MBtuh		Total System KWt
		Total	Integ*			Total	Integ*			Total	Integ*	
65 (18.3)	700	28.71	26.13	2.08	700	24.62	24.62	1.49	780	28.16	28.16	1.44
70 (21.1)		28.46	25.90	2.21		24.37	24.37	1.59		27.86	27.86	1.53
75 (23.9)		28.21	25.67	2.34		24.11	24.11	1.69		27.56	27.56	1.63
25VNA048A**30 Outdoor Section With FE4ANB006 Indoor Section - Minimum												
65 (18.3)	700	31.91	31.91	1.47	700	31.58	31.58	1.57	820	31.21	31.21	1.66
70 (21.1)		31.58	31.58	1.57		31.58	31.58	1.57		31.58	31.58	1.57
75 (23.9)		31.21	31.21	1.66		31.21	31.21	1.66		31.21	31.21	1.66

HEAT PUMP HEATING PERFORMANCE CONTINUED

25VNA048A**30 Outdoor Section With FE4ANB006 Indoor Section

HEATING INDOOR MODEL	CAPACITY	POWER	FURNACE MODEL
*FE4ANB006	1.00	1.00	
FE4AN(B)F005	1.02	1.07	
CAP**4817A**	1.00	1.08	58CV(A,X)090-16
CAP**4821A**	1.01	1.10	58CV(A,X)090-16
CAP**6021A**	0.99	1.06	58CV(A,X)090-16
CNP**4821A**	1.02	1.10	58CV(A,X)090-16
CNP**6024A**	1.00	1.07	58CV(A,X)090-16
CNP**6124A**	1.01	1.06	58CV(A,X)090-16
CNP**4821A**	1.02	1.10	58CV(A,X)090-16
CSPH**6124A**	1.00	1.06	58CV(A,X)090-16
CSPH**6024A**	1.00	1.08	58CV(A,X)110-20
CAP**4821A**	1.00	1.08	58CV(A,X)110-20
CAP**4823A**	1.00	1.07	58CV(A,X)110-20
CAP**4824A**	1.00	1.07	58CV(A,X)110-20
CAP**6021A**	0.99	1.05	58CV(A,X)110-20
CAP**6024A**	0.99	1.04	58CV(A,X)110-20
CAP**6025A**	0.99	1.04	58CV(A,X)110-20
CNP**4821A**	1.01	1.08	58CV(A,X)110-20
CNP**6024A**	1.00	1.05	58CV(A,X)110-20
CNP**6124A**	1.01	1.05	58CV(A,X)110-20
CNP**4821A**	1.01	1.08	58CV(A,X)110-20
CNP**6024A**	1.00	1.06	58CV(A,X)110-20
CNP**6124A**	1.01	1.04	58CV(A,X)110-20
CSPH**4812A**	1.01	1.08	58CV(A,X)110-20
CSPH**6012A**	0.99	1.03	58CV(A,X)135-22
CAP**4824A**	1.00	1.06	58CV(A,X)135-22
CNP**6124A**	0.99	1.03	58CV(A,X)135-22
CNP**4824A**	1.01	1.06	58CV(A,X)135-22
CNP**6024A**	1.02	1.03	58CV(A,X)135-22
CSPH**4812A**	1.01	1.06	58CV(A,X)135-22
CSPH**6012A**	0.99	1.02	58CV(A,X)135-22
CAP**6025A**	1.00	1.06	58CV(A,X)155-22
CNP**4821A**	1.01	1.06	58CV(A,X)155-22
CNP**6024A**	1.02	1.02	58CV(A,X)155-22
CSPH**4812A**	1.01	1.06	58CV(A,X)155-22
CSPH**6012A**	0.99	1.01	58CV(A,X)155-22
CAP**4824A**	1.00	1.01	58CV(A,X)155-22
CNP**4824A**	1.01	1.06	58CV(A,X)155-22
CNP**6024A**	1.00	1.01	58CV(A,X)155-22
CNP**6124A**	1.01	1.06	58CV(A,X)155-22
CNP**4821A**	1.01	1.05	58CV(A,X)155-22
CSPH**4812A**	1.00	1.00	58CV(A,X)155-22
CSPH**6012A**	0.99	1.00	58CV(A,X)155-22
CAP**4824A**	1.01	1.09	59*N*A080V21**20
CAP**6024A**	1.00	1.06	59*N*A080V21**20
CNP**4821A**	1.02	1.10	59*N*A080V21**20
CNP**6024A**	1.00	1.06	59*N*A080V21**20
CNP**6124A**	1.01	1.10	59*N*A080V21**20
CNP**4821A**	1.01	1.06	59*N*A080V21**20
CNP**6024A**	1.02	1.10	59*N*A080V21**20
CNP**6124A**	1.01	1.07	59*N*A080V21**20
CNP**4821A**	1.01	1.07	59*N*A080V21**20
CNP**6024A**	1.01	1.07	59*N*A080V21**20

HEATING INDOOR MODEL	CAPACITY	POWER	FURNACE MODEL
CNPV*4821A**	1.02	1.10	59*N*A080V21**20
CNPV*4824A**	1.02	1.10	59*N*A080V21**20
CNPV*6024A**	1.01	1.07	59*N*A080V21**20
CSPH*4812A**	1.01	1.08	59*N*A080V21**20
CSPH*6012A**	1.00	1.05	59*N*A080V21**20
CAP**4821A**	1.01	1.08	59*N*A100V21**22
CAP**4824A**	1.00	1.07	59*N*A100V21**22
CAP**6021A**	1.00	1.05	59*N*A100V21**22
CAP**6024A**	1.00	1.05	59*N*A100V21**22
CNP**4821A**	1.01	1.08	59*N*A100V21**22
CNP**6024A**	1.01	1.06	59*N*A100V21**22
CNP**6124A**	1.01	1.08	59*N*A100V21**22
CNPV*4821A**	1.01	1.08	59*N*A100V21**22
CNPV*6024A**	1.01	1.06	59*N*A100V21**22
CSPH*4812A**	1.01	1.08	59*N*A100V21**22
CSPH*6012A**	1.01	1.06	59*N*A100V21**22
CAP**4821A**	1.01	1.07	59*N*A120V24**22
CAP**4824A**	1.00	1.07	59*N*A120V24**22
CAP**6025A**	0.98	1.04	59*N*A120V24**22
CNP**4821A**	1.01	1.09	59*N*A120V24**22
CNP**6024A**	1.01	1.07	59*N*A120V24**22
CNP**6124A**	1.01	1.04	59*N*A120V24**22
CNPV*4821A**	1.01	1.08	59*N*A120V24**22
CNPV*6024A**	1.01	1.06	59*N*A120V24**22
CSPH*4812A**	1.01	1.09	59*N*A120V24**22
CSPH*6012A**	1.01	1.05	59*N*A120V24**22
CAP**4821A**	1.01	1.14	59MN7A060V21**20
CAP**4824A**	1.01	1.13	59MN7A060V21**20
CAP**6021A**	1.00	1.10	59MN7A060V21**20
CAP**6024A**	1.00	1.10	59MN7A060V21**20
CNP**4821A**	1.02	1.14	59MN7A060V21**20
CNP**6024A**	1.01	1.11	59MN7A060V21**20
CNP**6124A**	1.02	1.14	59MN7A060V21**20
CNPV*4821A**	1.02	1.14	59MN7A060V21**20
CNPV*6024A**	1.01	1.11	59MN7A060V21**20
CSPH*4812A**	1.01	1.11	59MN7A060V21**20
CSPH*6012A**	1.01	1.13	59MN7A060V21**20
CAP**4821A**	1.01	1.10	59MN7A060V21**20
CAP**4823A**	1.01	1.12	58MV(B,C)080-20
CAP**4824A**	1.01	1.12	58MV(B,C)080-20
CAP**6024A**	1.00	1.09	58MV(B,C)080-20
CAP**6025A**	1.00	1.09	58MV(B,C)080-20
CNP**4821A**	1.02	1.13	58MV(B,C)080-20
CNP**6024A**	1.00	1.08	58MV(B,C)080-20
CNP**6124A**	1.01	1.11	58MV(B,C)080-20
CNPV*4821A**	1.00	1.09	58MV(B,C)080-20
CNPV*6024A**	1.00	1.08	58MV(B,C)080-20
CSPH*4812A**	1.02	1.13	58MV(B,C)080-20
CSPH*6012A**	1.02	1.13	58MV(B,C)080-20
CAP**4824A**	1.00	1.08	58MV(B,C)080-20
CNP**4821A**	1.02	1.12	58MV(B,C)080-20
CNP**6024A**	1.00	1.12	58MV(B,C)080-20
CNP**6124A**	1.01	1.12	58MV(B,C)080-20
CNPV*4821A**	1.00	1.12	58MV(B,C)080-20
CNPV*6024A**	1.00	1.07	58MV(B,C)080-20
CSPH*4812A**	1.01	1.12	58MV(B,C)080-20
CSPH*6012A**	1.01	1.12	58MV(B,C)100-20
CAP**4821A**	1.01	1.12	58MV(B,C)100-20

HEATING INDOOR MODEL	CAPACITY	POWER	FURNACE MODEL
CAP**4823A**	1.01	1.12	58MV(B,C)100-20
CAP**4824A**	1.01	1.11	58MV(B,C)100-20
CAP**6021A**	0.99	1.07	58MV(B,C)100-20
CAP**6024A**	0.99	1.07	58MV(B,C)100-20
CNP**4821A**	1.02	1.12	58MV(B,C)100-20
CNP**6024A**	1.00	1.08	58MV(B,C)100-20
CNP**6124A**	1.01	1.11	58MV(B,C)100-20
CNPV*4821A**	1.00	1.08	58MV(B,C)100-20
CNPV*6024A**	1.01	1.08	58MV(B,C)100-20
CSPH*4812A**	1.00	1.08	58MV(B,C)100-20
CSPH*6012A**	1.00	1.07	58MV(B,C)100-20
CAP**4824A**	1.00	1.08	58MV(B,C)120-20
CAP**6024A**	0.99	1.06	58MV(B,C)120-20
CNP**4824A**	1.01	1.06	58MV(B,C)120-20
CNP**6124A**	1.01	1.09	58MV(B,C)120-20
CNPV*4824A**	1.00	1.06	58MV(B,C)120-20
CNPV*6124A**	1.01	1.06	58MV(B,C)120-20
CSPH*4812A**	1.00	1.11	58MV(B,C)120-20
CSPH*6012A**	1.00	1.11	58MV(B,C)120-20
CAP**4823A**	1.01	1.13	59*N*A100V21**20
CAP**4824A**	1.00	1.11	59*N*A100V21**20
CAP**6021A**	0.99	1.08	59*N*A100V21**20
CAP**6024A**	0.99	1.08	59*N*A100V21**20
CNP**4821A**	1.01	1.11	59*N*A100V21**20
CNP**6024A**	1.02	1.11	59*N*A100V21**20
CNP**6124A**	1.01	1.11	59*N*A100V21**20
CNPV*4821A**	1.01	1.11	59*N*A100V21**20
CNPV*6024A**	1.01	1.11	59*N*A100V21**20
CSPH*4812A**	1.01	1.11	59*N*A100V21**20
CSPH*6012A**	1.01	1.11	59*N*A100V21**20
CAP**4824A**	1.01	1.09	59*N*A100V21**20
CNP**4821A**	1.01	1.11	59*N*A100V21**20
CNP**6024A**	1.01	1.11	59*N*A100V21**20
CNP**6124A**	1.01	1.11	59*N*A100V21**20
CNPV*4821A**	1.01	1.11	59*N*A100V21**20
CNPV*6024A**	1.01	1.11	59*N*A100V21**20
CSPH*4812A**	1.01	1.11	59*N*A100V21**20
CSPH*6012A**	1.01	1.11	59*N*A100V21**20
CAP**6012A**	1.02	1.09	59*N*A100V21**20

See notes on page 36

HEAT PUMP HEATING PERFORMANCE CONTINUED

INDOOR AIR		OUTDOOR COIL ENTERING AIR TEMPERATURES ° F (° C)														
		-3 (-19.4)			7 (-13.9)			17 (-8.3)			27 (-2.8)					
EDB ° F (° C)	ID SCFM	Capacity MBtuh		Total System KW†	ID SCFM	Capacity MBtuh		Total System KW†	ID SCFM	Capacity MBtuh		Total System KW†	Capacity MBtuh		Total System KW†	
		Total	Integ*			Total	Integ*			Total	Integ*		Total	Integ*		
65 (18.3)	2250	37.76	34.74	5.33	2250	45.75	42.05	5.79	2250	56.63	51.63	6.62	2100	62.81	55.61	6.44
70 (21.1)		37.37	34.38	5.54		45.42	41.74	6.03		56.32	51.35	6.91		62.22	55.26	6.73
75 (23.9)		36.90	33.94	5.73		45.04	41.39	6.28		55.97	51.03	7.21		61.83	54.92	7.04
25VNA060A**30 Outdoor Section With FE4ANB006 Indoor Section – Maximum																

INDOOR AIR		OUTDOOR COIL ENTERING AIR TEMPERATURES ° F (° C)														
		37 (2.8)			47 (8.3)			57 (13.9)			67 (19.4)					
EDB ° F (° C)	ID SCFM	Capacity MBtuh		Total System KW†	ID SCFM	Capacity MBtuh		Total System KW†	ID SCFM	Capacity MBtuh		Total System KW†	Capacity MBtuh		Total System KW†	
		Total	Integ*			Total	Integ*			Total	Integ*		Total	Integ*		
65 (18.3)	2000	60.88	55.40	5.22	2000	55.78	55.78	3.95	1700	57.61	57.61	3.57	1625	59.14	59.14	3.23
70 (21.1)		60.45	55.01	5.48		55.30	55.30	4.15		57.05	57.05	3.76		58.51	58.51	3.40
75 (23.9)		59.99	54.59	5.74		54.83	54.83	4.37		56.50	56.50	3.96		57.89	57.89	3.58
25VNA060A**30 Outdoor Section With FE4ANB006 Indoor Section – Maximum																

INDOOR AIR		OUTDOOR COIL ENTERING AIR TEMPERATURES ° F (° C)														
		-3 (-19.4)			7 (-13.9)			17 (-8.3)			27 (-2.8)					
EDB ° F (° C)	ID SCFM	Capacity MBtuh		Total System KW†	ID SCFM	Capacity MBtuh		Total System KW†	ID SCFM	Capacity MBtuh		Total System KW†	Capacity MBtuh		Total System KW†	
		Total	Integ*			Total	Integ*			Total	Integ*		Total	Integ*		
65 (18.3)	580	18.15	16.70	2.51	580	22.36	20.55	2.74	700	26.75	24.39	2.78	800	31.31	27.80	2.82
70 (21.1)		17.77	16.34	2.61		22.05	20.26	2.86		26.49	24.16	2.93		31.05	27.58	2.98
75 (23.9)		17.32	15.93	2.69		21.68	19.93	2.98		26.21	23.89	3.08		30.78	27.34	3.15
25VNA060A**30 Outdoor Section With FE4ANB006 Indoor Section – Minimum																

INDOOR AIR		OUTDOOR COIL ENTERING AIR TEMPERATURES ° F (° C)														
		37 (2.8)			47 (8.3)			57 (13.9)			67 (19.4)					
EDB ° F (° C)	ID SCFM	Capacity MBtuh		Total System KW†	ID SCFM	Capacity MBtuh		Total System KW†	ID SCFM	Capacity MBtuh		Total System KW†	Capacity MBtuh		Total System KW†	
		Total	Integ*			Total	Integ*			Total	Integ*		Total	Integ*		
65 (18.3)	700	29.07	26.45	2.29	625	24.94	24.94	1.65	800	28.56	28.56	1.57	815	32.32	32.32	1.62
70 (21.1)		28.82	26.22	2.43		24.69	24.69	1.75		28.25	28.25	1.67		31.99	31.99	1.73
75 (23.9)		28.56	25.99	2.57		24.43	24.43	1.86		27.94	27.94	1.78		31.62	31.62	1.83
25VNA060A**30 Outdoor Section With FE4ANB006 Indoor Section – Minimum																



HEAT PUMP HEATING PERFORMANCE CONTINUED

25VNA060A**30 Outdoor Section With FE4ANB006 Indoor Section

HEATING INDOOR MODEL	CAPACITY	POWER	FURNACE MODEL
*FE4ANB006	1.00	1.00	
CAP**6021A**	1.00	1.05	58CV(A,X)110-20
CNPH*6024A**	1.00	1.04	58CV(A,X)110-20
CNPH*6124A**	0.99	1.03	58CV(A,X)110-20
CNPH*6024A**	1.03	1.08	58CV(A,X)110-20
CNPH*6124A**	1.02	1.05	58CV(A,X)110-20
CSPH*6012A**	1.00	1.03	58CV(A,X)110-20
CAP**6024A**	0.99	1.02	58CV(A,X)135-22
CAP**6025A**	0.99	1.02	58CV(A,X)135-22
CNPH*6124A**	0.99	1.02	58CV(A,X)135-22
CNPH*6024A**	1.01	1.04	58CV(A,X)135-22
CNPH*6124A**	1.00	1.01	58CV(A,X)135-22
CSPH*6012A**	0.99	1.01	58CV(A,X)135-22
CAP**6024A**	0.99	1.01	58CV(A,X)155-22
CAP**6025A**	0.99	1.01	58CV(A,X)155-22
CNPH*6024A**	0.99	1.01	58CV(A,X)155-22
CNPH*6124A**	0.98	1.00	58CV(A,X)155-22
CNPH*6024A**	1.00	1.02	58CV(A,X)155-22
CNPH*6124A**	1.00	0.99	58CV(A,X)155-22
CSPH*6012A**	0.99	1.00	58CV(A,X)155-22
CAP**6021A**	1.01	1.07	59*N*A080V21**20
CAP**6024A**	1.01	1.07	59*N*A080V21**20
CNPH*6024A**	1.03	1.08	59*N*A080V21**20

HEATING INDOOR MODEL	CAPACITY	POWER	FURNACE MODEL
CNPH*6024A**	1.03	1.08	59*N*A080V21**20
CSPH*6012A**	1.02	1.06	59*N*A080V21**20
CAP**6021A**	1.01	1.06	59*N*A100V21**22
CAP**6024A**	1.01	1.06	59*N*A100V21**22
CNPH*6024A**	1.04	1.08	59*N*A100V21**22
CNPH*6124A**	1.04	1.08	59*N*A100V21**22
CSPH*6012A**	1.02	1.05	59*N*A100V21**22
CAP**6024A**	1.03	1.09	59*N*A120V24**22
CAP**6025A**	1.00	1.07	59*N*A120V24**22
CNPH*6024A**	1.04	1.09	59*N*A120V24**22
CNPH*6124A**	0.99	1.06	59*N*A120V24**22
CNPH*6024A**	1.04	1.09	59*N*A120V24**22
CNPH*6124A**	1.01	1.05	59*N*A120V24**22
CSPH*6012A**	1.04	1.07	59*N*A120V24**22
CAP**6021A**	1.01	1.11	59MN7A060V21**20
CAP**6024A**	1.01	1.11	59MN7A060V21**20
CNPH*6024A**	1.02	1.10	59MN7A060V21**20
CNPH*6124A**	1.02	1.10	59MN7A060V21**20
CSPH*6012A**	1.02	1.10	59MN7A060V21**20
CAP**6021A**	1.01	1.09	58MV(B,C)080-20
CNPH*6024A**	1.01	1.09	58MV(B,C)080-20
CNPH*6124A**	1.00	1.07	58MV(B,C)080-20
CNPH*6024A**	1.00	1.08	58MV(B,C)080-20

HEATING INDOOR MODEL	CAPACITY	POWER	FURNACE MODEL
CNPH*6124A**	1.04	1.09	58MV(B,C)080-20
CSPH*6012A**	1.01	1.08	58MV(B,C)080-20
CAP**6021A**	1.01	1.09	58MV(B,C)100-20
CNPH*6024A**	1.01	1.08	58MV(B,C)100-20
CNPH*6124A**	1.00	1.07	58MV(B,C)100-20
CNPH*6024A**	1.04	1.11	58MV(B,C)100-20
CNPH*6124A**	1.03	1.08	58MV(B,C)100-20
CSPH*6012A**	1.00	1.06	58MV(B,C)100-20
CAP**6024A**	1.00	1.05	58MV(B,C)120-20
CAP**6025A**	1.00	1.05	58MV(B,C)120-20
CNPH*6024A**	1.00	1.05	58MV(B,C)120-20
CNPH*6124A**	1.00	1.05	58MV(B,C)120-20
CNPH*6024A**	1.02	1.07	58MV(B,C)120-20
CNPH*6124A**	1.01	1.04	58MV(B,C)120-20
CSPH*6012A**	1.00	1.04	58MV(B,C)120-20
CAP**6021A**	1.03	1.12	59*N*A100V21**20
CAP**6024A**	1.03	1.11	59*N*A100V21**20
CAP**6025A**	1.02	1.10	59*N*A100V21**20
CNPH*6024A**	1.00	1.08	59*N*A100V21**20
CNPH*6124A**	1.05	1.12	59*N*A100V21**20
CNPH*6024A**	0.99	1.07	59*N*A100V21**20
CNPH*6124A**	1.06	1.12	59*N*A100V21**20
CSPH*6012A**	0.98	1.05	59*N*A100V21**20

* Tested combination.

† The kW values include the compressor, outdoor fan motor, and indoor blower motor. The kW from supplement heaters should be added to these values to obtain total system kilowatts.

‡ The Bluh heating capacity values shown are net integrated values from which the defrost effect has been subtracted. The Bluh heating from supplement heaters should be added to those values to obtain total system capacity.

NOTE: When the required data falls between the published data, interpolation may be performed. Extrapolation is not an acceptable practice.

EDB — Entering Dry Bulb

GUIDE SPECIFICATIONS

GENERAL

System Description

Outdoor-mounted, air-cooled, split-system heat pump unit suitable for ground or rooftop installation. Unit consists of a hermetic compressor, an air-cooled coil, forward-swept blade propeller-type condenser fan, and a control box. Unit will discharge supply air upward as shown on contract drawings. Unit will be used in a refrigeration circuit to match up to a packaged fan coil or coil unit.

Quality Assurance

- Unit will be rated in accordance with the latest edition of AHRI Standard 240.
- Unit will be certified for capacity and efficiency, and listed in the latest AHRI directory.
- Unit construction will comply with latest edition of ASHRAE and with NEC.
- Unit will be constructed in accordance with UL standards and will carry the UL label of approval. Unit will have C-UL approval.
- Unit cabinet will be capable of withstanding Federal Test Method Standard No. 141 (Method 6061) 500-hr salt spray test.
- Air-cooled condenser coils are pressure tested and the outdoor units are leak tested.
- Unit constructed in ISO9001 approved facility.

Delivery, Storage, and Handling

- Unit will be shipped as single package only and is stored and handled per unit manufacturer's recommendations.

Warranty (for inclusion by specifying engineer)

- U.S. and Canada only.

PRODUCTS

Equipment

- Factory-assembled, single-piece, air-cooled heat pump unit. Contained within the unit enclosure is all factory wiring, piping, controls, compressor, refrigerant charge Puron® (R-410A) refrigerant, and special features required prior to field start-up.

Unit Cabinet

- Unit cabinet will be constructed of galvanized steel, bonderized, and coated with a powder coat paint.

Fans

- Condenser fan will be direct-drive propeller type, forward swept blade, discharging air upward.

AIR-COOLED, SPLIT-SYSTEM HEAT PUMP

25VNA

2 TO 5 NOMINAL TONS

- Condenser fan motors will be totally enclosed, 1-phase type with class B insulation and permanently lubricated.
- Shafts will be corrosion resistant.
- Fan blades will be statically and dynamically balanced.
- Condenser fan openings will be equipped with coated steel wire safety guards.

Compressor

- Compressor will be hermetically sealed.
- Compressor will be mounted on rubber vibration isolators.
- Compressor will be covered with a sound absorbing blanket.

Condenser Coil

- Condenser coil will be air cooled.
- Coil will be constructed of aluminum fins mechanically bonded to copper tubes which are then cleaned, dehydrated, and sealed.

Refrigeration Components

- Refrigeration circuit components will include liquid-line front-seating shutoff valve with sweat connections, vapor-line front-seating shutoff valve with sweat connections, system charge of Puron® (R-410A) refrigerant, POE compressor oil, accumulator, charge compensator, electronic expansion valve, and reversing valve.
- Unit will be equipped with high-pressure switch, suction pressure transducer, and filter drier for Puron® refrigerant.

Operating Characteristics

- The capacity of the unit will meet or exceed _____ Btuh at a suction temperature of _____ °F (°C). The power consumption at full load will not exceed _____ kW.
- Combination of the unit and the evaporator or fan coil unit will have a total net cooling capacity of _____ Btuh or greater at conditions of _____ CFM entering air temperature at the evaporator at _____ °F (°C) wet bulb and _____ °F (°C) dry bulb, and air entering the unit at _____ °F (°C).
- The system will have a SEER of _____ Btuh/watt or greater at DOE conditions.

Electrical Requirements

- Nominal unit electrical characteristics will be _____ v, single phase, 60 hz. The unit will be capable of satisfactory operation within voltage limits of _____ v to _____ v.
- Unit electrical power will be single point connection.
- Control circuit will be 24v.

Special Features

- Refer to section of this literature identifying accessories and descriptions for specific features and available enhancements.
- Infinity control with appropriate software version is required for full featured operation.

SYSTEM DESIGN SUMMARY

1. Intended for outdoor installation with free air inlet and outlet. Outdoor fan external static pressure available is less than 0.01-in. wc.
2. This product is qualified for low ambient cooling operation (below 55°F / 12.8°C) with an Infinity User Interface **ONLY**.
3. The maximum outdoor operating ambient in cooling mode is 125°F (51.67°C).
4. Minimum outdoor operating air temperature for heating mode is -15°F (-26.1°C).
5. Maximum outdoor operating air temperature for heating mode is 66°F (18.9°C).
6. For reliable operation, unit should be level in all horizontal planes.
7. For interconnecting refrigerant tube lengths greater than 80 ft (23.4 m) and/or elevation differences between indoor and outdoor units greater than 20 ft (6.1 m), consult Residential Piping and Longline Guideline and Service Manual available from equipment distributor.
8. If any refrigerant tubing is buried, provide a 6 in. (152.4 mm) vertical rise to the valve connections at the unit. Refrigerant tubing lengths up to 36 in. (914.4 mm) may be buried without further consideration. Do not bury refrigerant lines longer than 36 in. (914.4 mm).
9. Use only copper wire for electric connection at unit. Aluminum and clad aluminum are not acceptable for the type of connector provided.
10. Do not apply capillary tube indoor coils to these units.
11. Factory-supplied filter drier must be installed.

25VNA