

50LC WeatherExpert® Series
Ultra High–Efficiency
Single Package Rooftop and Single Zone VAV
Cooling Only with Optional Electric Heat
Sizes 14 – 26 with Puron® (R–410A) Refrigerant
12.5– 23 Ton



Product Data



WeatherExpert®



Unit shown with economizer and power exhaust

C160072

TABLE OF CONTENTS

	PAGE		PAGE
UNIT FEATURES	3	APPLICATION DATA	31
MODEL NUMBER NOMENCLATURE	4	COOLING CAPACITY TABLES	32
FACTORY OPTIONS AND/OR ACCESSORIES	5	STATIC PRESSURE ADDERS	52
AHRI COOLING RATING TABLES	8	ECONO, BARO RELIEF & PE PERFORMANCE ...	53
HEATING MIN/MAX CFM TABLE	9	FAN PERFORMANCE	54
PHYSICAL DATA	10	ELECTRICAL INFORMATION	62
ELECTRIC HEAT DATA	12	WIRING DIAGRAMS	75
UNIT: DIMENSIONS, WEIGHTS & CURBS	17	SEQUENCE OF OPERATION	79
OPTIONS AND ACCESSORY WEIGHTS	30	GUIDE SPECIFICATIONS	83



50LC

Carrier’s new Electric Heat / Electric Cooling and Cooling only WeatherExpert® 12.5 to 23 ton Commercial Package Rooftop models are designed to provide total low cost of ownership by providing some of the highest cooling efficiencies in the industry with low installed costs, low maintenance costs, and high reliability. These models focus on providing high IEERs (Integrated Energy Efficiency Ratios) which are a measurement of cooling part load performance and where actual buildings operate nearly all of the time. These high part load values are achieved by using logic that strategically sequences compressor stages, indoor fan motor and condenser fan motor speeds. These models are in addition to the 3 to 5 ton models with SEERs up to 17.5 and 6 to 10 ton models with IEERs up to 21.0 to provide a full range offering.

Ultra high efficiency:

With IEER’s up to 19.3, these new WeatherExpert models help to contribute in LEED credits and help qualify for rebates. The high IEER efficiencies are achieved by utilizing a proven staged compressor design on a single refrigerant circuit that provides three stages of cooling capacity control. The indoor fan motors are high efficiency belt drive and controlled by a VFD (Variable Frequency Drive) system that matches the cooling capacity stages for optimum comfort and efficient control. Models also have multiple heat capacities.

Easy to install:

Units are designed for dedicated factory-supplied vertical or horizontal air flow duct configuration. No special field kits are required. Designed to fit on pre-installed curbs by another manufacturer, these units also fit on past designed Carrier installed curbs with an authorized adapter curb. The cabinet design also integrates a large control box that gives you room to work and room to mount Carrier accessory controls.

Easy to maintain:

Easy access door handles by Carrier provide quick access to all normally serviced components. Our “no-strip” screw system has superior holding power and guides screws into position while preventing the screw from stripping the unit’s metal. Units come with accessible 2-inch filter that have a dedicate access door for easy replacement. Optional hinged panels allow easy access with pull tabs and quarter turn latches.

Reliability:

Carrier conducts rigorous testing to insure your unit will perform as designed. Extensive rain testing is conducted in special designed test areas and under conditions that simulate actual job sites. In addition, units are both shake tested and driven around the country to make sure not only the packaging holds up, but the unit components within. Condensate pans are made of non corrosive – composite material, motors are permanently lubricated and compressors use crankcase heaters, all to further strengthen the unit’s reliability.



Use of the AHRI Certified TM Mark indicates a manufacturer’s participation in the program For verification of certification for individual products, go to www.ahridirectory.org.

UNIT FEATURES

- Three-stage cooling capacity control with staged scroll compressors design. Each stage is different in capacity output to better match typical building load profiles.
- Single refrigerant circuit design with precision sized TXV refrigerant metering devices to provide optimum operation through the entire operating range.
- Single full faced evaporator coil for full surface utilization, even at part load operation.
- Crankcase heater on each compressor designed to cycle off during the on cycle.
- IEER up to 19.3 and EER's up to 12.6.
- High efficiency permanently lubricated belt driven evaporator-fan motor with VFD (Variable Frequency Drive) controller.
- Electro-Mechanical Integrated Staging Control (ISC) board that provides:
 - Thermostat controls
 - Compressor staging
 - Indoor fan motor staging
 - Field and factory wiring connections
 - Outdoor fan motor staging
 - Crank case heater control
- Sound levels as low as 84 dB.
- Exclusive non-corrosive composite condensate pan in accordance with ASHRAE 62 Standard, sloping design; side or bottom drain.
- Single point electrical connections
- Pre-painted exterior panels and primer-coated interior panels tested to 500 hours salt spray protection.
- Fully insulated with foil faced insulation throughout the entire cabinet.
- High ambient cooling operation and ratings up to 125°F (52°C).
- Low ambient mechanical cooling operation down to 40°F (4°C). An economizer shall be the source of cooling in low ambient temperature conditions. When the outside air temperature is below 40°F (4°C), to reduce operating costs, mechanical cooling shall not be utilized.
- Access panels with easy grip handles.
- Innovative, easy starting, no-strip screw feature on unit access panels.
- Two-inch disposable return air filters.
- Tool-less filter access door.
- Dedicated vertical and horizontal airflow models available ordered as factory option. No special kits required.
- Provisions for thru-the-bottom power entry capability as standard.
- Full perimeter base rail with built-in rigging adapters and fork truck slots.
- 24-volt control circuit protected with resettable circuit breaker.
- Totally enclosed high-efficiency ECM outdoor fan motor with permanently lubricated bearings.
- Low-pressure switch and high-pressure switch protection.
- High capacity liquid line filter drier.
- Factory-installed Humidi-MiZer[®] Adaptive Dehumidification System on all sizes.
- Factory-installed SystemVu[™] controller with LCD user display
- Standard Limited Parts Warranty: 5 yr. electric heat, 5 yr. compressor, 3 yr. SystemVu controller, 1 yr. parts.

MODEL NUMBER NOMENCLATURE

1	2	3	4	5	6	7	8	9	10	11	12	13	14	15	16	17	18
5	0	L	C	D	0	2	4	A	2	A	5	-	0	A	0	A	0

Unit Type

50 = Electric Cooling
Packaged Rooftop

Model Series – WeatherExpert

LC = Ultra High Efficiency

Heat Size

0 = Standard No Electric Heat
D = Low Electric Heat
E = Medium Electric Heat
F = High Electric Heat

Refrig. System Options

0 = Three-stage cooling capacity control with TXV
A = Three-stage cooling capacity control with TXV
and Humidi-MiZer®

Nominal Cooling Tons

14 = 12.5 Ton
17 = 15 Ton
20 = 17.5 Ton
24 = 20 Ton
26 = 23 Ton

Sensor Options

A = None
B = RA smoke detector
C = SA smoke detector
D = RA & SA smoke detector
E = CO₂ sensor
F = RA smoke detector & CO₂
G = SA smoke detector & CO₂
H = RA & SA smoke detector & CO₂

Indoor Fan Options

1 = Standard Static Vertical Supply Return Air Flow
2 = Medium Static Vertical Supply Return Air Flow
3 = High Static Vertical Supply Return Air Flow
4 = Ultra High Static Vertical Supply Return Air Flow
5 = Standard Static Horizontal supply Return Air Flow
6 = Medium Static Horizontal supply Return Air Flow
7 = High Static Horizontal supply Return Air Flow
8 = Ultra High Static Horizontal supply Return Air Flow

* SystemVu controller is not available on units equipped with Standard Leak Economizers or Humidi-MiZer system.

Not all possible options can be displayed above – see Price Pages for more details.

Brand / Packaging

0 = Standard
1 = LTL

Electrical Options

A = None
B = HACR breaker
C = Non-fused disconnect

Service Options

0 = None
1 = Unpowered convenience outlet
2 = Powered convenience outlet
3 = Hinged panels
4 = Hinged panels, unpwr'd conv outlet
5 = Hinged panels, pwr'd conv outlet

Air Intake / Exhaust Options

A = None
B = Temp Standard Leak Econo w/Baro relief
C = Temp Standard Leak Econo w/PE(cent) – Vertical Only
E = Enthalpy Standard Leak Econo w/Baro relief
F = Enthalpy Standard Leak Econo w/PE(cent) – Vertical Only
N = Temp Ultra Low Leak Econo w/ baro relief
P = Temp Ultra Low Leak Econo w/PE vert only
R = Enthalpy Ultra Low Leak Econo w/ baro relief
S = Enthalpy Ultra Low Leak Econo w/PE (cent) – Vertical Only

Base Unit Controls

0 = Electro-Mechanical Control
1 = RTU Open Multi=Protocol Controller
4 = SystemVu™ Controller*

Design Revision

– Factory design revision

Voltage

1 = 575/3/60
5 = 208–230/3/60
6 = 460/3/60

Coil Options (Outdoor–Indoor–Hailguard)

A = Al/Cu – Al/Cu
B = Precoat Al/Cu – Al/Cu
C = E coat Al/Cu – Al/Cu
D = E coat Al/Cu – E coat Al/Cu
E = Cu/Cu – Al/Cu
F = Cu/Cu – Cu/Cu
M = Al/Cu – Al/Cu – Louvered Hail Guard
N = Precoat Al/Cu – Al/Cu – Louvered Hail Guard
P = E-coat Al/Cu – Al/Cu – Louvered Hail Guard
Q = E-coat Al/Cu – E-coat Al/Cu – Louvered Hail Guard
R = Cu/Cu – Al/Cu – Louvered Hail Guard
S = Cu/Cu – Cu/Cu – Louvered Hail Guard

Table 1 – FACTORY-INSTALLED OPTIONS AND FIELD-INSTALLED ACCESSORIES

CATEGORY	ITEM	FACTORY-INSTALLED OPTION	FIELD-INSTALLED ACCESSORY
Cabinet	Hinged access panels	X	
Coil Options	Cu/Cu indoor and/or outdoor coils	X	
	Pre-coated outdoor coils	X	
	Premium, E-coated outdoor coils	X	
Humidity Control	Humidi-MiZer [®] Adaptive Dehumidification System	X	
Condenser Protection	Condenser coil hail guard (louvered design)	X	X
Controls	Thermostats, temperature sensors, and subbases		X
	Smoke detector (supply and/or return air)	X	X
	Horn/Strobe Annunciator ⁸		X
	Time Guard II compressor delay control circuit		X
	Phase Monitor		X
	SystemVu™ Controller ⁷	X	
Economizers & Outdoor Air Dampers	EconoMi\$er X for electromechanical controls, complies with FDD. (Standard and Ultra Low Leak air damper models) ⁶	X	X
	EconoMi\$er 2 for DDC controls, complies with FDD. (Standard and Ultra Low Leak air damper models) ⁶	X	X
	Barometric relief ¹	X	X
	Power exhaust	X	X
Economizer Sensors & IAQ Devices	Single dry bulb temperature sensors ²	X	X
	Differential dry bulb temperature sensors ²		X
	Single enthalpy sensors ²	X	X
	Differential enthalpy sensors ²		X
	CO ₂ sensor (wall, duct, or unit mounted) ²	X	X
Electric Heat	Electric Resistance Heaters	X	X
	Single Point Kit	X	X
Indoor Motor & Drive	Multiple motor and drive packages	X	
Power Options	Convenience outlet (powered)	X	
	Convenience outlet (unpowered)	X	
	HACR circuit breaker ^{3, 5}	X	
	Non-fused disconnect ^{4,5}	X	
Roof Curbs	Roof curb 14-in (356 mm)		X
	Roof curb 24-in (610 mm)		X

NOTES:

- 1 Included with economizer.
- 2 Sensors used to optimize economizer performance.
- 3 On 575V applications, HACR breaker can only be used with WYE power distribution systems. Using on Delta power distribution systems is prohibited.
- 4 On 208/230-460 units with FIOP Non-Fused Disconnect, and Single Point Box accessory may be required. Refer to Electric Heat-Electrical Data Table for more information.
- 5 When selecting a factory installed HACR breaker or non-fused disconnect, note they are sized for the unit as ordered from the factory. The sizing of these do not accommodate any field items such as power exhaust devices etc.
- 6 FDD (Fault Detection and Diagnostic) capability per California Title 24 section 120.2.
- 7 SystemVu controller is not available on units equipped with Standard Leak Economizers or Humidi-MiZer system.
- 8 Requires a field-supplied 24V transformer for each application. See price pages for details.

FACTORY OPTIONS AND/OR ACCESSORIES

Economizer

Economizers can reduce operating costs. They bring in fresh, outside air for ventilation; and provide cool outside air to cool your building. This also is the preferred method of low ambient cooling. When coupled to CO₂ sensors, economizers can limit the ventilation air to only that amount required.

Economizers are available, installed and tested by the factory, with either enthalpy or temperature dry-bulb

inputs. There are also models for electromechanical and direct digital controllers. Additional sensors are available as accessories to optimize the economizer.

Economizers include gravity controlled barometric relief that helps equalize building pressure and ambient air pressures. This can be a cost effective solution to prevent building pressurization. Economizers are available in Ultra Low Leak and standard low leak versions.

FACTORY OPTIONS AND/OR ACCESSORIES (cont.)

CO₂ Sensor

The CO₂ sensor works with the economizer to intake only the correct amount of outside air for ventilation. As occupants fill your building, the CO₂ sensor detects their presence through increasing CO₂ levels, and opens the economizer appropriately.

When the occupants leave, the CO₂ levels decrease, and the sensor appropriately closes the economizer. This intelligent control of the ventilation air, called Demand Controlled Ventilation (DCV) reduces the overall load on the rooftop, saving money.

Smoke Detectors

Trust the experts. Smoke detectors make your application safer and your job easier. Carrier smoke detectors immediately shut down the rooftop unit when smoke is detected. They are available, installed by the factory, for supply air, return air, or both.

Louvered Hail Guards

Sleek, louvered panels protect the condenser coil from hail damage, foreign objects, and incidental contact.

Convenience Outlet (powered or un-powered)

Reduce service and/or installation costs by including a convenience outlet in your specification. Carrier will install this service feature at our factory. Provides a convenient, 15 amp, 115v GFCI receptacle with “Wet in Use” cover. The “powered” option allows the installer to power the outlet from the line side of the disconnect or load side as required by code. The “unpowered” option is to be powered from a separate 115/120v power source.

Non-fused Disconnect

This OSHA-compliant, factory-installed, safety switch allows a service technician to locally secure power to the rooftop.

When selecting a factory-installed non-fused disconnect, note they are sized for the unit as ordered from the factory. The sizing of these do not accommodate any field items such as power exhaust devices etc.

Power Exhaust

Superior internal building pressure control. This field-installed accessory may eliminate the need for costly, external pressure control fans.

Time Guard II Control Circuit

This accessory protects your compressor by preventing short-cycling in the event of some other failure, prevents the compressor from restarting for 30 seconds after stopping. Not required if built into thermostat or building management system.

Hinged Access Panels

Allows access to unit's major components with specifically designed hinged access panels. Panels are: filter, control box, fan motor and compressor. Comes with quarter turn latches and lift tabs.

Alternate Motors and Drives

Some applications need larger horsepower motors, some need more airflow, and some need both. Regardless of the case, your Carrier expert has a factory-installed combination to meet your application. A wide selection of motors and pulleys (drives) are available, factory installed, to handle nearly any application.

Thru-the-Bottom Connections

Provisions for thru-the-bottom power connections are standard.

Electric Heaters

Carrier offers a full-line of field-installed accessory heaters. The heaters are very easy to use, install and are all pre-engineered and certified.

HACR Breaker

These manual reset devices provide overload and short circuit protection for the unit. Factory wired and mounted with the units with access cover to help provide environment protection.

When selecting a factory installed HACR breaker, note they are sized for the unit as ordered from the factory. The sizing of these do not accommodate any field items such as power exhaust devices etc.

On 575V applications, HACR breaker can only be used with WYE power distribution systems. Use on Delta power distribution systems is prohibited.

Thermostat

Due to the three-stage cooling capacity design of these units, a three-stage cooling thermostat is required for the unit to perform at listed operating efficiencies.

Carrier offers a Honeywell branded T7350D (3 Cool/3 Heat) Commercial Programmable Thermostat.

This provides:

- 7-day programmable
- 365-day clock with holiday programming
- Automatic Daylight Saving Time adjustment
- Backlit display
- Changeover selections: automatic or manual
- Fan configurable: continuous or intermittent during occupied

FACTORY OPTIONS AND/OR ACCESSORIES (cont.)

SystemVu™ Controller

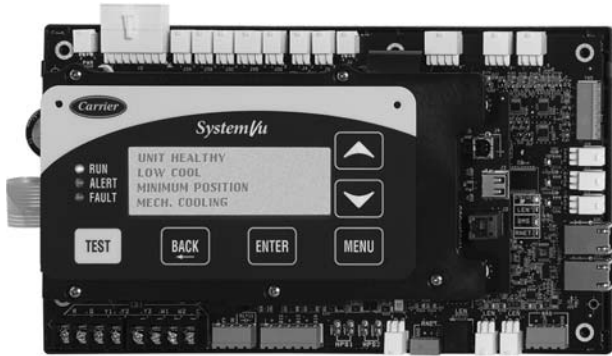

C150174



BACnet is a registered trademark of ASHRAE. ASHRAE does not endorse, approve or test products for compliance with ASHRAE standards. Compliance of listed products to the requirements of ASHRAE Standard 135 is the responsibility of BACnet International (BI). BTL is a registered trademark of BI.

Carrier's new SystemVu™ unit controller is an optional factory installed and tested controller designed specifically for use in the WeatherExpert® rooftop units.

This new controller takes on a whole new approach to provide an intuitive, intelligent controller that not only monitors and controls the unit, but also provides linkage to multiple building automation systems.

Each SystemVu controller makes it easy to set up, service, troubleshoot, gain historical data, generate reports and provide comfort only Carrier is noted for.

Some of the key features include:

- Easy to read back lit four line text screen for superior visibility.
- Quick operational condition LED's of: Run, Alert, and Fault.
- Simple navigation with large keypad buttons of: Navigation arrows, Test, Back, Enter and Menu.
- Capable of being controlled with a conventional thermostat, space sensor or building automation systems.
- Service Capabilities Include:
 - Auto run test
 - Manual run test
 - Component run hours and starts
 - Commissioning reports
 - Data logging

- Full Range of Diagnosis:
 - Read refrigerant pressures without the need of gauges
 - Sensor faults
 - Compressor reverse rotation
 - Economizer diagnostics that meets California Title 24 requirements
- Quick data transfer via USB port:
 - Unit configuration uploading/downloading
 - Data logging
 - Software upgrades
- Built in capability for:
 - i-Vu® open systems
 - BACnet* systems
 - CCN systems
- Configuration and alarms point capability
 - Contain over 100 alarm codes
 - Contain over 300 status, troubleshooting, diagnostic and maintenance points
 - Contain over 300 control configuration setpoints

NOTE: SystemVu controller is not available on units equipped with Standard Leak Economizers or Humidi-MiZer® system.

* BACnet is a registered trademark of ASHRAE (American Society of Heating, Refrigerating and Air-Conditioning Engineers)

Optional Humidi-MiZer® Adaptive Dehumidification System

Carrier's Humidi-MiZer adaptive dehumidification system is an all-inclusive factory installed option that can be ordered with any 48LC WeatherExpert® rooftop unit, except for units equipped with SystemVu™ controls.

This system expands the envelope of operation of Carrier's WeatherExpert rooftop products to provide unprecedented flexibility to meet year round comfort conditions.

The Humidi-MiZer adaptive dehumidification system has a unique dual operational mode setting. The Humidi-MiZer system provides greater dehumidification of the occupied space by two modes of dehumidification operations in addition to its normal design cooling mode.

The 50LC WeatherExpert rooftop coupled with the Humidi-MiZer system is capable of operating in normal design cooling mode, subcooling mode, and hot gas reheat mode. Normal design cooling mode is when the unit will operate under its normal sequence of operation by cycling compressors to maintain comfort conditions.

Subcooling mode will operate to satisfy part load type conditions when the space requires combined sensible and a higher proportion of latent load control. Hot Gas Reheat mode will operate when outdoor temperatures diminish and the need for latent capacity is required for sole humidity control. Hot Gas Reheat mode will provide neutral air for maximum dehumidification operation.

Table 2 – AHRI COOLING RATING TABLE

208V — VERTICAL AIR FLOW

LC SIZE	COOLING STAGES	NOMINAL CAPACITY (Tons)	NET COOLING CAPACITY (MBH)	TOTAL POWER (kW)	ELECTRIC HEAT OPTION	INDOOR MOTOR OPTION (Static Capability)	EER	IEER
14	3	12.5	146.0	11.6	None	Std, High, Ultra High	12.6	19.3
				11.7	None	Med	12.5	19.2
				11.7	Low, Med, High	Std, High, Ultra High	12.4	19.2
				11.8	Low, Med, High	Med	12.4	19.1
17	3	15.0	172.0	13.7	None, Low, Med, High	Std, Med, High, Ultra High	12.6	18.5
20	3	17.5	194.0	15.9	None, Low, Med, High	Std, Med, High, Ultra High	12.2	17.9
24	3	20.0	232.0	19.0	None, Low, Med, High	Std, Med, High, Ultra High	12.2	18.2
26	3	23.0	274.0	23.6	None, Low, Med, High	Std, Med, High	11.6	18.3

See "LEGEND AND NOTES FOR TABLES 2 – 5" on page 9.

Table 3 – AHRI COOLING RATING TABLE

230/460/575V — VERTICAL AIR FLOW

LC SIZE	COOLING STAGES	NOMINAL CAPACITY (Tons)	NET COOLING CAPACITY (MBH)	TOTAL POWER (kW)	ELECTRIC HEAT OPTION	INDOOR MOTOR OPTION (Static Capability)	EER	IEER
14	3	12.5	146.0	11.6	None	Std, High, Ultra High	12.6	19.3
				11.7	None	Med	12.5	19.2
				11.7	Low, Med, High	Std, High, Ultra High	12.4	19.2
				11.8	Low, Med, High	Med	12.4	19.1
17	3	15.0	174.0	13.8	All	Std, Med, High, Ultra High	12.6	18.5
20	3	17.5	194.0	15.9	All	Std, Med, High, Ultra High	12.2	17.7
24	3	20.0	234.0	19.2	All	Std, Med, High, Ultra High	12.2	18.2
26	3	23.0	274.0	23.6	All	Std, Med, High	11.6	18.3

See "LEGEND AND NOTES FOR TABLES 2 – 5" on page 9.

Table 4 – AHRI COOLING RATING TABLE

208V — HORIZONTAL AIR FLOW

LC SIZE	COOLING STAGES	NOMINAL CAPACITY (Tons)	NET COOLING CAPACITY (MBH)	TOTAL POWER (kW)	ELECTRIC HEAT OPTION	INDOOR MOTOR OPTION (Static Capability)	EER	IEER
14	3	12.5	146.0	12.0	None	Std, High, Ultra High	12.2	18.7
				12.2	None	Med	12.0	18.5
				12.3	Low, Med, High	Std, High, Ultra High	11.9	18.3
				12.4	Low, Med, High	Med	11.8	18.2
17	3	15.0	170.0	14.0	None, Low, Med	Std, Med, High, Ultra High	12.1	17.7
				14.3	High	Std, Med, High, Ultra High	11.9	17.5
20	3	17.5	192.0	16.7	None, Low	Std, Med, High, Ultra High	11.5	17.2
				16.8	Med	Std, Med, High, Ultra High	11.4	17.1
				17.0	High	Std, Med, High, Ultra High	11.3	17.0
24	3	20.0	230.0	20.2	None, Low, Med	Std, Med, High, Ultra High	11.4	17.5
			228.0	20.4	High	Std, Med, High, Ultra High	11.2	17.4
26	3	23.0	270.0	25.5	None, Low	Std, Med, High	10.6	16.8
			268.0	25.3	Med	Std, Med, High	10.6	16.8
			268.0	25.8	High	Std, Med, High	10.4	16.5

See "LEGEND AND NOTES FOR TABLES 2 – 5" on page 9.

Table 5 – AHRI COOLING RATING TABLE

230/460/575V — HORIZONTAL AIR FLOW

LC SIZE	COOLING STAGES	NOMINAL CAPACITY (Tons)	NET COOLING CAPACITY (MBH)	TOTAL POWER (kW)	ELECTRIC HEAT OPTION	INDOOR MOTOR OPTION (Static Capability)	EER	IEER
14	3	12.5	146.0	12.0	None	Std, High, Ultra High	12.2	18.7
				12.2	None	Med	12.0	18.5
				12.3	Low, Med, High	Std, High, Ultra High	11.9	18.3
				12.4	Low, Med, High	Med	11.8	18.2
17	3	15.0	172.0	14.2	None, Low, Med	Std, Med, High, Ultra High	12.1	17.7
				14.5	High	Std, Med, High, Ultra High	11.9	17.5
20	3	17.5	192.0	16.7	None, Low	Std, Med, High, Ultra High	11.5	17.0
				16.8	Med	Std, Med, High, Ultra High	11.4	16.9
				17.0	High	Std, Med, High, Ultra High	11.3	16.8
24	3	20.0	232.0	20.4	None, Low, Med	Std, Med, High, Ultra High	11.4	17.5
			207.0	20.7	High	Std, Med, High, Ultra High	11.2	17.4
26	3	23.0	270.0	25.5	None, Low	Std, Med, High	10.6	16.8
			268.0	25.3	Med	Std, Med, High	10.6	16.8
			268.0	25.8	High	Std, Med, High	10.4	16.5

See "LEGEND AND NOTES FOR TABLES 2 – 5" on page 9.

LEGEND AND NOTES FOR TABLES 2 – 5

- AHRI – Air-Conditioning, Heating and Refrigeration Institute Test Standard
- ASHRAE – American Society of Heating, Refrigerating and Air-Conditioning Engineers
- EER – Energy Efficiency Ratio
- IEER – Integrated Energy Efficiency Ratio

NOTES:

- 1 Rated in accordance with AHRI Standards.
- 2 Ratings are based on:
Cooling Standard: 80°F (27°C) db, 67°F (19°C) wb indoor air temp and 95°F (35°C) db outdoor air temp.
- 3 50LC units comply with US Energy Policy Act. To evaluate code compliance requirements, refer to state and local codes.

Table 6 – COOLING MINIMUM - MAXIMUM AIRFLOW RATINGS

LC SIZE	COOLING STAGE	MAX CFM	MIN CFM	MAX OD AMBIENT TEMPERATURE °F	MIN OD AMBIENT TEMPERATURE °F
14	Stage-3	6250	3150	125°	40°
	Stage-2	3750	1900		
	Stage-1	2500	1250		
17	Stage-3	7500	3750	125°	40°
	Stage-2	4500	2250		
	Stage-1	3000	1500		
20	Stage-3	8750	4400	125°	40°
	Stage-2	5400	2700		
	Stage-1	4600	2300		
24	Stage-3	10000	5000	125°	40°
	Stage-2	5700	2850		
	Stage-1	4300	2150		
26	Stage-3	11250	5650	125°	40°
	Stage-2	8100	4050		
	Stage-1	6750	3400		

NOTE: SystemVu™ controller provides minimum outdoor temperature operation down to 0°F (-18°C).

Table 7 – HEATING MINIMUM / MAXIMUM CFM TABLE

UNIT	MIN AIR FLOW (CFM)	MAX AIR FLOW (CFM)
50LC**14	3,750	6,250
50LC**17	4,500	7,500
50LC**20	5,250	8,750
50LC**24	6,000	10,000
50LC**26	6,750	11,250

Table 8 – SOUND PERFORMANCE TABLE

50LC	Cooling Stages	OUTDOOR SOUND (dB) AT 60 Hz									
		A-Weighted	31.5	63	125	250	500	1000	2000	4000	8000
14	3	84	92.6	92.2	83.9	80.4	81.8	78.7	76.5	72.2	65.4
17	3	86	101.3	97.1	88.3	84.4	83.3	80.7	77.4	73.4	67.3
20	3	86	101.3	97.1	88.3	84.4	83.3	80.7	77.4	73.4	67.3
24	3	86	101.3	97.1	88.3	84.4	83.3	80.7	77.4	73.4	67.3
26	3	86	101.3	97.1	88.3	84.4	83.3	80.7	77.4	73.4	67.3

LEGEND

dB – Decibel

NOTES:

- 1 Outdoor sound data is measured in accordance with AHRI standard 270.
- 2 Measurements are expressed in terms of sound power. Do not compare these values to sound pressure values because sound pressure depends on specific environmental factors which normally do not match individual applications. Sound power values are independent of the environment and therefore more accurate.
- 3 A-weighted sound ratings filter out very high and very low frequencies, to better approximate the response of "average" human ear. A-weighted measurements for Carrier units are taken in accordance with AHRI standard 270.

Table 9 – PHYSICAL DATA

(COOLING)

12.5-23 TONS

		50LC*14	50LC*17	50LC*20	50LC*24	50LC*26
Refrigeration System						
	# Circuits / # Comp. / Type	1 / 2 / Scroll	1 / 2 / Scroll	1/2/Scroll	1 / 2 / Scroll	1 / 2 / Scroll
	R-410A charge (lbs – oz)	32-0	33-6	35-6	40-10	43-4
	Alternate (Humidi-MiZer®) R-410A charge (lbs – oz)	40-0	50-7	49-0	57-7	54-0
	Metering device	TXV	TXV	TXV	TXV	TXV
	High – press. Trip / Reset (psig)	630 / 505	630 / 505	630 / 505	630 / 505	630 / 505
	Low – press. Trip / Reset (psig)	54 / 117	54 / 117	54 / 117	54 / 117	54 / 117
Evap. Coil						
	Material	Cu / Al	Cu / Al	Cu / Al	Cu / Al	Cu / Al
	Coil type	5/16" RTPF	5/16" RTPF	5/16" RTPF	5/16" RTPF	5/16" RTPF
	Coil Length (in)	72	72	72	72	72
	Coil Height (in)	44	52	52	52	52
	Rows / FPI	4 / 15	4 / 15	4 / 15	4 / 15	4 / 15
	Total Face Area (ft ²)	22.0	26.0	26.0	26.0	26.0
	Condensate drain conn. size	3/4"	3/4"	3/4"	3/4"	3/4"
Humidi-MiZer Coil						
	Material	Cu / Al	Cu / Al	Cu / Al	Cu / Al	Cu / Al
	Coil type	5/16" RTPF	5/16" RTPF	5/16" RTPF	5/16" RTPF	5/16" RTPF
	Coil Length (in)	72	72	72	72	72
	Coil Height (in)	44	52	52	52	52
	Rows / FPI	1 / 18	1 / 18	2 / 18	3 / 18	4 / 18
	Total Face Area (ft ²)	22.0	26.0	26.0	26.0	26.0
Evap. fan and motor						
VERTICAL						
Standard Static	Motor Qty / Belt Qty / Drive Type	1 / 1 / Belt	1 / 1 / Belt	1 / 1 / Belt	1 / 1 / Belt	1 / 1 / Belt
	Max BHP	2.9	2.9	2.9	7.4	7.4
	RPM range	498-676	498-676	555-753	583-717	651-818
	Motor Frame Size	56	56	56HZ	184T	184T
	Fan Qty / Type	2 / Centrifugal	2 / Centrifugal	2 / Centrifugal	2 / Centrifugal	2 / Centrifugal
	Fan Diameter (in)	15 x 15 / 15 x 15	15 x 15 / 15 x 15	15 x 15 / 15 x 15	15 x 15 / 15 x 15	15 x 15 / 15 x 15
Medium Static	Motor Qty / Belt Qty / Drive Type	1 / 1 / Belt	1 / 1 / Belt	1 / 1 / Belt	1 / 1 / Belt	1 / 1 / Belt
	Max BHP	4.9	7.4	7.4	7.4	9.9
	RPM range	682-861	651-818	707-888	707-888	804-970
	Motor Frame Size	145TZ	184T	184T	184T	213T
	Fan Qty / Type	2 / Centrifugal	2 / Centrifugal	2 / Centrifugal	2 / Centrifugal	2 / Centrifugal
	Fan Diameter (in)	15 x 15 / 15 x 15	15 x 15 / 15 x 15	15 x 15 / 15 x 15	15 x 15 / 15x 15	15 x 15 / 15 x 15
High Static	Motor Qty / Belt Qty / Drive Type	1 / 1 / Belt	1 / 1 / Belt	1 / 1 / Belt	1 / 1 / Belt	1 / 2 / Belt
	Max BHP	7.4	9.9	9.9	9.9	13.6
	RPM range	782-963	804-970	872-1053	872-1053	948-1190
	Motor Frame Size	184T	213T	213T	213T	215T
	Fan Qty / Type	2 / Centrifugal	2 / Centrifugal	2 / Centrifugal	2 / Centrifugal	2 / Centrifugal
	Fan Diameter (in)	15 x 15 / 15 x 15	15 x 15 / 15 x 15	15 x 15 / 15 x 15	15 x 15 / 15 x 15	15 x 15 / 15 x 15
Ultra High Static	Motor Qty / Belt Qty / Drive Type	1 / 1 / Belt	1 / 2 / Belt	1 / 2 / Belt	1 / 2 / Belt	N/A
	Max BHP (208/230/460/575v)	9.9	13.6	13.6	13.6	N/A
	RPM range	933-1113	948-1190	948-1190	1049-1291	N/A
	Motor Frame Size	213T	215T	215T	215T	N/A
	Fan Qty / Type	2 / Centrifugal	2 / Centrifugal	2 / Centrifugal	2 / Centrifugal	N/A
	Fan Diameter (in)	15 x 15 / 15 x 15	15 x 15 / 15 x 15	15 x 15 / 15 x 15	15 x 15 / 15 x 15	N/A

Table 9 (cont.) - PHYSICAL DATA

(COOLING)

12.5 - 23 TONS

		50LC*14	50LC*17	50LC*20	50LC*24	50LC*26
Evap. fan and motor (cont.)						
HORIZONTAL						
Standard Static	Motor Qty / Belt Qty / Drive Type	1 / 1 / Belt	1 / 1 / Belt	1 / 1 / Belt	1 / 1 / Belt	1 / 1 / Belt
	Max BHP	2.9	2.9	2.9	7.4	7.4
	RPM range	498-676	498-676	555-753	583-717	707-888
	Motor Frame Size	56	56	56HZ	184T	184T
	Fan Qty / Type	2 / Centrifugal	2 / Centrifugal	2 / Centrifugal	2 / Centrifugal	2 / Centrifugal
	Fan Diameter (in)	18 x 15 / 15 X 11	18 x 15 / 15 X 11	18 x 15 / 15 X 11	18 x 15 / 15 X 11	18 x 15 / 15 X 11
Medium Static	Motor Qty / Belt Qty / Drive Type	1 / 1 / Belt	1 / 1 / Belt	1 / 1 / Belt	1 / 1 / Belt	1 / 1 / Belt
	Max BHP	4.9	7.4	7.4	7.4	9.9
	RPM range	644-808	651-818	651-818	707-888	859-1026
	Motor Frame Size	184T	213T	213T	213T	213T
	Fan Qty / Type	2 / Centrifugal	2 / Centrifugal	2 / Centrifugal	2 / Centrifugal	2 / Centrifugal
	Fan Diameter (in)	18 x 15 / 15 X 11	18 x 15 / 15 X 11	18 x 15 / 15 X 11	18 x 15 / 15 X 11	18 x 15 / 15 X 11
High Static	Motor Qty / Belt Qty / Drive Type	1 / 1 / Belt	1 / 1 / Belt	1 / 1 / Belt	1 / 1 / Belt	1 / 2 / Belt
	Max BHP	7.4	9.9	9.9	9.9	13.6
	RPM range	707-888	804-970	804-970	872-1053	948-1190
	Motor Frame Size	184T	213T	213T	213T	215T
	Fan Qty / Type	2 / Centrifugal	2 / Centrifugal	2 / Centrifugal	2 / Centrifugal	2 / Centrifugal
	Fan Diameter (in)	18 x 15 / 15 X 11	18 x 15 / 15 X 11	18 x 15 / 15 X 11	18 x 15 / 15 X 11	18 x 15 / 15 X 11
Ultra High Static	Motor Qty / Belt Qty / Drive Type	1 / 1 / Belt	1 / 2 / Belt	1 / 2 / Belt	1 / 2 / Belt	N/A
	Max BHP (208/230/460/575v)	9.9	13.6	13.6	13.6	N/A
	RPM range	872-1053	948-1190	948-1190	948-1190	N/A
	Motor frame size	213T	215T	215T	215T	N/A
	Fan Qty / Type	2 / Centrifugal	2 / Centrifugal	2 / Centrifugal	2 / Centrifugal	N/A
	Fan Diameter (in)	18 x 15 / 15 X 11	18 x 15 / 15 X 11	18 x 15 / 15 X 11	18 x 15 / 15 X 11	N/A
Cond. Coil 1						
	Material	Cu / Al	Cu / Al	Cu / Al	Cu / Al	Cu / Al
	Coil type	5/16" RTPF	5/16" RTPF	5/16" RTPF	5/16" RTPF	5/16" RTPF
	Coil Length (in)	68	82	82	98	98
	Coil Height (in)	44	52	52	52	52
	Rows / FPI	2 / 18	2 / 18	2 / 18	2 / 18	2 / 18
	Total Face Area (ft2)	20.8	29.6	29.6	35.4	35.4
Cond. Coil 2						
	Material	Cu / Al	Cu / Al	Cu / Al	Cu / Al	Cu / Al
	Coil type	5/16" RTPF	5/16" RTPF	5/16" RTPF	5/16" RTPF	5/16" RTPF
	Coil Length (in)	68	82	82	98	98
	Coil Height (in)	44	52	52	52	52
	Rows / FPI	2 / 18	2 / 18	2 / 18	2 / 18	2 / 18
	Total Face Area (ft2)	20.8	29.6	29.6	35.4	35.4
Cond. fan / motor						
	Qty / Motor drive type	3 / direct	4 / direct	4 / direct	6 / direct	6 / Direct
	Motor HP / RPM	1/3 / 1000	1/3 / 1000	1/3 /1000	1/3 / 1000	1/3 /1000
	Fan diameter (in)	22	22	22	22	22
Filters						
	RA Filter # / size (in)	6 / 20 x 25 x 2	9 / 16 x 25 x 2	9 / 16 x 25 x 2	9 / 16 x 25 x 2	9 / 16 x 25 x 2
	OA inlet screen # / size (in)	4 / 16 x 25 x 1	4 / 16 x 25 x 1	4 / 16 x 25 x 1	4 / 16 x 25 x 1	4 / 16 x 25 x 1

UNIT 50LC	NOM. V–Ph–Hz	IFM TYPE	ELECTRIC HEATER PART NUMBER CRHEATER***A00 VERT/HORZ	NOM PWR (kW)	APP PWR (kW)	SINGLE POINT KIT PART NUMBER CRSINGLEXXXXA00			
						NO C.O. or UNPWRD C.O.		w/PWRD C.O.	
						NO P.E.	w/ P.E. (pwrd fr/unit)	NO P.E.	w/ P.E. (pwrd fr/unit)
14	208/ 230–3–60	STD	302/305A00	15.0	11.3/13.8	–	–	–	–
			279/270A00	25.0	18.8/23.0	–	–	–	–
			309/312A00	50.0	37.6/45.9	056	056	056	056
		MED	302/305A00	15.0	11.3/13.8	–	–	–	–
			279/270A00	25.0	18.8/23.0	–	–	–	–
			309/312A00	50.0	37.6/45.9	056	056	056	056
		HIGH	302/305A00	15.0	11.3/13.8	–	–	–	–
			279/270A00	25.0	18.8/23.0	–	–	–	–
			309/312A00	50.0	37.6/45.9	056	056	056	056
		ULTRA HIGH	302/305A00	15.0	11.3/13.8	–	–	–	–
			279/270A00	25.0	18.8/23.0	–	–	–	056
			309/312A00	50.0	37.6/45.9	056	056	056	056
	460–3–60	STD	303/306A00	15.0	13.8	–	–	–	–
			282/273A00	25.0	23.0	–	–	–	–
			310/313A00	50.0	45.9	–	057	057	057
		MED	303/306A00	15.0	13.8	–	–	–	–
			282/273A00	25.0	23.0	–	–	–	–
			310/313A00	50.0	45.9	057	057	057	057
		HIGH	303/306A00	15.0	13.8	–	–	–	–
			282/273A00	25.0	23.0	–	–	–	–
			310/313A00	50.0	45.9	057	057	057	057
		ULTRA HIGH	303/306A00	15.0	13.8	–	–	–	–
			282/273A00	25.0	23.0	–	–	–	–
			310/313A00	50.0	45.9	057	057	057	057
575–3–60	STD	304/307A00	15.0	13.8	–	–	–	–	
		285/276A00	24.8	22.8	–	–	–	–	
		311/314A00	49.6	45.6	–	057	–	057	
	MED	304/307A00	15.0	13.8	–	–	–	–	
		285/276A00	24.8	22.8	–	–	–	–	
		311/314A00	49.6	45.6	–	057	–	057	
	HIGH	304/307A00	15.0	13.8	–	–	–	–	
		285/276A00	24.8	22.8	–	–	–	–	
		311/314A00	49.6	45.6	–	057	057	057	
	ULTRA HIGH	304/307A00	15.0	13.8	–	–	–	–	
		285/276A00	24.8	22.8	–	–	–	–	
		311/314A00	49.6	45.6	057	057	057	057	

LEGEND

- APP PWR – 208 / 230V / 460V / 575V
- C.O. – Convenience outlet
- IFM – Indoor fan motor
- NOM PWR – 240V / 480V / 600V
- P.E. – Power exhaust
- Pwr fr/unit – Powered from unit
- PWRD – Powered convenience outlet
- UNPWRD – Unpowered convenience outlet

UNIT 50LC	NOM. V-Ph-Hz	IFM TYPE	ELECTRIC HEATER PART NUMBER CRHEATER***A00 VERT/HORZ	NOM PWR (kW)	APP PWR (kW)	SINGLE POINT KIT PART NUMBER CRSINGLEXXXXA00			
						NO C.O. or UNPWRD C.O.		w/PWRD C.O.	
						NO P.E.	w/ P.E. (pwrd fr/unit)	NO P.E.	w/ P.E. (pwrd fr/unit)
17	208/ 230-3-60	STD	279/270A00	25.0	18.8/23.0	-	-	-	-
			280/271A00	50.0	37.6/45.9	056	056	056	056
			281/272A00	75.0	56.3/68.9	056	056	056	056
		MED	279/270A00	25.0	18.8/23.0	-	-	-	-
			280/271A00	50.0	37.6/45.9	056	056	056	056
			281/272A00	75.0	56.3/68.9	056	056	056	056
		HIGH	279/270A00	25.0	18.8/23.0	-	-	-	056
			280/271A00	50.0	37.6/45.9	056	056	056	056
			281/272A00	75.0	56.3/68.9	056	056	056	056
		ULTRA HIGH	279/270A00	25.0	18.8/23.0	-	056	056	056
			280/271A00	50.0	37.6/45.9	056	056	056	056
			281/272A00	75.0	56.3/68.9	056	056	056	056
	460-3-60	STD	282/273A00	25.0	23.0	-	-	-	-
			283/274A00	50.0	45.9	-	057	057	057
			284/275A00	75.0	68.9	057	057	057	057
		MED	282/273A00	25.0	23.0	-	-	-	-
			283/274A00	50.0	45.9	057	057	057	057
			284/275A00	75.0	68.9	057	057	057	057
		HIGH	282/273A00	25.0	23.0	-	-	-	-
			283/274A00	50.0	45.9	057	057	057	057
			284/275A00	75.0	68.9	057	057	057	057
		ULTRA HIGH	282/273A00	25.0	23.0	-	-	-	-
			283/274A00	50.0	45.9	057	057	057	057
			284/275A00	75.0	68.9	057	057	057	057
575-3-60	STD	285/276A00	24.8	22.8	-	-	-	-	
		286/277A00	49.6	45.6	-	057	-	057	
		287/278A00	74.4	68.3	057	057	057	057	
	MED	285/276A00	24.8	22.8	-	-	-	-	
		286/277A00	49.6	45.6	-	057	057	057	
		287/278A00	74.4	68.3	057	057	057	057	
	HIGH	285/276A00	24.8	22.8	-	-	-	-	
		286/277A00	49.6	45.6	057	057	057	057	
		287/278A00	74.4	68.3	057	057	057	057	
	ULTRA HIGH	285/276A00	24.8	22.8	-	-	-	-	
		286/277A00	49.6	45.6	057	057	057	057	
		287/278A00	74.4	68.3	057	057	057	057	

LEGEND

- APP PWR - 208 / 230V / 460V / 575V
- C.O. - Convenience outlet
- IFM - Indoor fan motor
- NOM PWR - 240V / 480V / 600V
- P.E. - Power exhaust
- Pwr fr/unit - Powered from unit
- PWRD - Powered convenience outlet
- UNPWRD - Unpowered convenience outlet

UNIT 50LC	NOM. V-Ph-Hz	IFM TYPE	ELECTRIC HEATER PART NUMBER CRHEATER***A00 VERT/HORZ	NOM PWR (kW)	APP PWR (kW)	SINGLE POINT KIT PART NUMBER CRSINGLEXXXXA00			
						NO C.O. or UNPWRD C.O.		w/PWRD C.O.	
						NO P.E.	w/ P.E. (pwrd fr/unit)	NO P.E.	w/ P.E. (pwrd fr/unit)
20	208/ 230-3-60	STD	279/270A00	25.0	18.8/23.0	-	-	-	-
			280/271A00	50.0	37.6/45.9	056	056	056	056
			281/272A00	75.0	56.3/68.9	056	056	056	056
		MED	279/270A00	25.0	18.8/23.0	-	-	-	-
			280/271A00	50.0	37.6/45.9	056	056	056	056
			281/272A00	75.0	56.3/68.9	056	056	056	056
		HIGH	279/270A00	25.0	18.8/23.0	-	-	-	056
			280/271A00	50.0	37.6/45.9	056	056	056	056
			281/272A00	75.0	56.3/68.9	056	056	056	056
		ULTRA HIGH	279/270A00	25.0	18.8/23.0	-	056	056	056
			280/271A00	50.0	37.6/45.9	056	056	056	056
			281/272A00	75.0	56.3/68.9	056	056	056	056
	460-3-60	STD	282/273A00	25.0	23.0	-	-	-	-
			283/274A00	50.0	45.9	-	057	057	057
			284/275A00	75.0	68.9	057	057	057	057
		MED	282/273A00	25.0	23.0	-	-	-	-
			283/274A00	50.0	45.9	057	057	057	057
			284/275A00	75.0	68.9	057	057	057	057
		HIGH	282/273A00	25.0	23.0	-	-	-	-
			283/274A00	50.0	45.9	057	057	057	057
			284/275A00	75.0	68.9	057	057	057	057
		ULTRA HIGH	282/273A00	25.0	23.0	-	-	-	-
			283/274A00	50.0	45.9	057	057	057	057
			284/275A00	75.0	68.9	057	057	057	057
575-3-60	STD	285/276A00	24.8	22.8	-	-	-	-	
		286/277A00	49.6	45.6	-	057	-	057	
		287/278A00	74.4	68.3	057	057	057	057	
	MED	285/276A00	24.8	22.8	-	-	-	-	
		286/277A00	49.6	45.6	-	057	057	057	
		287/278A00	74.4	68.3	057	057	057	057	
	HIGH	285/276A00	24.8	22.8	-	-	-	-	
		286A/27700	49.6	45.6	057	057	057	057	
		287/278A00	74.4	68.3	057	057	057	057	
	ULTRA HIGH	285/276A00	24.8	22.8	-	-	-	-	
		286/277A00	49.6	45.6	057	057	057	057	
		287/278A00	74.4	68.3	057	057	057	057	

LEGEND

- APP PWR - 208 / 230V / 460V / 575V
- C.O. - Convenience outlet
- IFM - Indoor fan motor
- NOM PWR - 240V / 480V / 600V
- P.E. - Power exhaust
- Pwr fr/unit - Powered from unit
- PWRD - Powered convenience outlet
- UNPWRD - Unpowered convenience outlet

UNIT 50LC	NOM. V-Ph-Hz	IFM TYPE	ELECTRIC HEATER PART NUMBER CRHEATER***A00 VERT/HORZ	NOM PWR (kW)	APP PWR (kW)	SINGLE POINT KIT PART NUMBER CRSINGLEXXXXA00			
						NO C.O. or UNPWRD C.O.		w/PWRD C.O.	
						NO P.E.	w/ P.E. (pwrd fr/unit)	NO P.E.	w/ P.E. (pwrd fr/unit)
24	208/ 230-3-60	STD	279/270A00	25.0	18.8/23.0	-	-	-	056
			280/271A00	50.0	37.6/45.9	056	056	056	056
			281/272A00	75.0	56.3/68.9	056	056	056	056
		MED	279A/27000	25.0	18.8/23.0	-	-	-	056
			280/271A00	50.0	37.6/45.9	056	056	056	056
			281/272A00	75.0	56.3/68.9	056	056	056	056
		HIGH	279/270A00	25.0	18.8/23.0	-	056	-	056
			280/271A00	50.0	37.6/45.9	056	056	056	056
			281/272A00	75.0	56.3/68.9	056	056	056	056
		ULTRA HIGH	279/270A00	25.0	18.8/23.0	056	056	056	056
			280/271A00	50.0	37.6/45.9	056	056	056	056
			281/272A00	75.0	56.3/68.9	056	056	056	056
	460-3-60	STD	282/273A00	25.0	23.0	-	057	-	057
			283/274A00	50.0	45.9	057	057	057	057
			284/275A00	75.0	68.9	057	057	057	057
		MED	282/273A00	25.0	23.0	-	057	-	057
			283/274A00	50.0	45.9	057	057	057	057
			284/275A00	75.0	68.9	057	057	057	057
		HIGH	282/273A00	25.0	23.0	-	057	057	057
			283/274A00	50.0	45.9	057	057	057	057
			284/275A00	75.0	68.9	057	057	057	057
		ULTRA HIGH	282/273A00	25.0	23.0	057	057	057	057
			283/274A00	50.0	45.9	057	057	057	057
			284/275A00	75.0	68.9	057	057	057	057
575-3-60	STD	285/276A00	24.8	22.8	-	-	-	-	
		286/277A00	49.6	45.6	-	057	057	057	
		287/278A00	74.4	68.3	057	057	057	057	
	MED	285/276A00	24.8	22.8	-	-	-	-	
		286/277A00	49.6	45.6	-	057	057	057	
		287/278A00	74.4	68.3	057	057	057	057	
	HIGH	285/276A00	24.8	22.8	-	-	-	-	
		286/277A00	49.6	45.6	057	057	057	057	
		287/278A00	74.4	68.3	057	057	057	057	
	ULTRA HIGH	285/276A00	24.8	22.8	-	-	-	-	
		286/277A00	49.6	45.6	057	057	057	057	
		287/278A00	74.4	68.3	057	057	057	057	

LEGEND

- APP PWR - 208 / 230V / 460V / 575V
- C.O. - Convenience outlet
- IFM - Indoor fan motor
- NOM PWR - 240V / 480V / 600V
- P.E. - Power exhaust
- Pwr fr/unit - Powered from unit
- PWRD - Powered convenience outlet
- UNPWRD - Unpowered convenience outlet

UNIT 50LC	NOM. V-Ph-Hz	IFM TYPE	ELECTRIC HEATER PART NUMBER CRHEATER***A00 VERT/HORZ	NOM PWR (kW)	APP PWR (kW)	SINGLE POINT KIT PART NUMBER CRSINGLEXXXXA00			
						NO C.O. or UNPWRD C.O.		w/PWRD C.O.	
						NO P.E.	w/ P.E. (pwrd fr/unit)	NO P.E.	w/ P.E. (pwrd fr/unit)
26	208/ 230-3-60	STD	279/270A00	25.0	18.8/23.0	056	056	056	056
			280/271A00	50.0	37.6/45.9	056	056	056	056
			281/272A00	75.0	56.3/68.9	056	056	056	056
		MED	279/270A00	25.0	18.8/23.0	056	056	056	056
			280/271A00	50.0	37.6/45.9	056	056	056	056
			281/272A00	75.0	56.3/68.9	056	056	056	056
		HIGH	279/270A00	25.0	18.8/23.0	056	056	056	056
			280/271A00	50.0	37.6/45.9	056	056	056	056
			281/272A00	75.0	56.3/68.9	056	056	056	056
	460-3-60	STD	282/273A00	25.0	23.0	057	057	057	057
			283/274A00	50.0	45.9	057	057	057	057
			284/275A00	75.0	68.9	057	057	057	057
		MED	282/273A00	25.0	23.0	057	057	057	057
			283/274A00	50.0	45.9	057	057	057	057
			284/275A00	75.0	68.9	057	057	057	057
		HIGH	282/273A00	25.0	23.0	057	057	057	057
			283/274A00	50.0	45.9	057	057	057	057
			284/275A00	75.0	68.9	057	057	057	057
	575-3-60	STD	285/276A00	24.8	22.8	-	-	-	057
			286/277A00	49.6	45.6	-	057	057	057
			287/278A00	74.4	68.3	057	057	057	057
		MED	285/276A00	24.8	22.8	-	057	-	057
			286/277A00	49.6	45.6	057	057	057	057
			287/278A00	74.4	68.3	057	057	057	057
HIGH		285/276A00	24.8	22.8	-	057	057	057	
		286/277A00	49.6	45.6	057	057	057	057	
		287/278A00	74.4	68.3	057	057	057	057	

LEGEND

- APP PWR - 208 / 230V / 460V / 575V
- C.O. - Convenience outlet
- IFM - Indoor fan motor
- NOM PWR - 240V / 480V / 600V
- P.E. - Power exhaust
- Pwrd fr/unit - Powered from unit
- PWRD - Powered convenience outlet
- UNPWRD - Unpowered convenience outlet

UNIT: DIMENSIONS, WEIGHTS & CURBS

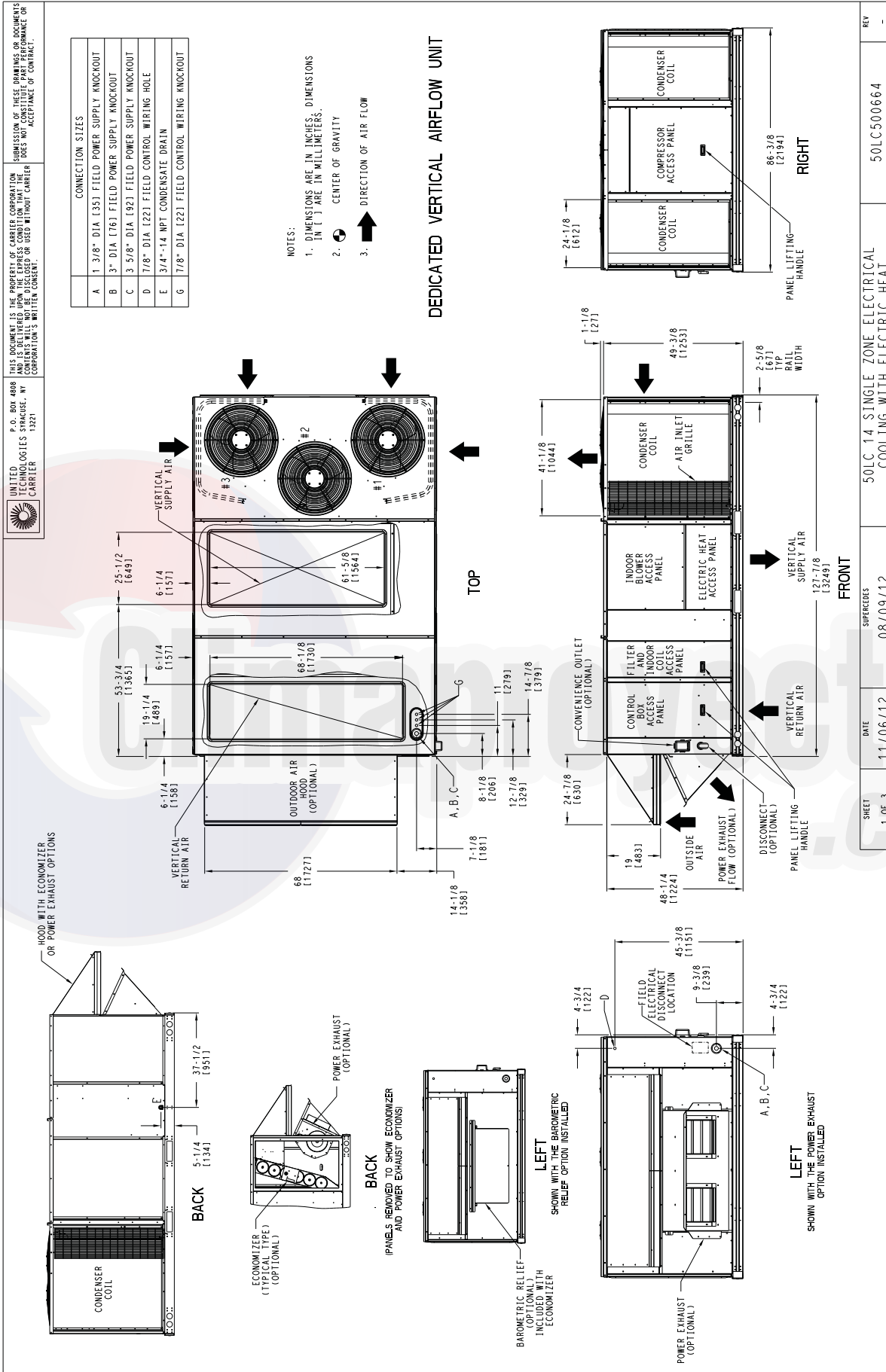

SHEET	1 OF 3	DATE	11/06/12	SUPERCEDES	08/09/12	50LC14 SINGLE ZONE ELECTRICAL COOLING WITH ELECTRIC HEAT	50LC500664	REV	-
-------	--------	------	----------	------------	----------	--	------------	-----	---

Fig. 1 - Dimensions 50LC 14

UNIT: DIMENSIONS, WEIGHTS & CURBS (cont.)

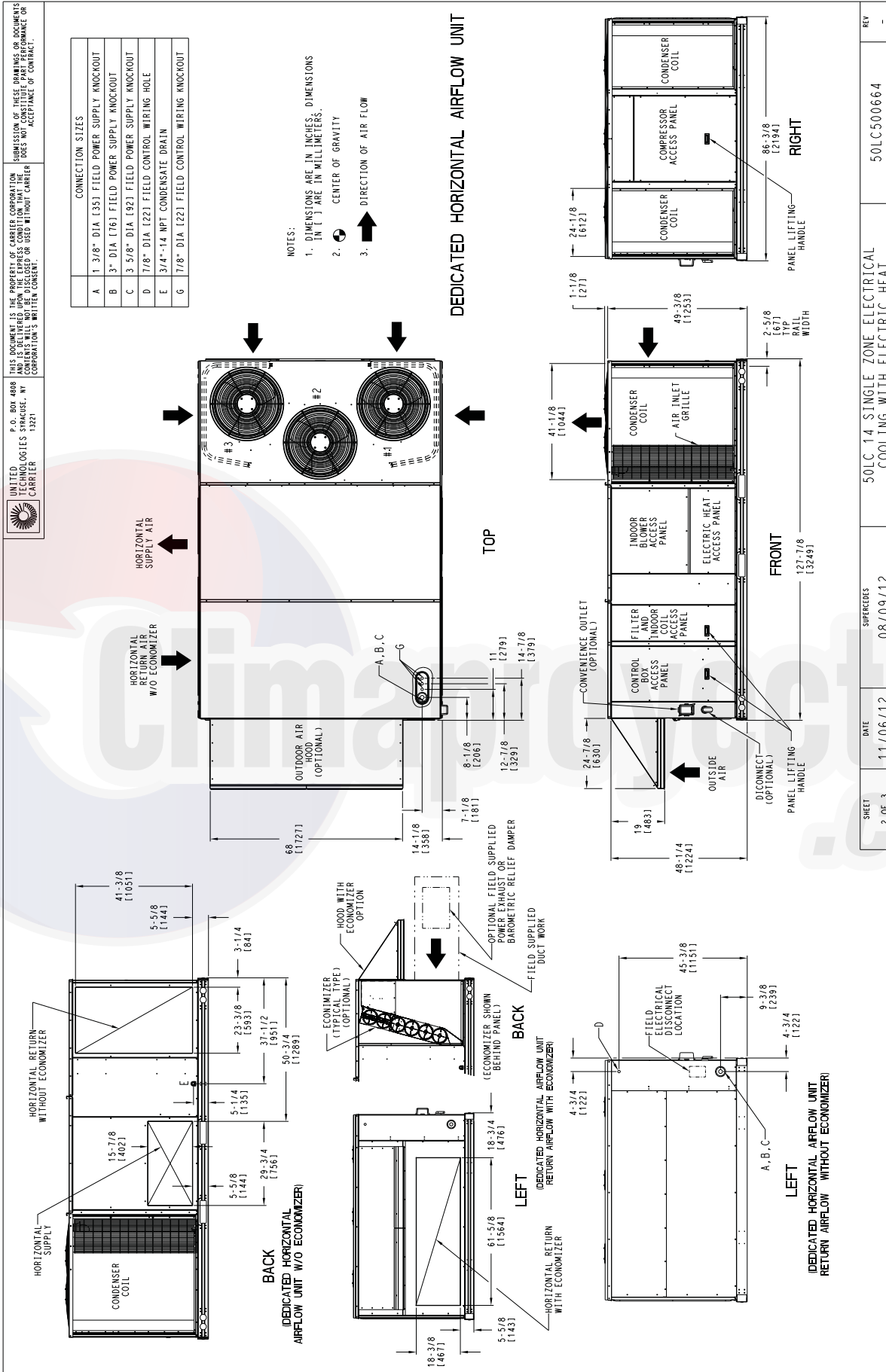

SHEET 2 OF 3

DATE 11/06/12

SUPERCEDES 08/09/12

50LC 14 SINGLE ZONE ELECTRICAL COOLING WITH ELECTRIC HEAT

50LC500664

REV -

Fig. 2 - Dimensions 50LC 14

UNIT: DIMENSIONS, WEIGHTS & CURBS (cont.)

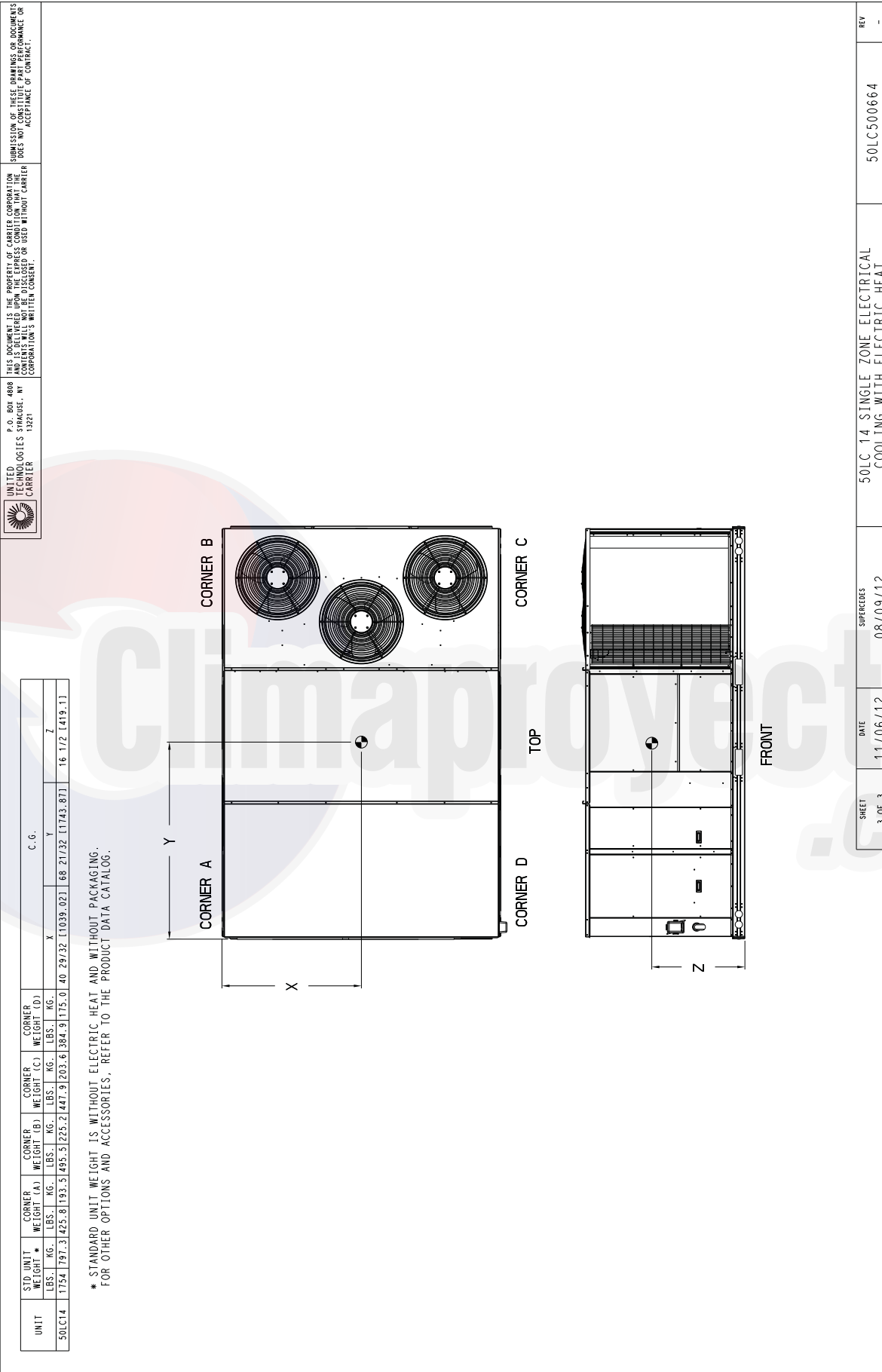
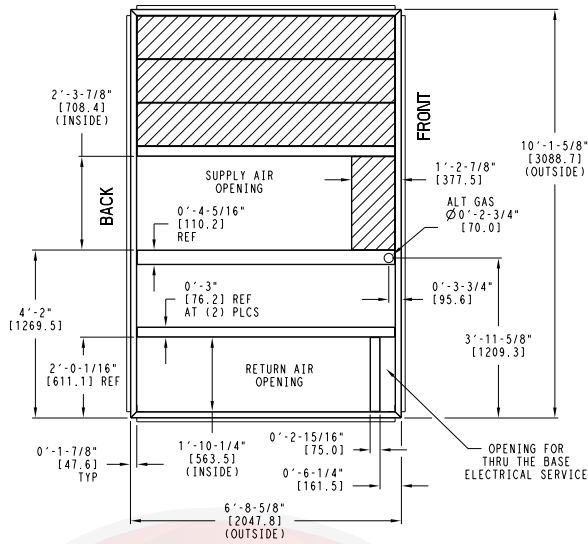

Fig. 3 - Dimensions 50LC 14

UNIT: DIMENSIONS, WEIGHTS & CURBS (cont.)

UNIT SIZE	"A"	ROOF CURB ACCESSORY
14	1'-2" [356.0] 2'-0" [610.0]	CRRFCURB045A00 CRRFCURB046A00



NOTES:

- 1 ROOF CURB ACCESSORY IS SHIPPED UNASSEMBLED.
- 2 DIMENSIONS IN [] ARE IN MILLIMETERS.
- 3 ROOF CURB GALVANIZED STEEL.
- 4 ATTACH DUCTWORK TO CURB (FLANGES ON DUCT REST ON CURB)
- 5 SERVICE CLEARANCE 4 FT ON EACH SIDE

➔ DIRECTION OF AIR FLOW

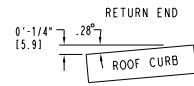
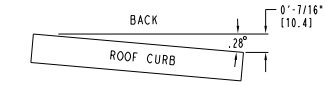

MAX CURB LEVELING TOLERANCES

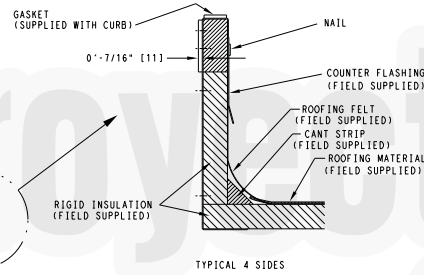
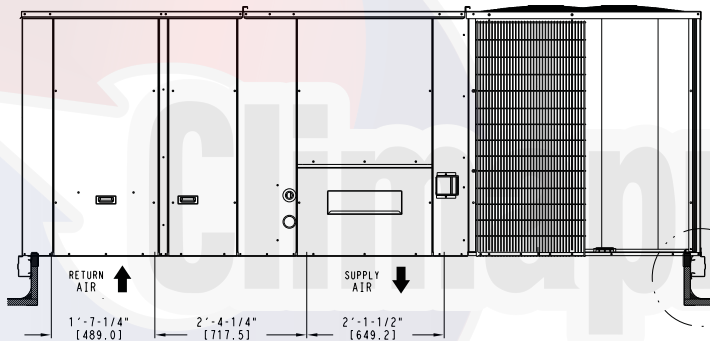

TYPICAL 4 SIDES

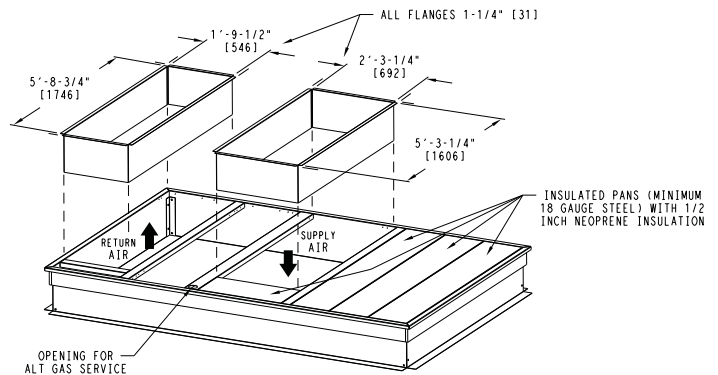
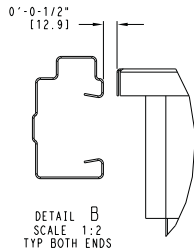
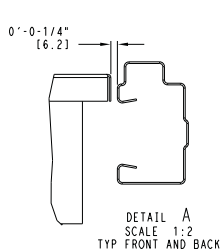
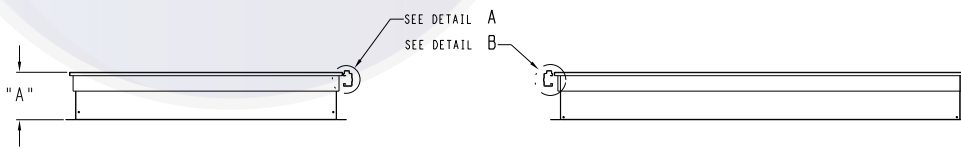

Fig. 4 - Roof Curb Details 50LC 14

C13054

UNIT: DIMENSIONS, WEIGHTS & CURBS (cont.)

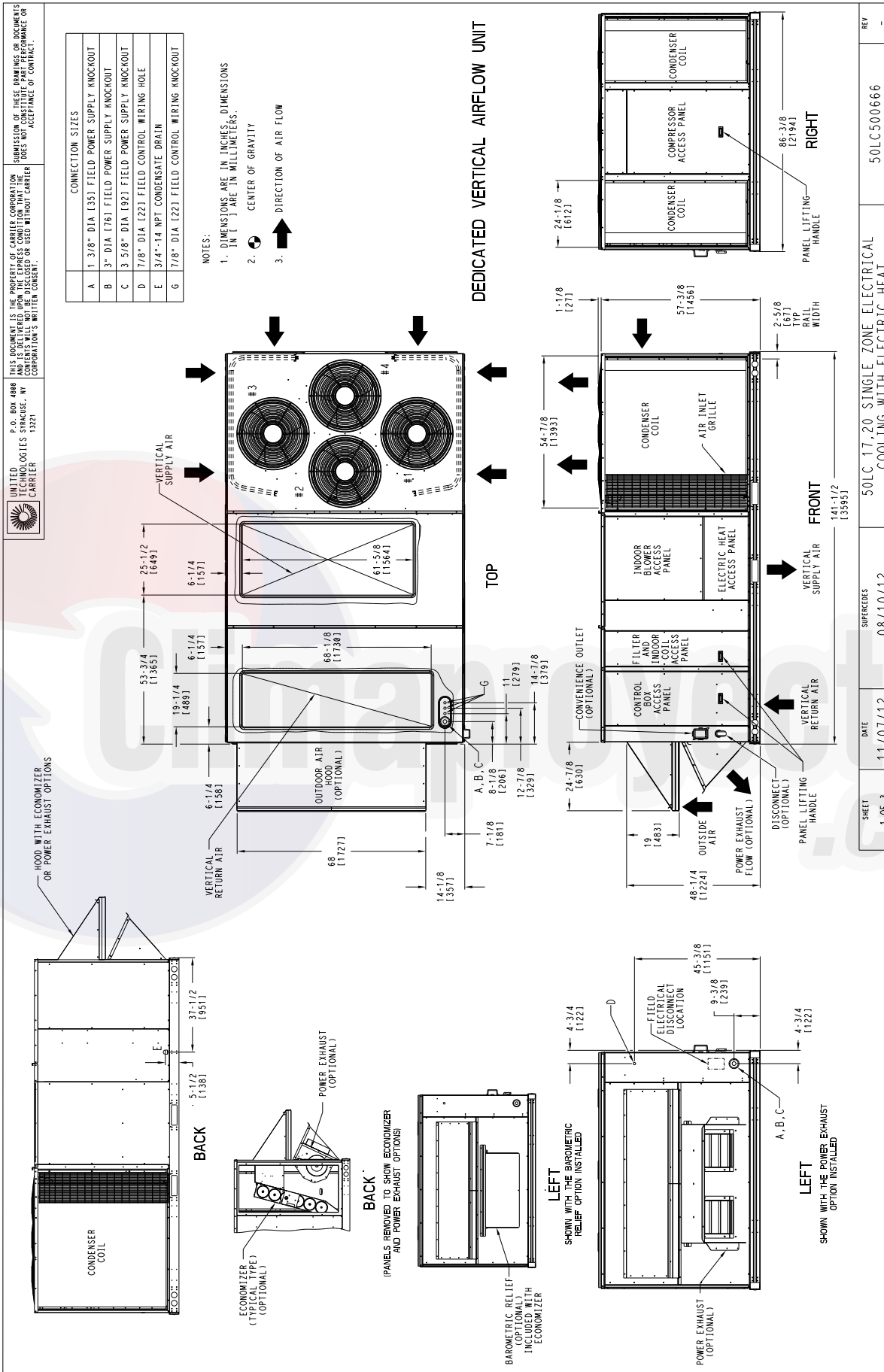

Fig. 5 - Dimensions 50LC 17 - 20

UNIT: DIMENSIONS, WEIGHTS & CURBS (cont.)

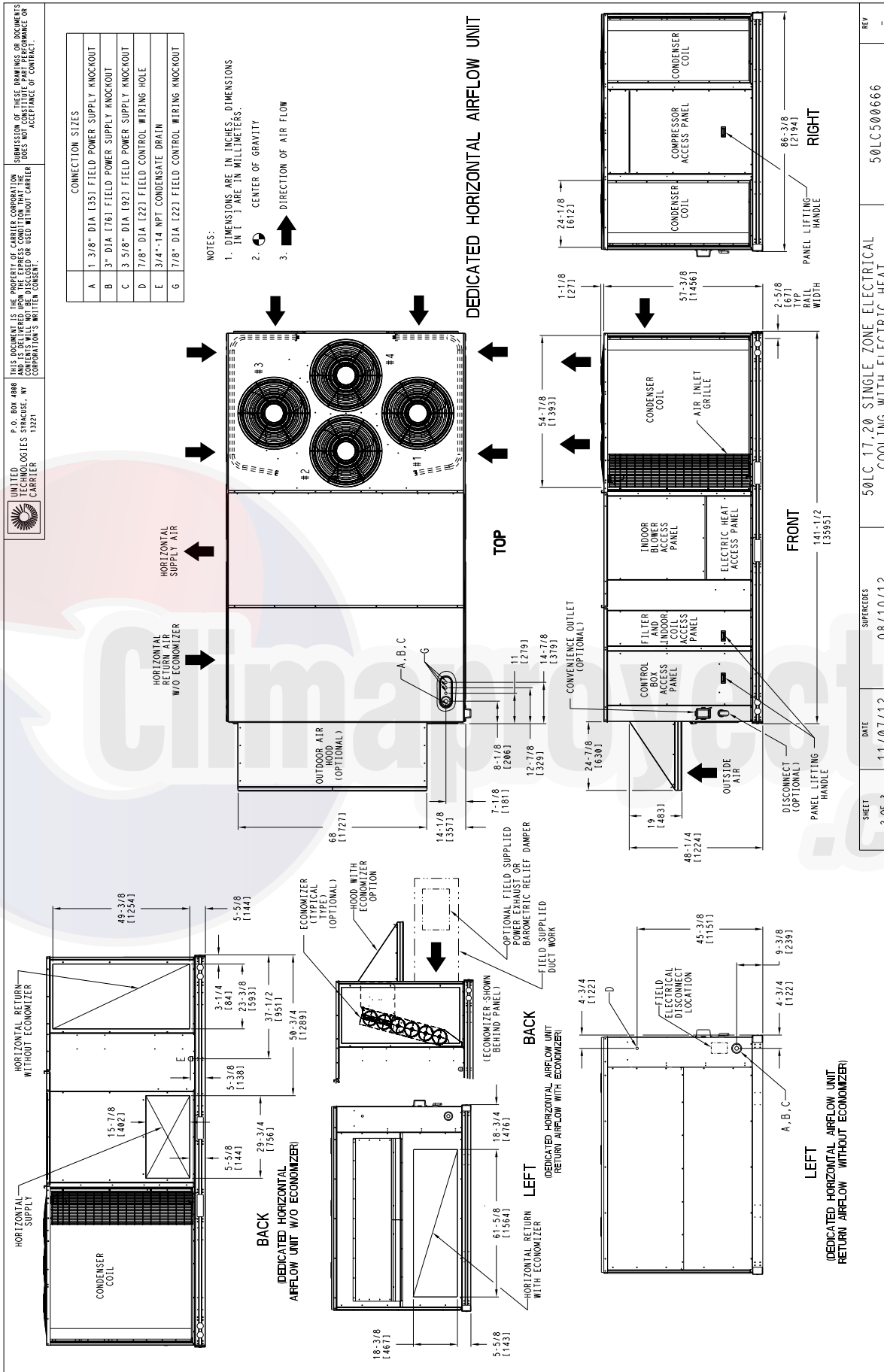

Fig. 6 - Dimensions 50LC 17 - 20

UNIT: DIMENSIONS, WEIGHTS & CURBS (cont.)

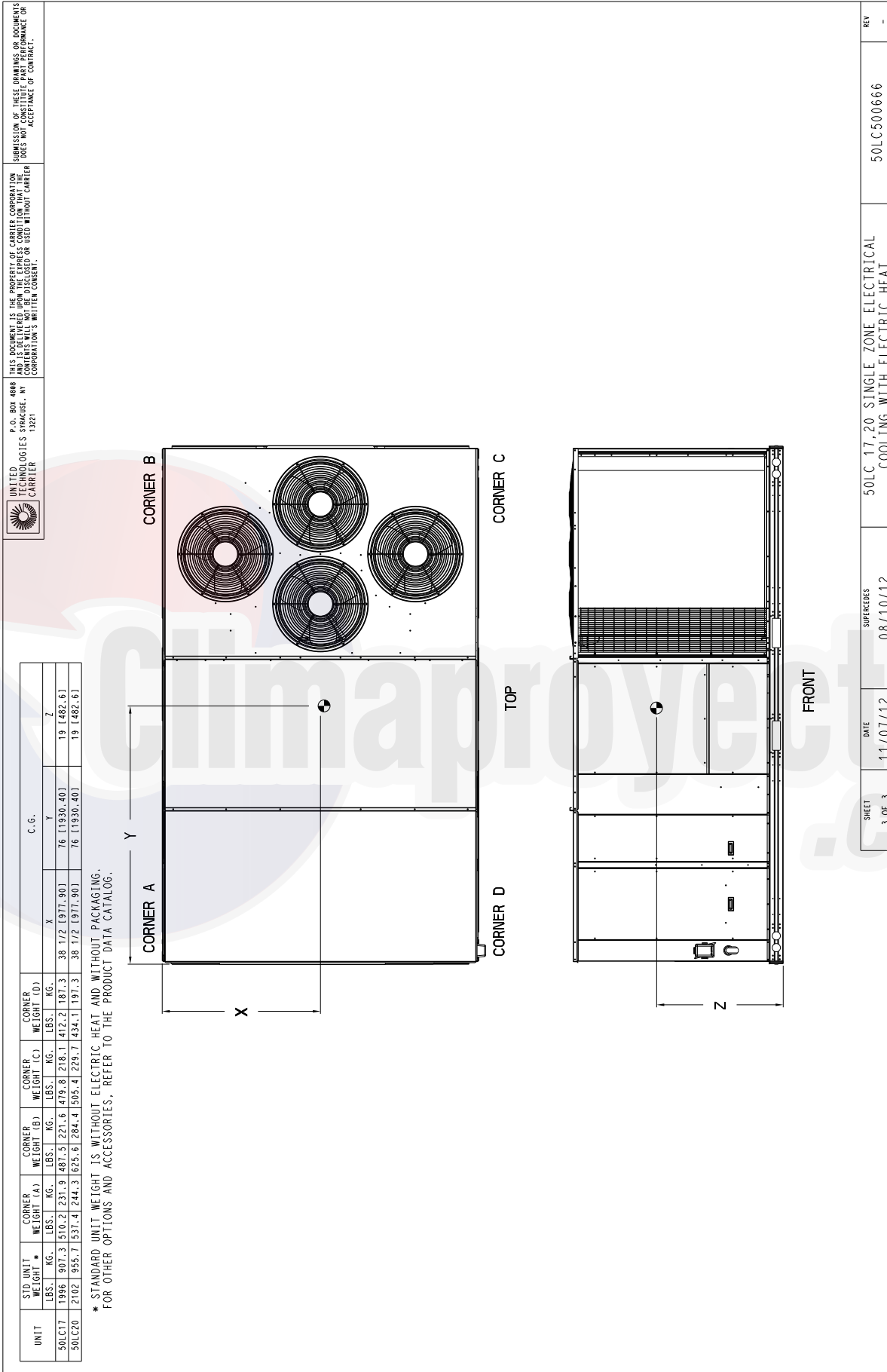
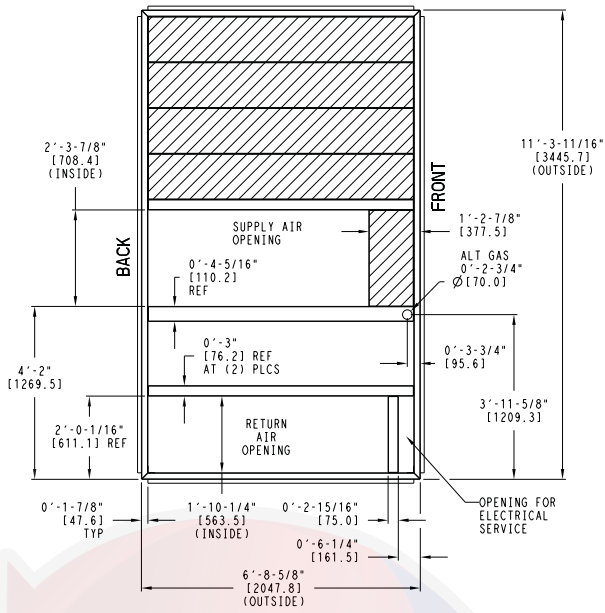

Fig. 7 - Dimensions 50LC 17 - 20

UNIT: DIMENSIONS, WEIGHTS & CURBS (cont.)

UNIT SIZE	"A"	ROOF CURB ACCESSORY
17, 20	1'-2" [356.0] 2'-0" [610.0]	CRRFCURB047A00 CRRFCURB048A00



NOTES:

- 1 ROOF CURB ACCESSORY IS SHIPPED UNASSEMBLED.
- 2 DIMENSIONS IN [] ARE IN MILLIMETERS.
- 3 ROOF CURB GALVANIZED STEEL.
- 4 ATTACH DUCTWORK TO CURB (FLANGES ON DUCT REST ON CURB)
- 5 SERVICE CLEARANCE 4 FT ON EACH SIDE

➔ DIRECTION OF AIR FLOW

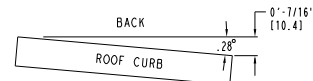

MAX CURB LEVELING TOLERANCES

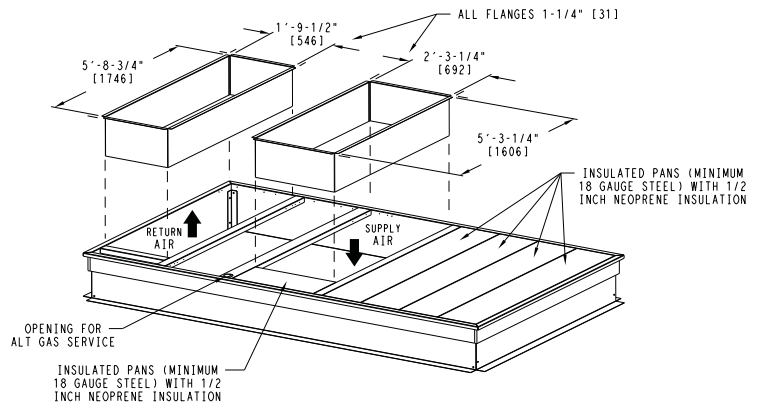
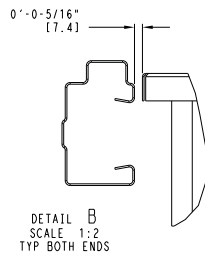
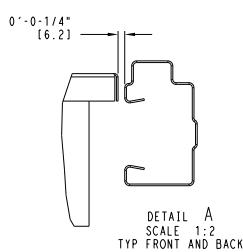
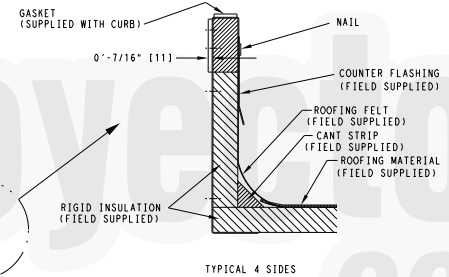
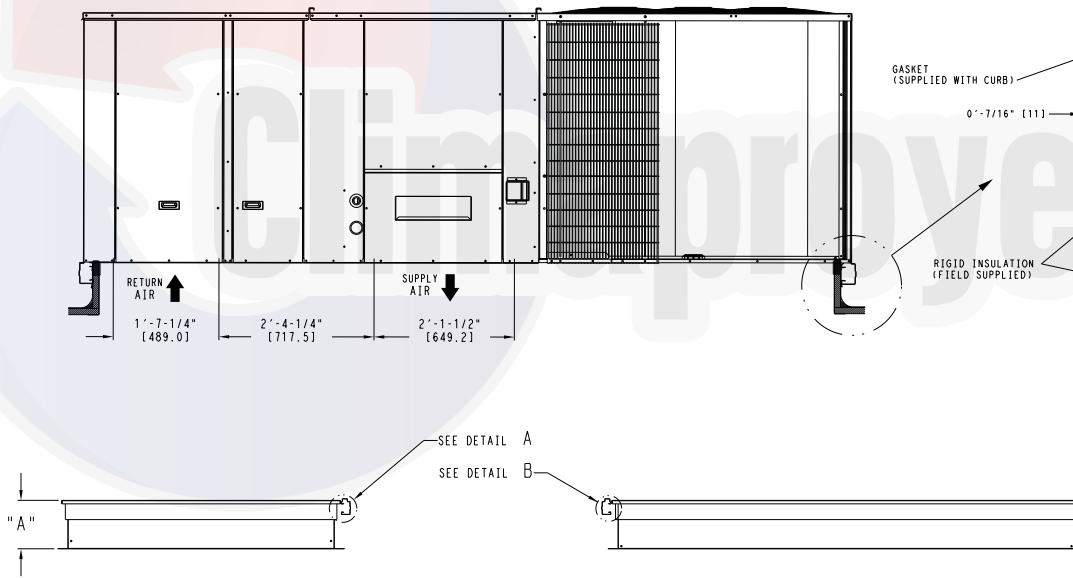
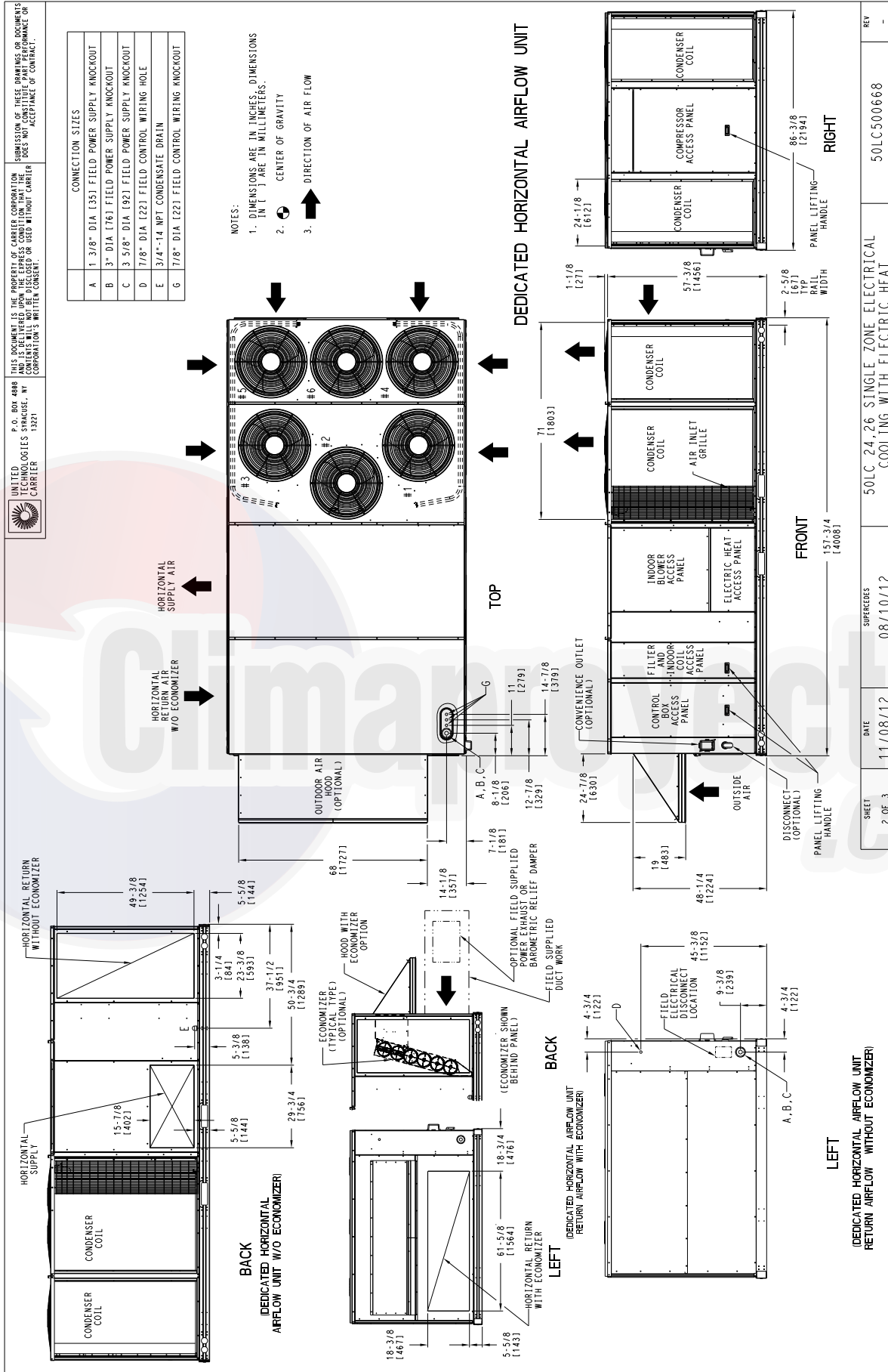

Fig. 8 - Roof Curb Details 50LC 17-20

C13055

UNIT: DIMENSIONS, WEIGHTS & CURBS (cont.)



SHEET	DATE	SUPERCEDES	REV
2 OF 3	11/08/12	08/10/12	-
50LC 24, 26 SINGLE ZONE ELECTRICAL COOLING WITH ELECTRIC HEAT			50LC500668

Fig. 10 - Dimensions 50LC 24, 26

UNIT: DIMENSIONS, WEIGHTS & CURBS (cont.)

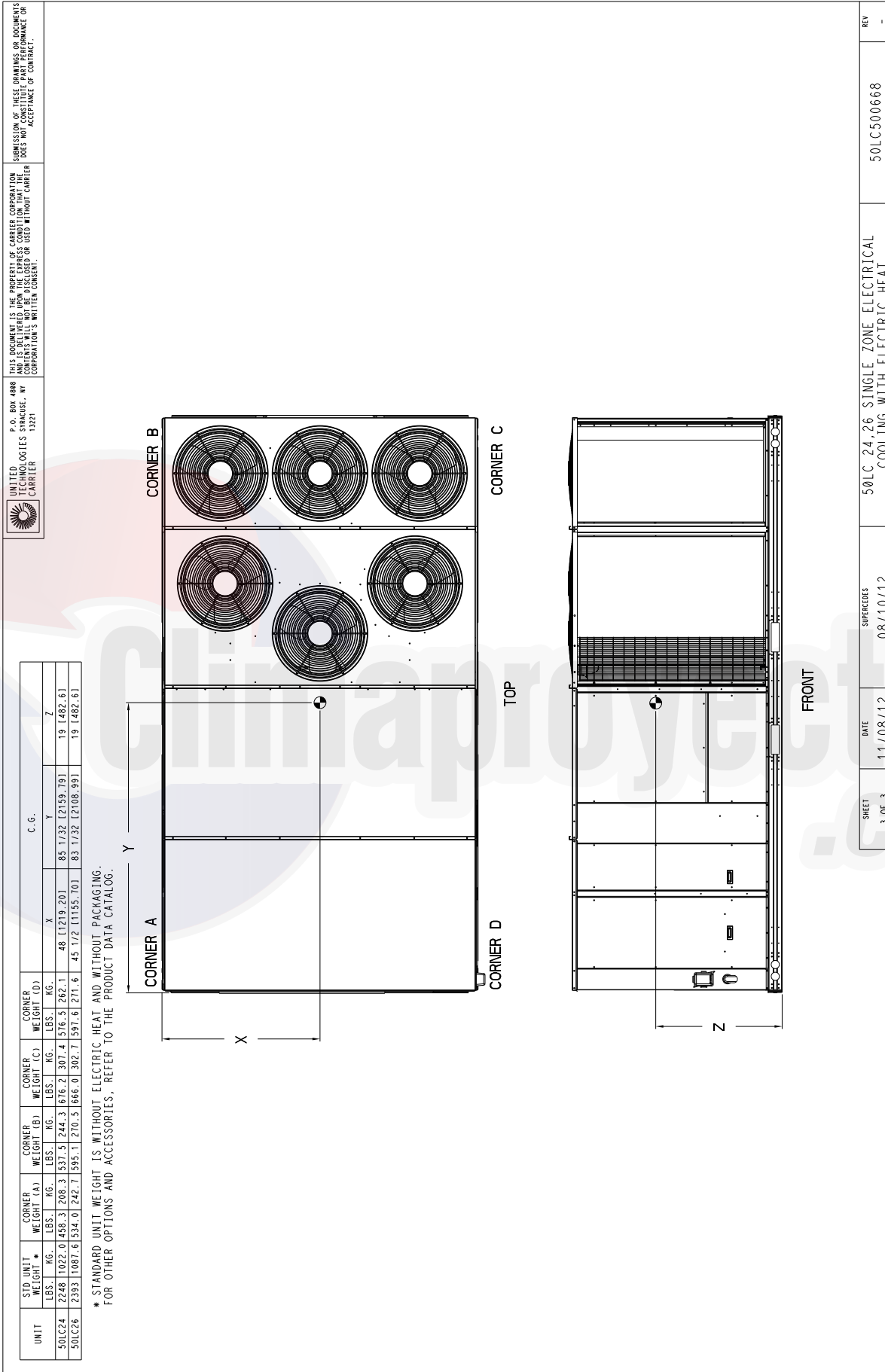
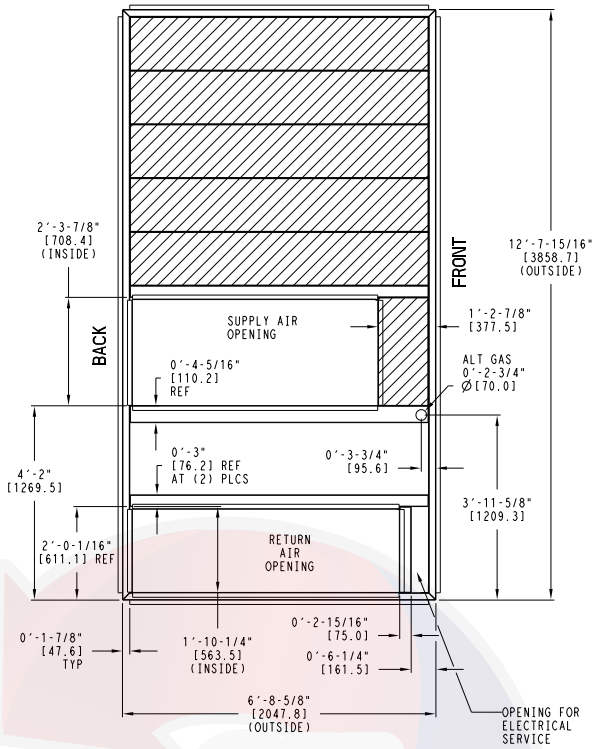

Fig. 11 - Dimensions 50LC 24, 26

UNIT: DIMENSIONS, WEIGHTS & CURBS (cont.)

UNIT SIZE	"A"	ROOF CURB ACCESSORY
24, 26	1'-2" [356.0] 2'-0" [610.0]	CRRFCURB049A00 CRRFCURB050A00



- NOTES:
- 1 ROOF CURB ACCESSORY IS SHIPPED UNASSEMBLED.
 - 2 BOLT HEADS TO BE ON INSIDE OF FLANGE. CLEARANCE IS (11) 0-0-7/16" TYP ALL CORNERS.
 - 3 DIMENSIONS IN () ARE IN MILLIMETERS.
 - 4 ROOF CURB GALVANIZED STEEL.
 - 5 ATTACH DUCTWORK TO CURB (FLANGES ON DUCT REST ON CURB)
 - 6 SERVICE CLEARANCE 4 FT ON EACH SIDE
 - 7 GAS SERVICE PLATE IS PART OF A SEPARATELY SHIPPED ACCESSORY PACKAGE.
 - 8 GAS SERVICE PLATE CAN BE USED WITH EITHER ACCESSORY ROOFCURB.

➔ DIRECTION OF AIR FLOW

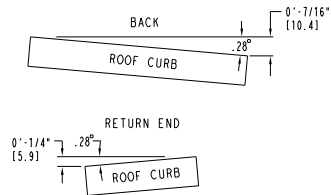

MAX CURB LEVELING TOLERANCES

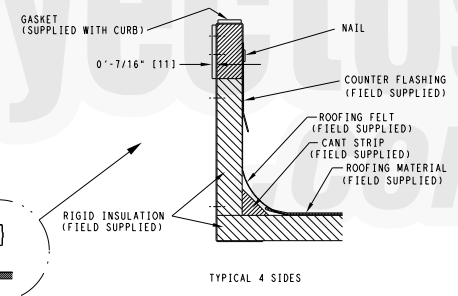
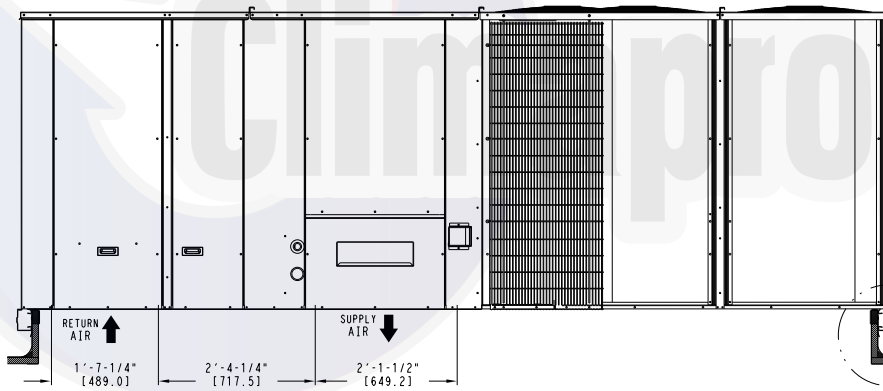

TYPICAL 4 SIDES

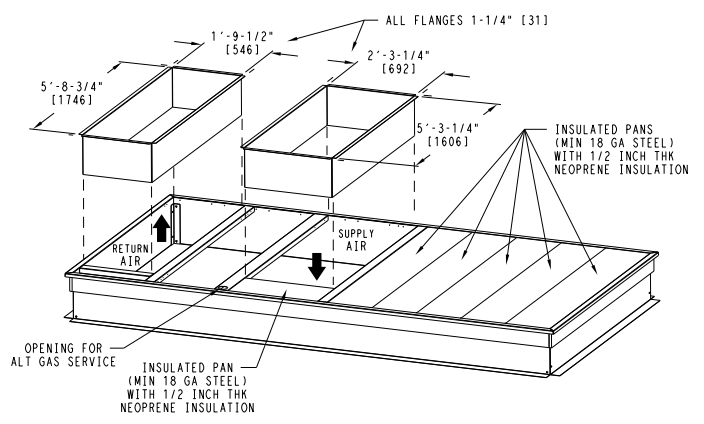
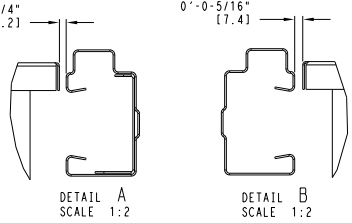
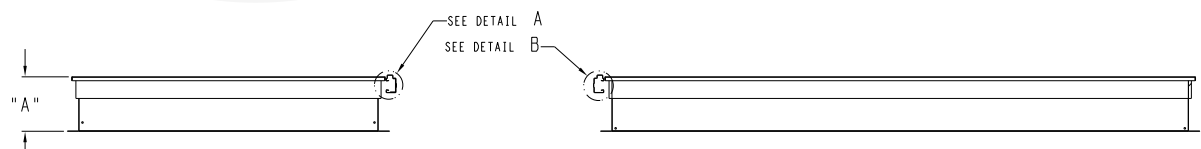
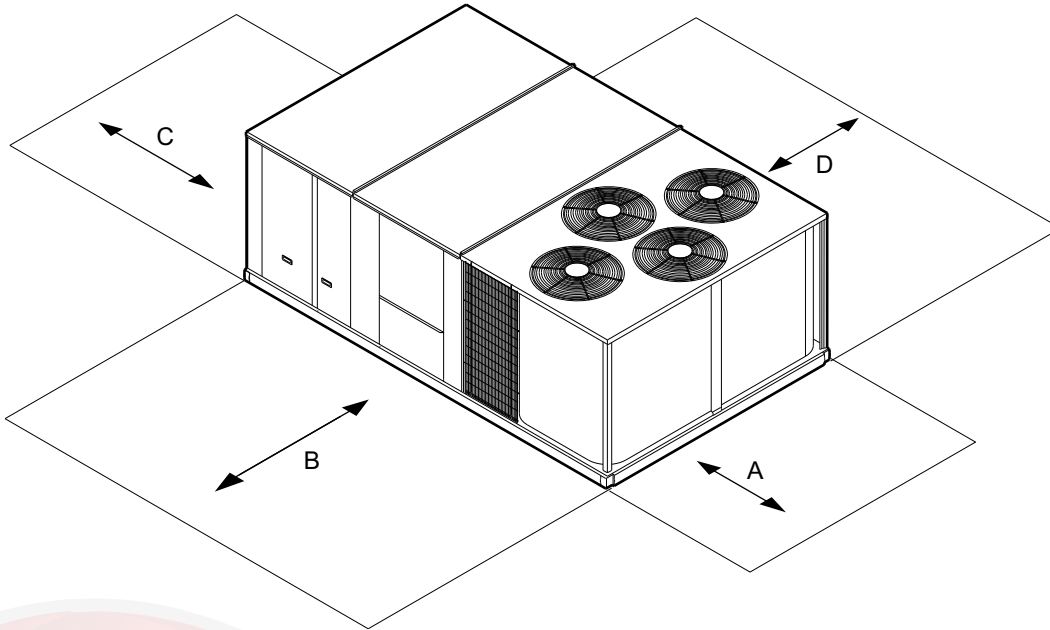

Fig. 12 - Roof Curb Details 50LC 24, 26

C13056

UNIT: DIMENSIONS, WEIGHTS & CURBS (cont.)



C13292

LOCATION	DIMENSION	CONDITION
A	36-in (914 mm)	<ul style="list-style-type: none"> Recommended clearance for air flow and service
B	42-in (1067 mm)	<ul style="list-style-type: none"> Recommended clearance for air flow and service
C	18-in (457 mm)	<ul style="list-style-type: none"> No Convenience Outlet No Economizer No field installed disconnect on economizer hood side (Factory-installed disconnect installed).
	36-in (914 mm)	<ul style="list-style-type: none"> Convenience Outlet installed. Vertical surface behind servicer is electrically non-conductive (e.g.: wood, fiberglass).
	42-in (1067 mm)	<ul style="list-style-type: none"> Convenience Outlet installed. Vertical surface behind servicer is electrically conductive (e.g.: metal, masonry).
C	96-in (2438 mm)	<ul style="list-style-type: none"> Economizer and/or Power Exhaust installed. Check for sources of flue products with 10 feet (3 meters) of economizer fresh air intake.
	42-in (1067 mm)	<ul style="list-style-type: none"> Recommended clearance for service.

NOTE: 1. Unit not designed to have overhead obstruction. Contact Application Engineering for guidance on any application planning overhead obstruction or for vertical clearances.

2. The number of fans varies with the unit size. Depending on size unit will have three to six fans.

Fig. 13 - Service Clearance Dimensional Drawing — Typical All 50LC 14-26 Units

OPTIONS & ACCESSORY WEIGHTS

OPTION / ACCESSORY	WEIGHTS in LBS				
	50LC**14	50LC**17	50LC**20	50LC**24	50LC**26
Humidi–MiZer® System	120	120	120	120	120
Low Electric Heat	85	85	85	85	85
Medium Electric Heat	100	100	100	100	100
High Electric Heat	100	100	100	100	100
Return Smoke Detector	5	5	5	5	5
Supply Smoke Detector	5	5	5	5	5
RA & SA Smoke Detector	10	10	10	10	10
CO ₂ sensor	5	5	5	5	5
RA Smoke Detector & CO ₂	10	10	10	10	10
SA Smoke Detector & CO ₂	10	10	10	10	10
RA & SA Smoke Detector & CO ₂	15	15	15	15	15
Medium Static Option	5	6	6	10	10
High Static Option	11	16	16	20	20
Cu/Cu Cond & Al/Cu Evap	28	34	34	34	34
Cu/Cu Cond & Cu/Cu Evap	53	64	64	64	64
Al/Cu Cond & Al/Cu Evap + Hail Guard	60	150	150	150	150
Pre–coat Al/Cu Cond & Al/Cu Evap + Hail Guard	60	150	150	150	150
E–coat Al/Cu Cond & Al/Cu Evap + Hail Guard	60	150	150	150	150
E–coat Al/Cu Cond & E–coat Al/Cu Evap + Hail Guard	60	150	150	150	150
Cu/Cu Cond & Al/Cu Evap + Hail Guard	88	184	184	184	184
Cu/Cu Cond & Cu/Cu Evap + Hail Guard	113	214	214	214	214
Temp Ultra Low Leak Econo w/Baro Relief	246	246	246	246	246
Temp Ultra Low Leak Econo w/Power Exhaust	371	371	371	371	371
Enthalpy Ultra Low Leak Econo w/Baro Relief	246	246	246	246	246
Enthalpy Ultra Low Leak Econo w/Power Exhaust	371	371	371	371	371
Unpowered Convenience Outlet	5	5	5	5	5
Powered Convenience outlet	35	35	35	35	35
Hinged Panels	5	5	5	5	5
Hinged Panels with Unpowered Convenience Outlet	10	10	10	10	10
Hinged Panels with Powered Convenience Outlet	40	40	40	40	40
HACR Breaker	10	10	10	10	10
Non–Fused Disconnect	15	15	15	15	15

APPLICATION DATA

Min operating ambient temp (cooling):

In mechanical cooling mode, your Carrier rooftop can safely operate down to an outdoor ambient temperature of 40°F (4°C).

An economizer shall be the source of cooling in low ambient conditions. When the outside air temperature is below 40°F, to improve system reliability, reduce energy usage, and improve system efficiency: mechanical cooling shall not be utilized. Therefore, an economizer shall be used in these conditions to provide efficient low ambient cooling. Using an economizer for low ambient cooling merely requires fan energy to satisfy space requirements. The compressors shall not be required to run which will provide exceptional energy savings due to less power draw, improved system reliability due to fewer compressor run hours, improved reliability through fewer starts/stops, and lower life cycle costs due to reduced compressor maintenance.

Max operating ambient temp (cooling):

The maximum operating ambient temperature for cooling mode is 125°F (52°C). While cooling operation above 125°F (52°C) may be possible, it could cause either a reduction in performance, reliability, or a protective action by the unit's internal safety devices. For proper minimum and maximum CFM values see Table 6.

Min and max airflow (cooling mode):

To maintain safe and reliable operation of your rooftop, operate within the cooling airflow limits. Operating above the max may cause blow-off, undesired airflow noise, or airflow related problems with the rooftop unit. Operating below the min may cause problems with coil freeze-up.

Airflow:

All units are draw-through in cooling mode.

Outdoor air application strategies:

Economizers reduce operating expenses and compressor run time by providing a free source of cooling and a means of ventilation to match application changing needs. In fact, they should be considered for most applications. Also, consider the various economizer control methods and their benefits, as well as sensors required to accomplish your application goals. Please contact your local Carrier representative for assistance.

Motor limits, break horsepower (BHP):

Due to Carrier's internal unit design, air path, and specially designed motors, the full horsepower (maximum continuous BHP) band, as listed in Table 9 can be used with the utmost confidence. There is no need for extra safety factors, as Carrier's motors are designed and rigorously tested to use the entire, listed BHP range without either nuisance tripping or premature motor failure.

Sizing a rooftop

Bigger isn't necessarily better. While an air conditioner needs to have enough capacity to meet the load, it doesn't need excess capacity. In fact, having excess capacity typically results in very poor part load performance and humidity control.

Using higher design temperatures than ASHRAE recommends for your location, adding "safety factors" to the calculated load, and rounding up to the next largest unit, are all signs of oversizing air conditioners. Oversizing can cause short-cycling, and short cycling leads to poor humidity control, reduced efficiency, higher utility bills, drastic indoor temperature swings, excessive noise, and increased wear and tear on the air conditioner.

Rather than oversizing an air conditioner, wise contractors and engineers "right-size" or even slightly undersize air conditioners. Correctly sizing an air conditioner controls humidity better; promotes efficiency; reduces utility bills; extends equipment life, and maintains even, comfortable temperatures.

COOLING CAPACITIES

Table 11 – COOLING CAPACITIES - FIRST STAGE, PART LOAD

12.5 TONS

14 SIZE				AMBIENT TEMPERATURE															
				85°F			95°F			105°F			115°F			125°F			
				EAT (db)			EAT (db)			EAT (db)			EAT (db)			EAT (db)			
				75	80	85	75	80	85	75	80	85	75	80	85	75	80	85	
2000 Cfm	EAT (wb)	58	TC	58.0	58.0	66.0	54.1	54.1	61.9	50.2	50.2	57.6	46.0	46.0	53.1	41.7	41.7	48.6	
			SHC	49.9	58.0	66.0	46.3	54.1	61.9	42.7	50.2	57.6	38.9	46.0	53.1	35.0	41.7	48.6	
		62	TC	58.8	58.8	67.6	54.4	54.4	64.4	50.3	50.3	60.3	46.1	46.1	55.7	41.8	41.8	50.9	
			SHC	46.7	57.1	67.6	43.7	54.0	64.4	40.3	50.3	60.3	36.7	46.1	55.7	32.8	41.8	50.9	
		67	TC	65.8	65.8	65.8	60.9	60.9	60.9	56.1	56.1	56.1	50.9	50.9	50.9	45.6	45.6	46.8	
			SHC	37.5	48.1	58.7	34.7	45.2	55.8	31.8	42.3	52.8	28.8	39.3	49.8	25.7	36.3	46.8	
	72	TC	73.9	73.9	73.9	68.8	68.8	68.8	63.6	63.6	63.6	58.1	58.1	58.1	52.5	52.5	52.5		
		SHC	28.1	38.7	49.3	25.2	35.8	46.4	22.3	32.9	43.5	19.3	29.9	40.6	16.4	26.9	37.5		
	76	TC	-	80.9	80.9	-	75.5	75.5	-	69.9	69.9	-	64.2	64.2	-	58.2	58.2		
		SHC	-	31.0	41.7	-	28.1	38.8	-	25.3	35.9	-	22.2	33.0	-	19.3	29.9		
	2350 Cfm	EAT (wb)	58	TC	61.8	61.8	70.4	57.8	57.8	66.0	53.6	53.6	61.4	49.2	49.2	56.7	44.7	44.7	51.8
				SHC	53.3	61.8	70.4	49.6	57.8	66.0	45.7	53.6	61.4	41.7	49.2	56.7	37.6	44.7	51.8
62			TC	61.9	61.9	73.3	57.9	57.9	68.8	53.7	53.7	64.2	49.3	49.3	59.3	44.8	44.8	54.2	
			SHC	50.6	61.9	73.3	46.9	57.9	68.8	43.2	53.7	64.2	39.3	49.3	59.3	35.3	44.8	54.2	
67			TC	67.8	67.8	67.8	62.8	62.8	62.8	57.7	57.7	59.4	52.5	52.5	56.4	47.0	47.0	53.1	
			SHC	40.8	53.0	65.3	37.8	50.1	62.4	34.9	47.1	59.4	31.9	44.1	56.4	28.8	41.0	53.1	
72		TC	76.1	76.1	76.1	70.7	70.7	70.7	65.2	65.2	65.2	59.6	59.6	59.6	53.7	53.7	53.7		
		SHC	29.5	41.9	54.3	26.6	39.0	51.4	23.7	36.1	48.4	20.8	33.1	45.4	17.6	30.0	42.3		
76		TC	-	83.1	83.1	-	77.4	77.4	-	71.7	71.7	-	65.7	65.7	-	59.6	59.6		
		SHC	-	32.9	45.3	-	29.9	42.4	-	27.0	39.4	-	24.0	36.4	-	21.0	33.3		
2700 Cfm		EAT (wb)	58	TC	65.0	65.0	73.9	60.8	60.8	69.3	56.5	56.5	64.5	51.9	51.9	59.6	47.1	47.1	54.4
				SHC	56.2	65.0	73.9	52.3	60.8	69.3	48.3	56.5	64.5	44.1	51.9	59.6	39.8	47.1	54.4
	62		TC	65.1	65.1	77.0	60.8	60.8	72.2	56.5	56.5	67.4	51.9	51.9	62.3	47.2	47.2	56.9	
			SHC	53.3	65.1	77.0	49.5	60.8	72.2	45.6	56.5	67.4	41.5	51.9	62.3	37.3	47.2	56.9	
	67		TC	69.3	69.3	71.8	64.3	64.3	68.7	59.0	59.0	65.6	53.6	53.6	62.4	48.2	48.2	59.1	
			SHC	43.8	57.8	71.8	40.9	54.8	68.7	37.8	51.7	65.6	34.7	48.6	62.4	31.5	45.2	59.1	
	72	TC	77.6	77.6	77.6	72.1	72.1	72.1	66.5	66.5	66.5	60.7	60.7	60.7	54.7	54.7	54.7		
		SHC	30.9	45.0	59.1	28.0	42.0	56.1	25.0	39.0	53.0	21.9	36.0	50.0	18.9	32.9	46.9		
	76	TC	-	84.6	84.6	-	78.8	78.8	-	72.9	72.9	-	66.9	66.9	-	60.5	60.5		
		SHC	-	34.5	48.7	-	31.6	45.7	-	28.6	42.7	-	25.5	39.7	-	22.4	36.5		
	3050 Cfm	EAT (wb)	58	TC	67.8	67.8	76.9	63.3	63.3	72.2	58.8	58.8	67.2	54.0	54.0	62.0	49.0	49.0	56.6
				SHC	58.6	67.8	76.9	54.5	63.3	72.2	50.3	58.8	67.2	46.0	54.0	62.0	41.5	49.0	56.6
62			TC	67.9	67.9	80.0	63.4	63.4	75.2	58.8	58.8	70.1	54.1	54.1	64.7	49.1	49.1	59.3	
			SHC	55.6	67.9	80.0	51.7	63.4	75.2	47.6	58.8	70.1	43.4	54.1	64.7	39.0	49.1	59.3	
67			TC	70.6	70.6	77.8	65.4	65.4	74.7	60.2	60.2	71.4	54.8	54.8	68.0	49.4	49.4	63.7	
			SHC	46.7	62.2	77.8	43.7	59.2	74.7	40.6	56.0	71.4	37.3	52.7	68.0	33.8	48.8	63.7	
72		TC	78.8	78.8	78.8	73.2	73.2	73.2	67.5	67.5	67.5	61.5	61.5	61.5	55.5	55.5	55.5		
		SHC	32.2	47.9	63.7	29.3	44.9	60.6	26.2	41.8	57.5	23.1	38.8	54.5	20.0	35.7	51.3		
76		TC	-	85.9	85.9	-	80.0	80.0	-	73.9	73.9	-	67.7	67.7	-	61.3	61.3		
		SHC	-	36.1	51.9	-	33.2	48.8	-	30.1	45.8	-	27.0	42.7	-	23.9	39.6		
3350 Cfm		EAT (wb)	58	TC	69.7	69.7	79.1	65.1	65.1	74.2	60.5	60.5	69.0	55.6	55.6	63.8	50.5	50.5	58.3
				SHC	60.4	69.7	79.1	56.2	65.1	74.2	51.9	60.5	69.0	47.4	55.6	63.8	42.8	50.5	58.3
	62		TC	69.8	69.8	82.4	65.2	65.2	77.3	60.5	60.5	72.1	55.7	55.7	66.6	50.6	50.6	60.9	
			SHC	57.2	69.8	82.4	53.2	65.2	77.3	49.0	60.5	72.1	44.8	55.7	66.6	40.3	50.6	60.9	
	67		TC	71.6	71.6	82.7	66.4	66.4	79.5	61.1	61.1	75.9	55.9	55.9	71.8	50.7	50.7	66.2	
			SHC	48.9	65.8	82.7	45.9	62.7	79.5	42.7	59.3	75.9	39.3	55.6	71.8	35.2	50.7	66.2	
	72	TC	79.6	79.6	79.6	73.9	73.9	73.9	68.2	68.2	68.2	62.1	62.1	62.1	56.0	56.0	56.0		
		SHC	33.2	50.3	67.4	30.2	47.3	64.4	27.1	44.2	61.2	24.1	41.1	58.1	21.0	37.9	54.9		
	76	TC	-	86.8	86.8	-	80.7	80.7	-	74.6	74.6	-	68.3	68.3	-	61.8	61.8		
		SHC	-	37.3	54.5	-	34.3	51.5	-	31.3	48.4	-	28.2	45.2	-	25.1	42.0		

LEGEND:

- Do not operate
- Cfm - Cubic feet per minute (supply air)
- EAT (db) - Entering Air Temperature (dry bulb)
- EAT (wb) - Entering Air Temperature (wet bulb)
- SHC - Sensible Heat Capacity (1000 Btuh) Gross
- TC - Total Capacity (1000 Btuh) Gross

Table 12 – COOLING CAPACITIES - SECOND STAGE, PART LOAD

12.5 TONS

14 SIZE			AMBIENT TEMPERATURE																
			85°F			95°F			105°F			115°F			125°F				
			EAT (db)			EAT (db)			EAT (db)			EAT (db)			EAT (db)				
			75	80	85	75	80	85	75	80	85	75	80	85	75	80	85		
3000 Cfm	EAT (wb)	58	TC	76.5	76.5	88.1	69.1	69.1	80.2	61.5	61.5	72.2	53.7	53.7	63.9	45.6	45.6	55.3	
			SHC	64.9	76.5	88.1	57.9	69.1	80.2	50.8	61.5	72.2	43.5	53.7	63.9	36.0	45.6	55.3	
		62	TC	76.6	76.6	92.1	69.2	69.2	84.1	61.6	61.6	75.9	53.8	53.8	67.5	45.7	45.7	58.7	
			SHC	61.2	76.6	92.1	54.3	69.2	84.1	47.3	61.6	75.9	40.2	53.8	67.5	32.9	45.7	58.7	
		67	TC	86.9	86.9	86.9	78.0	78.0	78.0	68.9	68.9	68.9	59.7	59.7	61.6	50.2	50.2	55.3	
			SHC	48.4	64.3	80.0	42.2	58.1	74.0	36.1	52.0	67.9	29.9	45.7	61.6	23.6	39.5	55.3	
	72	TC	99.1	99.1	99.1	89.8	89.8	89.8	80.2	80.2	80.2	70.5	70.5	70.5	60.5	60.5	60.5		
		SHC	35.0	51.0	67.0	29.0	44.9	60.8	22.8	38.8	54.7	16.7	32.6	48.5	10.4	26.3	42.2		
	76	TC	-	109.5	109.5	-	99.8	99.8	-	90.0	90.0	-	79.8	79.8	-	69.2	69.2		
		SHC	-	40.2	56.3	-	34.1	50.2	-	28.0	44.1	-	21.8	37.8	-	15.5	31.6		
	3500 Cfm	EAT (wb)	58	TC	82.1	82.1	94.3	74.3	74.3	86.0	66.3	66.3	77.5	58.1	58.1	68.7	49.7	49.7	59.8
				SHC	69.9	82.1	94.3	62.6	74.3	86.0	55.1	66.3	77.5	47.5	58.1	68.7	39.6	49.7	59.8
62			TC	82.2	82.2	98.5	74.4	74.4	90.0	66.4	66.4	81.3	58.2	58.2	72.4	49.8	49.8	63.3	
			SHC	66.0	82.2	98.5	58.8	74.4	90.0	51.5	66.4	81.3	44.0	58.2	72.4	36.3	49.8	63.3	
67			TC	89.6	89.6	89.8	80.4	80.4	83.6	71.2	71.2	77.3	61.7	61.7	70.9	52.0	52.0	64.4	
			SHC	53.1	71.5	89.8	46.9	65.2	83.6	40.7	59.0	77.3	34.3	52.7	70.9	27.9	46.1	64.4	
72		TC	101.8	101.8	101.8	92.2	92.2	92.2	82.5	82.5	82.5	72.3	72.3	72.3	62.0	62.0	62.0		
		SHC	37.3	55.8	74.2	31.1	49.6	68.1	24.9	43.4	61.8	18.6	37.1	55.5	12.3	30.6	49.0		
76		TC	-	112.4	112.4	-	102.4	102.4	-	92.2	92.2	-	81.7	81.7	-	70.9	70.9		
		SHC	-	43.0	61.6	-	36.8	55.4	-	30.6	49.1	-	24.3	42.8	-	17.9	36.4		
4000 Cfm		EAT (wb)	58	TC	86.7	86.7	99.3	78.6	78.6	90.7	70.3	70.3	81.9	61.8	61.8	72.7	53.0	53.0	63.4
				SHC	74.1	86.7	99.3	66.5	78.6	90.7	58.7	70.3	81.9	50.8	61.8	72.7	42.6	53.0	63.4
	62		TC	86.8	86.8	103.6	78.7	78.7	94.9	70.4	70.4	85.9	61.9	61.9	76.6	53.1	53.1	67.0	
			SHC	69.9	86.8	103.6	62.5	78.7	94.9	54.9	70.4	85.9	47.2	61.9	76.6	39.2	53.1	67.0	
	67		TC	91.7	91.7	99.2	82.5	82.5	92.7	73.0	73.0	86.3	63.4	63.4	79.6	53.6	53.6	72.5	
			SHC	57.6	78.4	99.2	51.3	72.1	92.7	44.9	65.6	86.3	38.5	59.0	79.6	31.9	52.2	72.5	
	72	TC	103.9	103.9	103.9	94.1	94.1	94.1	84.1	84.1	84.1	73.8	73.8	73.8	63.3	63.3	63.3		
		SHC	39.4	60.3	81.2	33.2	54.0	75.0	26.8	47.7	68.6	20.5	41.3	62.2	13.9	34.8	55.7		
	76	TC	-	114.6	114.6	-	104.3	104.3	-	93.9	93.9	-	83.2	83.2	-	72.2	72.2		
		SHC	-	45.5	66.6	-	39.3	60.4	-	33.0	53.9	-	26.5	47.5	-	20.1	41.0		
	4500 Cfm	EAT (wb)	58	TC	90.6	90.6	103.5	82.2	82.2	94.7	73.6	73.6	85.5	64.8	64.8	76.1	55.8	55.8	66.5
				SHC	77.5	90.6	103.5	69.7	82.2	94.7	61.7	73.6	85.5	53.5	64.8	76.1	45.0	55.8	66.5
62			TC	90.7	90.7	108.0	82.3	82.3	99.0	73.7	73.7	89.6	64.9	64.9	80.0	55.9	55.9	70.1	
			SHC	73.3	90.7	108.0	65.6	82.3	99.0	57.8	73.7	89.6	49.8	64.9	80.0	41.5	55.9	70.1	
67			TC	93.6	93.6	107.9	84.2	84.2	101.3	74.8	74.8	94.5	65.3	65.3	87.0	56.2	56.2	76.8	
			SHC	61.8	84.9	107.9	55.4	78.4	101.3	48.9	71.8	94.5	42.1	64.5	87.0	34.4	55.6	76.8	
72		TC	105.5	105.5	105.5	95.6	95.6	95.6	85.4	85.4	85.4	74.9	74.9	74.9	64.3	64.3	64.3		
		SHC	41.2	64.5	87.9	34.9	58.2	81.5	28.6	51.9	75.2	22.1	45.3	68.6	15.6	38.8	62.0		
76		TC	-	116.2	116.2	-	105.9	105.9	-	95.2	95.2	-	84.2	84.2	-	73.0	73.0		
		SHC	-	47.9	71.3	-	41.5	64.9	-	35.2	58.5	-	28.8	52.0	-	22.1	45.3		
4950 Cfm		EAT (wb)	58	TC	93.5	93.5	106.9	84.9	84.9	97.7	76.2	76.2	88.3	67.2	67.2	78.8	57.9	57.9	68.8
				SHC	80.2	93.5	106.9	72.2	84.9	97.7	64.1	76.2	88.3	55.7	67.2	78.8	47.0	57.9	68.8
	62		TC	93.6	93.6	111.4	85.1	85.1	102.1	76.3	76.3	92.5	67.3	67.3	82.7	58.0	58.0	72.5	
			SHC	75.9	93.6	111.4	68.1	85.1	102.1	60.1	76.3	92.5	51.9	67.3	82.7	43.4	58.0	72.5	
	67		TC	95.2	95.2	115.3	85.8	85.8	108.4	76.4	76.4	100.8	67.6	67.6	89.9	58.1	58.1	80.0	
			SHC	65.4	90.4	115.3	58.9	83.7	108.4	52.1	76.4	100.8	44.1	67.0	89.9	36.3	58.1	80.0	
	72	TC	106.7	106.7	106.7	96.6	96.6	96.6	86.3	86.3	86.3	75.8	75.8	75.8	64.9	64.9	67.6		
		SHC	42.9	68.3	93.7	36.5	61.9	87.3	30.1	55.5	80.8	23.6	48.9	74.3	17.1	42.3	67.6		
	76	TC	-	117.4	117.4	-	107.0	107.0	-	96.1	96.1	-	85.1	85.1	-	73.7	73.7		
		SHC	-	49.9	75.4	-	43.5	69.0	-	37.1	62.5	-	30.5	55.9	-	24.0	49.1		

LEGEND:

- - Do not operate
- Cfm - Cubic feet per minute (supply air)
- EAT (db) - Entering Air Temperature (dry bulb)
- EAT (wb) - Entering Air Temperature (wet bulb)
- SHC - Sensible Heat Capacity (1000 Btuh) Gross
- TC - Total Capacity (1000 Btuh) Gross

Table 13 – COOLING CAPACITIES - THIRD STAGE, FULL LOAD

12.5 TONS

14 SIZE			AMBIENT TEMPERATURE																
			85°F			95°F			105°F			115°F			125°F				
			EAT (db)			EAT (db)			EAT (db)			EAT (db)			EAT (db)				
			75	80	85	75	80	85	75	80	85	75	80	85	75	80	85		
3750 Cfm	EAT (wb)	58	TC	127.7	127.7	145.1	120.8	120.8	137.6	113.6	113.6	129.6	106.0	106.0	121.3	98.0	98.0	112.6	
			SHC	110.4	127.7	145.1	104.0	120.8	137.6	97.5	113.6	129.6	90.6	106.0	121.3	83.5	98.0	112.6	
		62	TC	133.7	133.7	138.8	125.3	125.3	133.7	116.6	116.6	128.3	107.6	107.6	122.8	98.9	98.9	116.2	
			SHC	99.6	119.2	138.8	94.6	114.1	133.7	89.3	108.8	128.3	83.9	103.4	122.8	78.1	97.1	116.2	
		67	TC	148.2	148.2	148.2	139.2	139.2	139.2	129.8	129.8	129.8	120.1	120.1	120.1	110.0	110.0	110.0	
			SHC	81.6	101.3	121.0	76.5	96.2	115.9	71.4	91.1	110.8	66.1	85.8	105.4	60.6	80.3	99.9	
	72	TC	164.3	164.3	164.3	154.8	154.8	154.8	144.9	144.9	144.9	134.6	134.6	134.6	123.6	123.6	123.6		
		SHC	63.2	83.0	102.9	58.2	78.0	97.8	53.1	72.9	92.6	47.9	67.7	87.5	42.5	62.3	82.0		
	76	TC	-	177.9	177.9	-	168.0	168.0	-	157.7	157.7	-	146.6	146.6	-	-	-		
		SHC	-	68.0	88.0	-	63.1	83.2	-	58.0	78.1	-	52.8	72.9	-	-	-		
	4400 Cfm	EAT (wb)	58	TC	136.2	136.2	154.5	128.8	128.8	146.4	121.1	121.1	138.0	113.0	113.0	129.1	104.5	104.5	119.8
				SHC	117.9	136.2	154.5	111.2	128.8	146.4	104.1	121.1	138.0	96.8	113.0	129.1	89.1	104.5	119.8
62			TC	138.8	138.8	154.1	130.3	130.3	148.6	121.9	121.9	142.2	113.1	113.1	134.7	104.6	104.6	125.2	
			SHC	108.9	131.5	154.1	103.5	126.1	148.6	97.9	120.0	142.2	91.6	113.1	134.7	84.1	104.6	125.2	
67			TC	152.9	152.9	152.9	143.5	143.5	143.5	133.8	133.8	133.8	123.6	123.6	123.6	113.1	113.1	113.1	
			SHC	87.7	110.5	133.4	82.5	105.4	128.2	77.2	100.0	122.9	71.9	94.7	117.5	66.4	89.1	111.9	
72		TC	169.1	169.1	169.1	159.2	159.2	159.2	148.9	148.9	148.9	138.2	138.2	138.2	126.8	126.8	126.8		
		SHC	66.0	89.0	111.9	60.9	83.9	106.9	55.8	78.7	101.7	50.5	73.4	96.3	45.0	68.0	90.9		
76		TC	-	182.8	182.8	-	172.5	172.5	-	161.8	161.8	-	150.5	150.5	-	-	-		
		SHC	-	71.5	94.9	-	66.4	89.8	-	61.3	84.6	-	56.1	79.4	-	-	-		
5000 Cfm		EAT (wb)	58	TC	142.6	142.6	161.8	134.8	134.8	153.2	126.8	126.8	144.3	118.3	118.3	135.0	109.4	109.4	125.3
				SHC	123.6	142.6	161.8	116.5	134.8	153.2	109.2	126.8	144.3	101.5	118.3	135.0	93.5	109.4	125.3
	62		TC	143.2	143.2	166.7	135.0	135.0	159.5	126.9	126.9	150.4	118.5	118.5	140.8	109.6	109.6	130.8	
			SHC	116.6	141.7	166.7	110.5	135.0	159.5	103.4	126.9	150.4	96.0	118.5	140.8	88.3	109.6	130.8	
	67		TC	156.1	156.1	156.1	146.5	146.5	146.5	136.5	136.5	136.5	126.3	126.3	128.1	115.4	115.4	122.4	
			SHC	92.8	118.6	144.3	87.7	113.4	139.0	82.3	107.9	133.7	76.8	102.5	128.1	71.3	96.8	122.4	
	72	TC	172.4	172.4	172.4	162.2	162.2	162.2	151.6	151.6	151.6	140.6	140.6	140.6	129.1	129.1	129.1		
		SHC	68.3	94.2	120.0	63.2	89.0	114.9	58.0	83.8	109.6	52.7	78.4	104.1	47.1	72.8	98.6		
	76	TC	-	186.2	186.2	-	175.7	175.7	-	164.7	164.7	-	153.2	153.2	-	-	-		
		SHC	-	74.3	100.5	-	69.3	95.5	-	64.2	90.2	-	58.8	84.9	-	-	-		
	5650 Cfm	EAT (wb)	58	TC	148.5	148.5	168.3	140.3	140.3	159.3	131.9	131.9	150.1	123.0	123.0	140.4	113.9	113.9	130.3
				SHC	128.8	148.5	168.3	121.4	140.3	159.3	113.7	131.9	150.1	105.8	123.0	140.4	97.4	113.9	130.3
62			TC	148.7	148.7	175.1	140.5	140.5	165.8	132.0	132.0	156.3	123.2	123.2	146.3	114.0	114.0	135.9	
			SHC	122.3	148.7	175.1	115.1	140.5	165.8	107.7	132.0	156.3	100.0	123.2	146.3	92.0	114.0	135.9	
67			TC	159.0	159.0	159.0	149.3	149.3	150.2	139.0	139.0	144.8	128.5	128.5	139.1	117.6	117.6	133.2	
			SHC	98.2	126.9	155.6	92.9	121.6	150.2	87.6	116.1	144.8	82.0	110.6	139.1	76.3	104.8	133.2	
72		TC	175.2	175.2	175.2	164.8	164.8	164.8	154.1	154.1	154.1	142.7	142.7	142.7	130.9	130.9	130.9		
		SHC	70.6	99.5	128.3	65.5	94.3	123.1	60.3	89.0	117.8	54.8	83.6	112.3	49.2	78.0	106.7		
76		TC	-	189.2	189.2	-	178.3	178.3	-	167.1	167.1	-	155.4	155.4	-	-	-		
		SHC	-	77.2	106.5	-	72.2	101.3	-	67.0	96.0	-	61.6	90.7	-	-	-		
6250 Cfm		EAT (wb)	58	TC	153.1	153.1	173.4	144.7	144.7	164.2	135.9	135.9	154.5	126.8	126.8	144.6	117.3	117.3	134.1
				SHC	132.8	153.1	173.4	125.2	144.7	164.2	117.3	135.9	154.5	109.0	126.8	144.6	100.4	117.3	134.1
	62		TC	153.2	153.2	180.3	144.9	144.9	170.9	136.0	136.0	161.0	126.9	126.9	150.6	117.4	117.4	139.8	
			SHC	126.2	153.2	180.3	118.9	144.9	170.9	111.2	136.0	161.0	103.3	126.9	150.6	95.0	117.4	139.8	
	67		TC	161.3	161.3	165.8	151.3	151.3	160.3	141.0	141.0	154.6	130.4	130.4	148.8	119.4	119.4	142.5	
			SHC	103.0	134.4	165.8	97.6	129.0	160.3	92.1	123.4	154.6	86.6	117.7	148.8	80.7	111.6	142.5	
	72	TC	177.4	177.4	177.4	166.8	166.8	166.8	155.8	155.8	155.8	144.3	144.3	144.3	132.3	132.3	132.3		
		SHC	72.6	104.2	135.8	67.5	99.0	130.6	62.2	93.7	125.2	56.7	88.1	119.6	51.1	82.6	114.0		
	76	TC	-	191.4	191.4	-	180.4	180.4	-	169.0	169.0	-	157.1	157.1	-	-	-		
		SHC	-	79.9	111.7	-	74.7	106.6	-	69.4	101.3	-	64.1	95.8	-	-	-		

LEGEND:

- - Do not operate
- Cfm - Cubic feet per minute (supply air)
- EAT (db) - Entering Air Temperature (dry bulb)
- EAT (wb) - Entering Air Temperature (wet bulb)
- SHC - Sensible Heat Capacity (1000 Btuh) Gross
- TC - Total Capacity (1000 Btuh) Gross

50LC*A14 REHEAT MODE #1 CAPACITIES (MBTUH), STANDARD UNITS

Reheat-1 (Subcooler Mode)		AIR ENTERING EVAPORATOR - SCFM/BF (80db)								
		3750			5000			6250		
Outdoor Air Temp ° F		Air Entering Evaporator -- Ewb (F)								
		72	67	62	72	67	62	72	67	62
75	TC	165	148	135	173	158	146	179	164	153
	SHC	72	90	111	83	109	135	93	125	153
	kW	8.2	7.9	7.7	8.3	8.1	7.9	8.4	8.2	8.0
85	TC	156	142	130	163	149	138	168	155	144
	SHC	64	85	106	73	100	128	83	117	141
	kW	9.1	8.9	8.6	9.2	9.0	8.8	9.3	9.1	8.9
95	TC	147	132	123	154	140	129	158	144	135
	SHC	56	75	100	65	92	120	74	107	135
	kW	10.1	9.8	9.7	10.3	10.0	9.8	10.3	10.1	9.9
105	TC	138	123	114	145	131	121	148	134	126
	SHC	47	67	92	57	84	112	65	98	126
	kW	11.3	11.0	10.8	11.4	11.1	10.9	11.5	11.2	11.0
115	TC	129	116	107	133	122	112	137	125	117
	SHC	39	61	85	46	76	104	55	89	113
	kW	12.6	12.3	12.1	12.6	12.4	12.2	12.7	12.5	12.3
125	TC	119	108	99	124	112	104	127	115	108
	SHC	31	54	78	39	67	97	46	80	108
	kW	14.0	13.7	13.5	14.1	13.8	13.6	14.1	13.8	13.7

LEGEND AND NOTES

- kW --- Compressor Power Input
- SHC --- Sensible Heat Capacity (1000 Btuh) Gross
- TC --- Total Capacity (1000 Btuh) Gross

50LC*A14 REHEAT MODE #2 CAPACITIES (MBTUH), STANDARD UNITS

Reheat-2 (Hot Gas Reheat Mode)		AIR ENTERING EVAPORATOR - SCFM/BF (80db)								
		3750			5000			6250		
Outdoor Air Temp ° F		Air Entering Evaporator -- Ewb (F)								
		62.5	64	65.3	62.5	64	65.3	62.5	64	65.3
80	TC	52	53	54	54	55	56	55	56	58
	SHC	10	1	-6	20	9	1	31	19	8
	kW	11.2	11.4	11.5	11.3	11.4	11.6	11.3	11.5	11.6
75	TC	54	56	57	57	58	59	58	59	61
	SHC	12	4	-4	22	12	3	33	21	11
	kW	10.7	10.9	11.0	10.8	10.9	11.1	10.8	11.0	11.1
70	TC	57	58	60	59	61	62	61	62	63
	SHC	14	6	-1	25	14	6	36	24	14
	kW	10.2	10.4	10.5	10.3	10.5	10.6	10.4	10.5	10.6
60	TC	62	63	65	64	66	68	66	68	69
	SHC	19	11	4	29	19	11	40	29	19
	kW	9.4	9.5	9.6	9.4	9.6	9.7	9.5	9.6	9.8
50	TC	67	68	70	70	71	73	71	73	75
	SHC	23	15	8	34	24	16	45	34	24
	kW	8.6	8.7	8.8	8.7	8.8	8.9	8.7	8.9	9.0
40	TC	72	74	76	75	77	79	77	79	81
	SHC	28	20	14	39	30	21	51	40	30
	kW	7.9	8.0	8.1	8.0	8.1	8.2	8.1	8.2	8.3

LEGEND AND NOTES

- kW --- Compressor Power Input
- SHC --- Sensible Heat Capacity (1000 Btuh) Gross
- TC --- Total Capacity (1000 Btuh) Gross

Table 15 – COOLING CAPACITIES - FIRST STAGE, PART LOAD

15 TONS

17 SIZE			AMBIENT TEMPERATURE																
			85°F			95°F			105°F			115°F			125°F				
			EAT (db)			EAT (db)			EAT (db)			EAT (db)			EAT (db)				
			75	80	85	75	80	85	75	80	85	75	80	85	75	80	85		
2550 Cfm	EAT (wb)	58	TC	119.0	119.0	132.0	71.3	71.3	80.9	67.2	67.2	76.3	62.7	62.7	71.5	57.8	57.8	66.1	
			SHC	105.9	119.0	132.0	61.6	71.3	80.9	57.9	67.2	76.3	53.8	62.7	71.5	49.4	57.8	66.1	
		62	TC	75.3	75.3	88.4	71.4	71.4	84.2	67.3	67.3	79.6	62.8	62.8	74.5	57.9	57.9	69.0	
			SHC	61.7	75.1	88.4	58.5	71.4	84.2	54.9	67.3	79.6	51.0	62.8	74.5	46.8	57.9	69.0	
		67	TC	83.4	83.4	83.4	78.5	78.5	78.5	107.8	107.8	119.8	67.7	67.7	68.4	61.5	61.5	65.3	
			SHC	49.5	63.2	76.7	47.0	60.5	74.1	95.8	107.8	119.8	41.3	54.9	68.4	38.2	51.8	65.3	
	72	TC	93.0	93.0	93.0	87.8	87.8	87.8	82.3	82.3	82.3	76.2	76.2	76.2	69.7	69.7	69.7		
		SHC	37.0	50.6	64.3	34.3	48.0	61.7	31.7	45.3	59.0	28.8	42.4	56.1	25.7	39.4	53.0		
	76	TC	-	101.4	101.4	-	96.0	96.0	-	90.2	90.2	-	83.9	83.9	-	76.9	76.9		
		SHC	-	40.3	54.0	-	37.7	51.5	-	35.1	48.8	-	32.3	45.9	-	29.3	42.9		
	2950 Cfm	EAT (wb)	58	TC	79.2	79.2	89.7	75.2	75.2	85.3	208.3	208.3	208.3	66.1	66.1	75.3	121.4	121.4	121.4
				SHC	68.7	79.2	89.7	65.0	75.2	85.3	65.0	80.8	96.6	56.8	66.1	75.3	34.7	50.4	66.1
62			TC	79.3	79.3	93.3	75.3	75.3	88.8	70.9	70.9	83.9	66.2	66.2	78.5	61.0	61.0	72.6	
			SHC	65.3	79.3	93.3	61.8	75.3	88.8	58.0	70.9	83.9	53.8	66.2	78.5	49.4	61.0	72.6	
67			TC	85.4	85.4	85.4	80.4	80.4	81.8	75.1	75.1	79.1	69.2	69.2	76.1	63.0	63.0	72.8	
			SHC	53.2	68.9	84.5	50.6	66.2	81.8	47.9	63.5	79.1	44.9	60.5	76.1	41.7	57.3	72.8	
72		TC	95.2	95.2	95.2	89.9	89.9	89.9	84.0	84.0	84.0	77.9	77.9	77.9	71.1	71.1	71.1		
		SHC	38.6	54.3	70.1	36.0	51.7	67.5	33.2	48.9	64.6	30.3	46.0	61.8	27.3	43.0	58.7		
76		TC	-	103.7	103.7	-	98.2	98.2	-	92.0	92.0	-	85.5	85.5	-	78.4	78.4		
		SHC	-	42.4	58.2	-	39.9	55.7	-	37.1	52.9	-	34.3	50.1	-	31.3	47.1		
3400 Cfm		EAT (wb)	58	TC	83.1	83.1	94.0	78.9	78.9	89.4	74.3	74.3	84.3	69.3	69.3	78.9	63.9	63.9	72.9
				SHC	72.2	83.1	94.0	68.3	78.9	89.4	64.2	74.3	84.3	59.7	69.3	78.9	54.9	63.9	72.9
	62		TC	83.2	83.2	97.8	79.0	79.0	93.0	74.4	74.4	87.8	69.3	69.3	82.2	64.0	64.0	76.1	
			SHC	68.5	83.2	97.8	64.8	79.0	93.0	60.8	74.4	87.8	56.6	69.3	82.2	51.9	64.0	76.1	
	67		TC	87.3	87.3	92.9	82.2	82.2	90.2	76.7	76.7	87.3	70.8	70.8	84.1	64.5	64.5	80.6	
			SHC	57.2	75.1	92.9	54.5	72.3	90.2	51.7	69.5	87.3	48.7	66.4	84.1	45.4	63.0	80.6	
	72	TC	97.0	97.0	97.0	91.6	91.6	91.6	85.6	85.6	85.6	79.3	79.3	79.3	72.3	72.3	72.3		
		SHC	40.4	58.3	76.3	37.7	55.7	73.7	34.9	52.9	70.9	32.0	50.0	68.0	28.9	46.9	64.8		
	76	TC	-	105.6	105.6	-	99.9	99.9	-	93.7	93.7	-	87.0	87.0	-	79.7	79.7		
		SHC	-	44.7	62.9	-	42.0	60.3	-	39.3	57.4	-	36.4	54.5	-	33.3	51.5		
	3800 Cfm	EAT (wb)	58	TC	86.0	86.0	97.2	81.6	81.6	92.4	76.8	76.8	87.3	71.7	71.7	81.5	66.1	66.1	75.4
				SHC	74.7	86.0	97.2	70.7	81.6	92.4	66.4	76.8	87.3	61.8	71.7	81.5	56.7	66.1	75.4
62			TC	86.1	86.1	101.1	81.7	81.7	96.2	76.9	76.9	90.8	71.8	71.8	84.9	66.2	66.2	78.6	
			SHC	71.0	86.1	101.1	67.2	81.7	96.2	63.0	76.9	90.8	58.6	71.8	84.9	53.7	66.2	78.6	
67			TC	88.6	88.6	100.1	83.5	83.5	97.3	78.0	78.0	94.2	72.2	72.2	90.7	66.3	66.3	84.6	
			SHC	60.5	80.3	100.1	57.8	77.6	97.3	54.9	74.6	94.2	51.8	71.2	90.7	47.6	66.1	84.6	
72		TC	98.3	98.3	98.3	92.7	92.7	92.7	86.7	86.7	86.7	80.1	80.1	80.1	73.1	73.1	73.1		
		SHC	41.7	61.8	81.8	39.1	59.1	79.2	36.3	56.4	76.3	33.3	53.3	73.3	30.2	50.2	70.2		
76		TC	-	107.0	107.0	-	101.2	101.2	-	94.9	94.9	-	87.9	87.9	-	80.5	80.5		
		SHC	-	46.5	66.7	-	43.9	64.1	-	41.1	61.3	-	38.2	58.3	-	35.1	55.3		
4250 Cfm		EAT (wb)	58	TC	88.7	88.7	100.3	84.2	84.2	95.4	79.3	79.3	90.0	73.9	73.9	84.0	68.2	68.2	77.7
				SHC	77.1	88.7	100.3	73.0	84.2	95.4	68.6	79.3	90.0	63.9	73.9	84.0	58.6	68.2	77.7
	62		TC	88.8	88.8	104.3	84.3	84.3	99.3	79.4	79.4	93.6	74.0	74.0	87.6	68.3	68.3	81.0	
			SHC	73.3	88.8	104.3	69.4	84.3	99.3	65.1	79.4	93.6	60.5	74.0	87.6	55.5	68.3	81.0	
	67		TC	90.1	90.1	107.7	84.9	84.9	104.6	79.6	79.6	100.7	74.1	74.1	94.4	68.3	68.3	87.5	
			SHC	64.2	86.0	107.7	61.3	83.0	104.6	58.1	79.5	100.7	53.8	74.1	94.4	49.2	68.3	87.5	
	72	TC	99.4	99.4	99.4	93.7	93.7	93.7	87.7	87.7	87.7	81.0	81.0	81.0	73.9	73.9	76.1		
		SHC	43.3	65.5	87.8	40.7	62.9	85.1	37.8	60.1	82.3	34.8	57.0	79.3	31.7	53.8	76.1		
	76	TC	-	108.1	108.1	-	102.3	102.3	-	95.8	95.8	-	88.8	88.8	-	81.3	81.3		
		SHC	-	48.6	70.9	-	45.9	68.3	-	43.1	65.5	-	40.2	62.5	-	37.1	59.4		

LEGEND:

- - Do not operate
- Cfm - Cubic feet per minute (supply air)
- EAT (db) - Entering Air Temperature (dry bulb)
- EAT (wb) - Entering Air Temperature (wet bulb)
- SHC - Sensible Heat Capacity (1000 Btuh) Gross
- TC - Total Capacity (1000 Btuh) Gross

Table 16 – COOLING CAPACITIES - SECOND STAGE, PART LOAD

15 TONS

17 SIZE			AMBIENT TEMPERATURE																
			85°F			95°F			105°F			115°F			125°F				
			EAT (db)			EAT (db)			EAT (db)			EAT (db)			EAT (db)				
			75	80	85	75	80	85	75	80	85	75	80	85	75	80	85		
3700 Cfm	EAT (wb)	58	TC	110.2	110.2	124.5	104.9	104.9	118.7	99.6	99.6	112.8	94.2	94.2	106.7	88.3	88.3	100.2	
			SHC	95.8	110.2	124.5	91.2	104.9	118.7	86.5	99.6	112.8	81.6	94.2	106.7	76.4	88.3	100.2	
		62	TC	110.4	110.4	129.5	105.1	105.1	123.4	99.7	99.7	117.4	94.3	94.3	111.1	88.4	88.4	104.3	
			SHC	91.3	110.4	129.5	86.7	105.1	123.4	82.2	99.7	117.4	77.5	94.3	111.1	72.5	88.4	104.3	
		67	TC	120.7	120.7	120.7	113.8	113.8	113.8	107.0	107.0	107.0	100.0	100.0	102.4	92.6	92.6	99.0	
			SHC	73.0	92.6	112.1	69.8	89.3	108.9	66.6	86.2	105.7	63.4	82.9	102.4	60.1	79.6	99.0	
	72	TC	133.5	133.5	133.5	125.9	125.9	125.9	118.5	118.5	118.5	110.9	110.9	110.9	102.9	102.9	102.9		
		SHC	54.2	73.9	93.6	51.0	70.7	90.3	47.8	67.5	87.1	44.7	64.3	83.9	41.3	60.9	80.6		
	76	TC	-	144.5	144.5	-	136.4	136.4	-	128.3	128.3	-	120.2	120.2	-	111.8	111.8		
		SHC	-	58.6	78.5	-	55.4	75.3	-	52.3	72.1	-	49.0	68.8	-	45.8	65.5		
	4300 Cfm	EAT (wb)	58	TC	115.8	115.8	130.8	110.2	110.2	124.5	104.4	104.4	118.2	98.6	98.6	111.7	92.4	92.4	104.8
				SHC	100.8	115.8	130.8	95.7	110.2	124.5	90.8	104.4	118.2	85.5	98.6	111.7	80.0	92.4	104.8
62			TC	115.9	115.9	136.0	110.3	110.3	129.5	104.6	104.6	122.9	98.8	98.8	116.2	92.5	92.5	109.1	
			SHC	95.9	115.9	136.0	91.1	110.3	129.5	86.2	104.6	122.9	81.2	98.8	116.2	76.0	92.5	109.1	
67			TC	123.5	123.5	123.5	116.3	116.3	120.0	109.3	109.3	116.7	102.1	102.1	113.3	94.6	94.6	109.7	
			SHC	78.3	100.8	123.3	75.0	97.5	120.0	71.7	94.2	116.7	68.4	90.9	113.3	64.9	87.4	109.7	
72		TC	136.3	136.3	136.3	128.4	128.4	128.4	120.6	120.6	120.6	112.8	112.8	112.8	104.6	104.6	104.6		
		SHC	56.5	79.2	101.9	53.1	75.9	98.5	49.9	72.6	95.3	46.7	69.3	92.0	43.4	66.0	88.6		
76		TC	-	147.4	147.4	-	139.0	139.0	-	130.7	130.7	-	122.4	122.4	-	113.7	113.7		
		SHC	-	61.5	84.4	-	58.2	81.0	-	55.0	77.8	-	51.8	74.6	-	48.5	71.2		
4900 Cfm		EAT (wb)	58	TC	120.4	120.4	136.0	114.5	114.5	129.4	108.4	108.4	122.7	102.3	102.3	115.8	95.7	95.7	108.5
				SHC	104.9	120.4	136.0	99.5	114.5	129.4	94.2	108.4	122.7	88.7	102.3	115.8	83.0	95.7	108.5
	62		TC	120.6	120.6	141.4	114.6	114.6	134.5	108.5	108.5	127.5	102.4	102.4	120.5	95.8	95.8	112.9	
			SHC	99.8	120.6	141.4	94.7	114.6	134.5	89.5	108.5	127.5	84.3	102.4	120.5	78.8	95.8	112.9	
	67		TC	125.7	125.7	134.1	118.4	118.4	130.7	111.2	111.2	127.1	103.9	103.9	123.4	96.4	96.4	119.3	
			SHC	83.3	108.7	134.1	79.9	105.2	130.7	76.5	101.8	127.1	73.1	98.3	123.4	69.5	94.5	119.3	
	72	TC	138.5	138.5	138.5	130.3	130.3	130.3	122.3	122.3	122.3	114.3	114.3	114.3	105.9	105.9	105.9		
		SHC	58.5	84.1	109.8	55.2	80.8	106.5	52.0	77.5	103.2	48.7	74.3	99.8	45.3	70.9	96.4		
	76	TC	-	149.7	149.7	-	141.0	141.0	-	132.4	132.4	-	123.8	123.8	-	115.0	115.0		
		SHC	-	64.2	90.0	-	60.8	86.7	-	57.6	83.4	-	54.3	80.0	-	51.0	76.7		
	5550 Cfm	EAT (wb)	58	TC	124.7	124.7	140.8	118.4	118.4	133.7	112.0	112.0	126.7	105.6	105.6	119.5	98.8	98.8	111.9
				SHC	108.6	124.7	140.8	103.0	118.4	133.7	97.4	112.0	126.7	91.7	105.6	119.5	85.6	98.8	111.9
62			TC	124.8	124.8	146.3	118.5	118.5	138.9	112.1	112.1	131.7	105.7	105.7	124.3	98.9	98.9	116.4	
			SHC	103.4	124.8	146.3	97.9	118.5	138.9	92.5	112.1	131.7	87.1	105.7	124.3	81.2	98.9	116.4	
67			TC	127.7	127.7	145.2	120.3	120.3	141.4	113.0	113.0	137.5	106.0	106.0	132.8	99.2	99.2	124.5	
			SHC	88.3	116.8	145.2	84.8	113.1	141.4	81.4	109.4	137.5	77.5	105.2	132.8	72.3	98.4	124.5	
72		TC	140.2	140.2	140.2	131.8	131.8	131.8	123.6	123.6	123.6	115.4	115.4	115.4	107.0	107.0	107.0		
		SHC	60.6	89.4	118.2	57.2	86.0	114.8	54.0	82.7	111.3	50.7	79.4	108.0	47.3	76.0	104.6		
76		TC	-	151.5	151.5	-	142.6	142.6	-	133.9	133.9	-	125.1	125.1	-	116.1	116.1		
		SHC	-	67.0	95.8	-	63.6	92.4	-	60.3	89.1	-	56.9	85.8	-	53.6	82.4		
6150 Cfm		EAT (wb)	58	TC	128.0	128.0	144.4	121.4	121.4	137.1	114.9	114.9	129.8	108.1	108.1	122.4	101.1	101.1	114.6
				SHC	111.5	128.0	144.4	105.6	121.4	137.1	99.8	114.9	129.8	93.9	108.1	122.4	87.7	101.1	114.6
	62		TC	128.1	128.1	150.1	121.5	121.5	142.4	115.0	115.0	134.9	108.2	108.2	127.2	101.2	101.2	119.1	
			SHC	106.1	128.1	150.1	100.4	121.5	142.4	94.9	115.0	134.9	89.2	108.2	127.2	83.2	101.2	119.1	
	67		TC	129.5	129.5	154.6	122.1	122.1	150.3	115.2	115.2	144.2	108.5	108.5	136.0	101.3	101.3	128.2	
			SHC	92.7	123.7	154.6	89.1	119.7	150.3	84.7	114.5	144.2	79.6	107.7	136.0	74.4	101.3	128.2	
	72	TC	141.5	141.5	141.5	133.0	133.0	133.0	124.7	124.7	124.7	116.4	116.4	116.4	107.7	107.7	111.9		
		SHC	62.5	94.1	125.6	59.1	90.7	122.2	55.8	87.3	118.8	52.5	83.9	115.4	49.1	80.5	111.9		
	76	TC	-	152.9	152.9	-	143.8	143.8	-	134.9	134.9	-	126.1	126.1	-	116.9	116.9		
		SHC	-	69.3	101.1	-	66.0	97.6	-	62.7	94.3	-	59.3	90.9	-	56.0	87.5		

LEGEND:

- - Do not operate
- Cfm - Cubic feet per minute (supply air)
- EAT (db) - Entering Air Temperature (dry bulb)
- EAT (wb) - Entering Air Temperature (wet bulb)
- SHC - Sensible Heat Capacity (1000 Btuh) Gross
- TC - Total Capacity (1000 Btuh) Gross

Table 17 – COOLING CAPACITIES - THIRD STAGE, FULL LOAD

15 TONS

17 SIZE				AMBIENT TEMPERATURE															
				85°F			95°F			105°F			115°F			125°F			
				EAT (db)			EAT (db)			EAT (db)			EAT (db)			EAT (db)			
				75	80	85	75	80	85	75	80	85	75	80	85	75	80	85	
4500 Cfm	EAT (wb)	58	TC	156.8	156.8	177.9	148.6	148.6	169.1	139.9	139.9	159.6	130.7	130.7	149.5	120.9	120.9	138.7	
			SHC	135.6	156.8	177.9	128.1	148.6	169.1	120.3	139.9	159.6	111.9	130.7	149.5	103.1	120.9	138.7	
		62	TC	164.6	164.6	169.4	154.6	154.6	163.2	144.2	144.2	157.0	133.3	133.3	150.3	121.8	121.8	143.0	
			SHC	122.2	145.8	169.4	116.1	139.7	163.2	109.9	133.4	157.0	103.4	126.8	150.3	96.5	119.7	143.0	
		67	TC	182.6	182.6	182.6	171.8	171.8	171.8	160.6	160.6	160.6	148.7	148.7	148.7	136.1	136.1	136.1	
			SHC	100.4	124.1	147.8	94.4	118.1	141.8	88.2	111.9	135.6	81.9	105.5	129.2	75.3	98.9	122.6	
	72	TC	202.4	202.4	202.4	191.0	191.0	191.0	179.0	179.0	179.0	166.4	166.4	166.4	153.0	153.0	153.0		
		SHC	78.1	102.0	125.9	72.2	96.0	119.8	66.1	89.9	113.8	59.9	83.7	107.4	53.3	77.1	100.9		
	76	TC	-	219.3	219.3	-	207.1	207.1	-	194.5	194.5	-	181.2	181.2	-	167.1	167.1		
		SHC	-	83.8	107.9	-	77.9	102.0	-	71.9	96.0	-	65.6	89.8	-	59.3	83.5		
	5250 Cfm	EAT (wb)	58	TC	166.9	166.9	189.3	158.1	158.1	179.8	149.0	149.0	169.7	139.2	139.2	159.0	128.8	128.8	147.5
				SHC	144.6	166.9	189.3	136.6	158.1	179.8	128.3	149.0	169.7	119.5	139.2	159.0	110.1	128.8	147.5
62			TC	170.8	170.8	187.4	160.6	160.6	181.0	150.1	150.1	174.1	139.4	139.4	165.8	129.0	129.0	154.0	
			SHC	133.0	160.2	187.4	126.8	153.9	181.0	120.3	147.2	174.1	113.1	139.4	165.8	103.9	129.0	154.0	
67			TC	188.4	188.4	188.4	177.2	177.2	177.2	165.4	165.4	165.4	153.1	153.1	153.1	140.0	140.0	140.0	
			SHC	107.5	134.9	162.3	101.4	128.8	156.2	95.2	122.6	149.9	88.6	116.0	143.4	81.9	109.2	136.6	
72		TC	208.4	208.4	208.4	196.4	196.4	196.4	184.0	184.0	184.0	170.8	170.8	170.8	157.0	157.0	157.0		
		SHC	81.5	109.1	136.6	75.5	103.0	130.6	69.3	96.8	124.3	62.9	90.4	117.9	56.4	83.8	111.2		
76		TC	-	225.1	225.1	-	212.6	212.6	-	199.5	199.5	-	185.5	185.5	-	170.9	170.9		
		SHC	-	87.9	116.1	-	81.9	110.0	-	75.9	103.7	-	69.4	97.3	-	62.9	90.7		
6000 Cfm		EAT (wb)	58	TC	175.4	175.4	198.8	166.2	166.2	188.7	156.5	156.5	178.0	146.2	146.2	166.7	135.2	135.2	154.7
				SHC	152.1	175.4	198.8	143.7	166.2	188.7	134.9	156.5	178.0	125.7	146.2	166.7	115.7	135.2	154.7
	62		TC	176.5	176.5	204.0	166.3	166.3	196.4	156.7	156.7	185.4	146.3	146.3	173.8	135.4	135.4	161.4	
			SHC	143.0	173.6	204.0	136.3	166.3	196.4	127.8	156.7	185.4	119.0	146.3	173.8	109.4	135.4	161.4	
	67		TC	192.8	192.8	192.8	181.3	181.3	181.3	169.2	169.2	169.2	156.6	156.6	156.9	143.2	143.2	150.0	
			SHC	114.2	145.2	176.2	108.0	138.9	169.9	101.6	132.6	163.5	95.1	126.0	156.9	88.2	119.1	150.0	
	72	TC	212.8	212.8	212.8	200.5	200.5	200.5	187.7	187.7	187.7	174.2	174.2	174.2	159.9	159.9	159.9		
		SHC	84.5	115.7	146.8	78.4	109.5	140.7	72.2	103.3	134.4	65.7	96.7	127.8	59.1	90.0	121.0		
	76	TC	-	229.7	229.7	-	216.6	216.6	-	203.3	203.3	-	189.2	189.2	-	173.8	173.8		
		SHC	-	91.7	123.3	-	85.6	117.1	-	79.4	110.9	-	72.9	104.3	-	66.2	97.5		
	6750 Cfm	EAT (wb)	58	TC	182.5	182.5	206.7	172.8	172.8	196.1	162.6	162.6	185.0	152.0	152.0	173.3	140.6	140.6	160.7
				SHC	158.3	182.5	206.7	149.6	172.8	196.1	140.4	162.6	185.0	130.7	152.0	173.3	120.5	140.6	160.7
62			TC	182.7	182.7	215.1	173.0	173.0	204.1	162.8	162.8	192.7	152.2	152.2	180.5	140.8	140.8	167.6	
			SHC	150.4	182.7	215.1	142.0	173.0	204.1	133.1	162.8	192.7	123.8	152.2	180.5	114.0	140.8	167.6	
67			TC	196.4	196.4	196.4	184.5	184.5	184.5	172.3	172.3	176.7	159.4	159.4	169.8	145.8	145.8	162.7	
			SHC	120.5	155.0	189.5	114.2	148.7	183.1	107.8	142.3	176.7	101.2	135.5	169.8	94.3	128.5	162.7	
72		TC	216.4	216.4	216.4	203.7	203.7	203.7	190.6	190.6	190.6	176.8	176.8	176.8	162.2	162.2	162.2		
		SHC	87.3	122.0	156.6	81.1	115.7	150.3	74.8	109.4	143.9	68.3	102.8	137.3	61.5	96.0	130.5		
76		TC	-	233.3	233.3	-	220.0	220.0	-	206.1	206.1	-	191.7	191.7	-	176.1	176.1		
		SHC	-	95.1	130.3	-	88.9	123.9	-	82.7	117.6	-	76.1	111.0	-	69.3	103.9		
7500 Cfm		EAT (wb)	58	TC	188.5	188.5	213.3	178.4	178.4	202.4	167.9	167.9	190.8	156.9	156.9	178.6	145.1	145.1	165.7
				SHC	163.6	188.5	213.3	154.5	178.4	202.4	145.1	167.9	190.8	135.1	156.9	178.6	124.5	145.1	165.7
	62		TC	188.7	188.7	221.9	178.6	178.6	210.6	168.1	168.1	198.7	157.1	157.1	186.1	145.3	145.3	172.8	
			SHC	155.5	188.7	221.9	146.7	178.6	210.6	137.6	168.1	198.7	127.9	157.1	186.1	117.8	145.3	172.8	
	67		TC	199.3	199.3	202.5	187.3	187.3	196.0	174.8	174.8	189.2	161.9	161.9	182.2	148.2	148.2	174.7	
			SHC	126.6	164.5	202.5	120.2	158.1	196.0	113.7	151.5	189.2	107.0	144.6	182.2	99.8	137.3	174.7	
	72	TC	219.2	219.2	219.2	206.3	206.3	206.3	193.0	193.0	193.0	178.9	178.9	178.9	164.1	164.1	164.1		
		SHC	89.9	128.0	166.0	83.7	121.7	159.7	77.3	115.2	153.3	70.8	108.6	146.5	64.0	101.8	139.6		
	76	TC	-	236.1	236.1	-	222.6	222.6	-	208.6	208.6	-	193.8	193.8	-	177.8	177.8		
		SHC	-	98.4	136.9	-	92.1	130.5	-	85.8	124.0	-	79.3	117.3	-	72.3	110.2		

LEGEND:

- - Do not operate
- Cfm - Cubic feet per minute (supply air)
- EAT (db) - Entering Air Temperature (dry bulb)
- EAT (wb) - Entering Air Temperature (wet bulb)
- SHC - Sensible Heat Capacity (1000 Btuh) Gross
- TC - Total Capacity (1000 Btuh) Gross

50LC*A17 REHEAT MODE #1 CAPACITIES (MBTUH), STANDARD UNITS

Reheat-1 (Subcooler Mode)		AIR ENTERING EVAPORATOR - SCFM/BF (80db)								
		4500			6000			7500		
Outdoor Air Temp ° F		Air Entering Evaporator -- Ewb (F)								
		72	67	62	72	67	62	72	67	62
75	TC	207	187	167	217	198	180	225	205	189
	SHC	95	116	137	107	137	164	120	155	189
	kW	10.1	9.9	9.6	10.1	10.0	9.8	10.2	10.0	9.9
85	TC	190	175	157	206	186	168	212	186	173
	SHC	79	106	128	98	126	154	109	138	173
	kW	11.0	10.9	10.7	11.3	11.0	10.8	11.3	10.9	10.8
95	TC	173	163	146	192	173	157	192	180	165
	SHC	64	95	117	85	114	143	90	132	165
	kW	12.1	12.1	11.9	12.5	12.2	12.0	12.3	12.3	12.1
105	TC	169	151	135	179	160	145	185	166	153
	SHC	61	84	107	73	102	132	84	120	153
	kW	13.7	13.4	13.2	13.8	13.6	13.4	13.9	13.6	13.5
115	TC	156	138	123	165	147	132	170	152	140
	SHC	49	72	96	60	90	120	71	107	140
	kW	15.2	14.9	14.7	15.3	15.1	14.8	15.4	15.1	15.0
125	TC	142	125	110	150	133	118	155	138	126
	SHC	37	60	85	47	78	108	57	94	126
	kW	16.9	16.6	16.3	17.0	16.7	16.5	17.1	16.8	16.6

LEGEND AND NOTES

- kW --- Compressor Power Input
- SHC --- Sensible Heat Capacity (1000 Btuh) Gross
- TC --- Total Capacity (1000 Btuh) Gross

50LC*A17 REHEAT MODE #2 CAPACITIES (MBTUH), STANDARD UNITS

Reheat-2 (Hot Gas Reheat Mode)		AIR ENTERING EVAPORATOR - SCFM/BF (80db)								
		4500			6000			7500		
Outdoor Air Temp ° F		Air Entering Evaporator -- Ewb (F)								
		62.5	64	65.3	62.5	64	65.3	62.5	64	65.3
80	TC	69	72	74	72	75	77	74	77	79
	SHC	16	8	0	28	17	8	41	28	17
	kW	12.6	12.8	12.9	12.7	12.9	13.0	12.8	12.9	13.0
75	TC	74	77	79	77	80	83	79	82	85
	SHC	21	12	5	33	22	13	46	33	22
	kW	12.1	12.2	12.3	12.2	12.3	12.4	12.3	12.4	12.5
70	TC	79	82	84	82	85	88	85	87	90
	SHC	26	17	10	38	27	18	51	38	27
	kW	11.6	11.7	11.8	11.7	11.8	11.9	11.7	11.9	12.0
60	TC	88	91	94	92	96	98	95	98	101
	SHC	35	27	19	48	37	28	61	48	37
	kW	10.6	10.7	10.9	10.7	10.8	11.0	10.8	10.9	11.0
50	TC	98	102	104	103	106	109	106	109	112
	SHC	45	37	30	58	48	39	71	59	48
	kW	9.8	9.9	10.1	9.9	10.1	10.2	10.0	10.1	10.2
40	TC	108	112	115	113	117	120	116	120	123
	SHC	55	47	41	69	59	50	83	71	60
	kW	9.1	9.3	9.4	9.3	9.4	9.5	9.3	9.5	9.6

LEGEND AND NOTES

- kW --- Compressor Power Input
- SHC --- Sensible Heat Capacity (1000 Btuh) Gross
- TC --- Total Capacity (1000 Btuh) Gross

Table 19 – COOLING CAPACITIES - FIRST STAGE, PART LOAD

17.5 TONS

20 SIZE			AMBIENT TEMPERATURE																
			85°F			95°F			105°F			115°F			125°F				
			EAT (db)			EAT (db)			EAT (db)			EAT (db)			EAT (db)				
			75	80	85	75	80	85	75	80	85	75	80	85	75	80	85		
2750 Cfm	EAT (wb)	58	TC	92.1	92.1	104.1	88.5	88.5	100.0	84.6	84.6	95.7	80.4	80.4	91.1	76.0	76.0	86.1	
			SHC	80.1	92.1	104.1	76.9	88.5	100.0	73.5	84.6	95.7	69.8	80.4	91.1	65.8	76.0	86.1	
		62	TC	95.0	95.0	102.0	90.5	90.5	99.5	85.8	85.8	96.9	80.9	80.9	93.9	76.1	76.1	89.6	
			SHC	73.5	87.8	102.0	71.2	85.4	99.5	68.6	82.8	96.9	65.9	80.0	93.9	62.5	76.1	89.6	
		67	TC	104.3	104.3	104.3	99.5	99.5	99.5	94.4	94.4	94.4	88.8	88.8	88.8	83.1	83.1	83.1	
			SHC	59.9	74.2	88.6	57.6	72.0	86.3	55.3	69.6	83.9	52.7	67.1	81.4	50.1	64.4	78.8	
	72	TC	115.1	115.1	115.1	109.9	109.9	109.9	104.4	104.4	104.4	98.5	98.5	98.5	92.2	92.2	92.2		
		SHC	45.9	60.4	74.8	43.7	58.1	72.5	41.3	55.8	70.2	38.9	53.3	67.7	36.4	50.7	65.1		
	76	TC	-	124.1	124.1	-	118.8	118.8	-	112.9	112.9	-	106.7	106.7	-	99.9	99.9		
		SHC	-	49.0	63.8	-	46.8	61.5	-	44.5	59.2	-	42.1	56.6	-	39.5	54.1		
	3250 Cfm	EAT (wb)	58	TC	97.5	97.5	110.2	93.7	93.7	105.9	89.5	89.5	101.2	85.0	85.0	96.2	80.2	80.2	90.9
				SHC	84.9	97.5	110.2	81.4	93.7	105.9	77.8	89.5	101.2	73.8	85.0	96.2	69.6	80.2	90.9
62			TC	98.3	98.3	112.6	94.0	94.0	109.6	89.6	89.6	105.2	85.1	85.1	100.0	80.3	80.3	94.6	
			SHC	80.0	96.3	112.6	77.2	93.4	109.6	73.9	89.6	105.2	70.1	85.1	100.0	66.1	80.3	94.6	
67			TC	107.3	107.3	107.3	102.3	102.3	102.3	96.9	96.9	96.9	91.2	91.2	91.2	85.1	85.1	87.6	
			SHC	64.2	80.9	97.7	61.9	78.6	95.4	59.5	76.1	92.9	56.9	73.6	90.3	54.2	70.9	87.6	
72		TC	118.1	118.1	118.1	112.8	112.8	112.8	107.1	107.1	107.1	100.9	100.9	100.9	94.3	94.3	94.3		
		SHC	47.8	64.6	81.4	45.6	62.4	79.2	43.2	60.0	76.7	40.8	57.5	74.2	38.1	54.9	71.6		
76		TC	-	127.3	127.3	-	121.7	121.7	-	115.5	115.5	-	109.1	109.1	-	102.1	102.1		
		SHC	-	51.4	68.4	-	49.1	66.2	-	46.8	63.8	-	44.4	61.2	-	41.7	58.6		
3700 Cfm		EAT (wb)	58	TC	101.6	101.6	114.7	97.5	97.5	110.2	93.1	93.1	105.3	88.4	88.4	100.0	83.4	83.4	94.4
				SHC	88.4	101.6	114.7	84.8	97.5	110.2	80.9	93.1	105.3	76.7	88.4	100.0	72.3	83.4	94.4
	62		TC	101.7	101.7	119.1	97.6	97.6	114.5	93.2	93.2	109.5	88.4	88.4	104.0	83.5	83.5	98.2	
			SHC	84.1	101.7	119.1	80.6	97.6	114.5	76.9	93.2	109.5	72.9	88.4	104.0	68.7	83.5	98.2	
	67		TC	109.3	109.3	109.3	104.1	104.1	104.1	98.7	98.7	100.5	92.8	92.8	97.8	86.6	86.6	95.0	
			SHC	67.9	86.7	105.5	65.5	84.3	103.1	63.1	81.8	100.5	60.5	79.1	97.8	57.7	76.3	95.0	
	72	TC	120.2	120.2	120.2	114.7	114.7	114.7	108.8	108.8	108.8	102.5	102.5	102.5	95.7	95.7	95.7		
		SHC	49.3	68.3	87.2	47.1	66.0	84.8	44.8	63.6	82.4	42.2	61.0	79.9	39.6	58.4	77.1		
	76	TC	-	129.5	129.5	-	123.6	123.6	-	117.4	117.4	-	110.7	110.7	-	103.5	103.5		
		SHC	-	53.3	72.4	-	51.1	70.2	-	48.8	67.7	-	46.2	65.1	-	43.6	62.4		
	4150 Cfm	EAT (wb)	58	TC	105.0	105.0	118.6	100.7	100.7	113.8	96.1	96.1	108.7	91.3	91.3	103.3	86.0	86.0	97.4
				SHC	91.5	105.0	118.6	87.7	100.7	113.8	83.7	96.1	108.7	79.3	91.3	103.3	74.7	86.0	97.4
62			TC	105.1	105.1	123.1	100.8	100.8	118.3	96.2	96.2	113.0	91.4	91.4	107.3	86.1	86.1	101.3	
			SHC	87.0	105.1	123.1	83.4	100.8	118.3	79.6	96.2	113.0	75.4	91.4	107.3	71.0	86.1	101.3	
67			TC	111.0	111.0	112.9	105.7	105.7	110.5	100.1	100.1	107.8	94.2	94.2	105.0	87.9	87.9	102.0	
			SHC	71.3	92.1	112.9	68.9	89.7	110.5	66.4	87.2	107.8	63.8	84.3	105.0	60.9	81.4	102.0	
72		TC	121.8	121.8	121.8	116.2	116.2	116.2	110.2	110.2	110.2	103.7	103.7	103.7	96.8	96.8	96.8		
		SHC	50.8	71.8	92.6	48.6	69.4	90.3	46.1	67.0	87.8	43.6	64.4	85.2	41.0	61.7	82.5		
76		TC	-	131.1	131.1	-	125.2	125.2	-	118.8	118.8	-	111.9	111.9	-	104.6	104.6		
		SHC	-	55.2	76.2	-	52.9	73.9	-	50.5	71.5	-	48.0	68.8	-	45.2	66.1		
4600 Cfm		EAT (wb)	58	TC	107.9	107.9	121.9	103.5	103.5	117.0	98.8	98.8	111.6	93.7	93.7	106.0	88.3	88.3	99.9
				SHC	94.0	107.9	121.9	90.2	103.5	117.0	85.9	98.8	111.6	81.4	93.7	106.0	76.6	88.3	99.9
	62		TC	108.0	108.0	126.7	103.6	103.6	121.6	98.9	98.9	116.0	93.8	93.8	110.2	88.3	88.3	103.9	
			SHC	89.5	108.0	126.7	85.7	103.6	121.6	81.7	98.9	116.0	77.4	93.8	110.2	72.8	88.3	103.9	
	67		TC	112.3	112.3	120.0	107.1	107.1	117.5	101.4	101.4	114.7	95.5	95.5	111.7	89.2	89.2	108.2	
			SHC	74.6	97.3	120.0	72.2	94.9	117.5	69.6	92.1	114.7	66.9	89.3	111.7	63.9	86.1	108.2	
	72	TC	123.1	123.1	123.1	117.4	117.4	117.4	111.2	111.2	111.2	104.7	104.7	104.7	97.7	97.7	97.7		
		SHC	52.2	75.1	97.9	49.9	72.7	95.6	47.5	70.2	93.0	44.9	67.7	90.4	42.2	64.9	87.6		
	76	TC	-	132.5	132.5	-	126.5	126.5	-	119.9	119.9	-	112.9	112.9	-	105.5	105.5		
		SHC	-	56.9	80.0	-	54.6	77.5	-	52.2	75.0	-	49.6	72.3	-	46.9	69.5		

LEGEND:

- - Do not operate
- Cfm - Cubic feet per minute (supply air)
- EAT (db) - Entering Air Temperature (dry bulb)
- EAT (wb) - Entering Air Temperature (wet bulb)
- SHC - Sensible Heat Capacity (1000 Btuh) Gross
- TC - Total Capacity (1000 Btuh) Gross

Table 20 – COOLING CAPACITIES - SECOND STAGE, PART LOAD

17.5 TONS

20 SIZE			AMBIENT TEMPERATURE																
			85°F			95°F			105°F			115°F			125°F				
			EAT (db)			EAT (db)			EAT (db)			EAT (db)			EAT (db)				
			75	80	85	75	80	85	75	80	85	75	80	85	75	80	85		
3250 Cfm	EAT (wb)	58	TC	101.8	101.8	115.2	96.7	96.7	109.7	91.7	91.7	104.0	86.3	86.3	98.2	80.5	80.5	91.8	
			SHC	88.3	101.8	115.2	83.8	96.7	109.7	79.2	91.7	104.0	74.4	86.3	98.2	69.2	80.5	91.8	
		62	TC	103.9	103.9	115.2	97.9	97.9	111.5	92.0	92.0	107.5	86.4	86.4	102.3	80.6	80.6	95.7	
			SHC	81.9	98.6	115.2	78.4	95.0	111.5	74.7	91.2	107.5	70.5	86.4	102.3	65.5	80.6	95.7	
		67	TC	114.8	114.8	114.8	108.0	108.0	108.0	101.3	101.3	101.3	94.4	94.4	94.4	87.2	87.2	87.2	
			SHC	66.3	83.2	100.0	62.8	79.7	96.6	59.5	76.3	93.2	56.0	72.8	89.7	52.5	69.2	86.1	
	72	TC	127.2	127.2	127.2	119.8	119.8	119.8	112.5	112.5	112.5	105.1	105.1	105.1	97.3	97.3	97.3		
		SHC	50.2	67.2	84.2	46.8	63.8	80.7	43.4	60.4	77.3	40.0	56.9	73.8	36.5	53.3	70.3		
	76	TC	-	137.8	137.8	-	129.8	129.8	-	122.0	122.0	-	114.1	114.1	-	105.7	105.7		
		SHC	-	54.2	71.6	-	50.7	68.0	-	47.3	64.5	-	43.9	61.0	-	40.4	57.4		
	3800 Cfm	EAT (wb)	58	TC	107.6	107.6	121.8	102.1	102.1	115.7	96.6	96.6	109.7	91.0	91.0	103.4	84.9	84.9	96.7
				SHC	93.4	107.6	121.8	88.5	102.1	115.7	83.6	96.6	109.7	78.5	91.0	103.4	73.0	84.9	96.7
62			TC	107.9	107.9	126.2	102.3	102.3	120.4	96.7	96.7	114.2	91.1	91.1	107.7	85.0	85.0	100.8	
			SHC	88.5	107.3	126.2	84.0	102.3	120.4	79.3	96.7	114.2	74.4	91.1	107.7	69.2	85.0	100.8	
67			TC	117.8	117.8	117.8	110.8	110.8	110.8	103.7	103.7	103.7	96.6	96.6	99.3	89.2	89.2	95.5	
			SHC	71.0	90.5	109.9	67.5	86.9	106.4	64.0	83.4	102.9	60.5	79.9	99.3	56.8	76.1	95.5	
72		TC	130.5	130.5	130.5	122.7	122.7	122.7	115.1	115.1	115.1	107.3	107.3	107.3	99.3	99.3	99.3		
		SHC	52.4	71.9	91.5	48.8	68.3	87.8	45.3	64.8	84.3	41.9	61.3	80.8	38.3	57.7	77.2		
76		TC	-	141.0	141.0	-	132.7	132.7	-	124.5	124.5	-	116.2	116.2	-	107.6	107.6		
		SHC	-	56.7	76.6	-	53.2	73.0	-	49.7	69.4	-	46.2	65.9	-	42.7	62.2		
4300 Cfm		EAT (wb)	58	TC	112.0	112.0	126.7	106.2	106.2	120.3	100.4	100.4	114.0	94.5	94.5	107.3	88.1	88.1	100.3
				SHC	97.3	112.0	126.7	92.1	106.2	120.3	87.0	100.4	114.0	81.6	94.5	107.3	76.0	88.1	100.3
	62		TC	112.1	112.1	131.7	106.3	106.3	125.2	100.5	100.5	118.6	94.6	94.6	111.7	88.2	88.2	104.5	
			SHC	92.4	112.1	131.7	87.5	106.3	125.2	82.5	100.5	118.6	77.3	94.6	111.7	72.0	88.2	104.5	
	67		TC	120.0	120.0	120.0	112.7	112.7	114.8	105.6	105.6	111.2	98.4	98.4	107.4	90.8	90.8	103.5	
			SHC	75.0	96.7	118.5	71.4	93.1	114.8	67.9	89.5	111.2	64.3	85.8	107.4	60.5	82.0	103.5	
	72	TC	132.6	132.6	132.6	124.6	124.6	124.6	116.8	116.8	116.8	108.9	108.9	108.9	100.6	100.6	100.6		
		SHC	54.0	75.9	97.7	50.5	72.2	94.1	47.0	68.7	90.5	43.5	65.2	86.9	39.9	61.5	83.2		
	76	TC	-	143.2	143.2	-	134.6	134.6	-	126.2	126.2	-	117.7	117.7	-	109.0	109.0		
		SHC	-	58.9	81.0	-	55.3	77.3	-	51.8	73.6	-	48.2	70.0	-	44.6	66.2		
	4850 Cfm	EAT (wb)	58	TC	116.1	116.1	131.3	110.0	110.0	124.6	103.9	103.9	117.9	97.7	97.7	111.0	91.1	91.1	103.6
				SHC	100.9	116.1	131.3	95.5	110.0	124.6	90.0	103.9	117.9	84.4	97.7	111.0	78.6	91.1	103.6
62			TC	116.2	116.2	136.5	110.1	110.1	129.6	104.0	104.0	122.7	97.8	97.8	115.5	91.2	91.2	107.9	
			SHC	95.9	116.2	136.5	90.7	110.1	129.6	85.4	104.0	122.7	80.0	97.8	115.5	74.4	91.2	107.9	
67			TC	122.0	122.0	127.4	114.6	114.6	123.6	107.3	107.3	119.8	99.9	99.9	115.9	92.3	92.3	111.6	
			SHC	79.1	103.3	127.4	75.5	99.5	123.6	71.9	95.8	119.8	68.2	92.0	115.9	64.4	87.9	111.6	
72		TC	134.6	134.6	134.6	126.4	126.4	126.4	118.3	118.3	118.3	110.3	110.3	110.3	101.8	101.8	101.8		
		SHC	55.8	80.0	104.2	52.2	76.3	100.5	48.7	72.7	96.9	45.0	69.2	93.3	41.4	65.4	89.5		
76		TC	-	145.2	145.2	-	136.3	136.3	-	127.7	127.7	-	119.0	119.0	-	110.1	110.1		
		SHC	-	61.1	85.5	-	57.4	81.7	-	53.8	78.0	-	50.2	74.3	-	46.5	70.4		
5400 Cfm		EAT (wb)	58	TC	119.6	119.6	135.2	113.2	113.2	128.2	107.0	107.0	121.2	100.4	100.4	114.1	93.6	93.6	106.5
				SHC	103.9	119.6	135.2	98.3	113.2	128.2	92.6	107.0	121.2	86.9	100.4	114.1	80.7	93.6	106.5
	62		TC	119.7	119.7	140.6	113.3	113.3	133.3	107.1	107.1	126.1	100.5	100.5	118.7	93.7	93.7	110.9	
			SHC	98.9	119.7	140.6	93.4	113.3	133.3	87.9	107.1	126.1	82.4	100.5	118.7	76.5	93.7	110.9	
	67		TC	123.7	123.7	135.8	116.2	116.2	131.8	108.8	108.8	127.9	101.5	101.5	123.5	94.1	94.1	118.1	
			SHC	83.1	109.5	135.8	79.3	105.6	131.8	75.6	101.8	127.9	71.8	97.7	123.5	67.5	92.7	118.1	
	72	TC	136.0	136.0	136.0	127.7	127.7	127.7	119.5	119.5	119.5	111.3	111.3	111.3	102.8	102.8	102.8		
		SHC	57.4	83.9	110.6	53.7	80.2	106.8	50.2	76.6	103.1	46.6	73.0	99.4	42.9	69.2	95.6		
	76	TC	-	146.6	146.6	-	137.7	137.7	-	128.9	128.9	-	120.0	120.0	-	111.0	111.0		
		SHC	-	63.1	89.8	-	59.4	86.0	-	55.8	82.2	-	52.1	78.3	-	48.4	74.4		

LEGEND:

- - Do not operate
- Cfm - Cubic feet per minute (supply air)
- EAT (db) - Entering Air Temperature (dry bulb)
- EAT (wb) - Entering Air Temperature (wet bulb)
- SHC - Sensible Heat Capacity (1000 Btuh) Gross
- TC - Total Capacity (1000 Btuh) Gross

Table 21 – COOLING CAPACITIES - THIRD STAGE, FULL LOAD

17.5 TONS

20 SIZE				AMBIENT TEMPERATURE															
				85°F			95°F			105°F			115°F			125°F			
				EAT (db)			EAT (db)			EAT (db)			EAT (db)			EAT (db)			
				75	80	85	75	80	85	75	80	85	75	80	85	75	80	85	
5250 Cfm	EAT (wb)	58	TC	177.4	177.4	201.2	168.6	168.6	191.6	159.3	159.3	181.4	149.7	149.7	170.8	139.3	139.3	159.4	
			SHC	153.6	177.4	201.2	145.6	168.6	191.6	137.2	159.3	181.4	128.5	149.7	170.8	119.1	139.3	159.4	
		62	TC	184.4	184.4	192.2	173.9	173.9	185.7	163.0	163.0	179.1	151.7	151.7	172.2	140.0	140.0	164.5	
			SHC	138.4	165.3	192.2	132.0	158.9	185.7	125.6	152.4	179.1	118.9	145.5	172.2	111.7	138.1	164.5	
		67	TC	202.7	202.7	202.7	191.4	191.4	191.4	179.6	179.6	179.6	167.2	167.2	167.2	154.2	154.2	154.2	
			SHC	112.7	139.7	166.8	106.5	133.6	160.6	100.2	127.2	154.2	93.6	120.6	147.6	87.0	113.9	140.9	
	72	TC	223.1	223.1	223.1	211.2	211.2	211.2	198.6	198.6	198.6	185.4	185.4	185.4	171.8	171.8	171.8		
		SHC	86.6	113.9	141.1	80.5	107.7	135.0	74.3	101.5	128.7	67.9	95.1	122.2	61.3	88.4	115.5		
	76	TC	-	240.5	240.5	-	228.1	228.1	-	215.0	215.0	-	200.9	200.9	-	186.7	186.7		
		SHC	-	92.8	121.0	-	86.9	115.0	-	80.7	108.7	-	74.3	102.1	-	67.8	95.6		
	6150 Cfm	EAT (wb)	58	TC	187.8	187.8	212.8	178.4	178.4	202.6	168.6	168.6	191.8	158.2	158.2	180.5	147.4	147.4	168.5
				SHC	162.7	187.8	212.8	154.2	178.4	202.6	145.4	168.6	191.8	136.1	158.2	180.5	126.4	147.4	168.5
62			TC	190.8	190.8	211.8	180.2	180.2	205.0	169.3	169.3	197.5	158.5	158.5	188.2	147.6	147.6	175.7	
			SHC	150.1	181.0	211.8	143.6	174.3	205.0	136.7	167.1	197.5	128.9	158.5	188.2	119.4	147.6	175.7	
67			TC	208.3	208.3	208.3	196.5	196.5	196.5	184.3	184.3	184.3	171.5	171.5	171.5	158.2	158.2	158.2	
			SHC	120.3	151.5	182.7	114.1	145.3	176.5	107.6	138.8	170.0	101.0	132.1	163.3	94.2	125.3	156.4	
72		TC	228.8	228.8	228.8	216.5	216.5	216.5	203.3	203.3	203.3	189.8	189.8	189.8	175.8	175.8	175.8		
		SHC	90.1	121.5	152.9	83.9	115.2	146.6	77.5	108.8	140.2	71.1	102.4	133.6	64.4	95.6	126.8		
76		TC	-	246.4	246.4	-	233.5	233.5	-	220.0	220.0	-	205.3	205.3	-	190.6	190.6		
		SHC	-	97.1	129.4	-	91.1	123.1	-	84.8	116.8	-	78.3	110.1	-	71.7	103.4		
7000 Cfm		EAT (wb)	58	TC	195.8	195.8	221.7	186.0	186.0	211.0	175.7	175.7	199.7	164.9	164.9	187.8	153.6	153.6	175.3
				SHC	169.7	195.8	221.7	161.0	186.0	211.0	151.7	175.7	199.7	142.0	164.9	187.8	131.7	153.6	175.3
	62		TC	196.4	196.4	228.2	186.1	186.1	219.6	175.9	175.9	208.0	165.1	165.1	195.7	153.8	153.8	182.8	
			SHC	160.0	194.1	228.2	152.7	186.1	219.6	143.8	175.9	208.0	134.5	165.1	195.7	124.6	153.8	182.8	
	67		TC	212.4	212.4	212.4	200.4	200.4	200.4	187.9	187.9	187.9	174.8	174.8	177.5	161.2	161.2	170.3	
			SHC	127.1	162.1	197.2	120.8	155.8	190.8	114.3	149.3	184.3	107.5	142.4	177.5	100.7	135.5	170.3	
	72	TC	233.0	233.0	233.0	220.4	220.4	220.4	206.8	206.8	206.8	193.0	193.0	193.0	178.6	178.6	178.6		
		SHC	93.0	128.2	163.4	86.9	122.0	157.1	80.3	115.4	150.5	73.8	108.8	143.8	67.2	102.1	137.1		
	76	TC	-	250.8	250.8	-	237.4	237.4	-	223.2	223.2	-	208.7	208.7	-	193.5	193.5		
		SHC	-	100.8	136.8	-	94.7	130.6	-	88.2	124.0	-	81.8	117.4	-	75.2	110.6		
	7900 Cfm	EAT (wb)	58	TC	202.8	202.8	229.6	192.7	192.7	218.4	181.9	181.9	206.7	170.7	170.7	194.3	158.9	158.9	181.4
				SHC	176.0	202.8	229.6	166.8	192.7	218.4	157.2	181.9	206.7	147.1	170.7	194.3	136.5	158.9	181.4
62			TC	203.1	203.1	238.9	192.9	192.9	227.3	182.1	182.1	215.2	170.8	170.8	202.4	159.0	159.0	189.0	
			SHC	167.2	203.1	238.9	158.3	192.9	227.3	149.1	182.1	215.2	139.3	170.8	202.4	129.1	159.0	189.0	
67			TC	215.9	215.9	215.9	203.7	203.7	205.4	190.9	190.9	198.7	177.6	177.6	191.6	163.9	163.9	184.2	
			SHC	134.0	173.0	212.0	127.6	166.5	205.4	121.0	159.8	198.7	114.2	152.9	191.6	107.2	145.7	184.2	
72		TC	236.6	236.6	236.6	223.7	223.7	223.7	209.7	209.7	209.7	195.6	195.6	195.6	181.0	181.0	181.0		
		SHC	95.9	135.0	174.1	89.7	128.7	167.8	83.1	122.1	161.1	76.5	115.4	154.3	69.8	108.6	147.4		
76		TC	-	254.1	254.1	-	240.5	240.5	-	226.3	226.3	-	211.5	211.5	-	196.0	196.0		
		SHC	-	104.4	144.3	-	98.2	138.0	-	91.8	131.4	-	85.3	124.7	-	78.5	117.7		
8750 Cfm		EAT (wb)	58	TC	208.5	208.5	236.0	197.9	197.9	224.3	187.0	187.0	212.3	175.3	175.3	199.4	163.2	163.2	186.1
				SHC	181.1	208.5	236.0	171.5	197.9	224.3	161.7	187.0	212.3	151.1	175.3	199.4	140.3	163.2	186.1
	62		TC	208.7	208.7	245.4	198.1	198.1	233.4	187.1	187.1	220.9	175.4	175.4	207.7	163.3	163.3	193.9	
			SHC	172.0	208.7	245.4	162.8	198.1	233.4	153.3	187.1	220.9	143.2	175.4	207.7	132.7	163.3	193.9	
	67		TC	218.7	218.7	225.2	206.3	206.3	218.5	193.4	193.4	211.6	180.0	180.0	204.2	166.1	166.1	196.4	
			SHC	140.1	182.7	225.2	133.7	176.1	218.5	126.9	169.3	211.6	120.0	162.0	204.2	112.8	154.5	196.4	
	72	TC	239.3	239.3	239.3	226.1	226.1	226.1	212.4	212.4	212.4	197.5	197.5	197.5	182.8	182.8	182.8		
		SHC	98.5	141.2	183.9	92.1	134.8	177.5	85.7	128.3	170.8	79.0	121.4	163.9	72.2	114.6	156.9		
	76	TC	-	256.9	256.9	-	243.1	243.1	-	228.5	228.5	-	213.5	213.5	-	197.8	197.8		
		SHC	-	107.7	151.1	-	101.5	144.7	-	95.0	138.1	-	88.3	131.2	-	81.6	124.1		

LEGEND:

- - Do not operate
- Cfm - Cubic feet per minute (supply air)
- EAT (db) - Entering Air Temperature (dry bulb)
- EAT (wb) - Entering Air Temperature (wet bulb)
- SHC - Sensible Heat Capacity (1000 Btuh) Gross
- TC - Total Capacity (1000 Btuh) Gross

50LC*A20 REHEAT MODE #1 CAPACITIES (MBTUH), STANDARD UNITS

Reheat-1 (Subcooler Mode)		AIR ENTERING EVAPORATOR - SCFM/BF (80db)								
		5250			7000			8750		
Outdoor Air Temp ° F		Air Entering Evaporator -- Ewb (F)								
		72	67	62	72	67	62	72	67	62
75	TC	234	210	189	246	223	202	254	231	215
	SHC	106	131	157	123	157	189	138	180	215
	kW	11.6	11.2	10.9	11.8	11.4	11.1	11.9	11.5	11.3
85	TC	219	196	176	230	208	189	238	215	200
	SHC	93	119	145	109	143	176	123	165	200
	kW	12.7	12.4	12.1	12.9	12.6	12.3	13.0	12.7	12.5
95	TC	204	182	163	214	193	175	221	199	184
	SHC	79	106	132	94	129	163	108	150	184
	kW	14.0	13.7	13.4	14.2	13.9	13.6	14.3	14.0	13.7
105	TC	188	167	149	197	177	160	204	183	170
	SHC	64	91	120	78	114	149	92	135	170
	kW	15.5	15.1	14.8	15.7	15.3	15.0	15.8	15.4	15.2
115	TC	172	152	135	180	161	145	186	166	154
	SHC	50	78	106	62	99	135	75	120	154
	kW	17.2	16.8	16.5	17.3	17.0	16.7	17.4	17.1	16.9
125	TC	155	137	120	163	144	129	168	148	138
	SHC	35	64	93	47	84	120	59	103	138
	kW	19.0	18.6	18.3	19.2	18.8	18.5	19.3	18.9	18.7

LEGEND AND NOTES

- kW --- Compressor Power Input
- SHC --- Sensible Heat Capacity (1000 Btuh) Gross
- TC --- Total Capacity (1000 Btuh) Gross

50LC*A20 REHEAT MODE #2 CAPACITIES (MBTUH), STANDARD UNITS

Reheat-2 (Hot Gas Reheat Mode)		AIR ENTERING EVAPORATOR - SCFM/BF (80db)								
		5250			7000			8750		
Outdoor Air Temp ° F		Air Entering Evaporator -- Ewb (F)								
		62.5	64	65.3	62.5	64	65.3	62.5	64	65.3
80	TC	77	80	82	80	83	85	81	84	87
	SHC	18	8	-1	33	20	9	49	34	20
	kW	11.8	12.0	12.2	12.0	12.1	12.3	12.1	12.2	12.4
75	TC	82	86	88	86	89	91	88	91	93
	SHC	24	14	5	39	26	15	55	40	26
	kW	11.3	11.5	11.6	11.5	11.6	11.8	11.6	11.7	11.9
70	TC	88	91	94	92	95	98	94	97	100
	SHC	29	19	10	45	32	21	61	46	32
	kW	10.8	11.0	11.1	11.0	11.1	11.3	11.1	11.2	11.4
60	TC	99	103	106	103	107	110	106	109	112
	SHC	40	30	22	56	43	33	72	58	45
	kW	10.0	10.1	10.2	10.1	10.3	10.4	10.2	10.4	10.5
50	TC	111	114	118	115	119	122	118	122	125
	SHC	51	42	33	68	55	45	84	70	57
	kW	9.2	9.3	9.5	9.3	9.5	9.6	9.5	9.6	9.7
40	TC	122	126	129	127	131	134	130	134	137
	SHC	63	53	45	80	68	57	97	83	70
	kW	8.5	8.7	8.8	8.7	8.8	9.0	8.8	9.0	9.1

LEGEND AND NOTES

- kW --- Compressor Power Input
- SHC --- Sensible Heat Capacity (1000 Btuh) Gross
- TC --- Total Capacity (1000 Btuh) Gross

Table 23 – COOLING CAPACITIES - FIRST STAGE, PART LOAD

20 TONS

24 SIZE				AMBIENT TEMPERATURE															
				85°F			95°F			105°F			115°F			125°F			
				EAT (db)			EAT (db)			EAT (db)			EAT (db)			EAT (db)			
				75	80	85	75	80	85	75	80	85	75	80	85	75	80	85	
3150 Cfm	EAT (wb)	58	TC	87.9	87.9	101.5	79.4	79.4	92.4	70.7	70.7	83.3	61.7	61.7	73.7	52.6	52.6	64.0	
			SHC	74.4	87.9	101.5	66.3	79.4	92.4	58.1	70.7	83.3	49.7	61.7	73.7	41.1	52.6	64.0	
		62	TC	91.3	91.3	101.0	81.4	81.4	93.7	71.6	71.6	86.2	61.9	61.9	77.9	52.7	52.7	67.9	
			SHC	68.1	84.5	101.0	60.8	77.2	93.7	53.5	69.8	86.2	45.8	61.9	77.9	37.4	52.7	67.9	
		67	TC	104.6	104.6	104.6	94.1	94.1	94.1	83.5	83.5	83.5	72.6	72.6	72.6	61.4	61.4	61.4	
			SHC	54.7	71.4	87.9	47.5	64.2	80.7	40.3	56.9	73.5	33.0	49.6	66.2	25.5	42.2	58.8	
	72	TC	119.6	119.6	119.6	108.6	108.6	108.6	97.4	97.4	97.4	86.0	86.0	86.0	74.1	74.1	74.1		
		SHC	41.1	57.8	74.6	33.9	50.6	67.4	26.7	43.4	60.2	19.4	36.2	52.8	12.1	28.8	45.4		
	76	TC	-	132.6	132.6	-	121.1	121.1	-	109.4	109.4	-	97.4	97.4	-	85.0	85.0		
		SHC	-	46.8	63.7	-	39.6	56.6	-	32.4	49.3	-	25.2	42.0	-	17.7	34.6		
	3650 Cfm	EAT (wb)	58	TC	94.8	94.8	109.0	85.7	85.7	99.5	76.5	76.5	89.7	67.2	67.2	79.8	57.5	57.5	69.4
				SHC	80.4	94.8	109.0	72.0	85.7	99.5	63.4	76.5	89.7	54.7	67.2	79.8	45.6	57.5	69.4
62			TC	95.6	95.6	112.7	85.9	85.9	104.2	76.7	76.7	94.3	67.4	67.4	84.1	57.6	57.6	73.5	
			SHC	75.4	94.1	112.7	67.6	85.9	104.2	59.2	76.7	94.3	50.6	67.4	84.1	41.7	57.6	73.5	
67			TC	108.2	108.2	108.2	97.4	97.4	97.4	86.5	86.5	86.5	75.3	75.3	75.8	63.8	63.8	68.2	
			SHC	59.8	78.9	98.0	52.5	71.6	90.7	45.0	64.2	83.3	37.6	56.6	75.8	30.0	49.1	68.2	
72		TC	123.4	123.4	123.4	112.0	112.0	112.0	100.5	100.5	100.5	88.6	88.6	88.6	76.4	76.4	76.4		
		SHC	43.7	63.0	82.2	36.4	55.6	74.9	29.1	48.3	67.5	21.5	40.8	60.0	14.0	33.2	52.5		
76		TC	-	136.5	136.5	-	124.7	124.7	-	112.6	112.6	-	100.2	100.2	-	87.5	87.5		
		SHC	-	49.9	69.4	-	42.6	62.1	-	35.3	54.7	-	27.9	47.2	-	20.3	39.7		
4200 Cfm		EAT (wb)	58	TC	101.0	101.0	115.9	91.6	91.6	105.9	82.0	82.0	95.7	72.2	72.2	85.3	62.1	62.1	74.5
				SHC	86.1	101.0	115.9	77.2	91.6	105.9	68.3	82.0	95.7	59.2	72.2	85.3	49.7	62.1	74.5
	62		TC	101.2	101.2	121.1	91.7	91.7	110.9	82.2	82.2	100.5	72.3	72.3	89.8	62.2	62.2	78.8	
			SHC	81.2	101.2	121.1	72.5	91.7	110.9	63.9	82.2	100.5	54.9	72.3	89.8	45.6	62.2	78.8	
	67		TC	111.4	111.4	111.4	100.2	100.2	101.0	89.0	89.0	93.4	77.6	77.6	85.8	65.8	65.8	77.9	
			SHC	64.9	86.8	108.5	57.5	79.3	101.0	50.0	71.8	93.4	42.4	64.2	85.8	34.7	56.4	77.9	
	72	TC	126.8	126.8	126.8	115.0	115.0	115.0	103.1	103.1	103.1	90.9	90.9	90.9	78.3	78.3	78.3		
		SHC	46.2	68.2	90.1	38.8	60.7	82.6	31.3	53.2	75.2	23.8	45.6	67.6	16.1	38.0	59.9		
	76	TC	-	139.9	139.9	-	127.7	127.7	-	115.2	115.2	-	102.6	102.6	-	89.4	89.4		
		SHC	-	53.0	75.2	-	45.6	67.8	-	38.1	60.3	-	30.6	52.7	-	22.9	44.9		
	4700 Cfm	EAT (wb)	58	TC	105.9	105.9	121.3	96.1	96.1	110.9	86.2	86.2	100.3	76.1	76.1	89.5	65.6	65.6	78.3
				SHC	90.5	105.9	121.3	81.3	96.1	110.9	72.1	86.2	100.3	62.6	76.1	89.5	52.8	65.6	78.3
62			TC	106.0	106.0	126.7	96.2	96.2	116.0	86.4	86.4	105.2	76.1	76.1	94.2	65.7	65.7	82.8	
			SHC	85.4	106.0	126.7	76.4	96.2	116.0	67.5	86.4	105.2	58.2	76.1	94.2	48.7	65.7	82.8	
67			TC	113.8	113.8	117.7	102.5	102.5	110.0	91.1	91.1	102.3	79.4	79.4	94.4	67.5	67.5	86.3	
			SHC	69.4	93.6	117.7	61.8	85.9	110.0	54.2	78.3	102.3	46.5	70.5	94.4	38.7	62.5	86.3	
72		TC	129.0	129.0	129.0	117.0	117.0	117.0	104.9	104.9	104.9	92.4	92.4	92.4	79.7	79.7	79.7		
		SHC	48.4	72.6	97.0	40.9	65.1	89.4	33.2	57.5	81.8	25.6	49.8	74.1	17.8	42.1	66.4		
76		TC	-	142.4	142.4	-	129.9	129.9	-	117.2	117.2	-	104.2	104.2	-	90.9	90.9		
		SHC	-	55.6	80.1	-	48.1	72.6	-	40.6	65.0	-	32.9	57.3	-	25.2	49.5		
5250 Cfm		EAT (wb)	58	TC	110.5	110.5	126.3	100.3	100.3	115.5	90.2	90.2	104.7	79.7	79.7	93.5	68.9	68.9	82.0
				SHC	94.6	110.5	126.3	85.1	100.3	115.5	75.7	90.2	104.7	65.9	79.7	93.5	55.9	68.9	82.0
	62		TC	110.6	110.6	131.8	100.5	100.5	120.8	90.3	90.3	109.7	79.9	79.9	98.3	69.0	69.0	86.5	
			SHC	89.4	110.6	131.8	80.1	100.5	120.8	70.9	90.3	109.7	61.3	79.9	98.3	51.6	69.0	86.5	
	67		TC	115.9	115.9	127.3	104.5	104.5	119.4	92.9	92.9	111.4	81.2	81.2	103.2	69.7	69.7	93.6	
			SHC	74.1	100.7	127.3	66.4	92.9	119.4	58.7	85.0	111.4	50.7	76.9	103.2	42.4	68.0	93.6	
	72	TC	131.0	131.0	131.0	118.9	118.9	118.9	106.5	106.5	106.5	93.9	93.9	93.9	80.8	80.8	80.8		
		SHC	50.5	77.3	104.2	42.9	69.7	96.5	35.2	62.1	88.9	27.5	54.3	81.1	19.7	46.5	73.2		
	76	TC	-	144.4	144.4	-	131.7	131.7	-	118.9	118.9	-	105.7	105.7	-	92.1	92.1		
		SHC	-	58.2	85.3	-	50.7	77.7	-	43.0	70.1	-	35.3	62.3	-	27.5	54.5		

LEGEND:

- - Do not operate
- Cfm - Cubic feet per minute (supply air)
- EAT (db) - Entering Air Temperature (dry bulb)
- EAT (wb) - Entering Air Temperature (wet bulb)
- SHC - Sensible Heat Capacity (1000 Btuh) Gross
- TC - Total Capacity (1000 Btuh) Gross

Table 24 – COOLING CAPACITIES - SECOND STAGE, PART LOAD

20 TONS

24 SIZE			AMBIENT TEMPERATURE																
			85°F			95°F			105°F			115°F			125°F				
			EAT (db)			EAT (db)			EAT (db)			EAT (db)			EAT (db)				
			75	80	85	75	80	85	75	80	85	75	80	85	75	80	85		
3900 Cfm	EAT (wb)	58	TC	128.8	128.8	146.4	121.7	121.7	138.6	114.1	114.1	130.4	105.8	105.8	121.3	96.9	96.9	111.5	
			SHC	111.2	128.8	146.4	104.7	121.7	138.6	97.8	114.1	130.4	90.3	105.8	121.3	82.2	96.9	111.5	
		62	TC	134.0	134.0	141.8	125.6	125.6	136.5	116.5	116.5	130.7	106.8	106.8	124.5	97.0	97.0	116.6	
			SHC	101.1	121.4	141.8	95.8	116.1	136.5	90.3	110.5	130.7	84.3	104.4	124.5	77.4	97.0	116.6	
		67	TC	148.8	148.8	148.8	139.8	139.8	139.8	130.1	130.1	130.1	119.5	119.5	119.5	108.2	108.2	108.2	
			SHC	82.5	103.0	123.4	77.3	97.8	118.3	71.9	92.3	112.8	66.1	86.6	107.1	60.1	80.5	101.0	
	72	TC	165.6	165.6	165.6	156.1	156.1	156.1	145.9	145.9	145.9	134.6	134.6	134.6	122.7	122.7	122.7		
		SHC	63.5	84.1	104.7	58.4	79.0	99.6	53.0	73.6	94.2	47.4	68.0	88.5	41.4	62.0	82.6		
	76	TC	-	179.7	179.7	-	169.8	169.8	-	159.1	159.1	-	147.5	147.5	-	134.8	134.8		
		SHC	-	68.5	89.5	-	63.6	84.4	-	58.3	79.2	-	52.7	73.6	-	46.9	67.7		
	4500 Cfm	EAT (wb)	58	TC	136.4	136.4	154.8	129.0	129.0	146.7	120.9	120.9	138.0	112.1	112.1	128.4	102.8	102.8	118.1
				SHC	118.0	136.4	154.8	111.2	129.0	146.7	103.8	120.9	138.0	95.9	112.1	128.4	87.5	102.8	118.1
62			TC	138.6	138.6	155.8	130.2	130.2	150.1	121.0	121.0	143.8	112.3	112.3	134.1	103.0	103.0	123.4	
			SHC	109.5	132.7	155.8	104.0	127.0	150.1	98.2	121.0	143.8	90.7	112.3	134.1	82.5	103.0	123.4	
67			TC	153.0	153.0	153.0	143.7	143.7	143.7	133.7	133.7	133.7	122.9	122.9	122.9	111.2	111.2	112.1	
			SHC	88.0	111.4	134.9	82.8	106.3	129.7	77.3	100.7	124.1	71.5	94.9	118.3	65.4	88.7	112.1	
72		TC	169.9	169.9	169.9	160.2	160.2	160.2	149.5	149.5	149.5	138.0	138.0	138.0	125.5	125.5	125.5		
		SHC	66.1	89.7	113.3	60.9	84.5	108.1	55.5	79.1	102.6	49.8	73.3	96.8	43.8	67.4	90.9		
76		TC	-	184.1	184.1	-	173.9	173.9	-	162.8	162.8	-	150.8	150.8	-	137.9	137.9		
		SHC	-	71.9	95.7	-	66.7	90.6	-	61.3	85.2	-	55.8	79.6	-	49.8	73.6		
5150 Cfm		EAT (wb)	58	TC	143.3	143.3	162.5	135.5	135.5	154.1	127.0	127.0	144.8	118.0	118.0	134.8	108.1	108.1	124.0
				SHC	124.0	143.3	162.5	117.0	135.5	154.1	109.3	127.0	144.8	101.0	118.0	134.8	92.1	108.1	124.0
	62		TC	143.4	143.4	169.2	135.7	135.7	160.5	127.2	127.2	151.0	118.1	118.1	140.7	108.2	108.2	129.5	
			SHC	117.7	143.4	169.2	110.9	135.7	160.5	103.4	127.2	151.0	95.6	118.1	140.7	87.0	108.2	129.5	
	67		TC	156.6	156.6	156.6	147.0	147.0	147.0	136.8	136.8	136.8	125.7	125.7	129.9	113.7	113.7	123.5	
			SHC	93.8	120.3	146.8	88.4	115.0	141.5	82.9	109.4	135.9	77.0	103.4	129.9	70.8	97.2	123.5	
	72	TC	173.6	173.6	173.6	163.4	163.4	163.4	152.5	152.5	152.5	140.6	140.6	140.6	127.8	127.8	127.8		
		SHC	68.6	95.4	122.1	63.5	90.1	116.8	58.0	84.6	111.3	52.2	78.8	105.5	46.1	72.7	99.4		
	76	TC	-	187.8	187.8	-	177.3	177.3	-	165.9	165.9	-	153.7	153.7	-	140.3	140.3		
		SHC	-	75.0	102.1	-	69.8	96.8	-	64.4	91.4	-	58.8	85.7	-	52.7	79.7		
	5800 Cfm	EAT (wb)	58	TC	149.2	149.2	169.1	141.1	141.1	160.2	132.3	132.3	150.6	122.8	122.8	140.2	112.5	112.5	129.0
				SHC	129.2	149.2	169.1	121.9	141.1	160.2	113.9	132.3	150.6	105.3	122.8	140.2	96.1	112.5	129.0
62			TC	149.3	149.3	175.9	141.2	141.2	166.8	132.4	132.4	157.0	122.9	122.9	146.3	112.7	112.7	134.6	
			SHC	122.7	149.3	175.9	115.5	141.2	166.8	107.9	132.4	157.0	99.6	122.9	146.3	90.7	112.7	134.6	
67			TC	159.4	159.4	159.4	149.8	149.8	152.9	139.2	139.2	147.1	127.9	127.9	141.0	115.8	115.8	134.5	
			SHC	99.2	128.7	158.2	93.8	123.3	152.9	88.1	117.6	147.1	82.2	111.6	141.0	75.9	105.2	134.5	
72		TC	176.3	176.3	176.3	165.9	165.9	165.9	154.8	154.8	154.8	142.7	142.7	142.7	129.8	129.8	129.8		
		SHC	71.0	100.7	130.5	65.7	95.5	125.2	60.3	89.9	119.6	54.4	84.0	113.7	48.3	77.9	107.5		
76		TC	-	190.6	190.6	-	179.9	179.9	-	168.3	168.3	-	155.8	155.8	-	142.3	142.3		
		SHC	-	77.9	108.0	-	72.7	102.8	-	67.3	97.3	-	61.6	91.6	-	55.6	85.4		
6450 Cfm		EAT (wb)	58	TC	154.1	154.1	174.6	145.8	145.8	165.6	136.7	136.7	155.6	126.9	126.9	144.9	116.3	116.3	133.2
				SHC	133.7	154.1	174.6	126.1	145.8	165.6	117.9	136.7	155.6	109.0	126.9	144.9	99.5	116.3	133.2
	62		TC	154.3	154.3	181.6	146.0	146.0	172.3	136.9	136.9	162.1	127.0	127.0	151.0	116.5	116.5	139.0	
			SHC	126.9	154.3	181.6	119.5	146.0	172.3	111.6	136.9	162.1	103.2	127.0	151.0	93.9	116.5	139.0	
	67		TC	161.9	161.9	169.3	152.0	152.0	163.7	141.5	141.5	157.9	130.1	130.1	151.4	117.9	117.9	144.4	
			SHC	104.3	136.8	169.3	98.9	131.3	163.7	93.2	125.5	157.9	87.2	119.3	151.4	80.6	112.5	144.4	
	72	TC	178.5	178.5	178.5	168.0	168.0	168.0	156.7	156.7	156.7	144.4	144.4	144.4	131.1	131.1	131.1		
		SHC	73.2	105.9	138.5	67.9	100.5	133.2	62.3	95.0	127.6	56.5	89.1	121.7	50.3	82.9	115.4		
	76	TC	-	192.9	192.9	-	182.0	182.0	-	170.2	170.2	-	157.5	157.5	-	143.8	143.8		
		SHC	-	80.7	113.7	-	75.5	108.5	-	70.0	103.0	-	64.3	97.1	-	58.2	91.1		

LEGEND:

- - Do not operate
- Cfm - Cubic feet per minute (supply air)
- EAT (db) - Entering Air Temperature (dry bulb)
- EAT (wb) - Entering Air Temperature (wet bulb)
- SHC - Sensible Heat Capacity (1000 Btuh) Gross
- TC - Total Capacity (1000 Btuh) Gross

Table 25 – COOLING CAPACITIES - THIRD STAGE, FULL LOAD

20 TONS

24 SIZE			AMBIENT TEMPERATURE																
			85°F			95°F			105°F			115°F			125°F				
			EAT (db)			EAT (db)			EAT (db)			EAT (db)			EAT (db)				
			75	80	85	75	80	85	75	80	85	75	80	85	75	80	85		
6000 Cfm	EAT (wb)	58	TC	217.4	217.4	245.6	208.3	208.3	235.6	198.5	198.5	224.7	188.0	188.0	213.0	176.6	176.6	200.3	
			SHC	189.2	217.4	245.6	181.1	208.3	235.6	172.4	198.5	224.7	163.0	188.0	213.0	152.9	176.6	200.3	
		62	TC	227.3	227.3	230.2	216.2	216.2	224.2	204.4	204.4	217.6	191.7	191.7	210.8	178.2	178.2	203.0	
			SHC	169.0	199.6	230.2	162.9	193.5	224.2	156.6	187.1	217.6	149.9	180.4	210.8	142.6	172.9	203.0	
		67	TC	248.8	248.8	248.8	236.8	236.8	236.8	224.1	224.1	224.1	210.2	210.2	210.2	195.4	195.4	195.4	
			SHC	139.0	169.8	200.7	133.2	164.0	194.7	127.0	157.8	188.6	120.5	151.2	182.0	113.7	144.4	175.1	
	72	TC	273.6	273.6	273.6	260.9	260.9	260.9	247.1	247.1	247.1	232.2	232.2	232.2	216.4	216.4	216.4		
		SHC	108.9	140.0	171.0	103.3	134.3	165.3	97.1	128.1	159.1	90.8	121.7	152.7	84.0	115.0	145.9		
	76	TC	-	294.8	294.8	-	281.4	281.4	-	266.8	266.8	-	251.1	251.1	-	234.3	234.3		
		SHC	-	115.5	147.7	-	110.0	142.2	-	103.9	135.9	-	97.7	129.4	-	91.1	122.7		
	7000 Cfm	EAT (wb)	58	TC	229.4	229.4	259.1	219.7	219.7	248.3	209.2	209.2	236.7	198.0	198.0	224.2	185.9	185.9	210.7
				SHC	199.7	229.4	259.1	191.1	219.7	248.3	181.7	209.2	236.7	171.8	198.0	224.2	161.1	185.9	210.7
62			TC	234.9	234.9	252.1	223.4	223.4	245.7	211.3	211.3	238.8	199.3	199.3	229.8	186.2	186.2	219.4	
			SHC	182.0	217.1	252.1	175.8	210.8	245.7	169.3	204.0	238.8	161.7	195.7	229.8	153.1	186.2	219.4	
67			TC	256.2	256.2	256.2	243.2	243.2	243.2	229.8	229.8	229.8	215.6	215.6	215.6	200.3	200.3	200.3	
			SHC	147.7	183.1	218.5	141.6	177.0	212.3	135.3	170.6	206.0	128.7	164.1	199.4	121.8	157.1	192.4	
72		TC	281.0	281.0	281.0	267.6	267.6	267.6	253.2	253.2	253.2	237.7	237.7	237.7	221.3	221.3	221.3		
		SHC	112.8	148.5	184.2	107.1	142.6	178.2	100.8	136.4	172.0	94.4	129.9	165.4	87.6	123.0	158.5		
76		TC	-	302.4	302.4	-	288.3	288.3	-	273.1	273.1	-	256.7	256.7	-	239.4	239.4		
		SHC	-	120.4	157.2	-	114.7	151.3	-	108.6	145.1	-	102.2	138.5	-	95.5	131.6		
8000 Cfm		EAT (wb)	58	TC	239.2	239.2	270.1	228.9	228.9	258.8	217.9	217.9	246.5	206.2	206.2	233.4	193.5	193.5	219.3
				SHC	208.3	239.2	270.1	199.2	228.9	258.8	189.4	217.9	246.5	179.0	206.2	233.4	167.8	193.5	219.3
	62		TC	241.3	241.3	272.3	229.9	229.9	265.0	218.1	218.1	256.1	206.6	206.6	242.9	193.7	193.7	228.1	
			SHC	194.0	233.1	272.3	187.4	226.2	265.0	180.0	218.1	256.1	170.1	206.5	242.9	159.3	193.7	228.1	
	67		TC	261.6	261.6	261.6	248.2	248.2	248.2	234.5	234.5	234.5	219.8	219.8	219.8	204.0	204.0	208.7	
			SHC	155.7	195.6	235.5	149.5	189.3	229.2	143.1	183.0	222.8	136.5	176.4	216.2	129.4	169.1	208.7	
	72	TC	286.7	286.7	286.7	272.9	272.9	272.9	258.0	258.0	258.0	242.1	242.1	242.1	225.0	225.0	225.0		
		SHC	116.4	156.5	196.7	110.5	150.5	190.7	104.2	144.3	184.4	97.7	137.7	177.6	90.8	130.7	170.6		
	76	TC	-	308.3	308.3	-	293.8	293.8	-	278.1	278.1	-	261.1	261.1	-	243.3	243.3		
		SHC	-	124.9	166.0	-	119.0	160.1	-	112.9	153.8	-	106.4	147.1	-	99.6	140.2		
	9000 Cfm	EAT (wb)	58	TC	247.4	247.4	279.2	236.7	236.7	267.4	225.3	225.3	254.8	213.0	213.0	241.1	199.9	199.9	226.4
				SHC	215.4	247.4	279.2	206.0	236.7	267.4	195.9	225.3	254.8	185.1	213.0	241.1	173.4	199.9	226.4
62			TC	247.7	247.7	290.4	236.9	236.9	278.0	225.5	225.5	264.8	213.2	213.2	250.7	200.1	200.1	235.5	
			SHC	205.0	247.7	290.4	195.9	236.9	278.0	186.2	225.5	264.8	175.8	213.2	250.7	164.7	200.1	235.5	
67			TC	266.1	266.1	266.1	252.2	252.2	252.2	238.3	238.3	239.0	223.3	223.3	232.0	207.2	207.2	224.3	
			SHC	163.4	207.6	251.8	157.1	201.2	245.4	150.6	194.8	239.0	143.9	187.9	232.0	136.7	180.5	224.3	
72		TC	291.1	291.1	291.1	277.0	277.0	277.0	261.8	261.8	261.8	245.4	245.4	245.4	228.1	228.1	228.1		
		SHC	119.6	164.1	208.7	113.7	158.1	202.6	107.3	151.8	196.2	100.7	145.1	189.3	93.8	138.1	182.3		
76		TC	-	313.0	313.0	-	298.1	298.1	-	281.9	281.9	-	264.6	264.6	-	246.3	246.3		
		SHC	-	129.0	174.4	-	123.1	168.5	-	116.9	162.1	-	110.4	155.4	-	103.5	148.4		
10000 Cfm		EAT (wb)	58	TC	254.8	254.8	287.6	243.4	243.4	275.0	231.6	231.6	261.8	218.8	218.8	247.6	205.1	205.1	232.2
				SHC	222.0	254.8	287.6	211.9	243.4	275.0	201.4	231.6	261.8	190.1	218.8	247.6	177.9	205.1	232.2
	62		TC	255.1	255.1	298.9	243.6	243.6	285.8	231.8	231.8	272.1	219.0	219.0	257.4	205.2	205.2	241.5	
			SHC	211.2	255.1	298.9	201.4	243.6	285.8	191.5	231.8	272.1	180.7	219.0	257.4	169.1	205.2	241.5	
	67		TC	269.3	269.3	269.3	255.9	255.9	261.1	241.5	241.5	254.3	226.2	226.2	247.0	210.1	210.1	239.0	
			SHC	170.4	218.9	267.3	164.3	212.7	261.1	157.8	206.0	254.3	150.8	198.9	247.0	143.4	191.2	239.0	
	72	TC	294.7	294.7	294.7	280.4	280.4	280.4	264.8	264.8	264.8	248.0	248.0	248.0	230.4	230.4	230.4		
		SHC	122.7	171.4	220.2	116.7	165.4	214.0	110.4	158.9	207.6	103.6	152.2	200.8	96.7	145.1	193.5		
	76	TC	-	316.8	316.8	-	301.5	301.5	-	285.1	285.1	-	267.4	267.4	-	248.7	248.7		
		SHC	-	133.0	182.6	-	127.0	176.6	-	120.8	170.1	-	114.2	163.4	-	107.3	156.3		

LEGEND:

- - Do not operate
- Cfm - Cubic feet per minute (supply air)
- EAT (db) - Entering Air Temperature (dry bulb)
- EAT (wb) - Entering Air Temperature (wet bulb)
- SHC - Sensible Heat Capacity (1000 Btuh) Gross
- TC - Total Capacity (1000 Btuh) Gross

50LC*A24 REHEAT MODE #1 CAPACITIES (MBTUH), STANDARD UNITS

Reheat-1 (Subcooler Mode)		AIR ENTERING EVAPORATOR - SCFM/BF (80db)								
		6000			8000			10000		
Outdoor Air Temp ° F		Air Entering Evaporator -- Ewb (F)								
		72	67	62	72	67	62	72	67	62
75	TC	274	246	221	292	263	238	281	273	250
	SHC	120	148	176	140	176	213	136	202	244
	kW	13.5	13.2	12.9	13.7	13.4	13.1	13.4	13.5	13.3
85	TC	261	233	208	277	249	225	287	258	237
	SHC	107	136	164	126	163	201	142	188	231
	kW	14.9	14.6	14.3	15.1	14.8	14.5	15.3	14.9	14.7
95	TC	245	219	196	261	232	211	270	243	222
	SHC	93	123	153	111	148	188	127	174	217
	kW	16.5	16.2	15.8	16.8	16.3	16.1	16.9	16.5	16.2
105	TC	230	205	182	244	218	196	253	226	209
	SHC	80	110	141	96	135	175	111	159	197
	kW	18.4	18.0	17.7	18.6	18.2	17.9	18.7	18.3	18.1
115	TC	213	189	168	226	201	181	234	209	191
	SHC	65	97	128	80	121	161	95	143	187
	kW	20.4	20.1	19.7	20.6	20.2	19.9	20.8	20.4	20.1
125	TC	196	173	153	207	183	164	214	190	173
	SHC	50	83	115	64	105	146	77	127	173
	kW	22.7	22.4	22.0	22.9	22.5	22.2	23.0	22.6	22.4

LEGEND AND NOTES

- kW --- Compressor Power Input
- SHC --- Sensible Heat Capacity (1000 Btuh) Gross
- TC --- Total Capacity (1000 Btuh) Gross

50LC*A24 REHEAT MODE #2 CAPACITIES (MBTUH), STANDARD UNITS

Reheat-2 (Hot Gas Reheat Mode)		AIR ENTERING EVAPORATOR - SCFM/BF (80db)								
		6000			8000			10000		
Outdoor Air Temp ° F		Air Entering Evaporator -- Ewb (F)								
		62.5	64	65.3	62.5	64	65.3	62.5	64	65.3
80	TC	89	93	96	92	96	99	94	98	101
	SHC	17	5	-5	32	17	5	48	31	16
	kW	19.6	19.9	20.2	19.9	20.2	20.4	20.0	20.3	20.6
75	TC	96	100	103	100	103	107	102	105	109
	SHC	24	12	2	39	24	12	55	38	23
	kW	18.7	19.0	19.3	19.0	19.3	19.5	19.2	19.5	19.7
70	TC	103	107	110	107	111	114	109	113	116
	SHC	30	18	8	46	31	19	62	45	30
	kW	17.9	18.2	18.4	18.2	18.5	18.7	18.4	18.6	18.9
60	TC	117	121	124	121	125	129	124	128	132
	SHC	43	32	22	59	45	33	76	59	45
	kW	16.4	16.7	16.9	16.7	16.9	17.2	16.9	17.1	17.4
50	TC	131	135	139	136	140	144	139	143	147
	SHC	56	45	35	73	59	47	91	74	59
	kW	15.1	15.3	15.6	15.4	15.6	15.9	15.6	15.8	16.0
40	TC	145	149	153	150	155	159	154	158	162
	SHC	70	59	49	87	74	62	105	89	75
	kW	14.0	14.2	14.4	14.3	14.5	14.7	14.4	14.7	14.9

LEGEND AND NOTES

- kW --- Compressor Power Input
- SHC --- Sensible Heat Capacity (1000 Btuh) Gross
- TC --- Total Capacity (1000 Btuh) Gross

Table 27 – COOLING CAPACITIES - FIRST STAGE, PART LOAD

23 TONS

26 SIZE			AMBIENT TEMPERATURE																
			85°F			95°F			105°F			115°F			125°F				
			EAT (db)			EAT (db)			EAT (db)			EAT (db)			EAT (db)				
			75	80	85	75	80	85	75	80	85	75	80	85	75	80	85		
4050 Cfm	EAT (wb)	58	TC	125.3	125.3	141.0	122.3	122.3	137.4	118.9	118.9	133.4	115.1	115.1	129.0	110.8	110.8	123.9	
			SHC	109.6	125.3	141.0	107.2	122.3	137.4	104.3	118.9	133.4	101.1	115.1	129.0	97.5	110.8	123.9	
		62	TC	126.7	126.7	142.1	122.9	122.9	140.4	119.0	119.0	138.5	115.1	115.1	133.8	110.9	110.9	128.5	
			SHC	102.4	122.3	142.1	101.1	120.7	140.4	99.5	119.0	138.5	96.5	115.1	133.8	93.2	110.9	128.5	
		67	TC	137.1	137.1	137.1	132.6	132.6	132.6	127.7	127.7	127.7	122.4	122.4	122.4	116.5	116.5	117.5	
			SHC	82.5	102.7	122.9	81.4	101.6	121.8	80.1	100.4	120.6	78.8	99.0	119.1	77.2	97.3	117.5	
	72	TC	149.9	149.9	149.9	144.8	144.8	144.8	139.3	139.3	139.3	133.4	133.4	133.4	126.8	126.8	126.8		
		SHC	61.8	82.2	102.5	60.8	81.1	101.4	59.7	80.0	100.2	58.3	78.6	98.8	56.7	77.0	97.2		
	76	TC	-	160.7	160.7	-	155.1	155.1	-	149.2	149.2	-	142.7	142.7	-	135.6	135.6		
		SHC	-	65.5	86.4	-	64.4	85.2	-	63.3	84.0	-	62.0	82.6	-	60.5	81.0		
	4750 Cfm	EAT (wb)	58	TC	130.8	130.8	147.2	127.4	127.4	143.2	123.7	123.7	138.9	119.5	119.5	134.1	114.9	114.9	128.6
				SHC	114.4	130.8	147.2	111.5	127.4	143.2	108.5	123.7	138.9	105.0	119.5	134.1	101.0	114.9	128.6
62			TC	130.9	130.9	152.9	127.5	127.5	148.7	123.8	123.8	144.1	119.6	119.6	139.0	114.9	114.9	133.3	
			SHC	108.9	130.9	152.9	106.4	127.5	148.7	103.4	123.8	144.1	100.2	119.6	139.0	96.5	114.9	133.3	
67			TC	139.8	139.8	139.8	135.1	135.1	135.1	130.1	130.1	131.2	124.5	124.5	129.7	118.5	118.5	127.8	
			SHC	87.4	110.6	133.8	86.2	109.4	132.6	84.9	108.1	131.2	83.5	106.6	129.7	81.8	104.8	127.8	
72		TC	152.8	152.8	152.8	147.4	147.4	147.4	141.8	141.8	141.8	135.5	135.5	135.5	128.7	128.7	128.7		
		SHC	63.8	87.1	110.4	62.7	85.9	109.2	61.4	84.7	107.9	60.1	83.3	106.5	58.5	81.6	104.8		
76		TC	-	163.7	163.7	-	158.0	158.0	-	151.7	151.7	-	144.9	144.9	-	137.5	137.5		
		SHC	-	68.1	91.8	-	67.0	90.7	-	65.7	89.4	-	64.4	87.9	-	62.8	86.2		
5400 Cfm		EAT (wb)	58	TC	135.0	135.0	152.1	131.4	131.4	147.8	127.4	127.4	143.1	122.9	122.9	138.0	118.0	118.0	132.1
				SHC	118.1	135.0	152.1	115.1	131.4	147.8	111.7	127.4	143.1	107.9	122.9	138.0	103.7	118.0	132.1
	62		TC	135.1	135.1	157.9	131.5	131.5	153.4	127.5	127.5	148.5	123.0	123.0	143.0	118.0	118.0	137.0	
			SHC	112.4	135.1	157.9	109.6	131.5	153.4	106.5	127.5	148.5	103.0	123.0	143.0	99.1	118.0	137.0	
	67		TC	141.9	141.9	143.3	137.0	137.0	142.0	131.8	131.8	140.6	126.2	126.2	138.8	120.0	120.0	136.7	
			SHC	91.7	117.5	143.3	90.4	116.2	142.0	89.1	114.9	140.6	87.7	113.2	138.8	85.8	111.2	136.7	
	72	TC	154.8	154.8	154.8	149.3	149.3	149.3	143.4	143.4	143.4	137.0	137.0	137.0	130.0	130.0	130.0		
		SHC	65.4	91.4	117.3	64.3	90.2	116.0	63.0	88.9	114.8	61.6	87.5	113.2	60.1	85.8	111.5		
	76	TC	-	165.9	165.9	-	159.9	159.9	-	153.4	153.4	-	146.4	146.4	-	138.8	138.8		
		SHC	-	70.2	96.6	-	69.1	95.4	-	67.9	94.1	-	66.4	92.5	-	64.8	90.8		
	6100 Cfm	EAT (wb)	58	TC	138.9	138.9	156.5	135.0	135.0	151.9	130.7	130.7	146.9	126.1	126.1	141.5	120.7	120.7	135.3
				SHC	121.4	138.9	156.5	118.2	135.0	151.9	114.6	130.7	146.9	110.7	126.1	141.5	106.2	120.7	135.3
62			TC	139.0	139.0	162.4	135.1	135.1	157.7	130.8	130.8	152.5	126.1	126.1	146.7	120.8	120.8	140.3	
			SHC	115.5	139.0	162.4	112.6	135.1	157.7	109.2	130.8	152.5	105.5	126.1	146.7	101.3	120.8	140.3	
67			TC	143.7	143.7	153.1	138.7	138.7	151.6	133.5	133.5	150.1	127.7	127.7	148.0	121.6	121.6	145.4	
			SHC	95.9	124.5	153.1	94.8	123.2	151.6	93.4	121.7	150.1	91.7	119.8	148.0	89.7	117.6	145.4	
72		TC	156.6	156.6	156.6	150.8	150.8	150.8	144.8	144.8	144.8	138.3	138.3	138.3	131.0	131.0	131.0		
		SHC	67.1	95.6	124.3	65.9	94.5	123.1	64.6	93.2	121.7	63.2	91.7	120.1	61.6	90.0	118.4		
76		TC	-	167.8	167.8	-	161.6	161.6	-	154.9	154.9	-	147.8	147.8	-	139.9	139.9		
		SHC	-	72.4	101.5	-	71.3	100.2	-	70.0	98.9	-	68.5	97.3	-	66.9	95.4		
6750 Cfm		EAT (wb)	58	TC	142.0	142.0	159.9	137.9	137.9	155.1	133.4	133.4	150.0	128.4	128.4	144.2	122.9	122.9	137.8
				SHC	124.0	142.0	159.9	120.6	137.9	155.1	116.9	133.4	150.0	112.7	128.4	144.2	108.0	122.9	137.8
	62		TC	142.1	142.1	166.0	138.0	138.0	161.0	133.5	133.5	155.6	128.5	128.5	149.6	122.9	122.9	142.8	
			SHC	118.1	142.1	166.0	114.9	138.0	161.0	111.3	133.5	155.6	107.4	128.5	149.6	103.1	122.9	142.8	
	67		TC	145.2	145.2	161.6	140.2	140.2	160.0	134.8	134.8	158.0	129.2	129.2	155.5	123.1	123.1	151.9	
			SHC	99.8	130.7	161.6	98.5	129.3	160.0	97.0	127.5	158.0	95.2	125.4	155.5	92.7	122.4	151.9	
	72	TC	157.9	157.9	157.9	152.1	152.1	152.1	145.9	145.9	145.9	139.1	139.1	139.1	131.8	131.8	131.8		
		SHC	68.5	99.6	130.7	67.4	98.4	129.4	66.1	97.0	127.9	64.6	95.5	126.4	63.0	93.8	124.5		
	76	TC	-	169.2	169.2	-	162.7	162.7	-	156.0	156.0	-	148.7	148.7	-	140.7	140.7		
		SHC	-	74.4	105.9	-	73.2	104.6	-	71.9	103.2	-	70.4	101.5	-	68.7	99.5		

LEGEND:

- - Do not operate
- Cfm - Cubic feet per minute (supply air)
- EAT (db) - Entering Air Temperature (dry bulb)
- EAT (wb) - Entering Air Temperature (wet bulb)
- SHC - Sensible Heat Capacity (1000 Btuh) Gross
- TC - Total Capacity (1000 Btuh) Gross

Table 28 – COOLING CAPACITIES - SECOND STAGE, PART LOAD

23 TONS

26 SIZE			AMBIENT TEMPERATURE																
			85°F			95°F			105°F			115°F			125°F				
			EAT (db)			EAT (db)			EAT (db)			EAT (db)			EAT (db)				
			75	80	85	75	80	85	75	80	85	75	80	85	75	80	85		
4850 Cfm	EAT (wb)	58	TC	157.5	157.5	178.5	149.6	149.6	169.9	141.2	141.2	160.8	132.3	132.3	151.0	122.7	122.7	140.4	
			SHC	136.4	157.5	178.5	129.3	149.6	169.9	121.7	141.2	160.8	113.7	132.3	151.0	105.0	122.7	140.4	
		62	TC	164.0	164.0	170.5	154.5	154.5	164.7	144.7	144.7	158.5	134.4	134.4	151.9	123.3	123.3	144.5	
			SHC	123.0	146.7	170.5	117.3	141.0	164.7	111.3	134.9	158.5	105.0	128.4	151.9	98.3	121.4	144.5	
		67	TC	181.1	181.1	181.1	170.7	170.7	170.7	159.8	159.8	159.8	148.2	148.2	148.2	135.8	135.8	135.8	
			SHC	100.8	124.6	148.5	95.1	119.0	142.8	89.2	113.1	136.9	83.1	107.0	130.7	76.7	100.5	124.3	
	72	TC	200.2	200.2	200.2	189.0	189.0	189.0	177.2	177.2	177.2	164.8	164.8	164.8	151.4	151.4	151.4		
		SHC	78.1	102.2	126.3	72.4	96.5	120.5	66.5	90.6	114.7	60.5	84.5	108.5	54.2	78.1	102.1		
	76	TC	-	216.2	216.2	-	204.3	204.3	-	191.9	191.9	-	178.6	178.6	-	164.6	164.6		
		SHC	-	83.8	109.0	-	78.1	103.2	-	72.3	97.2	-	66.2	91.0	-	60.0	84.5		
	5700 Cfm	EAT (wb)	58	TC	167.0	167.0	189.2	158.5	158.5	179.9	149.7	149.7	170.1	140.1	140.1	159.6	129.8	129.8	148.3
				SHC	144.8	167.0	189.2	137.2	158.5	179.9	129.1	149.7	170.1	120.5	140.1	159.6	111.2	129.8	148.3
62			TC	170.0	170.0	187.4	160.4	160.4	181.1	150.4	150.4	174.2	140.2	140.2	166.3	130.0	130.0	154.6	
			SHC	133.3	160.3	187.4	127.2	154.1	181.1	121.0	147.6	174.2	114.1	140.2	166.3	105.2	130.0	154.6	
67			TC	186.5	186.5	186.5	175.4	175.4	175.4	164.1	164.1	164.1	152.1	152.1	152.1	139.2	139.2	139.2	
			SHC	107.5	134.9	162.3	101.7	129.0	156.4	95.6	123.0	150.4	89.5	116.8	144.2	83.0	110.3	137.6	
72		TC	205.5	205.5	205.5	193.9	193.9	193.9	181.6	181.6	181.6	168.7	168.7	168.7	154.9	154.9	154.9		
		SHC	81.2	108.8	136.5	75.5	103.1	130.7	69.5	97.0	124.6	63.4	90.9	118.4	56.9	84.4	111.8		
76		TC	-	221.7	221.7	-	209.3	209.3	-	196.5	196.5	-	182.6	182.6	-	168.1	168.1		
		SHC	-	87.7	116.2	-	81.9	110.3	-	76.0	104.2	-	69.8	98.0	-	63.5	91.5		
6500 Cfm		EAT (wb)	58	TC	174.4	174.4	197.4	165.5	165.5	187.7	156.0	156.0	177.3	146.0	146.0	166.2	135.1	135.1	154.3
				SHC	151.3	174.4	197.4	143.3	165.5	187.7	134.7	156.0	177.3	125.7	146.0	166.2	116.0	135.1	154.3
	62		TC	175.2	175.2	201.4	165.5	165.5	195.1	156.2	156.2	184.6	146.1	146.1	173.2	135.3	135.3	160.9	
			SHC	142.0	171.7	201.4	135.9	165.5	195.1	127.8	156.2	184.6	119.0	146.1	173.2	109.7	135.3	160.9	
	67		TC	190.1	190.1	190.1	178.8	178.8	178.8	167.2	167.2	167.2	154.9	154.9	156.0	141.9	141.9	149.4	
			SHC	113.3	143.9	174.4	107.3	137.9	168.5	101.3	131.8	162.4	95.1	125.6	156.0	88.5	119.0	149.4	
	72	TC	209.4	209.4	209.4	197.4	197.4	197.4	184.9	184.9	184.9	171.5	171.5	171.5	157.4	157.4	157.4		
		SHC	83.9	114.7	145.4	78.0	108.7	139.4	72.0	102.7	133.4	65.8	96.4	127.0	59.3	89.9	120.4		
	76	TC	-	225.7	225.7	-	213.0	213.0	-	199.8	199.8	-	185.4	185.4	-	170.6	170.6		
		SHC	-	90.9	122.6	-	85.1	116.6	-	79.1	110.6	-	72.8	104.1	-	66.4	97.6		
	7300 Cfm	EAT (wb)	58	TC	180.5	180.5	204.3	171.0	171.0	193.8	161.2	161.2	183.0	150.7	150.7	171.6	139.5	139.5	159.2
				SHC	156.8	180.5	204.3	148.2	171.0	193.8	139.3	161.2	183.0	130.0	150.7	171.6	119.9	139.5	159.2
62			TC	180.7	180.7	212.4	171.2	171.2	201.6	161.4	161.4	190.5	150.9	150.9	178.7	139.6	139.6	165.8	
			SHC	148.9	180.7	212.4	140.7	171.2	201.6	132.2	161.4	190.5	123.1	150.9	178.7	113.4	139.6	165.8	
67			TC	193.2	193.2	193.2	181.7	181.7	181.7	170.0	170.0	173.7	157.4	157.4	167.4	144.1	144.1	160.4	
			SHC	119.0	152.6	186.2	112.9	146.5	180.2	106.8	140.2	173.7	100.4	134.0	167.4	93.7	127.0	160.4	
72		TC	212.6	212.6	212.6	200.3	200.3	200.3	187.4	187.4	187.4	173.8	173.8	173.8	159.4	159.4	159.4		
		SHC	86.3	120.2	154.1	80.4	114.3	148.0	74.3	108.1	141.9	68.1	101.8	135.4	61.5	95.2	128.8		
76		TC	-	228.9	228.9	-	216.1	216.1	-	202.5	202.5	-	187.8	187.8	-	172.7	172.7		
		SHC	-	94.0	128.7	-	88.1	122.8	-	82.1	116.6	-	75.8	110.1	-	69.3	103.5		
8100 Cfm		EAT (wb)	58	TC	185.6	185.6	209.9	175.8	175.8	199.2	165.7	165.7	188.0	154.8	154.8	176.1	143.2	143.2	163.3
				SHC	161.3	185.6	209.9	152.4	175.8	199.2	143.3	165.7	188.0	133.6	154.8	176.1	123.1	143.2	163.3
	62		TC	185.8	185.8	218.3	176.0	176.0	207.2	165.8	165.8	195.7	154.9	154.9	183.4	143.3	143.3	170.1	
			SHC	153.3	185.8	218.3	144.7	176.0	207.2	135.9	165.8	195.7	126.6	154.9	183.4	116.5	143.3	170.1	
	67		TC	195.9	195.9	197.6	184.3	184.3	191.3	172.2	172.2	185.0	159.5	159.5	178.1	146.2	146.2	170.6	
			SHC	124.2	160.9	197.6	118.1	154.7	191.3	111.9	148.5	185.0	105.4	141.8	178.1	98.6	134.6	170.6	
	72	TC	215.2	215.2	215.2	202.6	202.6	202.6	189.5	189.5	189.5	175.7	175.7	175.7	161.0	161.0	161.0		
		SHC	88.6	125.5	162.3	82.7	119.4	156.2	76.5	113.3	150.1	70.2	106.9	143.5	63.6	100.2	136.8		
	76	TC	-	231.7	231.7	-	218.5	218.5	-	204.7	204.7	-	189.7	189.7	-	174.4	174.4		
		SHC	-	96.9	134.6	-	91.0	128.6	-	84.9	122.4	-	78.5	115.8	-	72.0	109.2		

LEGEND:

- - Do not operate
- Cfm - Cubic feet per minute (supply air)
- EAT (db) - Entering Air Temperature (dry bulb)
- EAT (wb) - Entering Air Temperature (wet bulb)
- SHC - Sensible Heat Capacity (1000 Btuh) Gross
- TC - Total Capacity (1000 Btuh) Gross

Table 29 – COOLING CAPACITIES - THIRD STAGE, FULL LOAD

23 TONS

26 SIZE			AMBIENT TEMPERATURE																
			85°F			95°F			105°F			115°F			125°F				
			EAT (db)			EAT (db)			EAT (db)			EAT (db)			EAT (db)				
			75	80	85	75	80	85	75	80	85	75	80	85	75	80	85		
6750 Cfm	EAT (wb)	58	TC	236.0	236.0	267.5	224.8	224.8	255.5	212.8	212.8	242.3	200.0	200.0	228.2	186.1	186.1	212.9	
			SHC	204.3	236.0	267.5	194.3	224.8	255.5	183.4	212.8	242.3	171.8	200.0	228.2	159.3	186.1	212.9	
		62	TC	249.9	249.9	249.9	236.2	236.2	236.6	222.1	222.1	228.0	206.8	206.8	218.7	190.5	190.5	208.8	
			SHC	180.1	212.6	245.0	171.7	204.2	236.6	163.1	195.6	228.0	154.1	186.4	218.7	144.5	176.7	208.8	
		67	TC	275.4	275.4	275.4	260.8	260.8	260.8	245.4	245.4	245.4	228.7	228.7	228.7	210.9	210.9	210.9	
			SHC	149.4	181.9	214.6	141.1	173.6	206.3	132.5	165.1	197.6	123.5	156.1	188.6	114.1	146.6	179.1	
	72	TC	304.3	304.3	304.3	288.6	288.6	288.6	271.7	271.7	271.7	254.1	254.1	254.1	234.9	234.9	234.9		
		SHC	118.3	151.4	184.6	110.1	143.2	176.3	101.5	134.6	167.6	92.7	125.7	158.5	83.5	116.3	149.2		
	76	TC	-	328.7	328.7	-	312.0	312.0	-	294.3	294.3	-	275.2	275.2	-	255.1	255.1		
		SHC	-	126.5	162.7	-	118.4	154.2	-	109.8	145.3	-	100.9	135.9	-	91.7	126.4		
	7900 Cfm	EAT (wb)	58	TC	249.9	249.9	283.1	237.8	237.8	269.9	225.1	225.1	256.0	211.5	211.5	241.0	196.9	196.9	224.9
				SHC	216.6	249.9	283.1	205.7	237.8	269.9	194.3	225.1	256.0	181.9	211.5	241.0	168.8	196.9	224.9
62			TC	258.9	258.9	268.2	244.8	244.8	259.5	230.2	230.2	250.4	214.6	214.6	240.4	198.1	198.1	229.5	
			SHC	194.1	231.2	268.2	185.6	222.6	259.5	176.8	213.5	250.4	167.3	203.9	240.4	157.2	193.3	229.5	
67			TC	284.4	284.4	284.4	269.0	269.0	269.0	252.8	252.8	252.8	235.5	235.5	235.5	216.8	216.8	216.8	
			SHC	158.7	196.1	233.3	150.2	187.5	224.7	141.6	178.7	216.0	132.4	169.6	206.7	122.8	159.9	197.0	
72		TC	313.6	313.6	313.6	297.1	297.1	297.1	279.6	279.6	279.6	261.0	261.0	261.0	241.1	241.1	241.1		
		SHC	122.9	160.8	198.5	114.7	152.3	190.0	105.9	143.5	181.2	96.9	134.5	172.0	87.5	124.9	162.3		
76		TC	-	338.2	338.2	-	320.7	320.7	-	302.2	302.2	-	282.4	282.4	-	261.4	261.4		
		SHC	-	132.1	172.5	-	123.7	163.8	-	115.1	154.8	-	106.0	145.5	-	96.6	135.8		
9000 Cfm		EAT (wb)	58	TC	260.7	260.7	295.1	248.1	248.1	281.5	234.9	234.9	266.9	220.4	220.4	251.1	205.1	205.1	234.1
				SHC	226.2	260.7	295.1	214.9	248.1	281.5	202.9	234.9	266.9	189.9	220.4	251.1	176.1	205.1	234.1
	62		TC	266.1	266.1	288.6	251.9	251.9	279.4	237.0	237.0	269.4	221.2	221.2	258.1	205.2	205.2	244.0	
			SHC	206.5	247.6	288.6	197.6	238.6	279.4	188.4	228.8	269.4	178.2	218.1	258.1	166.5	205.2	244.0	
	67		TC	291.0	291.0	291.0	275.2	275.2	275.2	258.3	258.3	258.3	240.4	240.4	240.4	221.2	221.2	221.2	
			SHC	167.0	208.6	250.1	158.4	199.9	241.4	149.5	190.9	232.3	140.2	181.5	223.0	130.5	171.8	213.1	
	72	TC	320.5	320.5	320.5	303.5	303.5	303.5	285.4	285.4	285.4	266.1	266.1	266.1	245.6	245.6	245.6		
		SHC	126.9	169.0	211.0	118.5	160.4	202.3	109.6	151.5	193.3	100.4	142.3	184.0	90.9	132.5	174.1		
	76	TC	-	345.2	345.2	-	327.2	327.2	-	308.0	308.0	-	287.6	287.6	-	266.1	266.1		
		SHC	-	136.9	181.3	-	128.4	172.5	-	119.6	163.4	-	110.5	154.0	-	100.9	144.2		
	10150 Cfm	EAT (wb)	58	TC	270.4	270.4	306.0	257.3	257.3	291.6	243.4	243.4	276.4	228.5	228.5	260.0	212.6	212.6	242.4
				SHC	234.8	270.4	306.0	223.0	257.3	291.6	210.4	243.4	276.4	197.0	228.5	260.0	182.6	212.6	242.4
62			TC	272.9	272.9	307.7	258.6	258.6	297.6	243.4	243.4	287.3	228.8	228.8	270.9	212.7	212.7	252.6	
			SHC	218.1	263.0	307.7	208.8	253.2	297.6	199.4	243.4	287.3	186.7	228.8	270.9	172.9	212.7	252.6	
67			TC	296.7	296.7	296.7	280.3	280.3	280.3	263.0	263.0	263.0	244.5	244.5	244.5	225.1	225.1	229.2	
			SHC	175.0	220.8	266.7	166.3	212.1	257.9	157.3	203.0	248.7	147.8	193.5	239.3	138.1	183.6	229.2	
72		TC	326.3	326.3	326.3	308.8	308.8	308.8	290.2	290.2	290.2	270.4	270.4	270.4	249.5	249.5	249.5		
		SHC	130.7	177.0	223.3	122.1	168.3	214.5	113.1	159.2	205.3	103.8	149.9	195.9	94.2	140.1	185.9		
76		TC	-	351.3	351.3	-	332.7	332.7	-	313.0	313.0	-	292.1	292.1	-	270.0	270.0		
		SHC	-	141.5	189.9	-	132.9	181.2	-	123.9	172.0	-	114.8	162.5	-	105.1	152.6		
11250 Cfm		EAT (wb)	58	TC	278.5	278.5	314.9	264.8	264.8	300.1	250.5	250.5	284.3	235.1	235.1	267.3	218.6	218.6	249.1
				SHC	241.9	278.5	314.9	229.6	264.8	300.1	216.6	250.5	284.3	202.8	235.1	267.3	188.0	218.6	249.1
	62		TC	278.4	278.4	327.1	264.9	264.9	311.9	250.8	250.8	295.9	235.4	235.4	278.4	218.8	218.8	259.5	
			SHC	229.6	278.4	327.1	217.9	264.9	311.9	205.5	250.8	295.9	192.3	235.4	278.4	177.9	218.8	259.5	
	67		TC	301.0	301.0	301.0	284.3	284.3	284.3	266.6	266.6	266.6	248.0	248.0	254.0	228.2	228.2	243.8	
			SHC	182.2	232.1	281.8	173.5	223.2	272.9	164.3	214.0	263.7	154.8	204.5	254.0	144.9	194.3	243.8	
	72	TC	330.8	330.8	330.8	313.0	313.0	313.0	293.9	293.9	293.9	273.8	273.8	273.8	252.4	252.4	252.4		
		SHC	133.9	184.2	234.4	125.3	175.4	225.5	116.2	166.2	216.3	106.9	156.8	206.7	97.1	146.9	196.7		
	76	TC	-	356.0	356.0	-	337.0	337.0	-	316.8	316.8	-	295.5	295.5	-	273.0	273.0		
		SHC	-	145.6	197.9	-	136.9	189.1	-	127.9	179.8	-	118.6	170.2	-	108.8	160.3		

LEGEND:

- - Do not operate
- Cfm - Cubic feet per minute (supply air)
- EAT (db) - Entering Air Temperature (dry bulb)
- EAT (wb) - Entering Air Temperature (wet bulb)
- SHC - Sensible Heat Capacity (1000 Btuh) Gross
- TC - Total Capacity (1000 Btuh) Gross

50LC*A26 REHEAT MODE #1 CAPACITIES (MBTUH), STANDARD UNITS

Reheat-1 (Subcooler Mode)		AIR ENTERING EVAPORATOR - SCFM/BF (80db)								
		6750			9000			11250		
Outdoor Air Temp ° F		Air Entering Evaporator -- Ewb (F)								
		72	67	62	72	67	62	72	67	62
75	TC	291	288	259	337	303	274	344	310	284
	SHC	116	171	203	157	198	239	170	220	270
	kW	30.0	20.3	19.8	22.7	22.1	21.4	24.7	24.0	23.2
85	TC	301	270	242	316	284	257	323	290	265
	SHC	123	155	187	139	180	223	151	201	252
	kW	22.6	22.0	21.5	24.4	23.8	23.2	26.4	25.8	24.9
95	TC	282	252	225	294	264	238	301	270	246
	SHC	105	138	171	119	162	206	131	183	234
	kW	24.6	24.0	23.4	26.3	25.7	25.1	28.4	27.7	26.8
105	TC	261	233	208	273	244	219	278	248	226
	SHC	86	121	155	100	144	188	110	163	215
	kW	26.8	26.2	25.6	28.6	27.9	27.3	30.6	29.9	29.0
115	TC	240	213	189	250	223	200	254	226	206
	SHC	68	103	138	79	124	170	89	143	196
	kW	29.2	28.6	28.1	31.0	30.4	29.7	33.0	32.3	31.4
125	TC	218	192	170	227	200	179	229	203	184
	SHC	48	84	121	59	105	151	67	122	176
	kW	32.0	31.4	30.8	33.8	33.1	32.4	35.7	35.0	34.1

LEGEND AND NOTES

- kW --- Compressor Power Input
- SHC --- Sensible Heat Capacity (1000 Btuh) Gross
- TC --- Total Capacity (1000 Btuh) Gross

50LC*A26 REHEAT MODE #2 CAPACITIES (MBTUH), STANDARD UNITS

Reheat-2 (Hot Gas Reheat Mode)		AIR ENTERING EVAPORATOR - SCFM/BF (80db)								
		6750			9000			11250		
Outdoor Air Temp ° F		Air Entering Evaporator -- Ewb (F)								
		62.5	64	65.3	62.5	64	65.3	62.5	64	65.3
80	TC	119	124	128	125	130	133	129	133	137
	SHC	31	18	7	49	33	19	67	48	31
	kW	22.3	22.7	23.0	22.8	23.1	23.4	23.0	23.4	23.6
75	TC	127	132	136	133	138	142	137	141	145
	SHC	38	26	15	56	40	26	75	56	39
	kW	21.3	21.7	21.9	21.8	22.1	22.4	22.1	22.3	22.6
70	TC	134	139	143	141	146	150	145	150	154
	SHC	45	33	22	64	48	34	82	63	47
	kW	20.4	20.7	21.0	20.8	21.1	21.4	21.1	21.4	21.7
60	TC	149	154	159	157	162	166	161	166	170
	SHC	60	47	36	78	63	49	98	79	63
	kW	18.6	18.9	19.2	19.1	19.4	19.6	19.4	19.7	19.9
50	TC	164	169	174	172	178	182	177	182	187
	SHC	74	62	51	94	78	65	113	95	79
	kW	17.1	17.4	17.6	17.5	17.8	18.1	17.8	18.1	18.4
40	TC	179	185	190	188	194	199	193	199	204
	SHC	89	77	67	109	94	81	129	111	96
	kW	15.7	16.0	16.3	16.2	16.5	16.7	16.5	16.7	17.0

LEGEND AND NOTES

- kW --- Compressor Power Input
- SHC --- Sensible Heat Capacity (1000 Btuh) Gross
- TC --- Total Capacity (1000 Btuh) Gross

Table 31 – STATIC PRESSURE ADDERS (IN. WG) (FACTORY OPTIONS AND/OR ACCESSORIES)

Ultra Low Leak Economizers

12.5 – 23 Tons								
CFM	3750	4250	4750	5250	5750	6250	6750	7250
Pressure Drop (in. wg)	0.04	0.04	0.05	0.06	0.06	0.07	0.07	0.08
CFM	7750	8250	8750	9250	9750	10250	10750	11250
Pressure Drop (in. wg)	0.08	0.09	0.08	0.10	0.10	0.11	0.11	0.12

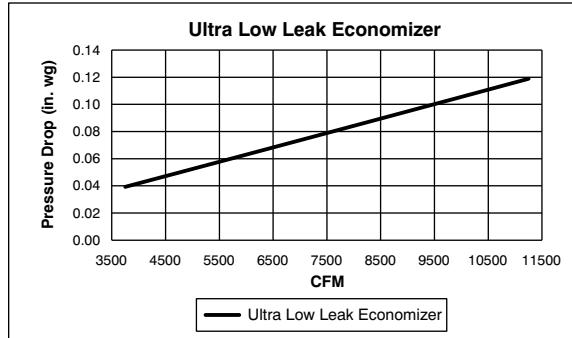

C160063

Humidi-MiZer® Coil

12.5 Tons								
CFM	2500	2750	3000	3250	3500	3750	4000	4250
Pressure Drop (in. wg)	0.02	0.02	0.02	0.02	0.03	0.03	0.03	0.03
CFM	4500	4750	5000	5250	5500	5750	6000	6250
Pressure Drop (in. wg)	0.04	0.04	0.04	0.04	0.05	0.05	0.05	0.06

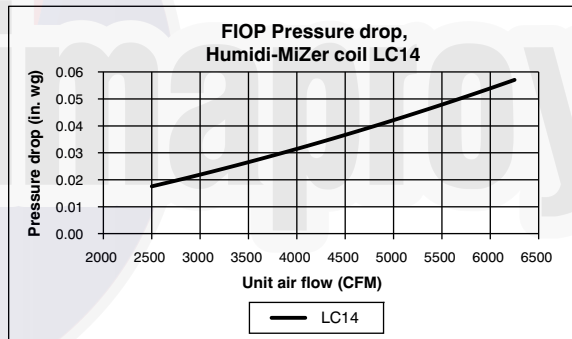

C160077

15 – 23 Tons								
CFM	3750	4250	4750	5250	5750	6250	6750	7250
Pressure Drop (in. wg)	0.02	0.03	0.03	0.04	0.04	0.05	0.05	0.06
CFM	7750	8250	8750	9250	9750	10250	10750	11250
Pressure Drop (in. wg)	0.06	0.07	0.07	0.08	0.09	0.09	0.10	0.11

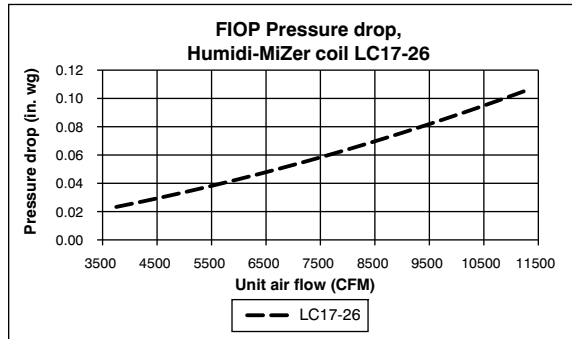

C160078

Table 31 (cont.) - STATIC PRESSURE ADDERS (IN. WG) (FACTORY OPTIONS AND/OR ACCESSORIES)

Electric Heaters

12.5 – 23 Tons																
CFM	3750	4250	4750	5250	5750	6250	6750	7250	7750	8250	8750	9250	9750	10250	10750	11250
25kW	0.00	0.01	0.01	0.01	0.02	0.02	0.03	0.03	0.04	0.04	0.05	0.05	0.06	0.07	0.08	0.08
50kW	0.01	0.01	0.02	0.03	0.03	0.04	0.05	0.06	0.07	0.08	0.10	0.11	0.12	0.14	0.15	0.17
75kW	0.01	0.02	0.03	0.04	0.05	0.06	0.08	0.09	0.11	0.13	0.14	0.16	0.18	0.21	0.23	0.25

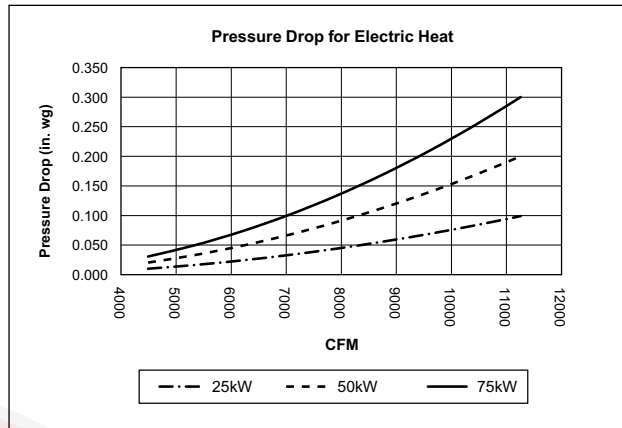

C160068

ECONOMIZER, BAROMETRIC RELIEF AND PE PERFORMANCE

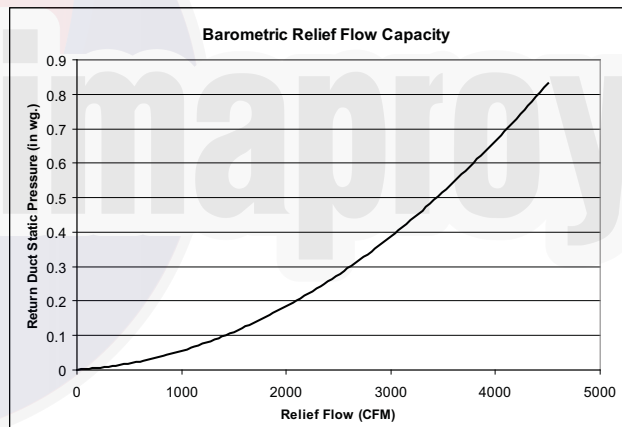

C13107

Fig. 14 - Barometric Pressure Drop

Power Exhaust Fan Performance

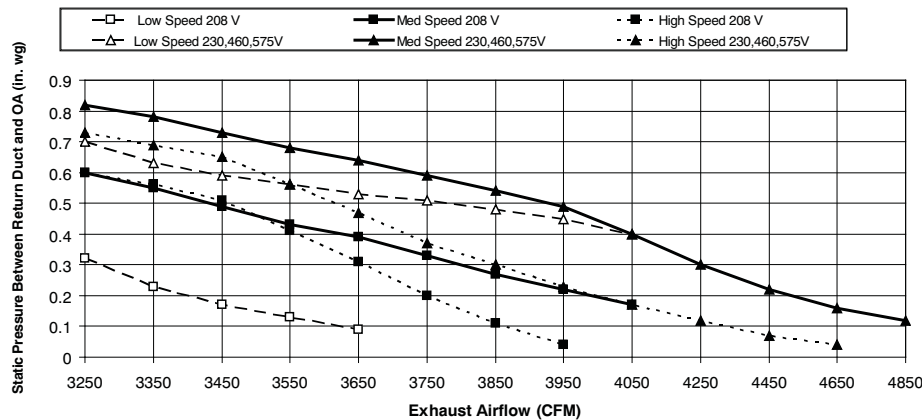

Fig. 15 - Power Exhaust Fan Performance

C09270A

GENERAL FAN PERFORMANCE NOTES:

1. Interpolation is permissible. Do not extrapolate.
2. External static pressure is the static pressure difference between the return duct and the supply duct plus the static pressure caused by any FIOPs or accessories.
3. Tabular data accounts for pressure loss due to clean filters, unit casing, and wet coils. Factory options and accessories may add static pressure losses. Selection software is available, through your salesperson, to help you select the best motor/drive combination for your application.
4. The Fan Performance tables offer motor/drive recommendations. In cases when two motor/drive combinations would work, Carrier recommended the lower horsepower option.
5. For information on the electrical properties of Carrier motors, please see the Electrical information section of this book.
6. For more information on the performance limits of Carrier motors, see the application data section of this book.
7. The EPACT (Energy Policy Act) regulates energy requirements for specific types of indoor fan motors. Motors regulated by EPACT include any general purpose, T-frame (three-digit, 143 and larger), single-speed, foot mounted, polyphase, squirrel cage induction motors of NEMA (National Electrical Manufacturers Association) design A and B, manufactured for use in the United States. Ranging from 1 to 200 Hp, these continuous-duty motors operate on 230 and 460 volt, 60 Hz power. If a motor does not fit into these specifications, the motor does not have to be replaced by an EPACT compliant energy-efficient motor. Variable-speed motors are exempt from EPACT compliance requirements.



FAN PERFORMANCE

Table 32 – 50LC**14

12.5 TON VERTICAL SUPPLY

CFM	Available External Static Pressure (in. wg)																			
	0.2		0.4		0.6		0.8		1.0		1.2		1.4		1.6		1.8		2.0	
	RPM	BHP	RPM	BHP	RPM	BHP	RPM	BHP	RPM	BHP	RPM	BHP	RPM	BHP	RPM	BHP	RPM	BHP	RPM	BHP
3750	413	0.41	514	0.61	600	0.82	673	1.03	738	1.25	797	1.46	851	1.68	901	1.90	948	2.12	992	2.34
4063	429	0.49	526	0.70	610	0.93	684	1.15	749	1.39	807	1.62	861	1.85	912	2.09	958	2.32	1003	2.56
4375	447	0.57	539	0.80	621	1.04	694	1.28	759	1.53	818	1.78	872	2.03	922	2.28	969	2.53	1013	2.79
4688	466	0.67	553	0.91	633	1.16	705	1.42	769	1.69	828	1.95	882	2.22	932	2.49	979	2.76	1024	3.03
5000	485	0.78	568	1.03	645	1.30	716	1.57	779	1.85	838	2.14	892	2.42	942	2.70	990	2.99	1034	3.28
5313	505	0.90	584	1.16	659	1.44	727	1.74	790	2.03	848	2.33	902	2.63	952	2.93	1000	3.23	1045	3.54
5625	525	1.04	600	1.31	672	1.61	739	1.91	801	2.22	859	2.54	912	2.85	963	3.17	1010	3.49	1055	3.81
5938	546	1.20	618	1.48	687	1.78	752	2.10	813	2.42	870	2.75	923	3.09	973	3.42	1020	3.76	1065	4.10
6250	568	1.37	636	1.66	702	1.97	765	2.30	825	2.64	881	2.99	934	3.34	983	3.69	1030	4.04	1075	4.39

STD Static (498 – 676 rpm) 2.9 Max BHP MID Static (682 – 861 rpm) 4.9 Max BHP HIGH Static (782 – 963 rpm) 7.4 Max BHP Ultra High Static (933 – 1113 rpm) 9.9 Max BHP

Bold Face = Field Supplied Drive (Standard motor, motor pulley = KR11HY163, blower pulley = KR51BM415, belt = KR29AF049) 368 – 509 rpm

Table 33 – 50LC**14

12.5 TON HORIZONTAL SUPPLY

CFM	Available External Static Pressure (in. wg)																			
	0.2		0.4		0.6		0.8		1.0		1.2		1.4		1.6		1.8		2.0	
	RPM	BHP	RPM	BHP	RPM	BHP	RPM	BHP	RPM	BHP	RPM	BHP	RPM	BHP	RPM	BHP	RPM	BHP	RPM	BHP
3750	426	0.62	513	1.01	584	1.43	645	1.88	700	2.36	749	2.85	794	3.36	836	3.88	875	4.42	913	4.98
4063	445	0.72	530	1.13	600	1.58	661	2.05	715	2.55	764	3.06	809	3.60	851	4.15	891	4.71	928	5.29
4375	465	0.83	547	1.27	617	1.74	677	2.24	731	2.75	780	3.29	825	3.85	867	4.42	906	5.01	944	5.62
4688	485	0.95	565	1.41	633	1.91	693	2.43	747	2.97	795	3.54	840	4.12	882	4.71	922	5.33	959	5.95
5000	506	1.09	584	1.58	650	2.09	709	2.64	762	3.21	811	3.79	856	4.40	898	5.02	937	5.65	974	6.31
5313	527	1.25	602	1.75	668	2.29	726	2.86	779	3.45	827	4.06	871	4.69	913	5.34	953	6.00	990	6.67
5625	549	1.42	622	1.95	686	2.51	743	3.10	795	3.72	843	4.35	887	5.00	929	5.67	968	6.36	1005	7.06
5938	571	1.61	641	2.16	704	2.74	760	3.36	812	4.00	859	4.66	903	5.33	945	6.03	984	6.73	1021	7.46
6250	593	1.82	661	2.39	722	3.00	778	3.64	829	4.30	876	4.98	919	5.68	961	6.40	1000	7.13	1037	7.87

STD Static (498 – 676 rpm) 2.9 Max BHP MID Static (644 – 808 rpm) 4.9 Max BHP* HIGH Static (707 – 888 rpm) 7.4 Max BHP Ultra High Static (872 – 1053 rpm) 9.9 Max BHP

*At 575V, Max BPH is 4.7

Bold Face = Field Supplied Drive (Standard motor, motor pulley = KR11HY163, blower pulley = KR51BM415, belt = KR29AF049) 368 – 509 rpm

FAN PERFORMANCE (cont.)

Table 34 – 50LC17**

15 TON VERTICAL SUPPLY

CFM	Available External Static Pressure (in. wg)																			
	0.2		0.4		0.6		0.8		1.0		1.2		1.4		1.6		1.8		2.0	
	RPM	BHP	RPM	BHP	RPM	BHP	RPM	BHP	RPM	BHP	RPM	BHP	RPM	BHP	RPM	BHP	RPM	BHP	RPM	BHP
4500	420	0.55	535	0.88	620	1.19	689	1.48	751	1.79	809	2.10	864	2.43	917	2.78	968	3.14	1018	3.53
4875	439	0.65	547	0.99	634	1.34	703	1.66	764	1.99	821	2.32	874	2.66	925	3.01	975	3.38	1023	3.77
5250	460	0.77	557	1.11	647	1.50	717	1.86	778	2.20	834	2.55	886	2.91	936	3.28	983	3.66	1030	4.05
5625	483	0.91	568	1.24	659	1.67	731	2.06	793	2.44	848	2.81	899	3.18	948	3.56	994	3.96	1039	4.36
6000	508	1.08	580	1.38	670	1.84	745	2.27	807	2.68	862	3.08	913	3.47	961	3.87	1006	4.28	1050	4.70
6375	534	1.26	595	1.55	681	2.01	757	2.49	821	2.94	877	3.37	927	3.79	975	4.21	1019	4.63	1062	5.07
6750	560	1.47	613	1.74	691	2.20	769	2.72	834	3.21	891	3.67	942	4.12	989	4.56	1033	5.01	1076	5.46
7125	587	1.71	633	1.97	702	2.40	779	2.95	847	3.48	904	3.98	956	4.46	1003	4.94	1047	5.41	1090	5.88
7500	615	1.97	655	2.22	716	2.63	790	3.19	858	3.76	917	4.31	970	4.83	1017	5.33	1062	5.83	1104	6.32

STD Static (498 – 676 rpm) 2.9 Max BHP

MID Static (651 – 818 rpm) 7.4 Max BHP

HIGH Static (804 – 970 rpm) 9.9 Max BHP

ULTRA HIGH Static (948 – 1190 rpm) 13.6 Max BHP

Bold Face = Field Supplied Drive (Standard motor [HD58FE654], motor pulley = KR11HY216, blower pulley = KR51BN615, belt = KR29BF052) 403 – 529 rpm

Table 35 – 50LC17**

15 TON HORIZONTAL SUPPLY

CFM	Available External Static Pressure (in. wg)																			
	0.2		0.4		0.6		0.8		1.0		1.2		1.4		1.6		1.8		2.0	
	RPM	BHP	RPM	BHP	RPM	BHP	RPM	BHP	RPM	BHP	RPM	BHP	RPM	BHP	RPM	BHP	RPM	BHP	RPM	BHP
4500	466	1.00	546	1.48	615	2.01	677	2.59	732	3.21	783	3.85	829	4.52	873	5.22	914	5.94	953	6.68
4875	491	1.19	567	1.69	634	2.25	695	2.86	749	3.50	799	4.17	846	4.87	889	5.59	930	6.34	969	7.11
5250	517	1.40	589	1.93	654	2.51	713	3.14	767	3.81	817	4.51	863	5.24	906	5.99	947	6.77	986	7.56
5625	543	1.65	612	2.20	674	2.80	732	3.46	785	4.15	834	4.88	880	5.63	923	6.42	964	7.22	1002	8.05
6000	570	1.93	635	2.50	696	3.13	752	3.81	804	4.53	852	5.28	897	6.06	940	6.87	980	7.70	1019	8.55
6375	598	2.24	660	2.83	718	3.49	772	4.19	823	4.93	870	5.71	915	6.52	957	7.35	998	8.21	1036	9.09
6750	626	2.59	685	3.20	740	3.88	793	4.60	843	5.37	889	6.17	933	7.01	975	7.87	1015	8.75	1053	9.66
7125	654	2.98	710	3.62	764	4.31	815	5.06	863	5.85	909	6.67	952	7.53	993	8.42	1033	9.33	1070	10.27
7500	683	3.41	736	4.07	788	4.78	837	5.55	884	6.37	929	7.22	971	8.10	1012	9.01	1051	9.95	1088	10.91

STD Static (498 – 676 rpm) 2.9 Max BHP

MID Static (651 – 818 rpm) 7.4 Max BHP

HIGH Static (804 – 970 rpm) 9.9 Max BHP

ULTRA HIGH Static (948 – 1190 rpm) 13.6 Max BHP

Bold Face = Field Supplied Drive (Standard motor [HD58FE654], motor pulley = KR11HY216, blower pulley = KR51BN615, belt = KR29BF052) 403 – 529 rpm

FAN PERFORMANCE (cont.)

17.5 TON VERTICAL SUPPLY

Table 36 – 50LC**20

CFM	Available External Static Pressure (in. wg)																			
	0.2		0.4		0.6		0.8		1.0		1.2		1.4		1.6		1.8		2.0	
	RPM	BHP	RPM	BHP	RPM	BHP	RPM	BHP	RPM	BHP	RPM	BHP	RPM	BHP	RPM	BHP	RPM	BHP	RPM	BHP
5250	460	0.77	557	1.11	647	1.50	717	1.86	778	2.20	834	2.55	886	2.91	936	3.27	983	3.66	1030	4.05
5688	487	0.94	569	1.26	661	1.69	734	2.09	795	2.47	850	2.85	901	3.23	950	3.61	996	4.01	1041	4.41
6125	517	1.14	584	1.43	674	1.89	749	2.34	812	2.76	867	3.17	918	3.58	965	3.98	1011	4.40	1054	4.82
6563	547	1.37	603	1.64	696	2.11	763	2.60	828	3.07	884	3.52	934	3.95	982	4.38	1026	4.82	1069	5.26
7000	578	1.63	626	1.89	698	2.33	776	2.87	842	3.39	900	3.88	951	4.35	998	4.81	1043	5.27	1085	5.74
7438	610	1.93	651	2.18	713	2.59	788	3.15	856	3.72	915	4.25	967	4.76	1015	5.26	1059	5.75	1101	6.25
7875	642	2.26	678	2.51	731	2.89	800	3.44	869	4.05	929	4.64	983	5.20	1031	5.74	1076	6.26	1118	6.78
8313	675	2.64	707	2.88	752	3.24	814	3.77	881	4.40	943	5.03	998	5.64	1047	6.23	1092	6.79	1135	7.35
8750	707	3.06	737	3.30	776	3.64	830	4.13	893	4.77	955	5.44	1011	6.10	1062	6.73	1108	7.34	1151	7.94

STD Static (555 – 753 rpm) 2.9 Max BHP MID Static (707 – 888 rpm) 7.4 Max BHP HIGH Static (672 – 1053 rpm) 9.9 Max BHP ULTRA HIGH Static (948 – 1190 rpm) 13.6 Max BHP

Bold Face = Field Supplied Drive (Standard Motor [HD60FE656], motor pulley = KR11HY216, blower pulley = KR51BM415, belt = KR29BF050) 435 – 570 rpm

17.5 TON HORIZONTAL SUPPLY

Table 37 – 50LC**20

CFM	Available External Static Pressure (in. wg)																			
	0.2		0.4		0.6		0.8		1.0		1.2		1.4		1.6		1.8		2.0	
	RPM	BHP	RPM	BHP	RPM	BHP	RPM	BHP	RPM	BHP	RPM	BHP	RPM	BHP	RPM	BHP	RPM	BHP	RPM	BHP
5250	517	1.40	589	1.93	654	2.51	713	3.14	767	3.81	817	4.51	863	5.24	906	5.99	947	6.77	986	7.56
5688	548	1.70	615	2.24	678	2.86	735	3.52	788	4.21	837	4.94	883	5.70	926	6.49	966	7.30	1005	8.13
6125	580	2.03	643	2.61	703	3.24	758	3.93	810	4.66	858	5.42	903	6.21	946	7.02	986	7.87	1024	8.73
6563	612	2.41	672	3.01	729	3.68	783	4.39	833	5.15	880	5.94	924	6.76	966	7.60	1006	8.48	1044	9.37
7000	645	2.85	702	3.47	756	4.16	807	4.90	856	5.68	902	6.50	946	7.35	987	8.23	1027	9.14	1064	10.06
7438	678	3.34	732	3.99	784	4.70	833	5.47	881	6.28	925	7.12	968	8.00	1009	8.91	1048	9.84	1085	10.80
7875	712	3.88	763	4.56	812	5.30	860	6.09	906	6.93	949	7.80	991	8.71	1031	9.64	1069	10.61	–	–
8313	746	4.49	794	5.19	841	5.96	887	6.78	931	7.64	974	8.54	1015	9.47	1054	10.44	1092	11.43	–	–
8750	780	5.16	826	5.89	871	6.68	915	7.53	958	8.41	999	9.34	1039	10.30	1077	11.29	–	–	–	–

STD Static (555 – 753 rpm) 2.9 Max BHP MID Static (651 – 818 rpm) 7.4 Max BHP HIGH Static (804 – 970 rpm) 9.9 Max BHP ULTRA HIGH Static (948 – 1190 rpm) 13.6 Max BHP

Bold Face = Field Supplied Drive (Standard Motor [HD60FE656], motor pulley = KR11HY216, blower pulley = KR51BM415, belt = KR29BF050) 435 – 570 rpm

FAN PERFORMANCE (cont.)

Table 38 – 50LC**24

20 TON VERTICAL SUPPLY

CFM	Available External Static Pressure (in. wg)																			
	0.2		0.4		0.6		0.8		1.0		1.2		1.4		1.6		1.8		2.0	
	RPM	BHP	RPM	BHP	RPM	BHP	RPM	BHP	RPM	BHP	RPM	BHP	RPM	BHP	RPM	BHP	RPM	BHP	RPM	BHP
6000	508	1.08	580	1.38	670	1.84	745	2.27	807	2.68	862	3.08	913	3.47	961	3.87	1006	4.28	1050	4.70
6500	543	1.33	600	1.61	684	2.07	761	2.57	825	3.03	881	3.47	932	3.90	979	4.33	1024	4.76	1067	5.19
7000	578	1.63	626	1.89	698	2.33	776	2.87	842	3.39	900	3.88	951	4.35	998	4.81	1043	5.27	1085	5.74
7500	615	1.97	655	2.22	716	2.63	790	3.19	858	3.76	917	4.31	970	4.83	1017	5.33	1062	5.83	1104	6.32
8000	651	2.37	686	2.61	737	2.99	804	3.53	872	4.15	933	4.75	987	5.32	1036	5.88	1081	6.41	1123	6.94
8500	689	2.81	720	3.05	762	3.41	820	3.92	886	4.55	948	5.21	1004	5.84	1054	6.44	1099	7.03	1142	7.60
9000	726	3.32	754	3.56	791	3.89	840	4.37	900	4.99	962	5.68	1019	6.37	1070	7.03	1117	7.67	1160	8.29
9500	764	3.87	789	4.12	822	4.44	864	4.88	917	5.47	976	6.18	1033	6.91	1086	7.63	1134	8.33	1178	9.00
10000	802	4.50	825	4.74	854	5.05	891	5.47	937	6.03	991	6.71	1047	7.48	1100	8.25	1149	9.00	1195	9.73

STD Static (583 – 717 rpm) 7.4 Max BHP

MID Static (707 – 888 rpm) 7.4 Max BHP

HIGH Static (872 – 1053 rpm) 9.9 Max BHP

ULTRA HIGH Static (1049 – 1291 rpm) 13.6 Max BHP

Bold Face = Field Supplied Drive (Standard Motor [HD60FE657], motor pulley = KR11HY229, blower pulley = KR51BQ415, belt = KR29BF056) 493 – 605 rpm

Table 39 – 50LC**24

20 TON HORIZONTAL SUPPLY

CFM	Available External Static Pressure (in. wg)																			
	0.2		0.4		0.6		0.8		1.0		1.2		1.4		1.6		1.8		2.0	
	RPM	BHP	RPM	BHP	RPM	BHP	RPM	BHP	RPM	BHP	RPM	BHP	RPM	BHP	RPM	BHP	RPM	BHP	RPM	BHP
6000	570	1.93	635	2.50	696	3.13	752	3.81	804	4.53	852	5.28	897	6.06	940	6.87	980	7.70	1019	8.55
6500	607	2.36	668	2.95	725	3.61	779	4.32	829	5.07	877	5.86	921	6.68	963	7.52	1003	8.39	1041	9.28
7000	645	2.85	702	3.47	756	4.16	807	4.90	856	5.68	902	6.50	946	7.35	987	8.23	1027	9.14	1064	10.06
7500	683	3.41	736	4.07	788	4.78	837	5.55	884	6.37	929	7.22	971	8.10	1012	9.01	1051	9.95	1088	10.91
8000	721	4.05	772	4.74	821	5.48	868	6.28	913	7.12	956	8.00	998	8.92	1037	9.86	1076	10.84	1112	11.83
8500	760	4.77	808	5.48	854	6.26	899	7.09	943	7.96	985	8.87	1025	9.82	1064	10.80	1101	11.80	1137	12.83
9000	799	5.57	844	6.32	889	7.13	932	7.98	974	8.88	1014	9.83	1053	10.80	1091	11.81	1128	12.85	-	-
9500	839	6.46	882	7.25	924	8.08	965	8.97	1005	9.90	1044	10.87	1082	11.88	1119	12.91	-	-	-	-
10000	879	7.45	919	8.27	960	9.14	999	10.05	1038	11.01	1075	12.01	1112	13.05	-	-	-	-	-	-

STD Static (583 – 717 rpm) 7.4 Max BHP

MID Static (707 – 888 rpm) 7.4 Max BHP

HIGH Static (872 – 1053 rpm) 9.9 Max BHP

ULTRA HIGH Static (948 – 1190 rpm) 13.6 Max BHP

Bold Face = Field Supplied Drive (Standard Motor [HD60FE657], motor pulley = KR11HY229, blower pulley = KR51BQ415, belt = KR29BF056) 493 – 605 rpm

FAN PERFORMANCE (cont.)

Table 40 – 50LC26**

23 TON VERTICAL SUPPLY

CFM	Available External Static Pressure (in. wg)																			
	0.2		0.4		0.6		0.8		1.0		1.2		1.4		1.6		1.8		2.0	
	RPM	BHP	RPM	BHP	RPM	BHP	RPM	BHP	RPM	BHP	RPM	BHP	RPM	BHP	RPM	BHP	RPM	BHP	RPM	BHP
6750	560	1.47	613	1.74	691	2.20	769	2.72	834	3.21	891	3.67	942	4.12	989	4.56	1033	5.01	1076	5.46
7313	601	1.84	644	2.09	709	2.52	785	3.07	852	3.62	911	4.14	963	4.64	1010	5.13	1055	5.61	1097	6.10
7875	642	2.27	678	2.51	731	2.89	800	3.45	869	4.05	930	4.64	983	5.20	1031	5.74	1076	6.26	1118	6.79
8438	684	2.76	715	3.00	759	3.35	818	3.87	884	4.50	947	5.15	1002	5.77	1052	6.37	1097	6.95	1140	7.52
9000	726	3.32	754	3.56	791	3.89	840	4.37	900	4.99	962	5.68	1019	6.37	1070	7.03	1117	7.67	1160	8.29
9563	769	3.95	794	4.19	826	4.51	867	4.95	919	5.54	978	6.24	1035	6.98	1088	7.71	1136	8.41	1180	9.09
10125	811	4.66	834	4.91	862	5.22	898	5.63	942	6.18	995	6.86	1050	7.62	1104	8.41	1153	9.18	1199	9.92
10688	854	5.46	875	5.71	900	6.01	931	6.41	969	6.92	1015	7.56	1067	8.31	1119	9.13	1169	9.96	1216	10.77
11250	897	6.34	917	6.59	939	6.90	967	7.28	1000	7.76	1039	8.36	1085	9.08	1135	9.90	1185	10.77	1232	11.64

STD Static (651 – 818 rpm) 7.4 Max BHP

MID Static (804 – 970 rpm) 9.9 Max BHP

HIGH Static (948 – 1190 rpm) 13.6 Max BHP

Bold Face = Field Supplied Drive (Standard Motor [HD60FK657], motor pulley = KR11HY194, blower pulley = KR51BQ415, belt = KR29BF057) 527 – 661 rpm

Italics = Field Supplied drive (High Static Motor, motor pulley = KR12HY118, blower pulley = KR52BH615, belts = KR29BF034) 1049 – 1291 rpm

Table 41 – 50LC26**

23 TON HORIZONTAL SUPPLY

CFM	Available External Static Pressure (in. wg)																			
	0.2		0.4		0.6		0.8		1.0		1.2		1.4		1.6		1.8		2.0	
	RPM	BHP	RPM	BHP	RPM	BHP	RPM	BHP	RPM	BHP	RPM	BHP	RPM	BHP	RPM	BHP	RPM	BHP	RPM	BHP
6750	626	2.59	685	3.20	740	3.88	793	4.60	843	5.37	889	6.17	933	7.01	975	7.87	1015	8.75	1053	9.66
7313	668	3.19	723	3.84	776	4.54	826	5.30	873	6.10	919	6.94	962	7.81	1003	8.71	1042	9.64	1079	10.59
7875	712	3.88	763	4.56	812	5.30	860	6.09	906	6.93	949	7.80	991	8.71	1031	9.64	1069	10.61	1106	11.60
8438	755	4.67	803	5.39	850	6.16	895	6.98	939	7.85	981	8.76	1021	9.70	1060	10.67	1098	11.68	1134	12.70
9000	799	5.57	844	6.32	889	7.13	932	7.98	974	8.88	1014	9.83	1053	10.80	1091	11.81	1128	12.85	-	-
9563	844	6.58	886	7.37	928	8.21	969	9.10	1009	10.03	1048	11.01	1086	12.02	1123	13.06	-	-	-	-
10125	889	7.72	929	8.54	969	9.42	1008	10.34	1046	11.30	1083	12.31	1120	13.35	-	-	-	-	-	-
10688	933	8.98	972	9.84	1010	10.75	1047	11.71	1083	12.71	-	-	-	-	-	-	-	-	-	-
11250	979	10.38	1015	11.28	1051	12.22	1087	13.21	-	-	-	-	-	-	-	-	-	-	-	-

STD Static (707 – 888 rpm) 7.4 Max BHP

MID Static (859 – 1026 rpm) 9.9 Max BHP

HIGH Static (948 – 1190 rpm) 13.6 Max BHP

Bold Face = Field Supplied Drive (Standard Motor [HD60FK657], motor pulley = KR11HY232, blower pulley = KR51BQ415, belt = KR29BF059) 583 – 717 rpm

FAN PERFORMANCE (cont.)

Table 42 – PULLEY ADJUSTMENT

VERTICAL

UNIT	MOTOR/ DRIVE COMBO	MOTOR PULLEY TURNS OPEN (RPM)												
		0.0	0.5	1.0	1.5	2.0	2.5	3.0	3.5	4.0	4.5	5.0	5.5	6.0
14	Standard Static	N/A	N/A	676	658	640	623	605	587	569	551	534	516	498
	Medium Static	N/A	N/A	861	843	825	807	789	772	754	736	718	700	682
	High Static	963	948	933	918	903	888	873	857	842	827	812	797	782
	Ultra High Static	1113	1098	1083	1068	1053	1038	1023	1008	993	978	963	948	933
17	Standard Static	N/A	N/A	676	658	640	623	605	587	569	551	534	516	498
	Medium Static	818	804	790	776	762	748	735	721	707	693	679	665	651
	High Static	970	956	942	929	915	901	887	873	859	846	832	818	804
	Ultra High Static	1190	1170	1150	1130	1109	1089	1069	1049	1029	1009	988	968	948
20	Standard Static	N/A	N/A	753	733	713	694	674	654	634	614	595	575	555
	Medium Static	888	873	858	843	828	813	798	782	767	752	737	722	707
	High Static	1053	1038	1023	1008	993	978	963	947	932	917	902	887	872
	Ultra High Static	1190	1170	1150	1130	1109	1089	1069	1049	1029	1009	988	968	948
24	Standard Static	717	706	695	684	672	661	650	639	628	617	605	594	583
	Medium Static	888	873	858	843	828	813	798	782	767	752	737	722	707
	High Static	1053	1038	1023	1008	993	978	963	947	932	917	902	887	872
	Ultra High Static	1291	1271	1251	1231	1210	1190	1170	1150	1130	1110	1089	1069	1049
26	Standard Static	818	804	790	776	762	748	735	721	707	693	679	665	651
	Medium Static	970	956	942	929	915	901	887	873	859	846	832	818	804
	High Static	1190	1170	1150	1130	1109	1089	1069	1049	1029	1009	988	968	948

■ – Factory settings

FAN PERFORMANCE (cont.)

Table 43 – PULLEY ADJUSTMENT

HORIZONTAL

UNIT	MOTOR/ DRIVE COMBO	MOTOR PULLEY TURNS OPEN (RPM)												
		0.0	0.5	1.0	1.5	2.0	2.5	3.0	3.5	4.0	4.5	5.0	5.5	6.0
14	Standard Static	N/A	N/A	676	658	640	623	605	587	569	551	534	516	498
	Medium Static	808	794	781	767	753	740	726	712	699	685	671	658	644
	High Static	888	873	858	843	828	813	798	782	767	752	737	722	707
	Ultra High Static	1053	1038	1023	1008	993	978	963	947	932	917	902	887	872
17	Standard Static	N/A	N/A	676	658	640	623	605	587	569	551	534	516	498
	Medium Static	818	804	790	776	762	748	735	721	707	693	679	665	651
	High Static	970	956	942	929	915	901	887	873	859	846	832	818	804
	Ultra High Static	1190	1170	1150	1130	1109	1089	1069	1049	1029	1009	988	968	948
20	Standard Static	N/A	N/A	753	733	713	694	674	654	634	614	595	575	555
	Medium Static	818	804	790	776	762	748	735	721	707	693	679	665	651
	High Static	970	956	942	929	915	901	887	873	859	846	832	818	804
	Ultra High Static	1190	1170	1150	1130	1109	1089	1069	1049	1029	1009	988	968	948
24	Standard Static	717	706	695	684	672	661	650	639	628	617	605	594	583
	Medium Static	888	873	858	843	828	813	798	782	767	752	737	722	707
	High Static	1053	1038	1023	1008	993	978	963	947	932	917	902	887	872
	Ultra High Static	1190	1170	1150	1130	1109	1089	1069	1049	1029	1009	988	968	948
26	Standard Static	888	873	858	843	828	813	798	782	767	752	737	722	707
	Medium Static	1026	1012	998	984	970	956	943	929	915	901	887	873	859
	High Static	1190	1170	1150	1130	1109	1089	1069	1049	1029	1009	988	968	948

■ – Factory settings

ELECTRICAL INFORMATION

Table 44 – 50LC*014 - 026

15 - 23 TONS

50LC UNIT	V-Ph-Hz	VOLTAGE RANGE		COMP 1		COMP 2		OFM (ea)		IFM		
		MIN	MAX	RLA	LRA	RLA	LRA	WATTS	FLA	TYPE	EFF at Full Load	FLA
14	208-3-60	187	253	17.6	123	23.2	164	185	1.3	STD	85.0%	8.6
										MED	83.6%	13.6
										HIGH	89.5%	21.2
										ULTRA HIGH	91.7%	28.0
	230-3-60	187	253	17.6	123	23.2	164	185	1.3	STD	85.0%	7.8
										MED	83.6%	12.7
										HIGH	89.5%	21.2
										ULTRA HIGH	91.7%	28.0
	460-3-60	414	506	9.6	62	11.2	75	185	1.3	STD	85.0%	3.8
										MED	83.6%	6.4
										HIGH	89.5%	9.7
										ULTRA HIGH	91.7%	13.7
575-3-60	518	633	6.1	40	7.9	54	185	1.3	STD	81.1%	4.5	
									MED	83.6%	6.2	
									HIGH	89.5%	7.2	
									ULTRA HIGH	91.7%	8.9	
17	208-3-60	187	253	19.1	123	27.6	191	185	1.3	STD	85.0%	8.6
										MED	89.5%	21.2
										HIGH	91.7%	28.0
										ULTRA HIGH	91.7%	37.3
	230-3-60	187	253	19.1	123	27.6	191	185	1.3	STD	85.0%	7.8
										MED	89.5%	21.2
										HIGH	91.7%	28.0
										ULTRA HIGH	91.7%	37.3
	460-3-60	414	506	9.8	62	12.8	100	185	1.3	STD	85.0%	3.8
										MED	89.5%	9.7
										HIGH	91.7%	13.7
										ULTRA HIGH	91.7%	16.9
575-3-60	518	633	7.5	50	10.2	78	185	1.3	STD	81.1%	4.5	
									MED	89.5%	7.2	
									HIGH	91.7%	8.9	
									ULTRA HIGH	91.7%	12.6	
20	208-3-60	187	253	25.0	164	27.6	191	185	1.3	STD	85.0%	8.6
										MED	89.5%	21.2
										HIGH	91.7%	28.0
										ULTRA HIGH	91.7%	37.3
	230-3-60	187	253	25.0	164	27.6	191	185	1.3	STD	85.0%	7.8
										MED	89.5%	21.2
										HIGH	91.7%	28.0
										ULTRA HIGH	91.7%	37.3
	460-3-60	414	506	12.2	100	12.8	100	185	1.3	STD	85.0%	3.8
										MED	89.5%	9.7
										HIGH	91.7%	13.7
										ULTRA HIGH	91.7%	16.9
575-3-60	518	633	9.3	78	10.2	78	185	1.3	STD	81.1%	4.5	
									MED	89.5%	7.2	
									HIGH	91.7%	8.9	
									ULTRA HIGH	91.7%	12.6	

ELECTRICAL INFORMATION (cont.)

Table 44 (cont.) - 50LC*014 - 026

15 - 23 TONS

50LC UNIT	V-Ph-Hz	VOLTAGE RANGE		COMP 1		COMP 2		OFM (ea)		IFM		
		MIN	MAX	RLA	LRA	RLA	LRA	WATTS	FLA	TYPE	EFF at Full Load	FLA
24	208-3-60	187	253	29.5	195	33.3	239	190	1.6	STD	89.5%	21.2
										MED	89.5%	21.2
										HIGH	91.7%	28.0
										ULTRA HIGH	91.7%	37.3
	230-3-60	187	253	29.5	195	33.3	239	190	1.6	STD	89.5%	21.2
										MED	89.5%	21.2
										HIGH	91.7%	28.0
										ULTRA HIGH	91.7%	37.3
	460-3-60	414	506	14.8	95	18.0	125	190	1.6	STD	89.5%	9.7
										MED	89.5%	9.7
										HIGH	91.7%	13.7
										ULTRA HIGH	91.7%	16.9
575-3-60	518	633	12.2	80	12.8	80	190	1.6	STD	89.5%	7.2	
									MED	89.5%	7.2	
									HIGH	91.7%	8.9	
									ULTRA HIGH	91.7%	12.6	
26	208-3-60	187	253	30.1	225	51.2	300	190	1.6	STD	89.5%	21.2
										MED	91.7%	28.0
										HIGH	91.7%	37.3
	230-3-60	187	253	30.1	225	51.2	300	190	1.6	STD	89.5%	21.2
										MED	91.7%	28.0
										HIGH	91.7%	37.3
	460-3-60	414	506	16.7	114	23.1	150	190	1.6	STD	89.5%	9.7
										MED	91.7%	13.7
										HIGH	91.7%	16.9
	575-3-60	518	633	12.2	80	19.9	109	190	1.6	STD	89.5%	7.2
										MED	91.7%	8.9
										HIGH	91.7%	12.6

ELECTRICAL DATA

Table 45 – UNIT WIRE/FUSE OR HACR BREAKER SIZING DATA

UNIT	NO M, V-PH-HZ	ELEC. HTR						NO C.O. or UNPWR C.O.						w/ PWRD C.O.							
		CRHEATER**A00 VERT/HORZ	Nom (kW)	FLA	NO P.E.		w/ P.E. (pwrd frntnt)		MCA	MAX FUSE OF HACR BRKR	DISC. SIZE		MCA	MAX FUSE OF HACR BRKR	NO P.E.		w/ P.E. (pwrd frntnt)				
				FLA	FLA	LRA	MCA	MAX FUSE OF HACR BRKR	FLA	LRA	FLA	LRA	MCA	MAX FUSE OF HACR BRKR	FLA	LRA	MCA	MAX FUSE OF HACR BRKR	FLA	LRA	
50LC**14	460-3-60	STD	NONE	-	-	-	-	59.1158.3	6160	343	75/74	363	63.9/63.1	80/80	67/66	348	75.7/74.9	80/79	80/79	368	
			302/305A00	11.3/15.0	31.3/36.1	31.3/36.1	343/343	70.9/70.1	90/90	6160	343/343	75/74	363/363	63.9/63.1	80/80	67/66	348/348	75.7/75.6	80/90	80/90	368/368
			279/270A00	18.8/25.0	52.1/60.1	52.1/60.1	343/343	83.9/2	81.9/90.9	80/90	7078	83/92	363/363	81.9/90.9	90/100	75/84	348/348	96.6/105.6	100/110	89/97	368/368
			309/312A00	37.6/50.0	104.2/120.3	104.2/120.3	343/343	155.8/144.8	147.0/136.1	150/150	130147	143/161	363/363	147.0/136.1	150/150	135/153	348/348	161.8/150.8	175/175	149/166	368/368
		MED	NONE	-	-	-	-	-	64.1/63.2	80/80	67/66	378	398	68.9/68.0	90/90	73/72	383	80.7/79.8	86/85	100/100	403
			302/305A00	11.3/15.0	31.3/36.1	31.3/36.1	378/378	75.9/75.8	90/90	80/80	67/66	378/378	81/80	68.9/68.0	90/90	73/72	383/383	80.7/81.8	86/85	100/100	403/403
			279/270A00	18.8/25.0	52.1/60.1	52.1/60.1	378/378	96.9/105.8	88.1/97.0	90/100	7684	89/97	398/398	88.1/97.0	90/100	81/89	383/383	102.9/111.8	95/103	100/125	403/403
			309/312A00	37.6/50.0	104.2/120.3	104.2/120.3	378/378	162.0/150.9	153.3/142.2	150/150	147.3/136.2	149/167	398/398	153.3/142.2	175/175	141/158	383/383	168.0/156.9	175/175	155/172	403/403
		HIGH	NONE	-	-	-	-	-	71.7	90	76	382	402	76.5	90	81	387	88.3	88.3	100	407
			302/305A00	11.3/15.0	31.3/36.1	31.3/36.1	382/382	83.5/84.4	83.5/86.4	90/90	7676	382/382	89/89	76.5/77.6	90/90	81/81	387/387	88.3/92.4	95/95	100/100	407/407
			279/270A00	18.8/25.0	52.1/60.1	52.1/60.1	382/382	106.4/116.4	97.6/107.6	100/110	84/93	382/382	98/107	97.6/107.6	100/110	90/99	387/387	112.4/122.4	103/113	100/125	407/407
			309/312A00	37.6/50.0	104.2/120.3	104.2/120.3	382/382	171.5/161.6	158.1/152.8	175/175	144/163	158/176	402/402	162.8/152.8	175/175	150/168	387/387	177.5/167.6	200/175	163/182	407/407
575-3-60	460-3-60	UL- TRA HIGH	NONE	-	-	-	79.7	100	84	456	476	84.5	100	89	461	96.3	96.3	110	481		
			302/305A00	11.3/15.0	31.3/36.1	31.3/36.1	456/456	91.5/94.9	91.5/94.9	100/100	84/84	476/476	97/97	84.5/86.1	100/100	89/89	461/461	96.3/100.9	103/103	481/481	
			279/270A00	18.8/25.0	52.1/60.1	52.1/60.1	456/456	114.9/124.9	106.1/116.1	114.9/130.9	92/101	476/476	106/115	106.1/116.1	110/125	98/107	461/461	120.9/130.9	111/120	481/481	
			309/312A00	37.6/50.0	104.2/120.3	104.2/120.3	456/456	180.0/170.1	171.3/161.3	200/175	152/171	476/476	166/184	171.3/161.3	175/175	158/176	461/461	186.0/176.1	200/200	171/190	481/481
		STD	NONE	-	-	-	-	-	31.3	40	33	167	179	33.5	40	35	169	39.7	39.7	50	181
			303/306A00	15.0	18.0	18.0	167	37.5	37.5	45	33	167	40	33.5	40	35	169	39.7	39.7	50	181
			282/273A00	25.0	30.1	30.1	167	50.1	50.1	60	39	167	46	45.1	50	42	169	52.9	52.9	60	181
			310/313A00	50.0	60.1	60.1	167	72.6	72.6	80	70	73	81	67.6	80	76	169	75.4	75.4	80	181
		MED	NONE	-	-	-	-	-	33.9	45	36	184	196	36.1	45	38	186	42.3	42.3	50	198
			303/306A00	15.0	18.0	18.0	184	40.1	40.1	50	36	184	43	36.1	45	38	186	42.3	42.3	50	198
			282/273A00	25.0	30.1	30.1	184	53.4	53.4	60	42	184	49	48.4	50	46	186	56.1	56.1	60	198
			310/313A00	50.0	60.1	60.1	184	75.9	75.9	80	76	184	84	70.9	80	79	186	78.6	78.6	80	198
HIGH	NONE	-	-	-	-	-	37.2	45	40	186	198	39.4	45	42	188	45.6	45.6	50	200		
	303/306A00	15.0	18.0	18.0	186	43.4	43.4	50	40	186	47	39.4	45	42	188	45.6	45.6	50	200		
	282/273A00	25.0	30.1	30.1	186	57.5	57.5	60	46	186	53	52.5	60	48	188	60.3	60.3	70	200		
	310/313A00	50.0	60.1	60.1	186	80.0	80.0	90	80	186	87	75.0	80	83	188	82.7	82.7	90	200		
UL- TRA HIGH	NONE	-	-	-	-	-	41.8	50	44	223	235	44.0	50	47	225	50.2	50.2	60	237		
	303/306A00	15.0	18.0	18.0	223	48.0	48.0	60	44	223	51	44.0	50	47	225	50.2	50.2	60	237		
	282/273A00	25.0	30.1	30.1	223	62.5	62.5	70	58	223	58	57.5	60	53	225	65.3	65.3	70	237		
	310/313A00	50.0	60.1	60.1	223	85.0	85.0	90	85	223	92	80.0	90	87	225	87.7	87.7	90	237		
STD	NONE	-	-	-	-	-	24.4	30	26	119	127	26.1	30	28	121	30.9	30.9	35	129		
	304/307A00	15.0	14.4	14.4	119	29.6	29.6	35	26	119	31	26.1	30	28	121	31.8	31.8	35	129		
	285/276A00	24.8	23.9	23.9	119	41.5	41.5	45	33	119	38	37.6	40	35	121	43.6	43.6	45	129		
	311/314A00	49.6	47.7	47.7	119	65.3	65.3	70	60	119	66	61.3	70	62	121	67.4	67.4	80	129		
MED	NONE	-	-	-	-	-	26.1	30	28	133	141	27.8	30	30	135	32.6	32.6	40	143		
	304/307A00	15.0	14.4	14.4	133	31.8	31.8	35	28	133	33	27.8	30	30	135	33.9	33.9	40	143		
	285/276A00	24.8	23.9	23.9	133	43.6	43.6	45	40	133	37	41.5	40	37	141	45.8	45.8	50	143		
	311/314A00	49.6	47.7	47.7	133	73.4	73.4	80	68	133	68	69.5	70	64	135	75.5	75.5	80	143		
HIGH	NONE	-	-	-	-	-	27.1	30	29	131	139	28.8	35	31	133	33.6	33.6	40	141		
	304/307A00	15.0	14.4	14.4	131	33.0	33.0	35	29	131	34	29.1	35	31	133	35.1	35.1	40	141		
	285/276A00	24.8	23.9	23.9	131	44.9	44.9	45	41	131	38	41.0	45	41	133	43.0	43.0	50	141		
	311/314A00	49.6	47.7	47.7	131	74.6	74.6	80	69	131	69	70.8	80	65	133	76.8	76.8	80	141		
UL- TRA HIGH	NONE	-	-	-	-	-	29.0	35	31	158	166	30.7	35	33	160	35.5	35.5	40	168		
	304/307A00	15.0	14.4	14.4	158	35.1	35.1	40	36	158	36	30.7	35	33	160	33.3	33.3	40	168		
	285/276A00	24.8	23.9	23.9	158	47.0	47.0	50	43	158	43	43.1	45	45	160	49.1	49.1	50	168		
	311/314A00	49.6	47.7	47.7	158	76.8	76.8	80	65	158	71	72.9	80	67	160	78.9	78.9	80	168		

See Legend and Notes on page 74

ELECTRICAL DATA (cont.)

Table 45 (cont.) - UNIT WIRE/FUSE OR HACR BREAKER SIZING DATA

UNIT	NO M, V-PH-HZ	ELEC. HTR				NO C.O. or UNPWR C.O.						w/ PWRD C.O.					
		CRHEATER***A00 VERT/HORZ	Nom (kW)	FLA	NO P.E.			w/ P.E. (pwrd frimnt)			NO P.E.			w/ P.E. (pwrd frimnt)			
					MCA	MAX FUSE or HACR BRKR	DISC. SIZE FLA LRA	MCA	MAX FUSE or HACR BRKR	DISC. SIZE FLA LRA	MCA	MAX FUSE or HACR BRKR	DISC. SIZE FLA LRA	MCA	MAX FUSE or HACR BRKR	DISC. SIZE FLA LRA	
STD		NONE	18.8/25.0	-	7069	371	8382	391	72,271.4	90/90	75/74	376	84,083.2	100/100	89/88	396	
		279/270A00	18.8/25.0	52.1/60.1	7078	371/371	83/92	391/391	81,990.6	90/100	75/84	376/376	96,6105.6	100/110	89/97	396/396	
		280/271A00	37.6/50.0	104.2/120.3	1300/17	371/371	143/161	391/391	147,0136.1	150/150	135/153	376/376	161,8150.8	175/175	149/166	396/396	
		281/272A00	56.3/75.0	156.4/180.4	1902/216	371/371	203/230	391/391	173.2/196.2	200/225	195/222	376/376	187,9210.9	200/225	209/236	396/396	
MED	208/230-3-60	NONE	18.8/25.0	-	84	410	98	91.8	100	84.8	90	415	96.6	110	103	435	
		279/270A00	18.8/25.0	52.1/60.1	84/93	410/410	98/107	430/430	97.6/107.6	100/110	90/99	415/415	112.4/122.4	125/125	103/113	435/435	
		280/271A00	37.6/50.0	104.2/120.3	144/163	410/410	158/176	430/430	162.8/152.8	175/175	150/168	415/415	177.5/167.6	200/175	163/182	435/435	
		281/272A00	56.3/75.0	156.4/180.4	204/232	410/410	218/245	430/430	188.9/212.9	200/250	210/237	415/415	203.7/227.7	225/250	223/251	435/435	
HIGH	208/230-3-60	NONE	18.8/25.0	-	92	484	105	98.7	125	91.7	105	504	103.5	125	111	509	
		279/270A00	18.8/25.0	52.1/60.1	92/101	484/484	106/115	504/504	106.1/116.1	110/125	98/107	489/489	120.9/130.9	125/150	111/120	509/509	
		280/271A00	37.6/50.0	104.2/120.3	152/171	484/484	166/184	504/504	171.3/161.3	200/200	158/176	489/489	186.0/176.1	200/200	171/190	509/509	
		281/272A00	56.3/75.0	156.4/180.4	212/240	484/484	226/253	504/504	197.4/221.4	225/250	218/245	489/489	212.2/236.2	225/250	231/259	509/509	
ULTRA HIGH	208/230-3-60	NONE	18.8/25.0	-	103	524	116	110.3	125	103.3	108	529	115.1	150	122	549	
		279/270A00	18.8/25.0	52.1/60.1	103/112	524/524	116/126	544/544	117.8/127.8	125/150	108/118	529/529	132.5/142.5	150/150	122/131	549/549	
		280/271A00	37.6/50.0	104.2/120.3	163/181	524/524	176/195	544/544	182.9/172.9	200/200	168/187	529/529	197.6/187.7	200/200	182/200	549/549	
		281/272A00	56.3/75.0	156.4/180.4	223/250	524/524	236/264	544/544	209.0/233.0	225/250	228/256	529/529	223.8/247.8	250/300	242/269	549/549	
STD	460-3-60	NONE	25.0	30.1	36	193	43	41.0	50	37.0	45	195	43.2	50	46	207	
		282/273A00	25.0	30.1	39	193	46	46	50.1	60	45.1	50	52.9	60	49	207	
		283/274A00	50.0	60.1	73	193	81	205	72.6	80	67.6	80	75.4	80	83	207	
		284/275A00	75.0	90.2	108	193	115	205	102.7	110	97.7	100	105.5	110	118	207	
MED	460-3-60	NONE	25.0	-	43	212	42	46.9	60	42.9	50	224	49.1	60	53	226	
		282/273A00	25.0	30.1	46	212	53	57.5	60	52.5	60	60	60.3	70	55	226	
		283/274A00	50.0	60.1	80	212	87	224	75.0	80	82.7	88	82.7	90	90	226	
		284/275A00	75.0	90.2	115	212	122	224	105.1	125	117	117	112.8	125	125	226	
HIGH	460-3-60	NONE	25.0	-	48	249	55	51.1	60	47.1	60	251	53.3	60	57	263	
		282/273A00	25.0	30.1	50	249	58	62.5	70	57.5	60	251	65.3	70	60	263	
		283/274A00	50.0	60.1	85	249	92	261	80.0	90	80.0	87	87.7	90	95	263	
		284/275A00	75.0	90.2	119	249	127	261	115.1	125	122	122	117.8	125	129	263	
ULTRA HIGH	460-3-60	NONE	25.0	-	51	269	59	55.1	60	51.1	60	281	57.3	70	61	283	
		282/273A00	25.0	30.1	54	269	61	66.5	70	61.5	60	281	69.3	70	64	283	
		283/274A00	50.0	60.1	89	269	96	281	84.0	100	84.0	100	91.7	100	98	283	
		284/275A00	75.0	90.2	123	269	130	281	114.1	125	126	271	121.8	125	133	283	
STD	575-3-60	NONE	24.8	-	32	154	37	34.8	40	31.7	40	162	36.5	45	39	164	
		285/276A00	24.8	23.9	33	154	38	41.5	45	37.6	40	162	43.6	45	40	164	
		286/277A00	49.6	47.7	60	154	66	71.3	67.4	70	67.4	62	73.4	80	68	164	
		281/278A00	74.4	71.6	88	154	93	83.2	79.4	90	85.4	90	85.4	90	95	164	
MED	575-3-60	NONE	24.8	-	35	166	40	37.5	45	34.4	40	174	39.2	45	42	176	
		285/276A00	24.8	23.9	36	166	41	44.9	45	41.0	45	168	47.0	50	43	176	
		286/277A00	49.6	47.7	63	166	69	74.6	70.8	80	76.8	65	76.8	80	71	176	
		281/278A00	74.4	71.6	91	166	96	82.7	86.6	90	82.7	90	88.7	90	98	176	
HIGH	575-3-60	NONE	24.8	-	37	193	42	39.2	45	36.1	45	201	40.9	50	44	203	
		285/276A00	24.8	23.9	38	193	43	47.0	50	43.1	45	201	49.1	50	45	203	
		286/277A00	49.6	47.7	65	193	71	70.8	72.9	80	78.9	67	78.9	80	73	203	
		281/278A00	74.4	71.6	93	193	98	88.7	88.7	90	84.9	95	90.9	100	100	203	
ULTRA HIGH	575-3-60	NONE	24.8	-	41	204	46	43.5	50	40.4	50	212	45.2	50	48	214	
		285/276A00	24.8	23.9	42	204	47	51.6	50	47.8	50	214	53.8	60	49	214	
		286/277A00	49.6	47.7	69	204	75	81.4	77.5	80	77.5	71	83.5	90	77	214	
		281/278A00	74.4	71.6	97	204	102	93.4	89.5	100	89.5	99	95.5	100	104	214	

See Legend and Notes on page 74

ELECTRICAL DATA (cont.)

Table 45 (cont.) - UNIT WIRE/FUSE OR HACR BREAKER SIZING DATA

UNIT	NO M, V-PH-HZ	ELEC. HTR				NO C.O. or UNPWR C.O.								w/ PWRD C.O.								
		CR/HEATER***A00 VERT/HORZ	Nom (kW)	FLA		NO P.E.		w/ P.E. (pwrd fruntit)		NO P.E.		w/ P.E. (pwrd fruntit)		NO P.E.		w/ P.E. (pwrd fruntit)						
						MAX FUSE or HACR BRKR	DISC. SIZE FLA LRA	MCA	MAX FUSE or HACR BRKR	MCA	MAX FUSE or HACR BRKR	DISC. SIZE FLA LRA	MCA	MAX FUSE or HACR BRKR	MCA	MAX FUSE or HACR BRKR	DISC. SIZE FLA LRA	MCA	MAX FUSE or HACR BRKR	DISC. SIZE FLA LRA		
STD		NONE	18.9/25.0	52.1/60.1	73.3/72.5	100/100	76/75	412	85.1/84.3	100/100	90/89	432	78.1/77.3	100/100	82/81	89.9/89.1	100/100	82/81	89.9/89.1	100/100	95/95	
		279/270A00	18.9/25.0	52.1/60.1	75.9/84.9	100/100	76/78	412/412	90.6/99.6	100/100	90/92	432/432	81.9/90.9	100/100	82/84	96.6/105.6	100/110	82/84	96.6/105.6	100/110	95/97	
		280/271A00	37.6/50.0	104.2/120.3	141.0/130.1	150/150	130/147	412/412	155.8/144.8	175/150	143/161	432/432	147.0/136.1	150/150	135/153	161.8/150.8	200/225	135/153	161.8/150.8	200/225	149/166	
		281/272A00	56.3/75.0	156.4/180.4	167.2/190.2	200/200	190/216	412/412	181.9/204.9	200/225	203/230	432/432	173.2/196.2	200/225	195/222	187.9/210.9	200/225	195/222	187.9/210.9	200/225	209/236	
MED	208/230-3-60	NONE	18.9/25.0	52.1/60.1	85.9	100	91	451	97.7	125	104	471	90.7	100	102.5	125	96	102.5	125	110	476	
		279/270A00	18.9/25.0	52.1/60.1	91.6/101.6	100/110	91/93	451/451	106.4/116.4	125/125	104/107	471/471	97.6/107.6	100/110	96/99	112.4/122.4	125/125	96/99	112.4/122.4	125/125	110/113	
		280/271A00	37.6/50.0	104.2/120.3	156.8/146.8	175/175	144/163	451/451	171.5/161.6	175/175	158/176	471/471	162.8/152.8	175/175	150/168	177.5/167.6	200/175	150/168	177.5/167.6	200/175	163/182	
		281/272A00	56.3/75.0	156.4/180.4	182.9/206.9	200/250	204/232	451/451	197.7/217.7	225/250	218/245	471/471	188.9/212.9	200/250	210/237	203.7/227.7	225/250	210/237	203.7/227.7	225/250	223/251	
HIGH	208/230-3-60	NONE	18.9/25.0	52.1/60.1	92.8	100	99	525	104.6	125	112	545	97.6	125	109.4	125	104	109.4	125	118	550	
		279/270A00	18.9/25.0	52.1/60.1	100.1/110.1	110/125	99/101	525/525	114.9/124.9	125/125	112/115	545/545	106.1/116.1	125/125	104/107	120.9/130.9	125/150	104/107	120.9/130.9	125/150	118/120	
		280/271A00	37.6/50.0	104.2/120.3	165.3/155.3	175/175	152/171	525/525	180.0/170.1	200/200	169/184	545/545	171.3/161.3	200/200	158/176	186.0/176.1	200/200	158/176	186.0/176.1	200/200	171/190	
		281/272A00	56.3/75.0	156.4/180.4	191.4/215.4	200/250	212/240	525/525	206.2/230.2	225/250	226/253	545/545	197.4/221.4	225/250	218/245	212.2/236.2	225/250	218/245	212.2/236.2	225/250	231/259	
ULTRA HIGH	50LC**20	NONE	18.9/25.0	52.1/60.1	104.4	125	109	565	116.2	150	123	585	109.2	125	121.0	150	115	121.0	150	128	590	
		279/270A00	18.9/25.0	52.1/60.1	111.8/121.8	125/125	109/112	565/565	126.5/136.5	150/150	123/126	585/585	117.8/127.8	125/150	115/118	132.5/142.5	150/150	115/118	132.5/142.5	150/150	128/131	
		280/271A00	37.6/50.0	104.2/120.3	176.9/166.9	200/200	163/181	565/565	191.6/181.7	200/200	176/195	585/585	182.9/172.9	200/200	168/187	197.6/187.7	200/200	168/187	197.6/187.7	200/200	182/200	
		281/272A00	56.3/75.0	156.4/180.4	203.0/227.0	225/250	223/250	565/565	217.8/241.8	250/250	236/264	585/585	209.0/233.0	225/250	228/256	223.8/247.8	250/300	228/256	223.8/247.8	250/300	242/269	
STD	460-3-60	NONE	25.0	30.1	37.2	50	39	231	43.4	50	46	243	39.4	50	45.6	50	42	45.6	50	49	245	
		282/273A00	25.0	30.1	42.4	50	39	231	50.1	60	46	243	45.1	50	52.9	60	42	52.9	60	49	245	
		283/274A00	50.0	60.1	64.9	70	73	231	72.6	80	81	243	67.6	80	76	75.4	80	76	75.4	80	83	245
		284/275A00	75.0	90.2	95.0	100	108	231	102.7	110	115	243	97.7	100	111	105.5	110	111	105.5	110	118	
MED	460-3-60	NONE	25.0	30.1	43.1	50	46	250	49.3	60	53	262	45.3	50	51.5	60	48	51.5	60	56	264	
		282/273A00	25.0	30.1	49.8	50	46	250	57.5	60	53	262	52.5	60	48	60.3	70	52.5	60.3	70	56	
		283/274A00	50.0	60.1	72.2	80	80	250	80.0	90	87	262	75.0	80	83	82.7	90	83	82.7	90	90	
		284/275A00	75.0	90.2	102.3	125	115	250	110.1	125	122	262	105.1	125	117	112.8	125	117	112.8	125	125	
HIGH	460-3-60	NONE	25.0	30.1	47.3	60	50	287	53.5	60	58	299	49.5	60	55.7	60	53	55.7	60	60	301	
		282/273A00	25.0	30.1	54.8	60	50	287	62.5	70	58	299	57.5	60	53	65.3	70	53	65.3	70	60	
		283/274A00	50.0	60.1	77.2	90	85	287	85.0	90	92	299	80.0	90	87	87.7	90	87	87.7	90	95	
		284/275A00	75.0	90.2	107.3	125	119	287	115.1	125	127	299	110.1	125	122	117.8	125	122	117.8	125	129	
ULTRA HIGH	460-3-60	NONE	25.0	30.1	51.3	60	54	307	57.5	70	61	319	53.5	60	59.7	70	57	59.7	70	64	321	
		282/273A00	25.0	30.1	58.8	60	54	307	66.5	70	61	319	61.5	60	57	69.3	70	57	69.3	70	64	
		283/274A00	50.0	60.1	81.2	90	89	307	89.0	100	96	319	84.0	100	91	91.7	100	91	91.7	100	98	
		284/275A00	75.0	90.2	111.3	125	123	307	119.1	125	130	319	114.1	125	126	121.8	125	126	121.8	125	133	
STD	575-3-60	NONE	24.8	23.9	31.8	40	34	182	36.6	45	39	190	33.5	40	38.3	45	36	38.3	45	41	192	
		285/276A00	24.8	23.9	35.5	40	34	182	41.5	45	39	190	37.6	40	40	43.6	45	36	43.6	45	41	
		286/277A00	49.6	47.7	65.3	70	60	182	71.3	80	66	190	67.4	70	62	73.4	80	62	73.4	80	68	
		287/278A00	74.4	71.6	77.2	90	88	182	83.2	90	93	190	79.4	80	93	85.4	90	93	85.4	90	95	
MED	575-3-60	NONE	24.8	23.9	34.5	40	37	194	39.3	45	42	202	36.2	45	41.0	50	39	41.0	50	44	204	
		285/276A00	24.8	23.9	38.9	40	37	194	44.9	45	42	202	41.0	45	39	47.0	50	39	47.0	50	44	
		286/277A00	49.6	47.7	68.6	70	63	194	74.6	80	69	202	70.8	80	65	76.8	90	65	76.8	90	71	
		287/278A00	74.4	71.6	80.6	90	91	194	86.6	90	96	202	82.7	90	96	88.7	90	96	88.7	90	98	
HIGH	575-3-60	NONE	24.8	23.9	36.2	45	39	221	41.0	50	44	229	37.9	45	42.7	50	41	42.7	50	46	231	
		285/276A00	24.8	23.9	41.0	45	39	221	47.0	50	44	229	43.1	45	41	49.1	50	41	49.1	50	46	
		286/277A00	49.6	47.7	70.8	80	65	221	76.8	80	71	229	72.9	80	67	78.9	80	67	78.9	80	73	
		287/278A00	74.4	71.6	82.7	90	93	221	88.7	90	98	229	84.9	90	95	90.9	100	95	90.9	100	100	
ULTRA HIGH	575-3-60	NONE	24.8	23.9	40.5	50	43	232	45.3	50	48	240	42.2	50	47.0	60	45	47.0	60	50	242	
		285/276A00	24.8	23.9	45.6	50	43	232	51.6	60	48	240	47.8	50	45	53.8	60	45	53.8	60	50	
		286/277A00	49.6	47.7	75.4	80	69	232	81.4	90	75	240	77.5	80	71	83.5	90	71	83.5	90	77	
		287/278A00	74.4	71.6	87.4	100	97	232	93.4	100	102	240	89.5	100	99	95.5	100	99	95.5	100	104	

See Legend and Notes on page 74

ELECTRICAL DATA (cont.)

Table 45 (cont.) - UNIT WIRE/FUSE OR HACR BREAKER SIZING DATA

UNIT	IFM TYPE	ELEC. HTR			NO C.O. or UNPWR C.O.						w/ PWRD C.O.						
		CRHEATER**A00 VERT/HORZ	Nom (kW)	FLA	NO P.E.			w/ P.E. (pwrd fr/unit)			NO P.E.			w/ P.E. (pwrd fr/unit)			
					MCA	MAX FUSE or HACR BRKR	DISC. SIZE FLA LRA	MCA	MAX FUSE or HACR BRKR	DISC. SIZE FLA LRA	MCA	MAX FUSE or HACR BRKR	DISC. SIZE FLA LRA	MCA	MAX FUSE or HACR BRKR	DISC. SIZE FLA LRA	
208/230-3-60	STD	NONE	-	-	129	629	142	649	129.7	175	134	634	141.5	175	148	654	
		279/270A00	18.8/25.0	52.1/60.1	124.9/124.9	629/629	142/142	649/649	129.7/129.7	175/175	134/134	634/634	141.5/141.5	175/175	148/148	654/654	
		280/271A00	37.6/50.0	104.2/120.3	156.8/146.8	1447/63	629/629	158/176	649/649	162.8/152.8	175/175	150/168	634/634	177.5/167.6	200/175	163/182	654/654
208/230-3-60	MED	NONE	-	-	204/232	629/629	218/245	649/649	188.9/212.9	225/250	210/237	634/634	203.7/227.7	225/250	223/251	654/654	
		279/270A00	18.8/25.0	52.1/60.1	131.7	703	150	723	136.5	175	142	708	148.3	175	156	728	
		280/271A00	37.6/50.0	104.2/120.3	165.3/155.3	703/703	150/150	166/184	723/723	171.3/161.3	175/175	142/142	708/708	148.3/148.3	175/175	156/156	728/728
208/230-3-60	HIGH	NONE	-	-	212/240	703/703	226/253	723/723	197.4/221.4	225/250	218/245	708/708	212.2/236.2	225/250	231/259	728/728	
		279/270A00	18.8/25.0	52.1/60.1	141.0/141.0	743/743	161	763	145.8	200	153	748	157.6	200	167	768	
		280/271A00	37.6/50.0	104.2/120.3	176.9/166.9	743/743	161/161	763/763	145.8/145.8	200/200	153/153	748/748	157.6/157.6	200/200	167/167	768/768	
460-3-60	STD	NONE	-	-	322	322	75	334	67.1	90	70	324	73.3	90	78	336	
		282/273A00	25.0	30.1	64.9	322	322	75	334	67.1	90	70	324	73.3	90	78	336
		283/274A00	50.0	60.1	72.2	322	322	87	334	75.0	90	83	324	82.7	90	90	336
460-3-60	MED	NONE	-	-	115	322	122	334	105.1	125	117	324	112.8	125	125	336	
		282/273A00	25.0	30.1	68.9	359	359	80	371	71.1	90	75	361	77.3	100	82	373
		283/274A00	50.0	60.1	77.2	359	359	92	371	80.0	90	87	361	87.7	100	95	373
575-3-60	HIGH	NONE	-	-	119	359	127	371	110.1	125	122	361	117.8	125	129	373	
		282/273A00	25.0	30.1	72.1	379	379	83	391	74.3	90	79	381	80.5	100	86	393
		283/274A00	50.0	60.1	81.2	379	379	96	391	84.0	100	91	381	91.7	100	98	393
575-3-60	STD	NONE	-	-	123	379	130	391	114.1	125	126	381	121.8	125	133	393	
		285/276A00	24.8	23.9	53.9	235	235	62	243	55.6	70	58	237	60.4	80	64	245
		286/277A00	49.6	47.7	68.6	235	235	69	243	70.8	80	65	237	76.8	80	71	245
575-3-60	MED	NONE	-	-	91	235	96	243	82.7	90	93	237	88.7	90	98	245	
		285/276A00	24.8	23.9	55.6	262	262	64	270	57.3	70	60	264	62.1	80	66	272
		286/277A00	49.6	47.7	70.8	262	262	71	270	72.9	80	67	264	78.9	80	73	272
575-3-60	HIGH	NONE	-	-	97	273	98	270	84.9	90	95	264	90.9	100	100	272	
		285/276A00	24.8	23.9	59.3	273	273	68	281	61.0	80	64	275	65.8	80	70	283
		286/277A00	49.6	47.7	75.4	273	273	75	281	77.5	80	71	275	83.5	90	77	283

See Legend and Notes on page 74

ELECTRICAL DATA (cont.)

Table 46 (cont.) - UNIT WIRE SIZING DATA WITH FACTORY-INSTALLED HACR BREAKER

UNIT	IFM TYPE	ELEC. HTR			NO C.O. or UNPWR C.O.						w/ PWRD C.O.										
		CR/HEATER**A00 VERT/HORZ	Nom (kW)	FLA	NO P.E.			w/ P.E. (pwrd frnt/nt)			NO P.E.			w/ P.E. (pwrd frnt/nt)							
					HACR BRKR	DISC. SIZE FLA LRA	MCA	HACR BRKR	MCA	DISC. SIZE FLA LRA	HACR BRKR	MCA	DISC. SIZE FLA LRA	HACR BRKR	MCA	DISC. SIZE FLA LRA					
50LC**17	STD	NONE	18.8/25.0	52.1/60.1	7069	371	79.2/79.2	100/100	8382	391	72.2/72.2	90/90	75/74	84.0/84.0	100/100	89/88	396				
					7078	371/371	99.6/99.6	100/100	8392	391/391	90.9/90.9	100/100	83/82	376/376	90/90	75/74	105.6/105.6	110/110	89/87	396/396	
					130147	371/371	155.8/155.8	150/150	130147	371/371	143.1/143.1	150/150	135/153	376/376	150/150	135/153	161.8/161.8	175/175	149/166	396/396	
					190216	371/371	204.9/204.9	200/200	190216	371/371	203.2/30	200/225	195/222	376/376	200/225	200/225	210.9/210.9	225/225	209/236	396/396	
					84	410	91.8	100	98	430	84.8	100	90	415	110	110	96.6	110	103	435	
					101.6/101.6	410/410	116.4/116.4	125/125	98/107	430/430	107.6/107.6	125/125	90/99	415/415	122.4/122.4	125/125	122.4/122.4	125/125	103/113	435/435	
	MED	208/230-3-60	NONE	18.8/25.0	52.1/60.1	144763	410/410	171.5/171.5	175/175	158/176	430/430	162.8/162.8	175/175	150/168	177.5/177.5	200/200	163/182	435/435			
						204232	410/410	221.7/221.7	225/250	218/245	430/430	212.9/212.9	225/250	210/237	225/250	223/251	223/251	435/435			
						86.9	484	98.7	125	105	504	91.7	100	97	489	125	111	103.5	125	111	509
						110.1/110.1	484/484	124.9/124.9	125/125	106/115	504/504	116.1/116.1	125/125	98/107	489/489	130.9/130.9	150/150	111/120	150/150	111/120	509/509
						165.3/165.3	484/484	180.0/180.0	200/200	166/184	504/504	171.3/171.3	175/175	158/176	489/489	186.0/186.0	200/200	171/190	200/200	171/190	509/509
						215.4/215.4	484/484	230.2/230.2	250/250	218/245	504/504	221.4/221.4	225/250	218/245	489/489	236.2/236.2	250/250	218/245	250/250	231/259	509/509
ULTRA HIGH	208/230-3-60	NONE	18.8/25.0	52.1/60.1	103112	524	110.3	125	116	544	103.3	125	108	115.1	150	122	549				
					163181	524/524	191.6/191.6	200/200	176/195	544/544	182.9/182.9	200/200	168/187	529/529	200/200	182/200	200/200	182/200	549/549		
					223250	524/524	241.8/241.8	250/250	236/264	544/544	233.0/233.0	250/250	228/256	529/529	250/250	228/256	247.8/247.8	250/300	242/269	549/549	
					36	193	41.0	50	43	205	37.0	45	39	195	50	46	43.2	50	46	207	
					42.4	193	50.1	60	46	205	45.1	50	42	195	50	46	52.9	60	49	207	
					64.9	193	72.6	80	76	205	67.6	80	76	195	80	76	82.7	80	83	207	
STD	460-3-60	NONE	25.0	60.1	108	193	102.7	110	115	205	97.7	100	111	105.5	110	118	207				
					40.7	212	46.9	60	50	224	42.9	50	46	214	60	53	226				
					49.8	212	57.5	60	53	224	52.5	60	48	214	60	55	226				
					72.2	212	80.0	90	87	224	75.0	90	83	214	90	90	226				
					102.3	212	110.1	125	122	224	105.1	125	117	214	125	125	226				
					44.9	249	51.1	60	55	261	47.1	60	50	251	60	57	263				
MED	460-3-60	NONE	25.0	30.1	50	249	62.5	70	58	261	57.5	60	53	65.3	70	60	263				
					54.8	249	85.0	90	87	261	80.0	90	87	251	90	95	263				
					77.2	249	115.1	125	127	261	110.1	125	125	251	125	129	263				
					107.3	249	151.1	150	149	261	149.1	150	149	251	150	149	263				
					48.9	269	55.1	60	59	281	51.1	60	54	271	60	61	283				
					58.8	269	66.5	70	61	281	61.5	70	57	271	70	64	283				
HIGH	460-3-60	NONE	50.0	60.1	89	269	89.0	100	96	281	84.0	100	91	91.7	100	98	283				
					111.3	269	119.1	125	130	281	114.1	125	126	271	125	133	283				
					30.0	154	34.8	40	37	162	31.7	40	33	156	45	39	164				
					23.9	154	41.5	45	38	162	37.6	45	35	162	45	40	164				
					47.7	154	67.4	70	66	162	61.4	70	62	156	80	68	164				
					71.6	154	83.2	90	93	162	79.4	90	89	156	90	95	164				
STD	575-3-60	NONE	24.8	23.9	35	166	37.5	45	40	174	34.4	40	37	39.2	45	42	176				
					38.9	166	44.9	45	41	174	41.0	45	38	168	45	43	176				
					68.6	166	74.6	80	69	174	70.8	80	65	168	80	71	176				
					80.6	166	86.6	90	96	174	82.7	90	93	168	90	98	176				
					34.4	193	39.2	45	42	201	36.1	45	39	195	45	44	203				
					41.0	193	47.0	50	43	201	43.1	50	40	195	50	45	203				
MED	575-3-60	NONE	49.6	47.7	65	193	76.8	80	71	201	72.9	80	67	73.9	80	73	203				
					82.7	193	88.7	90	98	201	84.9	90	95	195	100	100	203				
					38.7	204	43.5	50	46	212	40.4	50	43	206	45	48	214				
					45.6	204	51.6	60	47	212	47.8	60	44	206	60	49	214				
					75.4	204	81.4	90	75	212	77.5	90	71	206	90	77	214				
					87.4	204	93.4	100	97	212	89.5	100	99	206	100	104	214				

See Legend and Notes on page 74

ELECTRICAL DATA (cont.)

Table 46 (cont.) - UNIT WIRE SIZING DATA WITH FACTORY-INSTALLED HACR BREAKER

UNIT	IFM TYPE	ELEC. HTR			NO C.O. or UNPWR C.O.						w/ PWRD C.O.									
		CR/HEATER**A00 VERT/HORZ	Nom (kW)	FLA	NO P.E.			w/ P.E. (pwrd frtunit)			NO P.E.			w/ P.E. (pwrd frtunit)						
					MCA	HACR BRKR	DISC. SIZE FLA LRA	MCA	HACR BRKR	DISC. SIZE FLA LRA	MCA	HACR BRKR	DISC. SIZE FLA LRA	MCA	HACR BRKR	DISC. SIZE FLA LRA				
50LC**20	STD	NONE	18.8/25.0	52.1/60.1	73.3/73.3	100/100	76/75	412	85.1/85.1	100/100	90/89	432	78.1/78.1	100/100	82/81	417	89.9/89.9	100/100	95/95	437
		2792/70A00	37.6/50.0	104.2/120.3	84.9/84.9	100/100	76/78	412/412	99.6/99.6	100/100	90/92	432/432	90.9/90.9	100/100	82/84	417/417	105.6/105.6	110/110	95/97	437/437
		2802/71A00	56.3/75.0	156.4/180.4	141.0/141.0	200/200	130/147	412/412	155.8/155.8	150/150	143/161	432/432	147.0/147.0	150/150	135/153	417/417	161.8/161.8	175/175	149/166	437/437
208/230-3-60	MED	NONE	18.8/25.0	52.1/60.1	85.9	100	91	451	97.7	125	104	471	90.7	100	96	456	102.5	125	110	476
		2792/70A00	37.6/50.0	104.2/120.3	101.6/101.6	110/110	91/93	451/451	116.4/116.4	125/125	104/107	471/471	107.6/107.6	110/110	96/99	456/456	122.4/122.4	125/125	110/113	476/476
		2802/71A00	56.3/75.0	156.4/180.4	156.9/206.9	225/250	144/163	451/451	171.5/171.5	175/175	158/176	471/471	162.8/162.8	175/175	150/168	456/456	177.5/177.5	200/200	163/182	476/476
208/230-3-60	HIGH	NONE	18.8/25.0	52.1/60.1	92.8	100	99	525	104.6	125	112	545	97.6	125	104	530	109.4	125	118	550
		2792/70A00	37.6/50.0	104.2/120.3	110.1/110.1	125/125	99/101	525/525	124.9/124.9	125/125	112/115	545/545	116.1/116.1	125/125	104/107	530/530	130.9/130.9	150/150	118/120	550/550
		2802/71A00	56.3/75.0	156.4/180.4	165.3/165.3	225/250	152/171	525/525	180.0/180.0	200/200	166/184	545/545	171.3/171.3	175/175	158/176	530/530	186.0/186.0	200/200	171/190	550/550
460-3-60	ULTRA HIGH	NONE	18.8/25.0	52.1/60.1	104.4	125	109	565	116.2	150	123	585	109.2	125	115	570	121.0	150	128	590
		2792/70A00	37.6/50.0	104.2/120.3	121.8/121.8	200/200	109/112	565/565	136.5/136.5	150/150	123/126	585/585	127.8/127.8	150/150	115/118	570/570	142.5/142.5	150/150	128/131	590/590
		2802/71A00	56.3/75.0	156.4/180.4	227.0/227.0	250/250	163/181	565/565	191.6/191.6	200/200	176/195	585/585	182.9/182.9	200/200	168/187	570/570	197.6/197.6	200/200	182/200	590/590
460-3-60	STD	NONE	25.0	30.1	37.2	50	39	231	43.4	50	46	243	39.4	50	42	233	45.6	50	49	245
		2832/74A00	50.0	60.1	42.4	50	33	231	72.6	60	46	243	45.1	50	42	233	52.9	60	49	245
		2842/75A00	75.0	90.2	95.0	100	108	231	102.7	110	115	243	97.7	100	111	233	105.5	110	118	245
575-3-60	MED	NONE	25.0	30.1	43.1	50	46	250	49.3	60	53	262	45.3	50	48	252	51.5	60	56	264
		2832/74A00	50.0	60.1	49.8	50	46	250	57.5	60	53	262	52.5	60	48	252	60.3	70	56	264
		2842/75A00	75.0	90.2	72.2	80	80	250	80.0	90	87	262	75.0	80	83	252	82.7	90	90	264
575-3-60	HIGH	NONE	25.0	30.1	47.3	50	47	287	53.5	60	58	299	49.5	60	53	289	55.7	60	60	301
		2832/74A00	50.0	60.1	54.8	60	50	287	62.5	70	58	299	57.5	60	53	289	65.3	70	60	301
		2842/75A00	75.0	90.2	77.2	90	85	287	85.0	90	92	299	80.0	90	87	289	87.7	90	95	301
575-3-60	ULTRA HIGH	NONE	25.0	30.1	51.3	60	54	307	57.5	70	61	319	53.5	60	57	309	59.7	70	64	321
		2832/74A00	50.0	60.1	58.8	60	54	307	66.5	70	61	319	61.5	60	57	309	69.3	70	64	321
		2842/75A00	75.0	90.2	111.3	125	123	307	119.1	125	130	319	114.1	125	126	309	121.8	125	133	321
575-3-60	STD	NONE	24.8	23.9	31.8	40	34	182	36.6	45	39	190	33.5	40	36	184	38.3	45	41	192
		2852/76A00	49.6	47.7	47.7	60	60	182	71.3	80	66	190	67.4	70	62	184	73.4	80	68	192
		2862/77A00	74.4	71.6	77.2	90	88	182	83.2	90	93	190	79.4	80	89	184	85.4	90	95	192
575-3-60	MED	NONE	24.8	23.9	34.5	40	37	194	39.3	45	42	202	36.2	44	39	196	41.0	50	44	204
		2852/76A00	49.6	47.7	38.9	40	37	194	44.9	45	42	202	41.0	45	39	196	47.0	50	44	204
		2862/77A00	74.4	71.6	68.6	70	63	194	74.6	80	69	202	70.8	80	65	196	76.8	80	71	204
575-3-60	HIGH	NONE	24.8	23.9	36.2	45	39	221	41.0	50	44	229	37.9	45	41	223	42.7	50	46	231
		2852/76A00	49.6	47.7	41.0	45	39	221	47.0	50	44	229	43.1	45	41	223	49.1	50	46	231
		2862/77A00	74.4	71.6	82.7	90	93	221	88.7	90	98	229	78.9	80	72	223	84.9	90	100	231
575-3-60	ULTRA HIGH	NONE	24.8	23.9	40.5	50	43	232	45.3	50	48	240	42.2	50	45	234	47.0	60	50	242
		2852/76A00	49.6	47.7	45.6	50	43	232	51.6	60	48	240	47.8	50	45	234	53.8	60	50	242
		2862/77A00	74.4	71.6	87.4	100	97	232	93.4	100	102	240	89.5	100	99	234	95.5	100	104	242

See Legend and Notes on page 74

ELECTRICAL DATA (cont.)

Table 46 (cont.) - UNIT WIRE SIZING DATA WITH FACTORY-INSTALLED HACR BREAKER

UNIT	IFM TYPE	ELEC. HTR				NO C.O. or UNPWR C.O.										w/ PWRD C.O.									
		CR/HEATER**A00 VERT/HORZ	Nom (kW)	FLA	MCA	NO P.E.			w/ P.E. (pwrd frtunit)			NO P.E.			w/ P.E. (pwrd frtunit)			NO P.E.			w/ P.E. (pwrd frtunit)				
						HACR BRKR	DISC. SIZE FLA LRA	MCA	HACR BRKR	DISC. SIZE FLA LRA	MCA	HACR BRKR	DISC. SIZE FLA LRA	MCA	HACR BRKR	DISC. SIZE FLA LRA	MCA	HACR BRKR	DISC. SIZE FLA LRA	MCA					
50LC**24	STD	NONE	-	-	-	101.9	538	113.7	125	588	121	588	106.7	125	543	118.5	150	563	127	563	127/127	563/563			
		2792/70A00	18.8/25.0	52.1/60.1	101.9/101.9	538/538	113.7/113.7	125/125	588/588	121/121	588/588	106.7/106.7	125/125	543/543	118.5/118.5	150/150	563/563	127/127	563/563	127/127	563/563				
		2802/71A00	37.6/50.0	104.2/120.3	156.8/156.8	538/538	113.7/113.7	125/125	588/588	121/121	588/588	106.7/106.7	125/125	543/543	118.5/118.5	150/150	563/563	127/127	563/563	127/127	563/563				
	MED	2812/72A00	56.3/75.0	156.4/180.4	206.9/206.9	538/538	113.7/113.7	125/125	588/588	121/121	588/588	106.7/106.7	125/125	543/543	118.5/118.5	150/150	563/563	127/127	563/563	127/127	563/563				
		NONE	-	-	-	101.9	538	113.7	125	588	121	588	106.7	125	543	118.5	150	563	127	563	127/127	563/563			
		2792/70A00	18.8/25.0	52.1/60.1	101.9/101.9	538/538	113.7/113.7	125/125	588/588	121/121	588/588	106.7/106.7	125/125	543/543	118.5/118.5	150/150	563/563	127/127	563/563	127/127	563/563				
	HIGH	2802/71A00	37.6/50.0	104.2/120.3	156.8/156.8	538/538	113.7/113.7	125/125	588/588	121/121	588/588	106.7/106.7	125/125	543/543	118.5/118.5	150/150	563/563	127/127	563/563	127/127	563/563				
		2812/72A00	56.3/75.0	156.4/180.4	206.9/206.9	538/538	113.7/113.7	125/125	588/588	121/121	588/588	106.7/106.7	125/125	543/543	118.5/118.5	150/150	563/563	127/127	563/563	127/127	563/563				
		NONE	-	-	-	108.7	612	120.5	125	632	129	632	113.5	125	617	125.3	150	637	135	637	135/135	637/637			
ULTRA HIGH	2792/70A00	18.8/25.0	52.1/60.1	101.9/101.9	612/612	120.5/120.5	125/125	632/632	129/129	632/632	113.5/113.5	125/125	617/617	125.3/125.3	150/150	637/637	135/135	637/637	135/135	637/637					
	2802/71A00	37.6/50.0	104.2/120.3	156.8/156.8	612/612	120.5/120.5	125/125	632/632	129/129	632/632	113.5/113.5	125/125	617/617	125.3/125.3	150/150	637/637	135/135	637/637	135/135	637/637					
	2812/72A00	56.3/75.0	156.4/180.4	206.9/206.9	612/612	120.5/120.5	125/125	632/632	129/129	632/632	113.5/113.5	125/125	617/617	125.3/125.3	150/150	637/637	135/135	637/637	135/135	637/637					
460-3-60	STD	NONE	-	-	-	56.6	278	62.8	80	290	67	290	58.8	80	280	65.0	80	292	70	292	70	292			
		2832/73A00	25.0	30.1	56.6	278	62.8	80	290	67	290	58.8	80	290	65.0	80	292	70	292	70	292				
		2832/74A00	50.0	60.1	72.2	278	62.8	80	290	67	290	58.8	80	290	65.0	80	292	70	292	70	292				
	MED	2842/75A00	75.0	90.2	102.3	278	62.8	80	290	67	290	58.8	80	290	65.0	80	292	70	292	70	292				
		NONE	-	-	-	56.6	278	62.8	80	290	67	290	58.8	80	290	65.0	80	292	70	292	70	292			
		2822/73A00	25.0	30.1	56.6	278	62.8	80	290	67	290	58.8	80	290	65.0	80	292	70	292	70	292				
	HIGH	2832/74A00	50.0	60.1	72.2	278	62.8	80	290	67	290	58.8	80	290	65.0	80	292	70	292	70	292				
		2842/75A00	75.0	90.2	102.3	278	62.8	80	290	67	290	58.8	80	290	65.0	80	292	70	292	70	292				
		NONE	-	-	-	60.6	315	66.8	70	327	62.8	62.8	62.8	80	327	69.0	80	329	80	329	80	329			
ULTRA HIGH	2822/73A00	25.0	30.1	56.6	315	66.8	80	327	62.8	62.8	62.8	80	327	69.0	80	329	80	329	80	329					
	2832/74A00	50.0	60.1	72.2	315	66.8	80	327	62.8	62.8	62.8	80	327	69.0	80	329	80	329	80	329					
	2842/75A00	75.0	90.2	102.3	315	66.8	80	327	62.8	62.8	62.8	80	327	69.0	80	329	80	329	80	329					
575-3-60	STD	NONE	-	-	-	63.8	335	70.0	80	347	75	347	66.0	80	337	72.2	80	349	78	349	78	349			
		2822/73A00	25.0	30.1	63.8	335	70.0	80	347	75	347	66.0	80	337	72.2	80	349	78	349	78	349				
		2832/74A00	50.0	60.1	81.2	335	70.0	80	347	75	347	66.0	80	337	72.2	80	349	78	349	78	349				
	MED	2842/75A00	75.0	90.2	111.3	335	70.0	80	347	75	347	66.0	80	337	72.2	80	349	78	349	78	349				
		NONE	-	-	-	45.0	206	49.8	50	214	46.7	46.7	46.7	50	214	51.5	50	216	56	216	56	216			
		2852/76A00	24.8	23.9	45.0	206	49.8	50	214	46.7	46.7	46.7	50	214	51.5	50	216	56	216	56	216				
	HIGH	2862/77A00	49.6	47.7	68.6	206	49.8	50	214	46.7	46.7	46.7	50	214	51.5	50	216	56	216	56	216				
		2872/78A00	74.4	71.6	80.6	206	49.8	50	214	46.7	46.7	46.7	50	214	51.5	50	216	56	216	56	216				
		NONE	-	-	-	46.7	233	51.5	50	241	48.4	48.4	48.4	50	241	53.2	50	243	58	243	58	243			
ULTRA HIGH	2852/76A00	24.8	23.9	45.0	233	51.5	50	241	48.4	48.4	48.4	50	241	53.2	50	243	58	243	58	243					
	2862/77A00	49.6	47.7	68.6	233	51.5	50	241	48.4	48.4	48.4	50	241	53.2	50	243	58	243	58	243					
	2872/78A00	74.4	71.6	80.6	233	51.5	50	241	48.4	48.4	48.4	50	241	53.2	50	243	58	243	58	243					

See Legend and Notes on page 74

ELECTRICAL DATA (cont.)

Table 46 (cont.) - UNIT WIRE SIZING DATA WITH FACTORY-INSTALLED HACR BREAKER

UNIT	NO M, V-PH-HZ	ELEC. HTR			NO C.O. or UNPWR C.O.						w/ PWRD C.O.					
		CRHEATER**A00 VERT/HORZ	Nom (kW)	FLA	NO P.E.			w/ P.E. (pwrd frtunit)			NO P.E.			w/ P.E. (pwrd frtunit)		
					MCA	HACR BRKR	DISC. SIZE FLA LRA	MCA	HACR BRKR	DISC. SIZE FLA LRA	MCA	HACR BRKR	DISC. SIZE FLA LRA	MCA	HACR BRKR	DISC. SIZE FLA LRA
STD	208/230-3-60	NONE	-	-	129	69	142	649	129.7	175	134	634	141.5	175	148	654
		279/270A00	18.8/25.0	52.1/60.1	129/129	629/629	142/142	649/649	129.7/129.7	175/175	134/134	634/634	141.5/141.5	175/175	148/148	654/654
		280/271A00	37.6/50.0	104.2/120.3	144/163	629/629	158/176	649/649	162.8/162.8	225/250	150/168	634/634	177.5/177.5	200/200	163/182	654/654
MED	208/230-3-60	NONE	-	-	204/232	629/629	218/245	649/649	212.9/212.9	175	210/237	634/634	227.7/227.7	250/250	223/251	654/654
		279/270A00	18.8/25.0	52.1/60.1	137	703	150	723	136.5/136.5	175	142	708	148.3/148.3	175	156	728
		280/271A00	37.6/50.0	104.2/120.3	137/137	703/703	150/150	723/723	136.5/136.5	175/175	142/142	708/708	148.3/148.3	175/175	156/156	728/728
HIGH	208/230-3-60	NONE	-	-	212/240	703/703	226/253	723/723	221.4/221.4	200/200	218/245	708/708	236.2/236.2	250/250	231/259	728/728
		279/270A00	18.8/25.0	52.1/60.1	147	743	161	763	145.8/145.8	200	153	748	157.6/157.6	200	167	768
		280/271A00	37.6/50.0	104.2/120.3	147/147	743/743	161/161	763/763	145.8/145.8	200/200	153/153	748/748	157.6/157.6	200/200	167/167	768/768
STD	460-3-60	NONE	-	-	223/250	743/743	236/264	763/763	233.0/233.0	90	228/256	748/748	247.8/247.8	250/300	242/269	768/768
		282/273A00	25.0	30.1	68	322	75	334	67.1/67.1	90	70	324	73.3/73.3	90	78	336
		283/274A00	50.0	60.1	80	334	87	334	75.0/75.0	90	83	324	82.7/82.7	90	90	336
MED	460-3-60	NONE	-	-	115	322	122	334	105.1/105.1	125	117	334	112.8/112.8	125	125	336
		282/273A00	25.0	30.1	73	359	80	371	71.1/71.1	90	75	361	77.3/77.3	100	82	373
		283/274A00	50.0	60.1	85	359	92	371	80.0/80.0	90	87	361	87.7/87.7	100	95	373
HIGH	460-3-60	NONE	-	-	119	359	127	371	110.1/110.1	125	122	361	117.8/117.8	125	129	373
		282/273A00	25.0	30.1	76	379	83	391	74.3/74.3	90	79	381	80.5/80.5	100	86	393
		283/274A00	50.0	60.1	89	379	96	391	84.0/84.0	100	91	381	91.7/91.7	100	98	393
STD	575-3-60	NONE	-	-	123	379	130	391	114.1/114.1	125	126	381	121.8/121.8	125	133	393
		285/276A00	24.8	23.9	56	235	62	243	55.6/55.6	60	58	237	60.4/60.4	80	64	245
		286/277A00	49.6	47.7	63	235	69	243	70.8/70.8	70	65	237	76.8/76.8	80	71	245
MED	575-3-60	NONE	-	-	91	235	96	243	88.7/88.7	90	93	237	88.7/88.7	90	98	245
		285/276A00	24.8	23.9	58	262	64	270	57.3/57.3	70	60	264	62.1/62.1	80	66	272
		286/277A00	49.6	47.7	65	262	71	270	72.9/72.9	70	67	264	78.9/78.9	80	73	272
HIGH	575-3-60	NONE	-	-	93	262	98	270	84.9/84.9	90	95	264	90.9/90.9	100	100	272
		285/276A00	24.8	23.9	62	273	68	281	61.0/61.0	80	64	275	65.8/65.8	80	70	283
		286/277A00	49.6	47.7	69	273	75	281	71.5/71.5	80	71	275	77.5/77.5	80	77	283

See Legend and Notes on page 74

ELECTRICAL DATA (cont.)

LEGEND & NOTES

- LEGEND:**
- BRKR - Circuit breaker
 - C.O. - Convenience outlet
 - DISC - Disconnect
 - FLA - Full load amps
 - IFM - Indoor Fan Motor
 - LRA - Locked rotor amps
 - MCA - Minimum circuit amps
 - PE. - Power exhaust
 - pwrd fr/unit - Powered from unit
 - PWRD C.O. - Powered convenience outlet
 - UNPWR C.O. - Unpowered convenience outlet

NOTES:

1. In compliance with NEC requirements for multimotor and combination load equipment (refer to NEC Articles 430 and 440), the overcurrent protective device for the unit shall be fuse or HACR breaker. Canadian units may be fuse or circuit breaker.
2. For 208/230 v units, where one value is shown it is the same for either 208 or 230 volts.
3. **Unbalanced 3-Phase Supply Voltage**
Never operate a motor where a phase imbalance in supply voltage is greater than 2%. Use the following formula to determine the percentage of voltage imbalance.

$$\% \text{ Voltage Imbalance} = 100 \times \frac{\text{max voltage deviation from average voltage}}{\text{average voltage}}$$

Example: Supply voltage is 230-3-60



- AB = 224 V
- BC = 231 V
- AC = 226 V

$$\text{Average Voltage} = \frac{(224 + 231 + 226)}{3} = \frac{681}{3} = 227$$

Determine maximum deviation from average voltage.

$$(AB) 227 - 224 = 3 \text{ V}$$

$$(BC) 231 - 227 = 4 \text{ V}$$

$$(AC) 227 - 226 = 1 \text{ V}$$

Maximum deviation is 4 v.

Determine percent of voltage imbalance.

$$\% \text{ Voltage Imbalance} = 100 \times \frac{4}{227} = 1.76\%$$

This amount of phase imbalance is satisfactory as it is below the maximum allowable 2%.

IMPORTANT: If the supply voltage phase imbalance is more than 2%, contact your local electric utility company immediately.

TYPICAL WIRING DIAGRAMS

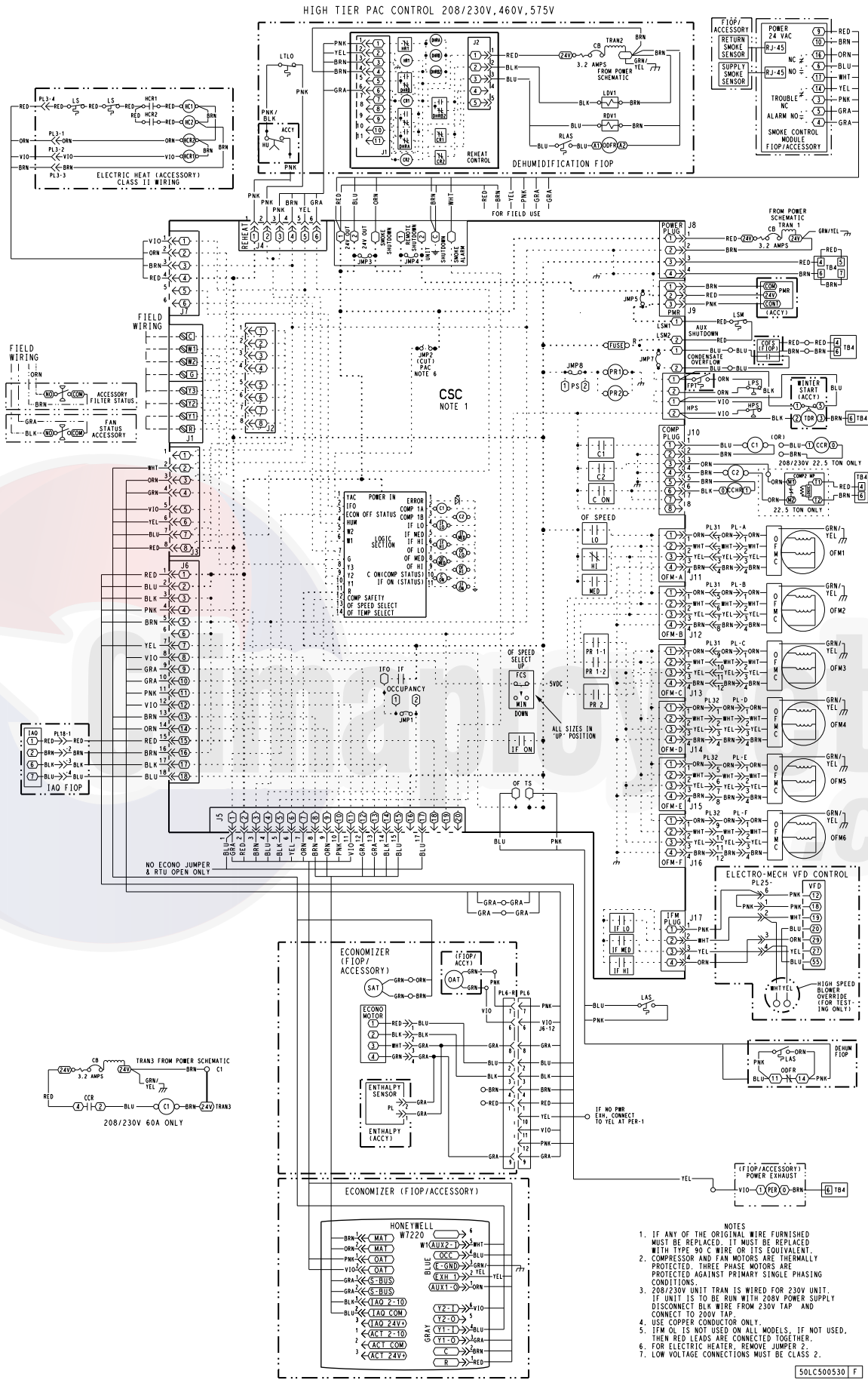

Fig. 16 - 50LC 14-26 Typical Electromechanical Control Wiring Diagram

TYPICAL WIRING DIAGRAMS (cont.)

12.5 - 20 TON YAC, PAC POWER 208/230V 3 PH WITH/WITHOUT HOT GAS REHEAT FIOP

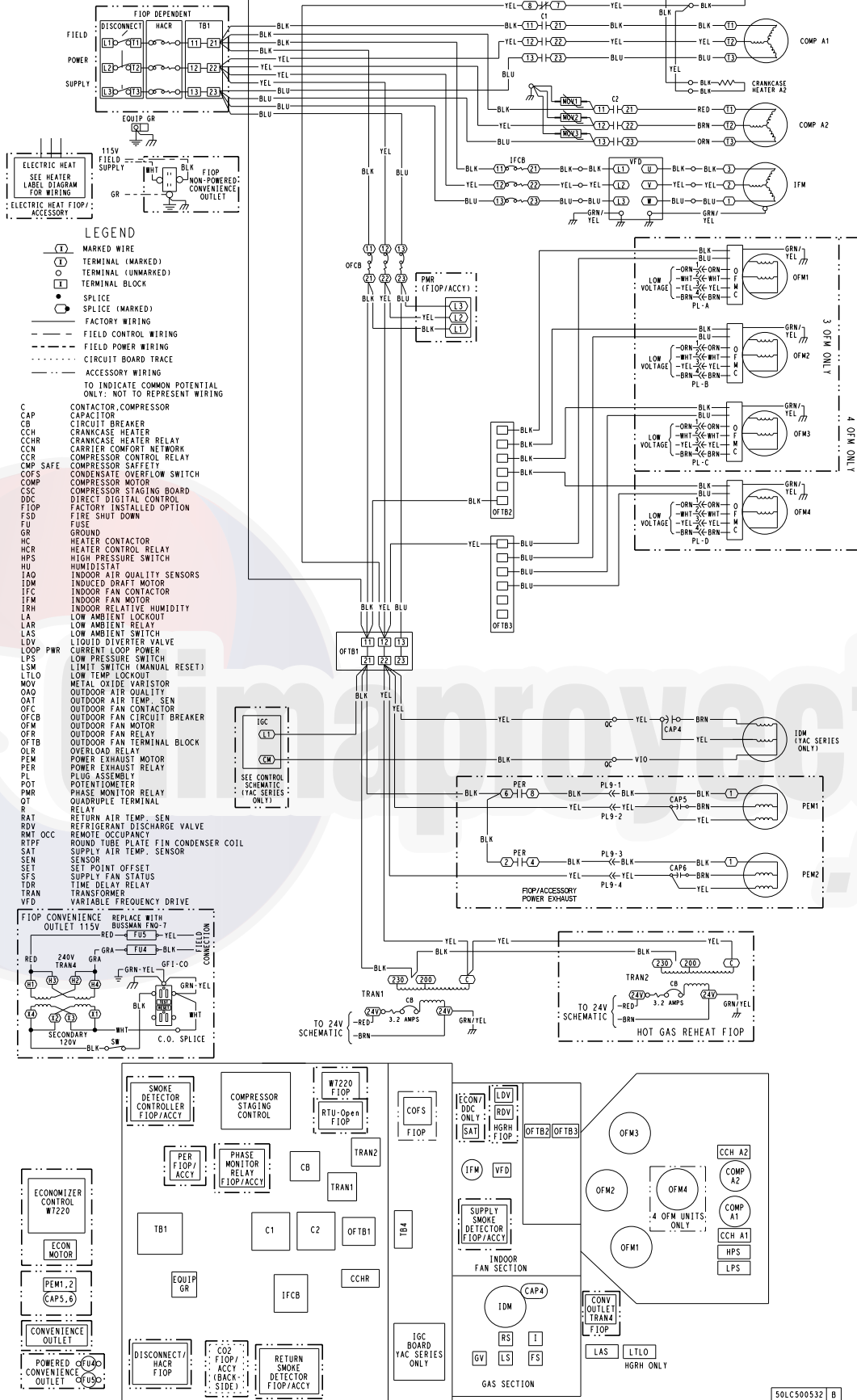

Fig. 19 - Typical Power Wiring Diagram, 50LC 14-20 208/230V Shown

NOTE: Power Wiring Diagram is typical for electromechanical, SystemVu™ and RTU Open units.

SEQUENCE OF OPERATION

General

The Carrier Integrated Staging Control Board (ISC) is intended for use with a standard thermostat capable of three cooling stages. After initial power to the board, a Green LED will blink with a 1 second duty cycle indicating the unit is running properly. When the unit is not running properly, the Green LED will blink along with Red LED lights. The Red LED light configuration will indicate the type of error the board has identified.

The ISC board can be remotely shutdown by removing Jumper 4 and wiring to the Remote Shutdown terminal. The Smoke Control Module can shut down the unit by removing Jumper 3 and wiring to the Smoke Shutdown terminal. A smoke alarm can be obtained by wiring to the Smoke Alarm terminal.

The crankcase heater will run at all times except when the compressors are running. An auxiliary power supply (24Vac) available at TB-4 Terminal is provided to power auxiliary equipment. An optional Phase Monitor Relay can be wired to the PMR terminal by removing Jumper 5.

Ventilation

In the Ventilation/Fan Mode (G on the thermostat), the indoor fan will run at low speed and the damper will operate at minimum position.

Cooling

In the Cooling Mode, the small and large compressors will be sequenced to maintain the thermostat/DDC temperature setpoint. Table 47 shows the cooling operation based on the following conditions.

The outdoor fan and VFD controlled indoor-fan will operate at low, medium and high speed. The indoor-fan speed (rpm) is factory set by the CFM and static pressure requirements for the unit installed.

Humidi-MiZer® (Optional)

In the Dehumidification Mode, both compressors will run and Indoor airflow will rise to High Speed.

In subcooling mode (reheat-1), during part load conditions when the room temperature and humidity are above the set point, the unit initiates the sub-cooling mode of operation; a call for cooling and dehumidification. RDV (Reheat Discharge Valve) and TWV (Three Way Valve) close; Indoor and Outdoor airflow will rise until reaching 100% of Speed.

In hot gas reheat mode (reheat-2), when there is a call for dehumidification without a call for cooling, a portion of the hot gas from the compressor bypasses the condenser coil when RDV opens and hot gas is fed into the liquid line, TWV closes in this mode and the system provides mainly latent cooling. Indoor airflow will rise until reaching 100% of Speed, Outdoor airflow will run at High speed as long as outdoor temperature is above 80°F (26.7°C); when operating in this mode below 80°F (26.7°C) OAT, the system outdoor fan will operate as shown in the table below based on Size:

LC Size	RPM	Number of Fan On	Number of Fan Off
14	250	3	0
17	255	4	0
20	160	4	0
24	250	6	0
26	250	6	0

Table 47 – COOLING OPERATION

INPUT	OUTPUT			
	Compressor C1	Compressor C2	Indoor Fan Speed	Outdoor Fan Speed
Thermostat				
First Stage Cooling (Y1)	On	Off	Low	Low (700 rpm)
Second Stage Cooling (Y2)	Off	On	Medium	Medium (800 rpm)
Third Stage Cooling (Y3)	On	On	High	High (1,000 rpm)

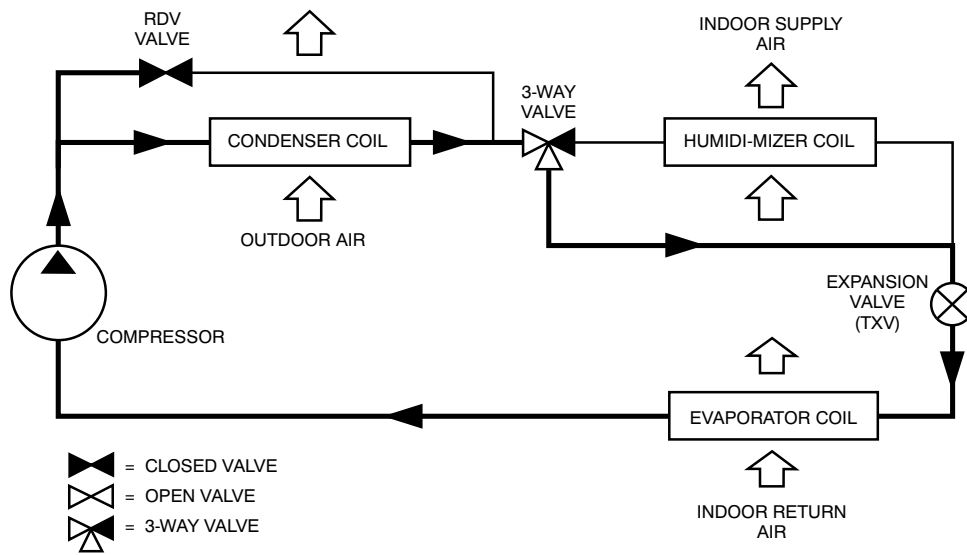

Fig. 20 - Humidi-MiZer® Piping Schematic Normal Cooling

C14114

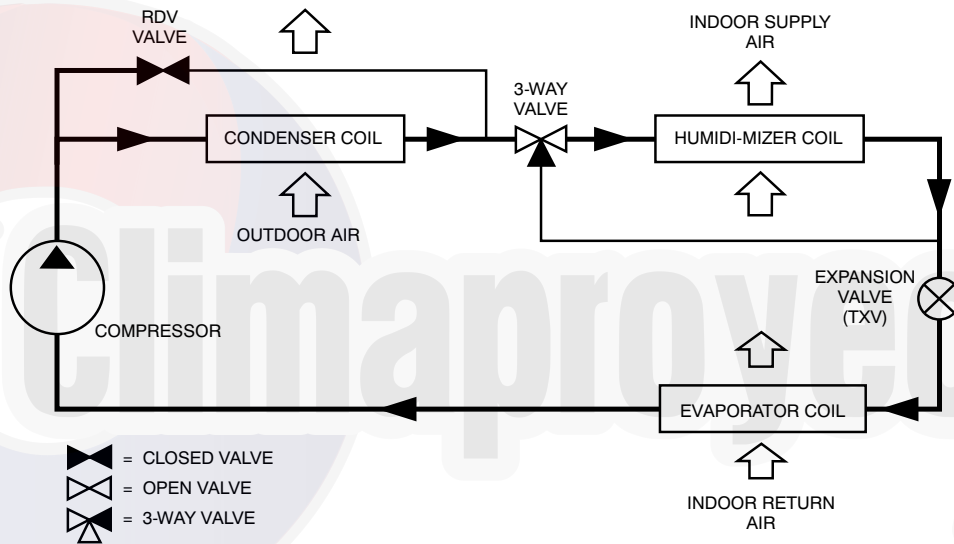

Fig. 21 - Humidi-MiZer Piping Schematic Subcooling Mode (Reheat1)

C14115

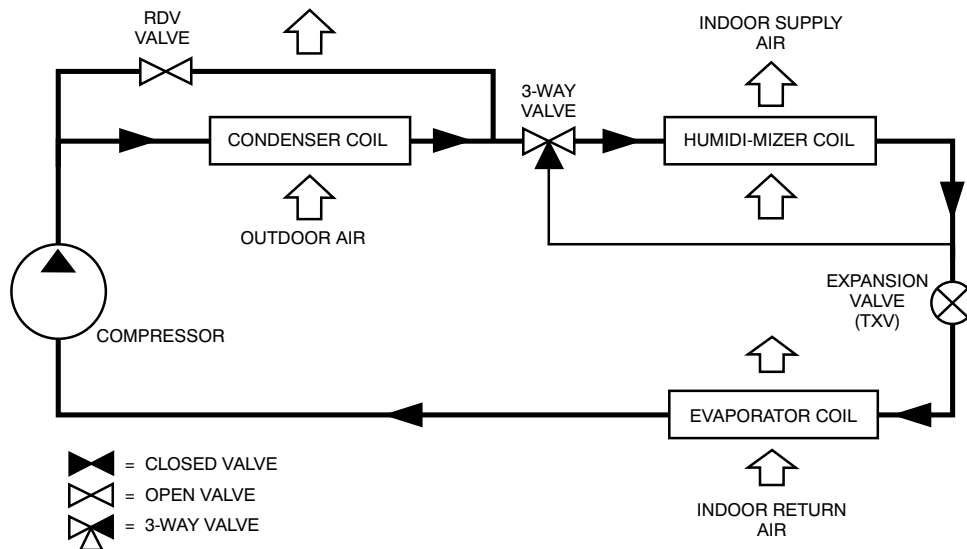

Fig. 22 - Humidi-MiZer Piping Schematic Hot Gas Reheat Mode (Reheat 2)

C14116

Economizer (Optional)

When the Economizer is in Free Cooling Mode and a demand for cooling exists (Y1 on the thermostat), the Economizer will modulate the outdoor-air damper to provide a 50°F (10°C) to 55°F (13°C) mixed-air temperature into the zone and run the indoor-fan at high speed. As mixed-air temperature fluctuates above 55°F (13°C) or below 50°F (10°C) dampers will be modulated (open or close) to bring the mixed-air temperature back within control. Upon more call for cooling (Y2 on the thermostat), the outdoor-air damper will maintain its current position, compressor C1 will run and the outdoor-fan will run at low speed. If there is further demand for cooling, the outdoor-air damper will maintain its current position, only compressor C2 will run and the outdoor fan will run at medium speed. The VFD controlled indoor fan will operate at high speed regardless of the cooling demand.

If the increase in cooling capacity causes the mixed-air temperature to drop below 45°F, the outdoor-air damper will return to the minimum position. If the mixed-air temperature continues to fall, the outdoor-air damper will close. Once the mixed air temperature rises above 48°F (9°C), the control returns to normal. The power exhaust fans will be energized and de-energized, if installed, as the outdoor-air damper opens and closes.

In field-installed accessory CO₂ sensors are connected to the Economizer, a demand controlled ventilation strategy will begin to operate. As the CO₂ level in the zone increases above the CO₂ setpoint, the minimum position of the damper will be increased proportionally. As the CO₂ level decreases because of the increase of fresh air, the outdoor-air damper will be proportionally closed. For economizer operation, there must be a thermostat call for the fan (G). If the unit is occupied and the fan is on, the damper will operate at minimum position. Otherwise, the damper will be closed.

Low Ambient Cooling Operation down to 40°F (4°C)

In Low Ambient RTU conditions when the temperature is between 55°F (13°C) and 40°F (4°C), the Low Ambient Switch (LAS) will be active and the outdoor-fans will run to the pre-set factory outdoor-fan speed. When the temperature is greater than 65°F (18°C), the Low Ambient Switch will deactivate and the outdoor-fans will run in the standard cooling mode. If the Outdoor Fan Select Switch (see Fig. 23) is in the up position, the outdoor fans will run in the Fan Cycle Speed Mode (FCS)

set to 250 rpm. If the Outdoor Fan Select Switch is in the down position, the outdoor fans will run in the Minimum Fan Speed Mode (MIN) set to 160 rpm regardless of the cooling demand.

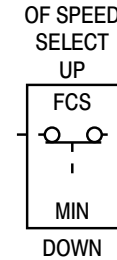

C13327

Fig. 23 - Outdoor Fan Speed Select Switch

LC size 14 through 26 units have a SPST normally open Low Ambient Switch wired across the TS and OF terminal and a jumper placed across the PS terminal (See Fig. 24). When the LAS is active, the switch will close making contact to the OF terminal. This is done for units that require all outdoor fans to run at the same pre-set factory Low Ambient Speed.

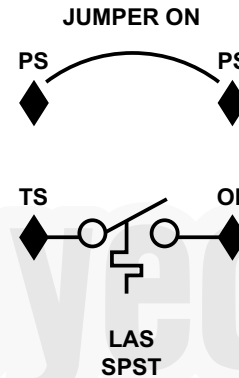

C13328

Fig. 24 - Schematic of SPST Low Ambient Switch

The Low Ambient Outdoor Fan Control chart (Table 48) shows the operation of the outdoor fans for each unit.

Heating

In the Heating Mode (W1 on the thermostat), power is applied to the G and W1 terminal at the ISC board and energizes the first state of electric heat. Upon more call for heat (W2 at the thermostat), power is applied to the G and W2 terminal at the ISC board and energizes the second state of electric heat. The VFD controlled indoor fan will operate at high speed regardless of the heating demand.

Table 48 – LOW AMBIENT TEMPERATURE OUTDOOR FAN CONTROL

LC Size	No. of Fans On	No. of Fans Off	Switch	Low Ambient Switch Fig. No.	Outdoor Fan Select Switch	RPM
14	3	0	(1) SPST	24	Up	250
17	4	0	(1) SPST	24	Up	250
20	4	0	(1) SPST	24	Up	250
24	6	0	(1) SPST	24	Up	250
26	6	0	(1) SPST	24	Up	250

SystemVu Control (Factory Option)

For details on operating 50LC units equipped with the factory-installed SystemVu controls option refer to *48/50LC 07-26 Single Package Rooftop Units with SystemVu Controls Version 1.X and PURON (R-410A) Refrigerant Controls, Start-Up, Operation and Troubleshooting* (Catalog No.: S-VU-LC-7-26-02T or later).

RTU Open (Factory Option)

For details on operating 50LC units equipped with the factory-installed RTU Open option refer to *48/50LC-07-26 Factory Installed Option RTU Open Multi-Protocol Controller Controls, Start-Up, Operation and Troubleshooting* (Catalog No.: 48-50LC-7-26-2T, or later).



GUIDE SPECIFICATIONS – 50LC**14-26

Note about this specification:

These specifications are written in “Masterformat” as published by the Construction Specification Institute. Please feel free to copy this specification directly into your building spec.

WeatherExpert® Ultra High-Efficiency Cooling Only/Electric Heat Packaged Rooftop



HVAC Guide Specifications:

Size Range: 12.5 to 23 Nominal Tons

<u>Section</u>	<u>Description</u>
----------------	--------------------

23 06 80	Schedules for Decentralized HVAC Equipment
-----------------	---

- | | |
|----------------|---|
| 23 06 80.13 | Decentralized Unitary HVAC Equipment Schedule |
| 23 06 80.13.A. | Rooftop unit schedule |
| 1. | Schedule is per the project specification requirements. |

23 07 16	HVAC Equipment Insulation
-----------------	----------------------------------

- | | |
|----------------|--|
| 23 07 16.13 | Decentralized, Rooftop Units: |
| 23 07 16.13.A. | Evaporator fan compartment: |
| 1. | Interior cabinet surfaces shall be insulated with a minimum 1/2-in. thick, minimum 1 1/2 lb density aluminum foil-faced insulation on the air side. |
| 2. | Insulation and adhesive shall meet NFPA 90A requirements for flame spread and smoke generation. |
| 3. | Unit internal insulation linings shall be resistant to mold growth in accordance with “mold growth and humidity” test in ASTM C1338, G21, and UL 181 or comparable test method. Air stream surfaces shall be evaluated in accordance with the “Erosion Test” in UL 181, as part of ASTM C1071. |
| 23 07 16.13.B. | Electric heat compartment: |
| 1. | Aluminum foil-faced fiberglass insulation shall be used. |
| 2. | Insulation and adhesive shall meet NFPA 90A requirements for flame spread and smoke generation. |

23 09 13	Instrumentation and Control Devices for HVAC
-----------------	---

- | | |
|----------------|---|
| 23 09 13.23 | Sensors and Transmitters |
| 23 09 13.23.A. | Thermostats |
| 1. | Thermostat must |
| a. | energize both “W” and “G” when calling for heat. |
| b. | have capability to energize 3 different stages of cooling, and 2 different stages of heating. |
| c. | include capability for occupancy scheduling. |

23 09 23	Direct Digital Control (DDC) System for HVAC
-----------------	---

- | | |
|----------------|---|
| 23 09 23.13 | Decentralized, Rooftop Units: |
| 23 09 23.13.A. | SystemVu™ intelligent integrated Direct Digital Control (DDC) shall provide: |
| 1. | Integrated unit operation for comfort cooling, heating ventilation as well as all monitoring, recording and reporting capabilities. Controller shall also provide diagnostics and alarms of abnormal unit operation through the controller. Controller shall have an intuitive user display and be able to be used in a standalone operation or via building automation system (BAS). |
| 2. | Quick Unit Status LED's of: Run – meaning all systems are go, ALERT – that indicates there is currently a non-critical issue with the unit, like filters need to be replaced and FAULT – that indicates the unit has a critical issue and will possibly shut down. |
| 3. | Six large navigation keys for easy access. Navigation keys shall consist of: TEST, BACK, ENTER, and MENU along with UP and DOWN arrows. |
| 4. | Full back lit user display with 4 line by 30 character text capabilities. Display menu shall be designed to provide guided major menus and sub menus main menus provided below: |
| — | Shutdown Unit |

- Run Status
 - Settings
 - Alerts/Faults
 - Service
 - Inputs
 - Outputs
 - USB
5. The capability for standalone operation with conventional thermostat/sensor or use with building automation systems (BAS) of Carrier i-Vu[®], BACnet* and Carrier Comfort Network[®] (CCN) systems. No special modules or boards are required for these capabilities.
 6. The ability to read refrigerant pressures at display or via BAS network of; Discharge Pressure, Suction Pressure and Liquid Line Pressure. The need for traditional refrigerant gauges is not required.
 7. USB Data Port for flash drive exchange. This will allow the transfer of data for uploads, downloads, perform software upgrades, back-up and restore data and file transfer data such as component number of starts and run hours.
 8. Reverse Rotation Protection of compressors if field three phase wiring is misapplied.
 9. Provide Service Capabilities of:
 - Auto run test
 - Manual run test
 - Component run hours and starts
 - Commissioning reports
 - Data logging
 - Alarm history
 10. Economizer control and diagnostics. Set up economizer operation, receive feedback from actuator. Also meets the most recent California Title 24 Fault Detection and Diagnostic (FDD) requirements.
 11. Unit cooling operation down to 0°F (-18°C)
 12. Controller shall have easy access connections around the controller perimeter area and consist of Mate-N-Lok, terminal block and RJ style modular jack connections.
 13. 365 day real time clock, 20 holiday schedules along with occupied and unoccupied scheduling.
 14. Auto-Recognition for easy installation and commissioning of devices like economizers, space sensors etc.
 15. A 5°F temperature difference between cooling and heating set points to meet the latest ASHRAE 90.1-2013 Energy Standard.
 16. Contain return air sensor, supply air sensor and outdoor air sensor to help monitor and provide data for the unit comfort operation, diagnostic and alarms.
 17. Use of Carrier's field accessory hand-held Navigator™ display.
 18. Control of the operation of unit VFD (Variable Frequency Drive) to work in conjunction with the cooling, heating and ventilation modes.
 19. 3-year limited part warranty
- 23.09.23.13.B. RTU Open - multi-protocol, direct digital controller:
1. Shall be ASHRAE 62 compliant.
 2. Shall accept 18-30VAC, 50-60Hz, and consume 15VA or less power.
 3. Shall have an operating temperature range from -40°F (-40°C) to 130°F (54°C), 10% - 90% RH (non-condensing).
 4. Shall include built-in protocol for BACnet (MS/TP and PTP modes), Modbus[†] (RTU and ASCII), Johnson N2 and LonWorks. LonWorks** Echelon processor required for all Lon applications shall be contained in separate communication board.
 5. Shall allow access of up to 62 network variables (SNVT). Shall be compatible with all open controllers
 6. Baud rate Controller shall be selectable using a dipswitch.
 7. Shall have an LED display independently showing the status of serial communication, running, errors, power, all digital outputs, and all analog inputs.
 8. Shall accept the following inputs: space temperature, setpoint adjustment, outdoor air temperature, indoor air quality, outdoor air quality, compressor lock-out, fire shutdown, enthalpy switch, and fan status/filter status/humidity/ remote occupancy.
 9. Shall provide the following outputs: economizer, fan, cooling stage 1, cooling stage 2, heat stage 1, heat stage 2, heat stage 3/ exhaust/ reversing valve.

* BACnet is a registered trademark of ASHRAE (American Society of Heating, Refrigerating and Air-Conditioning Engineers).

† Modbus is a registered trademark of Schneider Electric.

** LonWorks is a registered trademark of Echelon Corporation.

10. Shall have built-in surge protection circuitry through solid state polyswitches. Polyswitches shall be used on incoming power and network connections. Polyswitches will return to normal when the “trip” condition clears.
11. Shall have a battery back-up capable of a minimum of 10,000 hours of data and time clock retention during power outages.
12. Shall have built-in support for Carrier technician tool.
13. Shall include an RS-485 protocol communication port, an access port for connection of either a computer or a Carrier technician tool, an EIA-485 port for network communication to intelligent space sensors and displays, and a port to connect an optional LonWorks communications card.
14. Software upgrades will be accomplished by either local or remote download. No software upgrades through chip replacements are allowed.

23 09 33 Integrated Staging Control (ISC) System for HVAC (Electro-Mechanical units)

23 09 33.13 Decentralized, Rooftop Units:

23 09 33.13.A. General:

1. Shall be complete with self-contained low-voltage control circuit protected by a resettable circuit breaker on the 24-v transformer side. Transformer shall have 75VA capability.
2. Shall utilize color-coded wiring.
3. Shall include an ISC electro-mechanical control board, to conveniently and safely provide connection points for vital control functions such as: smoke detectors, phase monitor, gas controller, economizer, thermostat, and safety switches. Shall control all three stages of compressor logic, two or three stages of the indoor fan motor logic as well as staging of the outdoor fan motor. Shall also have a green LED indicator to indicate GO operation as well as a fault LED indicator for thermostat mis-wiring, no fan operation and safety switches.
NOTE: Does not apply to units equipped with SystemVu™ controls.
4. Unit shall include a minimum of one 8-pin screw terminal connection board for connection of control wiring.

23 09 33.13.B. Safeties:

1. Compressor over-temperature, over current.
2. Low-pressure switch.
 - a. Low-pressure switch shall use different color wire than the high pressure switch. The purpose is to assist the installer and service technician to correctly wire and or troubleshoot the rooftop unit.
NOTE: Does not apply to units equipped with SystemVu™ controls.
3. High-pressure switch.
 - a. High-pressure switch shall use different color wire than the low pressure switch. The purpose is to assist the installer and service technician to correctly wire and or troubleshoot the rooftop unit.
4. Automatic reset, motor thermal overload protector.

23 09 93 Sequence of Operations for HVAC Controls

23 09 93.13 Decentralized, Rooftop Units:

23 09 93.13.A. INSERT SEQUENCE OF OPERATION

23 40 13 Panel Air Filters

23 40 13.13 Decentralized, Rooftop Units:

23 40 13.13.A. Standard filter section

1. Shall consist of factory-installed, low velocity, throwaway 2-in. thick fiberglass filters of commercially available sizes.
2. Unit shall use only one filter size. Multiple sizes are not acceptable.
3. Filters shall be accessible through a dedicated, weather tight panel.
4. 4-in filter capabilities shall be capable with pre-engineered and approved Carrier filter track field-installed accessory. This kit requires field furnished filters.

23 81 19 Self-Contained Air Conditioners

23 81 19.13 Medium-Capacity Self-Contained Air Conditioners (50LC**14-26)

23 81 19.13.A. General

1. Outdoor, rooftop mounted, ISC electrically controlled, heating and cooling unit utilizing hermetic scroll compressors for cooling duty and optional electric heat for heating duty.
2. Factory assembled, single-piece heating and cooling rooftop unit. Contained within the unit enclosure shall be all factory wiring, piping, controls, and special features required prior to field start-up.
3. Unit shall use Puron® (R-410A) refrigerant.
4. Unit shall be installed in accordance with the manufacturer’s instructions.

5. Unit must be selected and installed in compliance with local, state, and federal codes.

23 81 19.13.B. Quality Assurance

1. Unit meets and exceeds ASHRAE 90.1-2013 minimum efficiency requirements.
2. Unit shall be rated in accordance with AHRI Standard 340/360.
3. Unit shall be designed to conform to ASHRAE 15.
4. Unit shall be ETL-tested and certified in accordance with ANSI Z21.47 Standards and ETL-listed and certified under Canadian standards as a total package for safety requirements.
5. Insulation and adhesive shall meet NFPA 90A requirements for flame spread and smoke generation.
6. Unit internal insulation linings shall be resistant to mold growth in accordance with “mold growth and humidity” test in ASTM C1338, G21, and UL 181 or comparable test method. Air stream surfaces shall be evaluated in accordance with the “Erosion Test” in UL 181, as part of ASTM C1071.
7. Unit casing shall be capable of withstanding 500-hour salt spray exposure per ASTM B117 (scribed specimen).
8. Roof curb shall be designed to conform to NRCA Standards.
9. Unit shall be subjected to a completely automated run test on the assembly line. The data for each unit will be stored at the factory, and must be available upon request.
10. Unit shall be designed in accordance with UL Standard 1995, including tested to withstand rain.
11. Unit shall be constructed to prevent intrusion of snow and tested to prevent snow intrusion into the control box up to 40 mph.
12. Unit shake tested to assurance level 1, ASTM D4169 to ensure shipping reliability.
13. High-Efficiency Motors listed shall meet section 313 of the Energy Independence and Security Act of 2007 (EISA 2007)

23 81 19.13.C. Delivery, Storage, and Handling

1. Unit shall be stored and handled per manufacturer’s recommendations.
2. Lifted by crane requires either shipping top panel or spreader bars.
3. Unit shall only be stored or positioned in the upright position.

23 81 19.13.D. Project Conditions

1. As specified in the contract.

23 81 19.13.E. Operating Characteristics

1. Unit shall be capable of starting and running at 125°F (52°C) ambient outdoor temperature, meeting maximum load criteria of AHRI Standard 340/360 at ± 10% voltage.
2. Compressor with standard controls shall be capable of operation from 40°F (4°C), ambient outdoor temperatures. For lower operation an integrated economizer shall be utilized to allow lower temperatures and accommodate indoor air quality initiatives
3. Unit shall discharge supply air vertically or horizontally as shown on contract drawings.
4. Unit shall be factory configured and ordered for vertical supply & return configurations.
5. Unit shall be factory furnished for either vertical or horizontal configuration without the use of special conversion kits. No field kits conversion is possible.
6. Unit shall be capable of mixed operation: vertical supply with horizontal return or horizontal supply with vertical return.

23 81 19.13.F. Electrical Requirements

1. Main power supply voltage, phase, and frequency must match those required by the manufacturer.

23 81 19.13.G. Unit Cabinet

1. Unit cabinet shall be constructed of galvanized steel, and shall be bonderized and coated with a pre-painted baked enamel finish on all externally exposed surfaces.
2. Unit cabinet exterior paint shall be: film thickness, (dry) 0.003 inches minimum, gloss (per ASTM D523, 60°F): 60, Hardness: H-2H Pencil hardness.
3. Evaporator fan compartment interior cabinet insulation shall conform to AHRI Standards 340/360 minimum exterior sweat criteria. Interior surfaces shall be insulated with a minimum 1/2-in. thick, 1 lb density aluminum foil-faced fiberglass insulation. Aluminum foil-faced fiberglass insulation shall also be used in the heat compartment.
4. Unit internal insulation linings shall be resistant to mold growth in accordance with “mold growth and humidity” test in ASTM C1338, G21, and UL 181 or comparable test method. Air stream surfaces shall be evaluated in accordance with the “Erosion Test” in UL 181, as part of ASTM C1071.
5. Base of unit shall have a minimum of four locations for factory thru-the-base electrical connections. Connections shall be internal to the cabinet to protect from environmental issues.
6. Base Rail
 - a. Unit shall have base rails on a minimum of 2 sides.

- b. Holes shall be provided in the base rails for rigging shackles to facilitate maneuvering and overhead rigging.
 - c. Holes shall be provided in the base rail for moving the rooftop by fork truck.
 - d. Base rail shall be a minimum of 16 gauge thickness.
7. Condensate pan and connections:
- a. Shall be a sloped condensate drain pan made of a non-corrosive material.
 - b. Shall comply with ASHRAE Standard 62.
 - c. Shall use a 3/4-in -14 NPT drain connection at the end of the drain pan. Connection shall be made per manufacturer's recommendations.
8. Top panel:
- a. Shall be a multi-piece top panel linked with water tight flanges and interlocking systems.
9. Electrical Connections
- a. All unit power wiring shall enter unit cabinet at a single, factory-prepared, knockout location.
 - b. Thru-the-base capability
 - (1.) Thru-the-base provisions/connections are available as standard with every unit. When bottom connections are required, field furnished couplings are required.
 - (2.) No basepan penetration, other than those authorized by the manufacturer, is permitted.
10. Component access panels (standard)
- a. Cabinet panels shall be easily removable for servicing.
 - b. Unit shall have one factory-installed, tool-less, removable, filter access panel.
 - c. Panels covering control box and filters shall have molded composite handles while the blower access door shall have an integrated flange for easy removal.
 - d. Handles shall be UV modified, composite, permanently attached, and recessed into the panel.
 - e. Screws on the vertical portion of all removable access panel shall engage into heat resistant, molded composite collars.
 - f. Collars shall be removable and easily replaceable using manufacturer recommended parts.

23 81 19.13.H. Coils

1. Standard Aluminum Fin/Copper Tube Coils:
 - a. Standard evaporator and condenser coils shall have aluminum lanced plate fins mechanically bonded to seamless internally grooved 5/16" diameter copper tubes with all joints brazed.
 - b. Evaporator coils shall be leak tested to 150 psig, pressure tested to 450 psig, and qualified to UL 1995 burst test at 1775 psig.
 - c. Condenser coils shall be leak tested to 150 psig, pressure tested to 650 psig, and qualified to UL 1995 burst test at 1980 psig.
2. Optional Pre-coated aluminum-fin condenser coils:
 - a. Shall have a durable epoxy-phenolic coating to provide protection in mildly corrosive coastal environments.
 - b. Coating shall be applied to the aluminum fin stock prior to the fin stamping process to create an inert barrier between the aluminum fin and copper tube.
 - c. Epoxy-phenolic barrier shall minimize galvanic action between dissimilar metals.
 - d. Corrosion durability of fin stock shall be confirmed through testing to be no less than 1000 hours salt spray per ASTM B117-90.
 - e. Corrosion durability of fin stock shall be confirmed through testing to have no visible corrosion after 48 hour immersion in a room temperature solution of 5% salt, 1% acetic acid.
 - f. Fin stock coating shall pass 2000 hours of the following: one week exposure in the prohesion chamber followed by one week of accelerated ultraviolet light testing. Prohesion chamber: the solution shall contain 3.5% sodium chloride and 0.35% ammonium sulfate. The exposure cycle is one hour of salt fog application at ambient followed by one hour drying at 95°F (35°C).
3. Optional Copper-fin evaporator and condenser coils:
 - a. Shall be constructed of copper fins mechanically bonded to copper tubes and copper tube sheets.
 - b. Galvanized steel tube sheets shall not be acceptable.
 - c. A polymer strip shall prevent coil assembly from contacting the sheet metal coil pan to minimize potential for galvanic corrosion between coil and pan.
4. Optional E-coated aluminum-fin evaporator and condenser coils:
 - a. Shall have a flexible epoxy polymer coating uniformly applied to all coil surface areas without material bridging between fins.
 - b. Coating process shall ensure complete coil encapsulation of tubes, fins and headers.

- c. Color shall be high gloss black with gloss per ASTM D523-89.
- d. Uniform dry film thickness from 0.8 to 1.2 mil on all surface areas including fin edges.
- e. Superior hardness characteristics of 2H per ASTM D3363-92A and cross-hatch adhesion of 4B-5B per ASTM D3359-93.
- f. Impact resistance shall be up to 160 in.-lb (ASTM D2794-93).
- g. Humidity and water immersion resistance shall be up to minimum 1000 and 250 hours respectively (ASTM D2247-92 and ASTM D870-92).
- h. Corrosion durability shall be confirmed through testing to be no less than 6000 hours salt spray per ASTM B117-90.

23 81 19.13.I. Refrigerant Components

1. Refrigerant circuit shall include the following control, safety, and maintenance features:
 - a. Thermostatic Expansion Valve (TXV) shall help provide optimum performance across the entire operating range. Shall contain removable power element to allow change out of power element and bulb without removing the valve body.
 - b. Refrigerant filter drier.
 - c. Service gauge connections on suction and discharge lines.
 - d. Pressure gauge access through a specially designed screen on the side of the unit.
 - e. Single circuit design with tandem compressor and fully activated evaporator coil
2. Compressors
 - a. Models shall use one fully hermetic tandem scroll compressors optimized for comfort staging and IEER energy savings.
 - b. Models shall be available with a single refrigerant circuit and three stage cooling operation on all models.
 - c. Compressor motors shall be cooled by refrigerant gas passing through motor windings.
 - d. Compressors shall be internally protected from high discharge temperature conditions.
 - e. Compressors shall be protected from an over-temperature and over-ampereage conditions by an internal, motor overload device.
 - f. Compressor shall be factory mounted on rubber grommets.
 - g. Compressor motors shall have internal line break thermal, current overload and high pressure differential protection.
 - h. Crankcase heaters shall be standard on each compressor and deactivated whenever a compressor is in operation.

23 81 19.13.J. Filter Section

1. Filters access is specified in the unit cabinet section of this specification.
2. Filters shall be held in place by a preformed slide out filter tray, facilitating easy removal and installation.
3. Shall consist of factory-installed, low velocity, throw-away 2-in. thick fiberglass filters.
4. Filters shall be standard, commercially available sizes.
5. Only one size filter per unit is allowed.
6. 4-in filter capability is possible with a field-installed pre-engineered slide out filter track accessory. 4-in filters are field furnished.

23 81 19.13.K. Evaporator Fan and Motor

1. Evaporator fan motor:
 - a. Shall have permanently lubricated bearings.
 - b. Shall have inherent automatic-reset thermal overload protection or circuit breaker.
 - c. Shall have a maximum continuous bhp rating for continuous duty operation; no safety factors above that rating shall be required.
 - d. Shall be Variable Frequency duty to match the three stage compression logic.
 - e. Shall contain motor shaft grounding ring to prevent electrical bearing fluting damage by safely diverting harmful shaft voltages and bearing currents to ground.
2. Variable Frequency Drive (VFD). For indoor fan motor Staged Air Volume (SAV™) operation:
 - a. Shall be installed inside the unit cabinet, mounted, wired and tested.
 - b. Shall contain Electromagnetic Interference (EMI) frequency protection.
 - c. Insulated Gate Bi-Polar Transistors (IGBT) used to produce the output pulse width modulated (PWM) waveform, allowing for quiet motor operation.
 - d. Self-diagnostics with fault and power code LED indicator. Field accessory Display Kit available for further diagnostics and special setup applications.
 - e. RS485 capability standard.

- f. Electronic thermal overload protection.
 - g. 5% swinging chokes for harmonic reduction and improved power factor.
 - h. All printed circuit boards shall be conformal coated.
 - i. Shall not contain visual display to adjust internal setting. Only available as field-installed kit.
3. Belt-driven Evaporator Fan:
- a. Belt drive shall include an adjustable-pitch motor pulley and belt break protection system.
 - b. Shall use rigid pillow block bearing system with lubricate fittings at are accessible or lubrication line.
 - c. Blower fan shall be double-inlet type with forward-curved blades.
 - d. Shall be constructed from steel with a corrosion resistant finish and dynamically balanced.

23 81 19.13.L. Condenser Fans and Motors

- 1. Condenser fan motors:
 - a. Shall be a totally enclosed – multi-speed ECM motor.
 - b. Shall use permanently lubricated bearings.
 - c. Shall have inherent thermal overload protection with an automatic reset feature.
 - d. Shall use a shaft-down design.
- 2. Condenser Fans:
 - a. Shall be a direct-driven propeller type fan.
 - b. Shall have galvanized aluminum (galvalum) blades riveted to corrosion-resistant steel spiders and shall be dynamically balanced.

23 81 19.13.M. Special Features, Options and Accessories

- 1. Standard Leak Economizers:
 - a. Available as factory-installed option (vertical or horizontal) or field-installed accessory (vertical or horizontal) on all electro-mechanical and RTU Open models. SystemVu™ field-installed accessory (vertical or horizontal) also available.
 - b. Standard leak economizers are available with EconoMi\$er X controls for electro-mechanical units, or EconoMi\$er2 controls for RTU Open or SystemVu units.
 - c. Integrated, gear driven opposed blade design type capable of simultaneous economizer and compressor operation.
 - d. Damper blades shall be galvanized steel with composite gears. Plastic or composite blades on intake or return shall not be acceptable.
 - e. Shall be equipped with gear driven dampers for both the outdoor ventilation air and the return air for positive air stream control.
 - f. Standard leak rate models shall be equipped with leakage dampers, not to exceed 2% leakage at 1 in. wg pressure differential.
 - g. Shall be capable of introducing up to 100% outdoor air.
 - h. Economizer's barometric relief dampers shall be sized to allow up to 100% relief (actual results will be based on specific job conditions).
 - 2. Ultra-Low Leak Economizers:
 - a. Available as a factory-installed option (vertical or horizontal) or field-installed accessory (vertical or horizontal) on all models including: electro-mechanical, RTU Open, and SystemVu.
 - b. Ultra-Low Leak economizer dampers meet California's Title 24 section 140.4 prescriptive requirements for leakage, reliability testing, etc., and ASHRAE 90.1-2013 requirements for damper leakage.
 - c. Economizers are available with EconoMi\$er X controls for electro-mechanical units, or EconoMi\$er2 controls for RTU Open or SystemVu units.
 - d. Integrated, gear driven opposed blade design type capable of simultaneous economizer and compressor operation.
 - e. Damper blades shall be galvanized steel with composite gears. Plastic or composite blades on intake or return shall not be acceptable.
 - f. Shall be equipped with gear driven dampers for both the outdoor ventilation air and the return air for positive air stream control.
 - g. Shall be capable of introducing up to 100% outdoor air.
 - h. Economizer's barometric relief dampers shall be sized to allow up to 100% relief (actual results will be based on specific job conditions).
- (1.) EconoMi\$er X Economizer Controls:

- a. For use with factory-installed (vertical or horizontal) or field-installed accessory (vertical or horizontal) on electro-mechanical units with standard leak or Ultra-Low Leak economizers.
 - b. Meets California's Title 24 section 120.2 mandatory requirements for economizer Fault Detection and Diagnosis (FDD).
 - c. Economizer controller shall be Honeywell W7220 JADE that provides:
 - i. 2-line LCD interface screen for setup, configuration and troubleshooting.
 - ii. On-board FDD detects and alerts when economizer is not operating properly.
 - iii. Sensor failure loss of communication identification.
 - iv. Automatic sensor detection.
 - v. Capabilities for use with multi-speed indoor fan units.
 - d. Compressor lockout temperature on W7220 is adjustable from -45 to 80°F, set at a factory default of 32°F.
 - e. Shall be designed to spring return close outside air damper during loss of power.
 - f. Actuator shall be direct coupled to economizer gear. No linkage arms or control rods shall be acceptable.
 - g. Utilizes digital dry bulb or enthalpy outside air sensors. Factory-installed economizers available with dry bulb or enthalpy. Dry bulb sensors installed on all field-installed economizer accessories.
- (2.) EconoMi\$er2 Economizer Controls:
- a. For use with factory-installed (vertical or horizontal) or field-installed accessory (vertical or horizontal) on RTU Open or SystemVu™ units with standard leak or Ultra-Low Leak economizers. Note: Factory-installed EconoMi\$er2 is available on SystemVu™ units with Ultra-Low Leak economizers only.
 - b. EconoMi\$er2 economizers are controlled by RTU Open or SystemVu unit controllers, which shall be 4-20mA design.
 - c. RTU Open and SystemVu controls meet California's Title 24 section 120.2 mandatory requirements for economizer Fault Detection and Diagnosis.
 - d. Available on factory-installed (vertical only) economizers with dry bulb or enthalpy outside air sensors. Field-installed accessories (vertical or horizontal) are available with dry bulb outside air sensors only.
 - e. Outdoor air sensor setpoint shall be adjustable and shall range from 40 to 100°F (4 to 38°C). Additional sensor options shall be available as accessories.
 - f. Shall be designed to spring return close outside air damper during loss of power.
 - g. Actuator shall be direct coupled to economizer gear. No linkage arms or control rods shall be acceptable.
 - h. The economizer controller shall also provide control of an accessory power exhaust unit function. Factory set at 100%, with a range of 0% to 100%.
 - i. The economizer shall maintain minimum airflow into the building during occupied period and provide design ventilation rate for full occupancy.
 - j. Controller shall drive outside air dampers completely closed when the unit is in the unoccupied mode.
 - k. Economizer controller shall accept a 4-20mA CO₂ sensor input for IAQ/DCV control. In this mode, dampers shall modulate the outdoor air damper to provide ventilation based on the sensor input.
 - l. Economizer controller shall provide indications when in free cooling mode, in the DCV mode, or the exhaust fan contact is closed.
3. Condenser Coil Hail Guard Assembly
- a. Shall protect against damage from hail.
 - b. Shall be louvered style design.
4. Unit-Mounted, Non-Fused Disconnect Switch:
- a. Switch shall be factory-installed, internally mounted.
 - b. National Electric Code (NEC) and ETL approved non-fused switch shall provide unit power shutoff.
 - c. Shall be accessible from outside the unit
 - d. Shall provide local shutdown and lockout capability
 - e. Sized only for the unit as ordered from the factory. Does not accommodate field-installed devices
5. HACR Breaker
- a. These manual reset devices provide overload and short circuit protection for the unit. Factory wired and mounted with the units, with access cover to help provide environmental protection. On 575V applications, HACR breaker can only be used with WYE power distribution systems. Use on Delta power distribution systems is prohibited.
 - b. Sized only for the unit as ordered from the factory. Does not accommodate field-installed devices.
6. Convenience Outlet:
- a. Powered convenience outlet.
 - (1.) Outlet shall be powered from main line power to the rooftop unit.

- (2.) Outlet shall be powered from line side of disconnect by installing contractor, as required by code. If outlet is powered from load side of disconnect, unit electrical ratings shall be ETL certified and rated for additional outlet amperage.
 - (3.) Outlet shall be factory-installed and internally mounted with easily accessible 115-v female receptacle.
 - (4.) Outlet shall include 15 amp GFI receptacles with independent fuse protection.
 - (5.) Voltage required to operate convenience outlet shall be provided by a factory-installed step-down transformer.
 - (6.) Outlet shall be accessible from outside the unit.
 - (7.) Outlet shall include a field-installed "Wet in Use" cover.
- b. Non-Powered convenience outlet.
- (1.) Outlet shall be powered from a separate 115/120v power source.
 - (2.) A transformer shall not be included.
 - (3.) Outlet shall be factory-installed and internally mounted with easily accessible 115-v female receptacle.
 - (4.) Outlet shall include 15 amp GFI receptacles with independent fuse protection.
 - (5.) Outlet shall be accessible from outside the unit.
 - (6.) Outlet shall include a field-installed "Wet in Use" cover.
7. Fan/Filter Status Switch:
- a. Switch shall provide status of indoor evaporator fan (ON/OFF) or filter (CLEAN/DIRTY).
 - b. Status shall be displayed either over communication bus (when used with direct digital controls) or with an indicator light at the thermostat.
8. Centrifugal Power Exhaust:
- a. Power exhaust shall be used in conjunction with an integrated economizer.
 - b. Independent modules for vertical or horizontal return configurations shall be available.
 - c. Horizontal power exhaust is shall be mounted in return ductwork.
 - d. Power exhaust shall be controlled by economizer controller operation. Exhaust fans shall be energized when dampers open past the 0-100% adjustable setpoint on the economizer control.
9. Roof Curbs (Vertical):
- a. Full perimeter roof curb with exhaust capability providing separate air streams for energy recovery from the exhaust air without supply air contamination.
 - b. Formed galvanized steel with wood nailer strip and shall be capable of supporting entire unit weight.
 - c. Permits installation and securing of ductwork to curb prior to mounting unit on the curb.
10. High-Static Indoor Fan Motor(s) and Drive(s):
- a. High-static motor(s) and drive(s) shall be factory-installed to provide additional performance range.
11. Outdoor Air Enthalpy Sensor:
- a. The outdoor air enthalpy sensor shall be used to provide single enthalpy control. When used in conjunction with a return air enthalpy sensor, the unit will provide differential enthalpy control. The sensor allows the unit to determine if outside air is suitable for free cooling.
12. Return Air Enthalpy Sensor:
- a. The return air enthalpy sensor shall be used in conjunction with an outdoor air enthalpy sensor to provide differential enthalpy control.
13. Indoor Air Quality (CO₂) Sensor:
- a. Shall be able to provide demand ventilation indoor air quality (IAQ) control.
 - b. The IAQ sensor shall be available in duct mount, wall mount, or wall mount with LED display. The setpoint shall have adjustment capability.
14. Smoke detectors:
- a. Shall be a Four-Wire Controller and Detector.
 - b. Shall be environmental compensated with differential sensing for reliable, stable, and drift-free sensitivity.
 - c. Shall use magnet-activated test/reset sensor switches.
 - d. Shall have tool-less connection terminal access.
 - e. Shall have a recessed momentary switch for testing and resetting the detector.
 - f. Controller shall include:
 - (1.) One set of normally open alarm initiation contacts for connection to an initiating device circuit on a fire alarm control panel.
 - (2.) Two Form-C auxiliary alarm relays for interface with rooftop unit or other equipment.

- (3.) One Form-C supervision (trouble) relay to control the operation of the Trouble LED on a remote test/reset station.
 - (4.) Capable of direct connection to two individual detector modules.
 - (5.) Can be wired to up to 14 other duct smoke detectors for multiple fan shutdown applications.
15. Horn/Strobe Annunciator
- a. Provides an audible/visual signaling device for use with factory-installed option or field-installed accessory smoke detectors.
 - (1.) Requires installation of a field-supplied 24-v transformer suitable for 4.2 VA (AC) or 3.0 VA (DC) per horn/strobe accessory.
 - (2.) Requires field-supplied electrical box, North American 1-gang box, 2-in (51 mm) x 4-in (102 mm).
 - (3.) Shall have a clear colored lens.
16. Time Guard
- a. Shall prevent compressor short cycling by providing a 5-minute delay (± 2 minutes) before restarting a compressor after shutdown for any reason.
 - b. One device shall be required per compressor.
17. Electric Heat:
- a. Heating Section
 - (1.) Heater element open coil resistance wire, nickel-chrome alloy, 0.29 inches inside diameter, strung through ceramic insulators mounted on metal frame. Coil ends are staked and welded to terminal screw slots.
 - (2.) Heater assemblies are provided with integral fusing for protection of internal heater circuits not exceeding 48 amps each. Auto reset thermo limit controls, magnetic heater contactors (24 v coil) and terminal block all mounted in electric heater control box (minimum 18 ga galvanized steel) attached to end of heater assembly.
18. Barometric Hood (Horizontal Economizer Applications)
- a. Shall be required when a horizontal economizer and barometric relief are required. Barometric relief damper must be installed in the return air (horizontal) duct work. This hood provides weather protection.
19. Hinged Access Panels
- a. Shall provide easy access through integrated quarter turn latches.
 - b. Shall be on major panels of – filter, control box, fan motor and compressor
20. Display Kit for Variable Frequency Drive
- a. Kit allows the ability to access the VFD controller programs to provide special setup capabilities and diagnostics.
 - b. Kit contains display module and communication cable.
 - c. Display Kit can be permanently installed in the unit or used on any SAV™ system VFD controller as needed.
21. Thermostat:
- a. Due to the three stage cooling capacity design of these units, a three stage cooling thermostat is required for the unit to perform at listed operating efficiencies.
 - b. Carrier offers a Honeywell branded T7350D (3 Cool/3 Heat) Commercial Programmable Thermostat. This provides:
 - 7-day programmable 365-day clock with holiday programming
 - Automatic Daylight Saving Time adjustment
 - Backlit display
 - Changeover selections: automatic or manual
 - Fan configurable: continuous or intermittent during occupied
22. Humidi-MiZer Adaptive® Dehumidification System:
- a. The Humidi-MiZer Adaptive Dehumidification System shall be factory-installed, certified and tested to provide greater dehumidification of the occupied space by providing two distinct modes of dehumidification operation in addition to its normal design cooling mode:
 - (1.) Subcooling mode further sub cools the hot liquid refrigerant leaving the condenser coil as well as reheat leaving air stream. It can provide both better cooling capacity as well as dehumidification process when both temperature and humidity in the space are not satisfied.
 - (2.) Hot gas reheat mode shall mix a portion of hot gas from the discharge of compressor with the hot liquid refrigerant leaving the condenser coil to create a two-phase warm refrigerant in the reheat coil which results in a neutral leaving air temperature when only humidity in the space is not satisfied.