



**First Co.**

**Commercial Products**  
**Chilled Water - Hot Water - Electric Heat**

**Top Quality Commercial Air Handlers & Fan Coils**

8273 Moberly Lane. Dallas, TX. 75227 - Ph. (214) 388-5751 - Fax (214) 388-2255

# Welcome . . . . .

Thank you for your interest in First Co. and its products.

This catalog includes basic information for all of our products. For more detailed information, please use the CD ROM (if included) on the inside of the back cover, which includes:

- Complete Product Specifications, including:
  - o Features / Benefits
  - o Unit Dimensions
  - o Performance Data
  - o Electrical Data
- Efficiency Information

You can also obtain the CD-ROM by calling or e-mailing us at [sales@firstco.com](mailto:sales@firstco.com).

Additional information is available at [www.firstco.com](http://www.firstco.com), where you can also:

1. Download the most current product specifications

The web site is updated continuously and is accessible at all times.

- Contact us











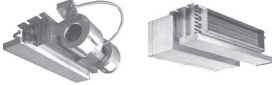
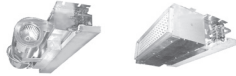







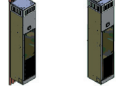

You may contact First Co. by:

Phone..... 214-388-5751

Fax..... 214-388-2255

e-mail..... [sales@firstco.com](mailto:sales@firstco.com)

**Your Sales Representative:**

<b>INDEX</b>		
<b>PRODUCT</b>		<b>PAGE</b>
<b>HBC/PHBC</b> (400-1200 CFM - Horizontal fan coils. Chilled Water/Hot Water)		4
<b>HH/PHH</b> (400-1200 CFM - Horizontal Direct Drive Chilled Water with electric heat)		5
<b>HYB/PHYB</b> (1200-2000 CFM - Horizontal Direct Drive uncased fan coils. Chilled Water/Hot Water)		6
<b>RHBC/CHBC</b> (400-1200 CFM - Horizontal Cased fan coils. Chilled Water/Hot Water)		7
<b>CW</b> (400-1200 CFM - Vertical Direct Drive Chilled Water, Front/Bottom return)		8
<b>CW-HW</b> (400-1200 CFM - Vertical Direct Drive Chilled Water/Hot Water, Front/Bottom return)		8
<b>CWE</b> (400-1200 CFM - Vertical Direct Drive Chilled Water, Front/Bottom return with Electric Heat)		9
<b>MB/MB-HW/MBE</b> (600-2000 CFM - Horizontal/Vertical Direct Drive Chilled Water/Hot Water/ Electric Heat)		9-10
<b>VMB/VMB-HW/VMBE</b> (Variable Speed 800-2000 CFM - Horizontal/Vertical Direct Drive Chilled Water/Hot Water/ Electric Heat)		11-12
<b>RR/RM/RS</b> (300-1200 CFM - Vertical Hi-Rise) Chilled water / Hot Water / Electric Heat		13-14
<b>WH &amp; XH Double Wall</b> (600-10,000 CFM - Horizontal Belt Drive Chilled Water/Hot Water, DX, and Electric Heat)	 	15-16
<b>SHW/SVW</b> (600-10,000 CFM - Horizontal/Vertical Belt Drive Chilled Water/Hot Water and electric Heat)	 	17
<b>SHX/SVX</b> (600-10,000 CFM - Horizontal/Vertical Belt Drive DX and Electric Heat)	 	18
<b>VCB/VFB/VSB/WCB</b> (300-1200 CFM - Vertical floor consoles. Chilled Water/Hot Water)		12
<b>SHW-DD</b> (800-2000 CFM - Horizontal Direct Drive, Chilled Water and Electric Heat)		19
<b>Ceiling Access Panels</b>		24
<b>Thermostat/Accessories</b>		25
<b>Valve Clusters</b>		25
<b>Belt Drive Accessories</b>		19-23

# HBC

Horizontal Fan Coil (Uncased)  
Chilled / Hot Water

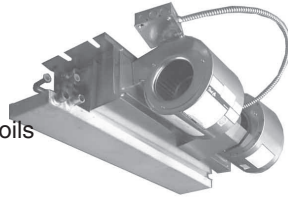

**Features:**

- \* Copper tube aluminum fin coils
- \* Manual air vents
- \* Sloped and Insulated drain pan
- \* 2 and 4-pipe models available
- \* 120V motor (3 speed)
- \* 208/230 motor
- \* 277 motor
- \* 220V, 50 cycle models available

**Option:**

- \* 3-speed, 24V control (contact factory)

RETURN PLENUMS FOR HBC SERIES		
PART NO.	FOR USE WITH	SHIP WT.
916-1-STK	3HBC	18
916-2-STK	4HBC	22
916-3-STK	5/6HBC	22
916-4-STK	8HBC	24
916-5-STK	10HBC	27
916-6-STK	13HBC	30



	UNIT MODEL	NOMINAL CFM	COIL ROWS	DIMENSIONS			EST. SHIP. WT.
				H	W	D	
2-PIPE	3HBC-3	300	3-COOL OR HEAT	10	30-1/8	21	39
	4HBC-3	400		10	36-1/8	21	48
	5HBC-3	500		10	40-1/8	21	52
	6HBC-3	600		10	40-1/8	21	54
	8HBC-3	800		10	46-1/8	21	57
	10HBC-3	1000		10	52-1/8	21	67
	13HBC-3	1300		10	59-1/8	21	87
2-PIPE	3HBC-4	300	4-COOL OR HEAT	10	30-1/8	21	39
	4HBC-4	400		10	36-1/8	21	48
	5HBC-4	500		10	40-1/8	21	52
	6HBC-4	600		10	40-1/8	21	54
	8HBC-4	800		10	46-1/8	21	57
	10HBC-4	1000		10	52-1/8	21	67
	13HBC-4	1300		10	59-1/8	21	87
4-PIPE	3HBC-31	300	3-COOL, 1-HEAT	10	30-1/8	21	39
	4HBC-31	400		10	36-1/8	21	48
	5HBC-31	500		10	40-1/8	21	52
	6HBC-31	600		10	40-1/8	21	54
	8HBC-31	800		10	46-1/8	21	57
	10HBC-31	1000		10	52-1/8	21	67
	13HBC-31	1300		10	59-1/8	21	87
4-PIPE	3HBC-32	300	3-COOL, 2-HEAT	10	30-1/8	21	39
	4HBC-32	400		10	36-1/8	21	48
	5HBC-32	500		10	40-1/8	21	52
	6HBC-32	600		10	40-1/8	21	54
	8HBC-32	800		10	46-1/8	21	57
	10HBC-32	1000		10	52-1/8	21	67
	13HBC-32	1300		10	59-1/8	21	87
4-PIPE	3HBC-41	300	4-COOL, 1-HEAT	10	30-1/8	21	39
	4HBC-41	400		10	36-1/8	21	48
	5HBC-41	500		10	40-1/8	21	52
	6HBC-41	600		10	40-1/8	21	54
	8HBC-41	800		10	46-1/8	21	57
	10HBC-41	1000		10	52-1/8	21	67
	13HBC-41	1300		10	59-1/8	21	87

**NOTES:**

1. HBC Plenums are field installed kits.
2. See Page 25 for thermostats, valves and other accessories.
3. Shaded areas are normally stock product

# PHBC

Horizontal Fan Coil with Plenum  
Chilled / Hot Water

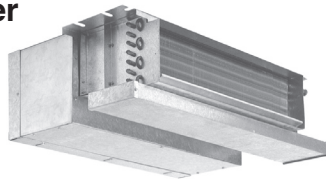

**Features:**

- \* Factory installed return air plenum
- \* Copper tube aluminum fin coils
- \* Easy access throwaway filter
- \* Convertible to bottom return
- \* Manual air vents
- \* Sloped and insulated drain pan
- \* 2 and 4-pipe models available
- \* 120V motor (3-speed)
- \* 277V option available
- \* 220V, 50Hz models available

**Option:**

- \* 3-speed, 24V control (contact factory)



	UNIT MODEL	NOMINAL CFM	COIL ROWS	DIMENSIONS			EST. SHIP. WT.
				H	W	D	
2-PIPE	3PHBC-3	300	3-COOL OR HEAT	10	30-1/8	22-3/4	57
	4PHBC-3	400		10	36-1/8	22-3/4	70
	5PHBC-3	500		10	40-1/8	22-3/4	74
	6PHBC-3	600		10	40-1/8	22-3/4	76
	8PHBC-3	800		10	46-1/8	22-3/4	81
	10PHBC-3	1000		10	52-1/8	22-3/4	94
	13PHBC-3	1300		10	59-1/8	22-3/4	117
2-PIPE	3PHBC-4	300	4-COOL OR HEAT	10	30-1/8	22-3/4	57
	4PHBC-4	400		10	36-1/8	22-3/4	70
	5PHBC-4	500		10	40-1/8	22-3/4	74
	6PHBC-4	600		10	40-1/8	22-3/4	76
	8PHBC-4	800		10	46-1/8	22-3/4	81
	10PHBC-4	1000		10	52-1/8	22-3/4	94
	13PHBC-4	1300		10	59-1/8	22-3/4	117
4-PIPE	3PHBC-31	300	3-COOL, 1-HEAT	10	30-1/8	22-3/4	57
	4PHBC-31	400		10	36-1/8	22-3/4	70
	5PHBC-31	500		10	40-1/8	22-3/4	74
	6PHBC-31	600		10	40-1/8	22-3/4	76
	8PHBC-31	800		10	46-1/8	22-3/4	81
	10PHBC-31	1000		10	52-1/8	22-3/4	94
	13PHBC-31	1300		10	59-1/8	22-3/4	117
4-PIPE	3PHBC-32	300	3-COOL, 2-HEAT	10	30-1/8	22-3/4	57
	4PHBC-32	400		10	36-1/8	22-3/4	70
	5PHBC-32	500		10	40-1/8	22-3/4	74
	6PHBC-32	600		10	40-1/8	22-3/4	76
	8PHBC-32	800		10	46-1/8	22-3/4	81
	10PHBC-32	1000		10	52-1/8	22-3/4	94
	13PHBC-32	1300		10	59-1/8	22-3/4	117
4-PIPE	3PHBC-41	300	4-COOL, 1-HEAT	10	30-1/8	22-3/4	57
	4PHBC-41	400		10	36-1/8	22-3/4	70
	5PHBC-41	500		10	40-1/8	22-3/4	74
	6PHBC-41	600		10	40-1/8	22-3/4	76
	8PHBC-41	800		10	46-1/8	22-3/4	81
	10PHBC-41	1000		10	52-1/8	22-3/4	94
	13PHBC-41	1300		10	59-1/8	22-3/4	117

**NOTES:**

1. See Page 25 for thermostats, valves, and other accessories.

# HH

## Horizontal Fan Coil (Uncased) Chilled Water - With Electric Heat

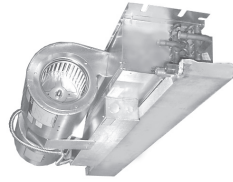

### Features:

- \* Copper tube aluminum fin coils
- \* Manual air vents
- \* 240/24V relay/transformer
- \* Factory installed electric heat
- \* 277V option available
- \* 2-Speed motor
- \* Sloped and insulated drain pan
- \* 220V, 50Hz models available



RETURN PLENUMS FOR HH SERIES		
PART NO.	FOR USE WITH	SHIP WT.
916-7-STK	3HH	18
916-3-STK	4,6,8HH	22
916-4-STK	10HH	22
916-5-STK	12HH	27

NOTES:  
1. Plenums are field installed

UNIT MODEL	NOMINAL CFM	kW (HEAT)	COIL ROWS	DIMENSIONS			EST. SHIP WT.
				H	W	D	
3HHS2,3,4,5-240-3	300	2,3,4,5	3	10	25	21	42
4HHS3,5,6-240-3	400	3,5,6	3	10	40	21	52
6HHS3,5,6-240-3	500	3,5,6	3	10	40	21	78
6HHS8-240-3	500	8	3	10	40	21	78
6HH3,5,6-240-3	600	3,5,6	3	10	40	21	78
6HH8,10-240-3	600	8,10	3	10	40	21	78
8HH5,6-240-3	800	5,6	3	10	40	21	82
8HH8,10-240-3	800	8,10	3	10	40	21	82
10HH5,6-240-3	1000	5,6	3	10	46	21	89
10HH8,10-240-3	1000	8,10	3	10	46	21	89
12HH5,6-240-3	1150	5,6	3	10	52	21	104
12HH8,10,12-240-3	1150	8,10,12	3	10	52	21	104
3HHS2,3,4,5-240-4	300	2,3,4,5	4	10	25	21	42
4HHS3,5,6-240-4	400	3,5,6	4	10	40	21	52
6HHS3,5,6-240-4	450	3,5,6	4	10	40	21	78
6HHS8-240-4	450	8	4	10	40	21	78
6HH3,5,6-240-4	600	3,5,6	4	10	40	21	78
6HH8,10-240-4	600	8,10	4	10	40	21	78
8HH5,6-240-4	800	5,6	4	10	40	21	82
8HH8,10-240-4	800	8,10	4	10	40	21	82
10HH5,6-240-4	1000	5,6	4	10	46	21	89
10HH8,10-240-4	1000	8,10	4	10	46	21	89
12HH5,6-240-4	1200	5,6	4	10	52	21	104
12HH8,10,12-240-4	1200	8,10,12	4	10	52	21	104

### NOTES:

1. See Page 25 for thermostats, valves, and other accessories.

# PHH

## Horizontal Fan Coil With Plenum Chilled Water - With Electric Heat

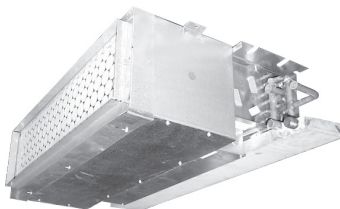

### Features:

- \* Factory installed return air plenum
- \* Copper tube aluminum fin coils
- \* Manual air vents
- \* 240/24V relay/transformer
- \* Factory installed electric heat
- \* 277V option available
- \* 2-Speed motor
- \* Sloped and insulated drain pan
- \* Throwaway filter
- \* 220V, 50Hz models available



UNIT MODEL	NOMINAL CFM	kW (HEAT)	COIL ROWS	DIMENSIONS			EST. SHIP WT.
				H	W	D	
3PHHS2,3,4,5-240-3	300	2,3,4,5	3	10	25	24	60
4PHHS3,5,6-240-3	400	3,5,6	3	10	40	24	74
6PHHS3,5,6-240-3	450	3,5,6	3	10	40	24	100
6PHHS8-240-3	450	8	3	10	40	24	100
6PHH3,5,6-240-3	600	3,5,6	3	10	40	24	100
6PHH8,10-240-3	600	8,10	3	10	40	24	100
8PHH5,6-240-3	800	5,6	3	10	40	24	104
8PHH8,10-240-3	800	8,10	3	10	40	24	104
10PHH5,6-240-3	1000	5,6	3	10	46	24	113
10PHH8,10-240-3	1000	8,10	3	10	46	24	113
12PHH5,6-240-3	1150	5,6	3	10	52	24	131
12PHH8,10,12-240-3	1150	8,10,12	3	10	52	24	131
3PHHS2,3,4,5-240-4	300	2,3,4,5	4	10	25	24	60
4PHHS3,5,6-240-4	400	3,5,6	4	10	40	24	74
6PHHS3,5,6-240-4	450	3,5,6	4	10	40	24	100
6PHHS8-240-4	450	8	4	10	40	24	100
6PHH3,5,6-240-4	600	3,5,6	4	10	40	24	100
6PHH8,10-240-4	600	8,10	4	10	40	24	100
8PHH5,6-240-4	800	5,6	4	10	40	24	104
8PHH8,10-240-4	800	8,10	4	10	40	24	104
10PHH5,6-240-4	1000	5,6	4	10	46	24	113
10PHH8,10-240-4	1000	8,10	4	10	46	24	113
12PHH5,6-240-4	1200	5,6	4	10	52	24	131
12PHH8,10,12-240-4	1200	8,10,12	4	10	52	24	131

### NOTES:

1. See Page 25 for thermostats, valves, and other accessories.

# HYB

Horizontal Fan Coil (uncased)  
Chilled / Hot Water

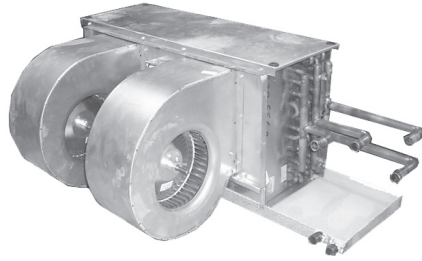

**Features:**

- \* 2 and 4-pipe models available
- \* Copper tube aluminum fin coils
- \* Manual air vents
- \* Sloped and insulated drain pan
- \* 120V motor (3-speed)
- \* 277V option available
- \* 220V, 50Hz models available
- \* 240V, 60Hz models available

**Option:**

- \* 3-speed, 24V control (contact factory)



	UNIT MODEL	NOMINAL CFM	COIL ROWS	DIMENSIONS			EST. SHIP. WT.
				H	W	D	
2-PIPE	12HYB3	1200	3-COOL OR HEAT	16-1/2	41	27	105
	16HYB3	1600		16-1/2	51	27	115
	20HYB3	2000		16-1/2	60	27	125
2-PIPE	12HYB4	1200	4-COOL OR HEAT	16-1/2	41	27	105
	16HYB4	1600		16-1/2	51	27	115
	20HYB4	2000		16-1/2	60	27	125
2-PIPE	12HYB6	1200	6-COOL OR HEAT	16-1/2	41	27	105
	16HYB6	1600		16-1/2	51	27	115
	20HYB6	2000		16-1/2	60	27	125
4-PIPE	12HYB31	1200	3-COOL, 1-HEAT	16-1/2	41	27	105
	16HYB31	1600		16-1/2	51	27	115
	20HYB31	2000		16-1/2	60	27	125
	12HYB32	1200	3-COOL, 2-HEAT	16-1/2	41	27	105
	16HYB32	1600		16-1/2	51	27	115
	20HYB32	2000		16-1/2	60	27	125
	12HYB41	1200	4-COOL, 1-HEAT	16-1/2	41	27	105
	16HYB41	1600		16-1/2	51	27	115
	20HYB41	2000		16-1/2	60	27	125
12HYB42	1200	4-COOL, 2-HEAT	16-1/2	41	27	105	
16HYB42	1600		16-1/2	51	27	115	
20HYB42	2000		16-1/2	60	27	125	

**NOTES:**

1. See Page 25 for thermostats and valve packages.

# PHYB

Horizontal with Plenum  
Chilled / Hot Water

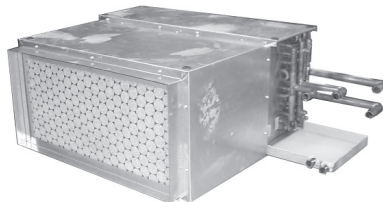

**Features:**

- \* 2 and 4-pipe models available
- \* Factory installed return air plenum
- \* Copper tube aluminum fin coils
- \* Manual air vents
- \* Sloped and insulated drain pan
- \* 277V option available
- \* 220V, 50Hz models available
- \* 240V, 60Hz models available

- \* Insulated return air plenum
- \* Throwaway filter

**Option:**

- \* 3-speed, 24V control (contact factory)



	UNIT MODEL	NOMINAL CFM	COIL ROWS	DIMENSIONS			EST. SHIP. WT.
				H	W	D	
2-PIPE	12PHYB3	1200	3-COOL OR HEAT	16-1/2	41	28-5/8	125
	16PHYB3	1600		16-1/2	51	28-5/8	140
	20PHYB3	2000		16-1/2	60	28-5/8	150
2-PIPE	12PHYB4	1200	4-COOL OR HEAT	16-1/2	41	28-5/8	125
	16PHYB4	1600		16-1/2	51	28-5/8	140
	20PHYB4	2000		16-1/2	60	28-5/8	150
2-PIPE	12PHYB6	1200	6-COOL OR HEAT	16-1/2	41	28-5/8	125
	16PHYB6	1600		16-1/2	51	28-5/8	140
	20PHYB6	2000		16-1/2	60	28-5/8	150
4-PIPE	12PHYB31	1200	3-COOL, 1-HEAT	16-1/2	41	28-5/8	125
	16PHYB31	1600		16-1/2	51	28-5/8	140
	20PHYB31	2000		16-1/2	60	28-5/8	150
	12PHYB32	1200	3-COOL, 2-HEAT	16-1/2	41	28-5/8	125
	16PHYB32	1600		16-1/2	51	28-5/8	140
	20PHYB32	2000		16-1/2	60	28-5/8	150
	12PHYB41	1200	4-COOL, 1-HEAT	16-1/2	41	28-5/8	125
	16PHYB41	1600		16-1/2	51	28-5/8	140
	20PHYB41	2000		16-1/2	60	28-5/8	150
12PHYB42	1200	4-COOL, 2-HEAT	16-1/2	41	28-5/8	125	
16PHYB42	1600		16-1/2	51	28-5/8	140	
20PHYB42	2000		16-1/2	60	28-5/8	150	

**NOTES:**

1. Plenum is field-convertible from rear to bottom return.
2. See Page 25 for thermostats and valve packages.

# RHBC

Chilled / Hot Water Fan Coil  
**Recessed Cabinet With  
 Telescoping Panel**



**Features:**

- \* Telescoping panel allows height adjustment from 12 to 14 inches
- \* Off-white louvered access panel for bottom return
- \* Optional solid panel for end return
- \* Easy access throwaway filter
- \* Copper tube aluminum fin coils
- \* Manual air vents
- \* Sloped and insulated drain pan
- \* 2 and 4-pipe models available
- \* 120V motor (3-speed)
- \* 277V option available
- \* 220V, 50Hz models available

**Option:**

- \* 3-speed, 24V control (contact factory)



	UNIT MODEL	NOMINAL CFM	COIL ROWS	DIMENSIONS			EST. SHIP. WT.
				H	W	D	
2-PIPE	3RHBC-3	300	3-COOL OR HEAT	12	38	24-3/8	90
	4RHBC-3	400		12	44	24-3/8	100
	5RHBC-3	500		12	48	24-3/8	105
	6RHBC-3	600		12	48	24-3/8	105
	8RHBC-3	800		12	54	24-3/8	120
	10RHBC-3	1000		12	60	24-3/8	140
	13RHBC-3	1300		12	67	24-3/8	160
2-PIPE	3RHBC-4	300	4-COOL OR HEAT	12	38	24-3/8	90
	4RHBC-4	400		12	44	24-3/8	100
	5RHBC-4	500		12	48	24-3/8	105
	6RHBC-4	600		12	48	24-3/8	105
	8RHBC-4	800		12	54	24-3/8	120
	10RHBC-4	1000		12	60	24-3/8	140
	13RHBC-4	1300		12	67	24-3/8	160
4-PIPE	3RHBC-31	300	3-COOL, 1-HEAT	12	38	24-3/8	90
	4RHBC-31	400		12	44	24-3/8	100
	5RHBC-31	500		12	48	24-3/8	105
	6RHBC-31	600		12	48	24-3/8	105
	8RHBC-31	800		12	54	24-3/8	120
	10RHBC-31	1000		12	60	24-3/8	140
	13RHBC-31	1300		12	67	24-3/8	160
4-PIPE	3RHBC-32	300	3-COOL, 2-HEAT	12	38	24-3/8	90
	4RHBC-32	400		12	44	24-3/8	100
	5RHBC-32	500		12	48	24-3/8	105
	6RHBC-32	600		12	48	24-3/8	105
	8RHBC-32	800		12	54	24-3/8	120
	10RHBC-32	1000		12	60	24-3/8	140
	13RHBC-32	1300		12	67	24-3/8	160
4-PIPE	3RHBC-41	300	4-COOL, 1-HEAT	12	38	24-3/8	90
	4RHBC-41	400		12	44	24-3/8	100
	5RHBC-41	500		12	48	24-3/8	105
	6RHBC-41	600		12	48	24-3/8	105
	8RHBC-41	800		12	54	24-3/8	120
	10RHBC-41	1000		12	60	24-3/8	140
	13RHBC-41	1300		12	67	24-3/8	160

**NOTES:**

1. Cabinet height is field adjustable from 12 to 14 inches for flush ceiling installation.
2. See Page 25 for thermostats, valves, and other accessories.

# CHBC

Chilled / Hot Water Fan Coil  
**Cabinet Exposed**

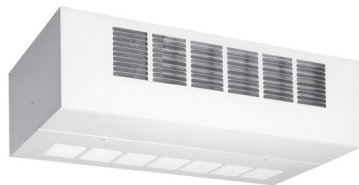

**Features:**

- \* Attractive off-white baked on finish
- \* Removable side panels for easier valve installation
- \* Easy access throwaway filter
- \* Copper tube aluminum fin coils
- \* Hinged access panel
- \* Manual air vents
- \* Insulated condensate drain pan
- \* 2 and 4-pipe models available
- \* 120V motor (3-speed)
- \* 277V option available
- \* 220V, 50Hz models available

**Option:**

- \* 3-speed, 24V control (contact factory)



	UNIT MODEL	NOMINAL CFM	COIL ROWS	DIMENSIONS			EST. SHIP. WT.
				H	W	D	
2-PIPE	3CHBC-3	300	3-COOL OR HEAT	12	38	24	89
	4CHBC-3	400		12	44	24	98
	5CHBC-3	500		12	48	24	107
	6CHBC-3	600		12	48	24	108
	8CHBC-3	800		12	54	24	112
	10CHBC-3	1000		12	60	24	135
	13CHBC-3	1300		12	67	24	147
2-PIPE	3CHBC-4	300	4-COOL OR HEAT	12	38	24	89
	4CHBC-4	400		12	44	24	98
	5CHBC-4	500		12	48	24	107
	6CHBC-4	600		12	48	24	108
	8CHBC-4	800		12	54	24	112
	10CHBC-4	1000		12	60	24	135
	13CHBC-4	1300		12	67	24	147
4-PIPE	3CHBC-31	300	3-COOL, 1-HEAT	12	38	24	89
	4CHBC-31	400		12	44	24	98
	5CHBC-31	500		12	48	24	107
	6CHBC-31	600		12	48	24	108
	8CHBC-31	800		12	54	24	112
	10CHBC-31	1000		12	60	24	135
	13CHBC-31	1300		12	67	24	147
4-PIPE	3CHBC-32	300	3-COOL, 2-HEAT	12	38	24	89
	4CHBC-32	400		12	44	24	98
	5CHBC-32	500		12	48	24	107
	6CHBC-32	600		12	48	24	108
	8CHBC-32	800		12	54	24	112
	10CHBC-32	1000		12	60	24	135
	13CHBC-32	1300		12	67	24	147
4-PIPE	3CHBC-41	300	4-COOL, 1-HEAT	12	38	24	89
	4CHBC-41	400		12	44	24	98
	5CHBC-41	500		12	48	24	107
	6CHBC-41	600		12	48	24	108
	8CHBC-41	800		12	54	24	112
	10CHBC-41	1000		12	60	24	135
	13CHBC-41	1300		12	67	24	147

**NOTES:**

1. See Page 25 for thermostats, valves, and other accessories

## CW

### Vertical Closet or Wall Recessed Chilled Water / Hot Water (2-pipe)

#### Features:

- \* 3-speed, 24V control
- \* Front or bottom return kit (kit required for bottom return)
- \* 120V multi-speed motor
- \* Easily accessible throwaway filter
- \* Sloped thermoplastic drain pan
- \* Primary and secondary drains
- \* Can be hung on a closet wall (kit required)
- \* Installed manual air purge valve
- \* Electrical service pullout

#### Options:

- \* Factory installed valve packages
- \* Oversized louvered wall panel (with captive screws)
- \* Condensate overflow switch
- \* Bottom return air kit
- \* 208/240-1 motor
- \* 277-1 motor



UNIT MODEL	NOMINAL CFM	DIMENSIONS			EST. SHIP WT.
		H	W	D	
4CW	400	40	22-1/8	15-1/8	90
6CW	600				95
8CW	800				100
10CW	1000				120
12CW	1200	43	22-1/8	18-1/8	140

#### NOTES:

1. See Page 25 for thermostats, and other accessories
2. Contact the factory for valve packages.



## CW-HW

### Vertical Closet or Wall Recessed Chilled Water - Hot Water (4-pipe)

#### Features:

- \* 3-speed, 24V control
- \* Front or bottom return kit (kit required for bottom return)
- \* 120V multi-speed motor
- \* Easily accessible throwaway filter
- \* Sloped thermoplastic drain pan
- \* Primary and secondary drains
- \* Can be hung on a closet wall (kit required)
- \* Installed manual air purge valve

#### Options:

- \* Factory installed valve packages
- \* Oversized louvered wall panel (with captive screws)
- \* Condensate overflow switch
- \* Bottom return air kit
- \* 208/240-1 motor
- \* 277-1 motor



UNIT MODEL	NOMINAL CFM	DIMENSIONS			EST. SHIP WT.
		H	W	D	
4CW-HW	400	43	22-1/8	18-1/8	90
6CW-HW	600				95
8CW-HW	800				100
10CW-HW	1000				120
12CW-HW	1200	43	22-1/8	21-1/8	140

#### NOTES:

1. See Page 25 for thermostats, and other accessories
2. Contact the factory for valve packages.





# CWE

## Vertical Closet or Wall Recessed Chilled Water - With Electric Heat

### Features:

- \* 3-speed, 24V control
- \* 0 - 10 kW electric heat
- \* 240V multi-speed motor
- \* Easily accessible throwaway filter
- \* Sloped thermoplastic drain pan
- \* Primary and secondary drains
- \* Can be hung on a closet wall (kit required)
- \* Coil connections stub out top of unit
- \* Electrical service pullout
- \* Various optional factory installed valve packages

### Options:

- \* Factory installed valve packages
- \* Oversized louvered wall panel (with captive screws)
- \* Closet hanger bracket
- \* Bottom return air kit
- \* 208-1 motor
- \* 277-1 motor

UNIT MODEL	NOMINAL CAPACITY (TONS)	kW (HEAT)	DIMENSIONS			EST. SHIP. WT.
			H	W	D	
4CWE0, 1, 2 4CWE3, 4	1.0	0, 1, 2 3, 4	40	22-1/8	15-1/8	90
6CWE0, 2, 3 6CWE4, 5, 6	1.5	0, 2, 3 4, 5, 6				95
8CWE0, 3, 4 8CWE5, 6, 8	2.0	0, 3, 4 5, 6, 8				100
10CWE0, 3, 5 10CWE6, 8, 10	2.5	0, 3, 5 6, 8, 10				120
12CWE0, 3, 5 12CWE6, 8, 10	3.0	0, 3, 5 6, 8, 10	43	22-1/8	18-1/8	140

### NOTES:

1. See Page 25 for thermostats and other accessories
2. Contact the factory for valve packages.



# MB

## Vertical / Horizontal Air Handler Chilled Water / Hot Water (2-pipe)

### Features:

- \* Copper tube aluminum fin coils
- \* Factory installed filter
- \* 120V motor - no controls
- \* Direct drive motor
- \* Horizontal drain pan
- \* Painted cabinet

### Options:

- \* 3-speed, 24V control (contact factory)
- \* 208/240-1 motor
- \* 277-1 motor

UNIT MODEL	NOMINAL CAPACITY (TONS)	DIMENSIONS			EST. SHIP. WT.
		H	W	D	
8MB	1.0-2.0	40	20	20	105
12MB	2.5-3.0	42	20	23	150
16MB	3.5-4.0	48	21-1/4	28	195
20MB	5.0	48	21-1/4	28	260

### NOTES:

1. See Page 25 for thermostats and other accessories.



VALVES for field installation. Recommended valve package per coil: 1 valve body, 1 power head and 2 hand valves					
	PART NO	DESCRIPTION	SIZE	Cv	USE ON UNIT SIZE
VALVE BODIES	E421317	2-WAY VALVE BODY	3/4"	7.0	8-12
	E421417	2-WAY VALVE BODY	1"	7.0	16-20
	E431317	3-WAY VALVE BODY	3/4"	7.0	8-12
	E431417	3-WAY VALVE BODY	1"	7.0	16-20
POWER HEADS	E501 SERIES	24V, 120V, 230V, 277V	---	---	ALL
HAND VALVES	CP90	COMBINATION BALANCE / SHUT-OFF	3/4"	---	8-12
	CP905	COMBINATION BALANCE / SHUT-OFF	1"	---	16-20
RELAY / TRANSFORMER	310-E301	120/240V RELAY / TRANSFORMER	---	---	ALL

### NOTES:

1. Power head leads are 18".
2. Valves must mount outside of cabinet (field installed).



# MB-HW

## Vertical / Horizontal Air Handler Chilled Water / Hot Water (4-pipe)

### Features:

- \* Copper tube heating and cooling coils
- \* Heating coil is down stream from blower
- \* Manual air bleed on hot water coil
- \* 120 multi-speed motor
- \* Direct drive motor
- \* Horizontal drain pan
- \* Painted cabinet
- \* Factory installed filter

### Options:

- \* 3-speed, 24V control (contact factory)
- \* 208/240-1 motor
- \* 277-1 motor

UNIT MODEL	NOMINAL CAPACITY (TONS)	BTUH (HEAT) @ 180°F EWT	DIMENSIONS			EST. SHIP WT.
			H	W	D	
8MB-2HW	1.0-2.0	41,700	40	20	20	105
8MB-3HW	1.0-2.0	53,200	40	20	20	105
10MB-3HW	2.5	72,200	42	20	23	140
12MB-3HW	3.0	84,900	42	20	23	155
16MB-4HW	4.0	127,400	48	21-1/4	28	210
20MB-4HW	5.0	154,500	52	25-1/4	28	270

### NOTES:

1. BTUH (heat) is calculated at 180°F EWT and nominal GPM.
2. See Page 25 for thermostats and other accessories.



### NOTES:

1. Power head leads are 18".
2. Valves must mount outside of cabinet (field installed).
3. MB-HW units require valves and power heads for both coils.

VALVES for field installation. Recommended valve package per coil: 1 valve body, 1 power head and 2 hand valves					
	PART NO	DESCRIPTION	SIZE	Cv	USE ON UNIT SIZE
VALVE BODIES	E421317	2-WAY VALVE BODY	3/4"	7.0	8-12 (and 8-16 htg. coil)
	E421417	2-WAY VALVE BODY	1"	7.0	16-20 (and 20 htg. coil)
	E431317	3-WAY VALVE BODY	3/4"	7.0	8-12 (and 8-16 htg. coil)
	E431417	3-WAY VALVE BODY	1"	7.0	16-20 (and 20 htg. coil)
POWER HEADS	E501 SERIES	24V, 120V, 230V, 277V	---	---	ALL
HAND VALVES	CP90	COMBINATION BALANCE / SHUT-OFF	3/4"	---	8-12 (and 8-16 htg. coil)
	CP905	COMBINATION BALANCE / SHUT-OFF	1"	---	16-20 (and 20 htg. coil)
RELAY / TRANSFORMER	310-E301	120/240V RELAY / TRANSFORMER	---	---	ALL

# MBE

## Vertical / Horizontal Air Handler Chilled Water - With Electric Heat

### Features:

- \* Copper tube aluminum fin coils
- \* Factory installed filter
- \* Painted cabinet
- \* Factory installed electric heat (except 0 kW)
- \* Circuit breaker service switch (above 10 kW)
- \* 240/24V relay/transformer
- \* Direct drive motor (2 speed)
- \* Horizontal drain pan
- \* 277V option available (U.L. listed)

### Options:

- \* 3-speed, 24V control (contact factory)
- \* 208/240-1 motor
- \* 277-1 motor

UNIT MODEL	NOMINAL CAPACITY (TONS)	kW (HEAT)	DIMENSIONS			EST. SHIP WT.
			H	W	D	
8MBE3,4,5,6 8MBE8,10	1.0-2.0	3, 4, 5, 6 8, 10	40	20	20	95
12MBE5 12MBE8,10 12MBE15	2.5-3.0	5 8, 10 15	42	20	23	138
16MBE 16MBE8,10 16MBE15,20,25	4.0	5 8, 10 15, 20, 25	48	21-1/4	23	195
20MBE5 20MBE8,10 20MBE15,20,25	5.0	5 8, 10 15, 20, 25	48	21-1/4	28	210

### NOTES:

1. See Page 25 for thermostats and other accessories.



VALVES for field installation. Recommended valve package per coil: 1 valve body, 1 power head and 2 hand valves					
	PART NO	DESCRIPTION	SIZE	Cv	USE ON UNIT SIZE
VALVE BODIES	E421317	2-WAY VALVE BODY	3/4"	7.0	8-12
	E421417	2-WAY VALVE BODY	1"	7.0	16-20
	E431317	3-WAY VALVE BODY	3/4"	7.0	8-12
	E431417	3-WAY VALVE BODY	1"	7.0	16-20
POWER HEADS	E501 SERIES	24V, 120V, 230V, 277V	---	---	ALL
HAND VALVES	CP90	COMBINATION BALANCE / SHUT-OFF	3/4"	---	8-12
	CP905	COMBINATION BALANCE / SHUT-OFF	1"	---	16-20

### NOTES:

1. Power head leads are 18".
2. Valves must mount outside of cabinet (field installed).

## VMB (ECM Variable Speed) Vertical / Horizontal Air Handler Chilled Water / Hot Water (2-pipe)

### Features:

- \* High efficiency variable speed motor
- \* Copper tube coils
- \* Factory installed filter
- \* 120/208/230-1 motor - 24V control
- \* Convertible horizontal drain pan

UNIT MODEL	NOMINAL CAPACITY (TONS)	DIMENSIONS			EST. SHIP. WT.
		H	W	D	
8VMB	1.0-2.0	40	20	20	120
12VMB	2.5-3.0	42	20	23	165
16VMB	3.5-4.0	48	21-1/4	28	210
20VMB	5.0	48	21-1/4	28	275

### NOTES:

1. See Page 25 for thermostats and other accessories.

VALVES for field installation. Recommended valve package per coil: 1 valve body, 1 power head and 2 hand valves					
	PART NO	DESCRIPTION	SIZE	Cv	USE ON UNIT SIZE
VALVE BODIES	E421317	2-WAY VALVE BODY	3/4"	7.0	8-12
	E421417	2-WAY VALVE BODY	1"	7.0	16-20
	E431317	3-WAY VALVE BODY	3/4"	7.0	8-12
	E431417	3-WAY VALVE BODY	1"	7.0	16-20
POWER HEADS	E501 SERIES	24V, 12-V, 230V, 277V	---	---	ALL
HAND VALVES	CP90	COMBINATION BALANCE / SHUT-OFF	3/4"	---	8-12
	CP905	COMBINATION BALANCE / SHUT-OFF	1"	---	16-20

### NOTES:

1. Power head leads are 18".
2. Valves must mount outside of cabinet (field installed).



## VMB-HW (ECM Variable Speed) Vertical / Horizontal Air Handler Chilled Water / Hot Water (4-pipe)

### Features:

- \* High efficiency variable speed motor
- \* Copper tube heating and cooling coils
- \* Heating coil is down stream from blower
- \* Manual air bleed on hot water coil
- \* 120/208/230-1 motor - 24V control
- \* Convertible horizontal drain pan
- \* Factory installed filter

UNIT MODEL	NOMINAL CAPACITY (TONS)	BTUH (HEAT @ 180°F EWT)	DIMENSIONS			EST. SHIP. WT.
			H	W	D	
8VMB-3HW	1.0-2.0	55,600	40	20	20	120
12VMB-3HW	2.5-3.0	84,600	42	20	23	170
16VMB-4HW	4.0	127,700	48	21-1/4	28	225
20VMB-4HW	5.0	156,200	52	25-1/4	28	285

### NOTES:

1. Cooling capacity is at 45°F EWT and highest GPM.
2. BTUH (heat) is calculated at 180°F EWT and nominal GPM.
3. See Page 25 for thermostats and other accessories.

VALVES for field installation. Recommended valve package per coil: 1 valve body, 1 power head and 2 hand valves					
	PART NO	DESCRIPTION	SIZE	Cv	USE ON UNIT SIZE
VALVE BODIES	E421317	2-WAY VALVE BODY	3/4"	7.0	8-12 (and 8-16 hgt. coil)
	E421417	2-WAY VALVE BODY	1"	7.0	16-20 (and 20 hgt. coil)
	E431317	3-WAY VALVE BODY	3/4"	7.0	8-12 (and 8-16 hgt. coil)
	E431417	3-WAY VALVE BODY	1"	7.0	16-20 (and 20 hgt. coil)
POWER HEADS	E501 SERIES	24V, 120V, 230V, 277V	---	---	ALL
HAND VALVES	CP90	COMBINATION BALANCE / SHUT-OFF	3/4"	---	8-12 (and 8-16 hgt. coil)
	CP905	COMBINATION BALANCE / SHUT-OFF	1"	---	16-20 (and 20 hgt. coil)

### NOTES:

1. Power head leads are 18".
2. Valves must mount outside of cabinet (field installed).
3. VMB-HW units require valves and power heads for both coils.



## VMBE (ECM Variable Speed) Vertical / Horizontal Air Handler Chilled Water - With Electric Heat

### Features:

- \* High efficiency variable speed motor
- \* Copper tube coils
- \* Factory installed filter
- \* Factory installed electric heat (except 0 kW)
- \* Circuit breaker service switch (above 10 kW)
- \* 240/208-1 motor - 24V control
- \* Convertible horizontal drain pan

UNIT MODEL	NOMINAL CAPACITY (TONS)	CFM	kW (HEAT)	DIMENSIONS			EST. SHIP. WT.
				H	W	D	
8VMBE3,4,5,6 8VMBE8,10	1.0-2.0	600-800	3,4,5,6 8,10	40	20	20	95
12VMBE5 12VMBE8,10 12VMBE15	2.5-3.0	1000-1200	5 8,10 15	42	20	23	138
16VMBE5 16VMBE8,10 16VMBE15,20,25	4.0	1400-1600	5 8,10 15,20,25	48	21-1/4	28	195
20VMBE5 20VMBE8,10 20VMBE15,20,25	5.0	1600-2000	5 8,10 15,20,25	48	21-1/4	28	210

### NOTES:

1. See Page 25 for thermostats and other accessories.

### VALVES for field installation.

Recommended valve package per coil: 1 valve body, 1 power head and 2 hand valves

	PART NO	DESCRIPTION	SIZE	Cv	USE ON UNIT SIZE
VALVE BODIES	E421317	2-WAY VALVE BODY	3/4"	7.0	8-12
	E421417	2-WAY VALVE BODY	1"	7.0	16-20
	E431317	3-WAY VALVE BODY	3/4"	7.0	8-12
	E431417	3-WAY VALVE BODY	1"	7.0	16-20
POWER HEADS	E501 SERIES	24V, 120V, 230V, 277V	---	---	ALL
HAND VALVES	CP90	COMBINATION BALANCE / SHUT-OFF	3/4"	---	8-12
	CP905	COMBINATION BALANCE / SHUT-OFF	1"	---	16-20

### NOTES:

1. Power head leads are 18".
2. Valves must mount outside of cabinet (field installed).



## VCB, VFB, VSB, WCB

### Floor Consoles Chilled / Hot Water

### Features:

- \* Concealed model - **VCB**
- \* Flat Top - **VFB**
- \* Slope Top - **VSF**
- \* Recessed Wall - **WCB** (includes wall panel)
- \* Attractive painted cabinet (VFB, VSB only)
- \* Electrical service switch
- \* Multi-speed motors (120V)
- \* Copper tube coils
- \* Manual air vents
- \* Permanent filter
- \* Super quiet operation
- \* 277V option available
- \* 220V, 50Hz models available

UNIT MODEL	SIZE	NOMINAL CFM	AVAILABLE COIL CONFIGURATION	DIMENSIONS			EST. SHIP. WT.
				H	W	D	
VCB/ WCB	3	300		24-1/2	40-1/4	9-1/4	90
	4	400	3-ROW	24-1/2	48-1/4	9-1/4	90
	6	600	4-ROW	24-1/2	56-1/4	9-1/4	90
	8	800	3 COOL, 1 HEAT	24-1/2	64-1/4	9-1/4	115
	10	1000	4 COOL, 1 HEAT <sup>(1)</sup>	24-1/2	72-1/4	9-1/4	130
12	1200		24-1/2	80-1/4	9-1/4	130	
VFB	3	300		25	43	9-1/4	90
	4	400	3-ROW	25	51	9-1/4	90
	6	600	4-ROW	25	59	9-1/4	90
	8	800	3 COOL, 1 HEAT	25	67	9-1/4	115
	10	1000	4 COOL, 1 HEAT <sup>(1)</sup>	25	75	9-1/4	130
12	1200		25	83	9-1/4	130	
VSB	3	300		27-5/8	43	9-1/4	95
	4	400	3-ROW	27-5/8	51	9-1/4	95
	6	600	4-ROW	27-5/8	59	9-1/4	95
	8	800	3 COOL, 1 HEAT	27-5/8	67	9-1/4	120
	10	1000	4 COOL, 1 HEAT <sup>(1)</sup>	27-5/8	75	9-1/4	135
12	1200		27-5/8	83	9-1/4	138	

### NOTES:

1. Size 10 and 12, 4/1 split not available (4 row max.).
2. Contact factory for such options as unit mounted thermostat with 3 speed switch, valve packages, air dampers, etc.



# Vertical High-Rise

## RR-Series

(300 - 1200 CFM)

Vertical - Hydronic

Chilled water / Hot water / Electric Heat

### Features:

- \* 18 gauge galvanized steel frame and back panel
- \* 3/4" thick antimicrobial coated Tuf-skin RX fiberglass insulation
- \* Powder coated optional stamped louver return air grille panel
- \* Galvanized steel drain pan coated inside with closed-cell foam insulation
- \* 1" filter track with 1" TA filter
- \* DWDI forward curve blower wheels statically and dynamically balanced
- \* Coils are 1'2" copper tube with mechanically bonded aluminum fins
- \* 2-pipe and 4-pipe coil options
- \* Coil working pressure to 350 PSI
- \* Manual air vents
- \* Standard factory mounted piping risers are 115" long with 3" belled ends
- \* Risers are type M copper insulated with 1/2 closed cell insulation
- \* Various valve and actuator options
- \* Standard unit is 115/1/60 power supply
- \* Standard unit includes 3-speed fan board 120/24V

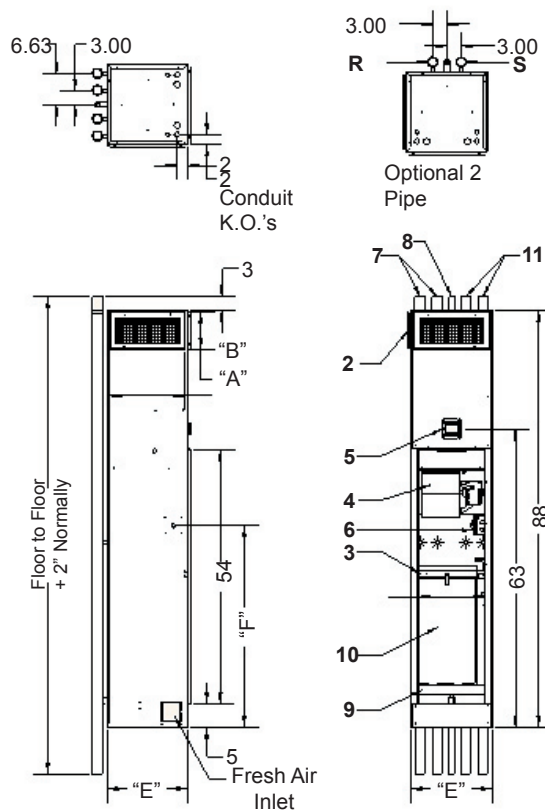

MODEL	SINGLE SUPPLY			DOUBLE SUPPLY			TOP SUPPLY			E	F	G	FILTER SIZE
	A	B	SIZE	A	B	SIZE	C	D	SIZE				
RRA300	14	8	14 X 8	14	6	14X6	14	10	14 X 10	17	42.62	14.13	12.5 X 24.25 X 1
RRA400	14	12	14 X 12	14	6	14X6	14	10	14 X 10	17	42.62	14.13	12.5 X 24.25 X 1
RRA600	18	10	18 X 10	18	6	18X6	16	12	16 X 12	20	42.62	18.13	16.25 X 26.75 X 1
RRA800	18	12	18 X 12	18	6	18X6	16	12	16 X 12	20	42.62	18.13	16.25 X 26.75 X 1
RRA1000	---	---	---	22	8	22X8	18	16	18 X 16	24	42.62	22.13	20.50 X 29.25 X 1
RRA1200	---	---	---	23	8	22X8	18	16	18 X 16	24	42.62	22.13	20.50 X 29.25 X 1

# Vertical High-Rise

## RM/RS-Series

(300 - 1200 CFM)

Master Unit / Slave Unit

Vertical - Hydronic

Chilled water / Hot water / Electric Heat

### Features:

- \* 18 gauge galvanized steel frame and back panel
- \* 3/4" thick antimicrobial coated Tuf-skin RX fiberglass insulation
- \* Powder coated optional stamped louver return air grille panel
- \* Galvanized steel drain pan coated inside with closed-cell foam insulation
- \* 1" filter track with 1" TA filter
- \* DWDI forward curve blower wheels statically and dynamically balanced
- \* Coils are 1"2" copper tube with mechanically bonded aluminum fins
- \* 2-pipe and 4-pipe coil options
- \* Coil working pressure to 350 PSI
- \* Manual air vents
- \* Standard factory mounted piping risers are 115" long with 3" belled ends
- \* Risers are type M copper insulated with 1/2 closed cell insulation
- \* Various valve and actuator options
- \* Standard unit is 115/1/60 power supply
- \* Standard unit includes 3-speed fan board 120/24V

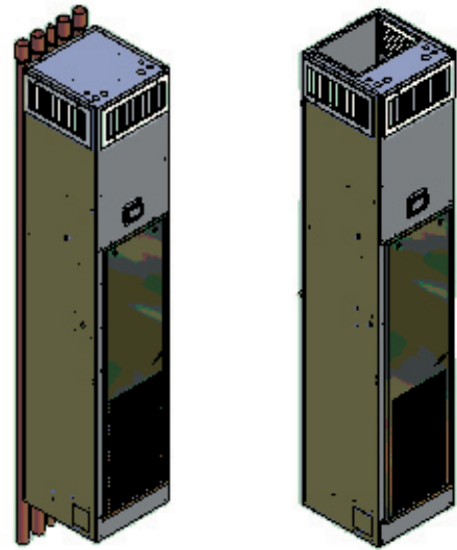

Master

Slave

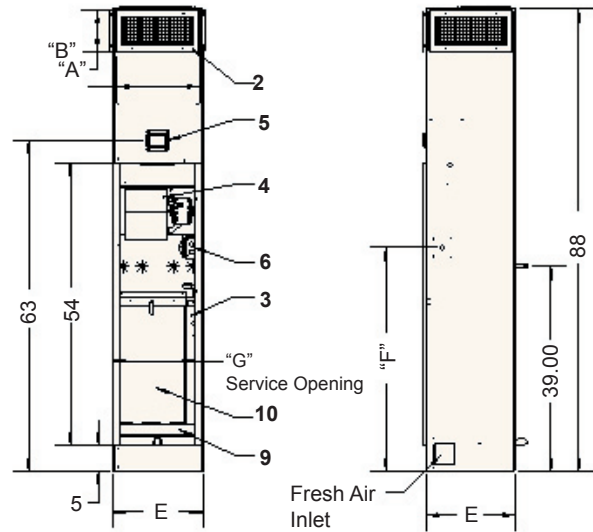
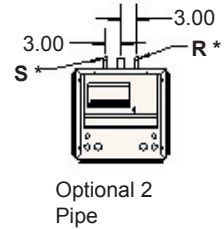
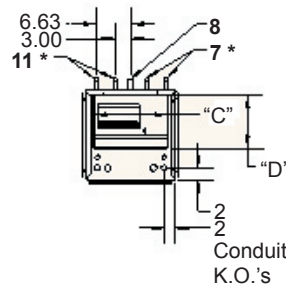

MODEL	SINGLE SUPPLY			DOUBLE SUPPLY			TOP SUPPLY			E	F	G	FILTER SIZE
	A	B	SIZE	A	B	SIZE	C	D	SIZE				
RMA300	14	8	14 X 8	14	6	14X6	14	10	14 X 10	17	42.62	14.13	12.5 X 24.25 X 1
RMA400	14	12	14 X 12	14	6	14X6	14	10	14 X 10	17	42.62	14.13	12.5 X 24.25 X 1
RMA600	18	10	18 X 10	18	6	18X6	16	12	16 X 12	20	42.62	18.13	16.25 X 26.75 X 1
RMA800	18	12	18 X 12	18	6	18X6	16	12	16 X 12	20	42.62	18.13	16.25 X 26.75 X 1
RMA1000	---	---	---	22	8	22X8	18	16	18 X 16	24	42.62	22.13	20.50 X 29.25 X 1
RMA1200	---	---	---	23	8	22X8	18	16	18 X 16	24	42.62	22.13	20.50 X 29.25 X 1

# WH Double Wall (600 - 10,000 CFM)

Belt Drive Blower - Coil  
Horizontal - Hydronic

## Features:

- \* 1" Double wall post and panel construction
- \* Minimum of 18 gauge galvanized steel material
- \* 1" 1.5lb density fiberglass insulation
- \* 1/2" OD copper tube coil
- \* Three-way sloped IAQ drain pans UL94-5V rated
- \* DWDI forward curved fan wheels
- \* ODP belt drive motors w/automatic reset thermal protection
- \* Motors factory installed
- \* Motor wiring harness terminating in factory mounted 4x4 j-box
- \* Manual air vents
- \* Gasketed access panels
- \* Internal rubber-in-compression isolators
- \* Tool free access panel fasteners
- \* 2" Pleated Merv 7 filters
- \* Base mount motor assembly
- \* Hydronic coils tested at 350 pounds air pressure for 300 PSI gauge working pressure

## Options

- \* Coils are available with 2 circuit options
- \* 1, 2, 4, or 6 row coils, total of 10 rows
- \* Stainless steel IAQ drain pan
- \* Electric heat-Discharge mounted
- \* Spring isolator kits
- \* Motor control box
- \* Motor control starters
- \* 4" Flat filter section
- \* 2" or 4" angled filter section (4" not available for size 8 or 12)
- \* Mixing box
- \* TEFC motors
- \* 2-speed motors
- \* Voltage options: 120/208/240-1 phase  
208/240/460-3 phase  
277-1 phase
- \* HP's from 1/3 to 10 available

UNIT MODEL	NOM. CFM	DIMENSIONS			EST. SHIP. WT.
		H	W	D	
8WH	800	19	32-1/4	53-1/4	295
12WH	1200	19	36-1/4	53-1/4	320
16WH	1600	21-1/2	40-1/4	53-1/4	361
20WH	2000	21-1/2	46-1/4	53-1/4	402
30WH	3000	34	46-1/4	66-1/8	
40WH	4000	34	57-1/4	66-1/8	
60WH	6000	44	66-1/4	75-1/4	
80WH	8000	58-1/2	66-1/4	75-1/4	

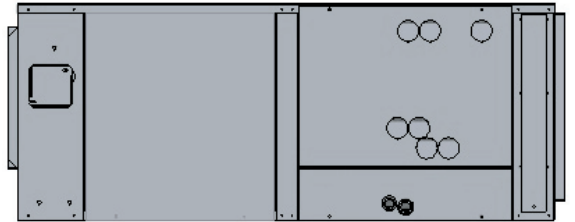
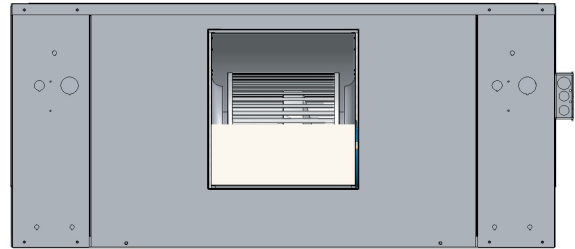

8-40WH

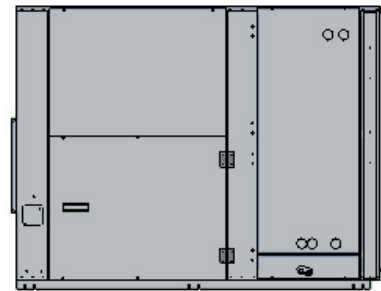
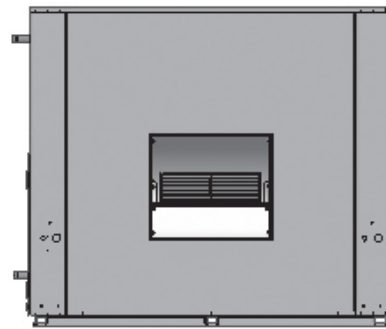

60-80WH



# XH Double Wall (600 - 10,000 CFM)

Belt Drive Blower - Coil

Horizontal - **DX**

(Hot Water or Electric Heat)

(R22 & R-410A)

UNIT MODEL	NOM. CFM	DIMENSIONS			EST. SHIP. WT.
		H	W	D	
8XH	800	19	32-1/4	53-1/4	295
12XH	1200	19	36-1/4	53-1/4	320
16XH	1600	21-1/2	40-1/4	53-1/4	361
20XH	2000	21-1/2	46-1/4	53-1/4	402
30XH	3000	34	46-1/4	66-1/8	
40XH	4000	34	57-1/4	66-1/8	
60XH	6000	44	66-1/4	75-1/4	
80XH	8000	58-1/2	66-1/4	75-1/4	

## Features:

- \* 1" Double wall post and panel construction
- \* Minimum of 18 gauge galvanized steel material
- \* 1" 1.5lb density fiberglass insulation
- \* 1/2" OD copper tube HW coil
- \* 3/8" OD copper tube DX coil
- \* Three-way sloped IAQ drain pans UL94-5V rated
- \* DWDI forward curved fan wheels
- \* ODP belt drive motors w/automatic reset thermal protection
- \* Motors factory installed
- \* Motor wiring harness terminating in factory mounted 4x4 j-box
- \* Straight cool or heat Pump with factory mounted TXV's, sizes 08-20 (2-5 Ton)
- \* Straight cool with factory mounted TXV's, sizes 30-80 (Contact factory for heat Pump applications)
- \* Sizes 08-30 (2-7.5 Ton) are standard with single circuit coils
- \* Sizes 40-80 (10-20 Ton) are standard with dual circuit face-split coils
- \* Manual air vents standard on hw coils
- \* Gasketed access panels
- \* Internal rubber-in-compression isolators
- \* Tool free access panel fasteners
- \* 2" Pleated Merv 7 filters
- \* Base mount motor assembly
- \* Hydronic coils tested at 350 pounds air pressure for 300 PSI gauge working pressure

## Options

- \* Hydronic 1 or 2 row hot water coil
- \* Stainless steel IAQ drain pan
- \* Electric heat (field mounted)
- \* Spring isolator kits
- \* Motor control box
- \* Motor control starters
- \* 4" Flat filter section
- \* 2" or 4" angled filter section (4" not available for size 8 or 12)
- \* Mixing box
- \* TEFC motors
- \* 2-speed motors
- \* Voltage options: 120/208/240-1 phase  
208/240/460-3 phase  
277-1 phase
- \* HP's from 1/3 to 10 available

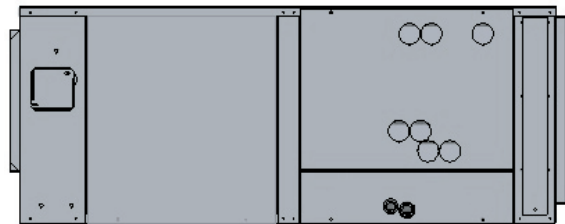
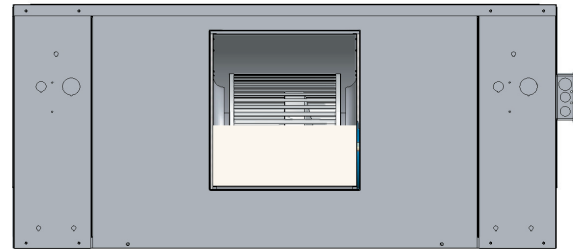

8-40XH

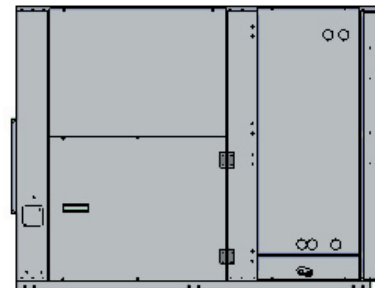
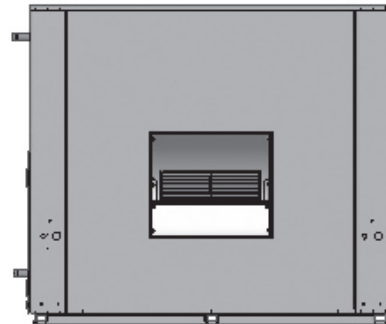

60-80XH





## SHW Single Wall (600-10,000 CFM)

Belt Drive Blower - Coil  
**Horizontal - Hydronic**

### Features:

- \* All motors are factory installed
- \* Sloped and insulated drain pan
- \* Galvanized steel cabinet
- \* Insulation meets IAQ standards
- \* Manual air vents
- \* Hanger brackets (2 - 5 ton only)
- \* Adjustable sheaves
- \* Various motor options
- \* Factory installed filters

### Options

- \* 7 Day Quick Ship
- \* Motor control box
- \* Hot water coils
- \* Electric heat (field mounted)
- \* Vibration isolators

UNIT MODEL	CFM	DIMENSIONS			EST. SHIP. WT.
		H	W	D	
24SHW (4 or 6-Row)	600-1000	18-7/8	37	32-1/2	205
36SHW	1000-1400	18-7/8	37	42	225
48SHW	1400-1800	22-7/8	39	43-1/2	265
60SHW	1800-2200	22-7/8	42	50-1/2	310
90SHW	2500-3500	27	52-1/2	54	475
120SHW	3400-4600	32	52-1/2	57	535
180SHW	5200-6800	39-1/2	56-1/2	66	710
240SHW	6000-10000	52	62-1/2	66	880

### NOTES:

1. Contact factory for optional motors.
2. Contact factory for **electric heat** information



## SVW Single Wall (600-10,000 CFM)

Belt Drive Blower - Coil  
**Vertical - Hydronic**

### Features:

- \* All motors are factory installed
- \* Sloped and insulated drain pan
- \* Galvanized steel cabinet
- \* Insulation meets IAQ standards
- \* Adjustable sheaves
- \* Factory installed filters
- \* Manual air vents
- \* Various motor options

### Options

- \* 7 Day Quick Ship
- \* Motor control box
- \* Hot water coils
- \* Electric heat (field mounted)
- \* Vibration isolators

UNIT MODEL	CFM	DIMENSIONS			EST. SHIP. WT.
		H	W	D	
24SVW (4 or 6-Row)	600-1000	35-1/8	28-1/2	31-1/4	205
36SVW	1000-1400	35-1/8	38	31-1/4	225
48SVW	1400-1800	41-7/8	39-1/2	31-1/4	265
60SVW	1800-2200	43-1/8	46-1/2	31-1/4	310
90SVW	2500-3500	51	55-1/2	37-1/2	475
120SVW	3400-4600	56	58-1/2	37-1/2	535
180SVW	5200-6800	63-1/8	66	46-1/4	710
240SVW	6000-10000	75-1/2	66	46-1/4	880

### NOTES:

1. Contact factory for optional motors.
2. Contact factory for **electric heat** information

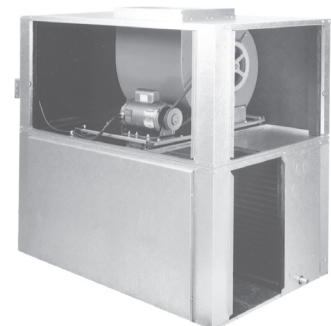
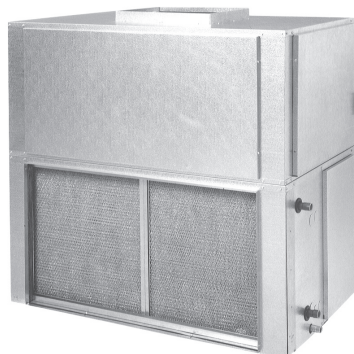

## SHX Single Wall

(600-10,000 CFM)

Belt Drive Blower - Coil

**Horizontal - Direct Expansion**

R22 or R410a

### Features:

- \* All motors are factory installed
- \* Sloped and insulated drain pan
- \* Galvanized steel cabinet
- \* Insulation meets IAQ standards
- \* Bi-directional expansion valves for heat pump or standard cooling (2 - 5 ton only)
- \* Expansion valves for DX only (7-1/2 - 20 ton models)
- \* Various motor options & voltages
- \* Factory installed filters
- \* Adjustable sheaves
- \* Hanger brackets (2 - 5 ton only)

### Options

- \* 7 Day Quick Ship
- \* Motor control box
- \* Hot water coils
- \* Electric heat (field mounted)
- \* Vibration isolators



UNIT MODEL	CFM	DIMENSIONS			EST. SHIP. WT.
		H	W	D	
24SHX4	600-1000	18-7/8	37	32-1/2	185
36SHX4	1000-1400	18-7/8	37	42	205
48SHX4	1400-1800	22-7/8	39	43-1/2	240
60SHX4	1800-2200	22-7/8	42	50-1/2	290
90SHX4	2500-3500	27	52-1/2	54	450
120SHX4	3400-4600	32	52-1/2	57	490
180SHX4	5200-6800	39-1/2	56-1/2	66	680
240SHX4	6000-10000	52	62-1/2	66	835

### NOTES:

1. Contact factory for optional motors.
2. Contact factory for **electric heat** information
3. 24-90SHX have single circuit coil. 120-240SHX have dual circuit coils.



## SVX Single Wall

(600-10,000 CFM)

Belt Drive Blower - Coil

**Vertical - Direct Expansion**

R22 or R410a

### Features:

- \* All motors are factory installed
- \* Sloped and insulated drain pan
- \* Galvanized steel cabinet
- \* Insulation meets IAQ standards
- \* Adjustable sheaves
- \* Various motor options
- \* Bi-directional expansion valves for heat pump or standard cooling (2 - 5 ton only)

### Options

- \* 7 Day Quick Ship
- \* Motor control box
- \* Hot water coils
- \* Electric heat (field mounted)
- \* Vibration isolators



UNIT MODEL	CFM	DIMENSIONS			EST. SHIP. WT.
		H	W	D	
24SVX4	600-1000	35-1/8	28-1/2	31-3/4	195
36SVX4	1000-1400	35-1/8	38	31-3/4	225
48SVX4	1400-1800	41-7/8	39-1/2	31-3/4	265
60SVX4	1800-2200	43-1/8	46-1/2	31-3/4	345
90SVX4	2500-3500	51	55-1/2	37-1/2	460
120SVX4	3400-4600	56	58-1/2	37-1/2	575
180SVX4	5200-6800	63-1/8	66	46-1/6	805
240SVX4	6000-10000	75-1/2	66	46-1/4	920

### NOTES:

1. Contact factory for optional motors.
2. Contact factory for **electric heat** information
3. 24-90SVX have single circuit coils. 120-240SVX have dual circuit coils.

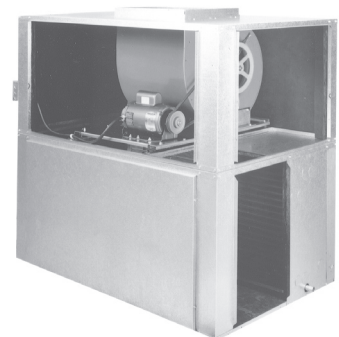
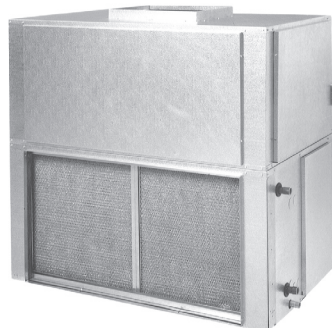

## Optional Accessories for SHW/SHX/SVW/SVX Blower Coils

DESCRIPTION	PART NUMBER	FOR	FACTORY OR FIELD INSTALLED	EST. SHIP WT.
HOT WATER (1) COILS	24HWK	Size 24	FACTORY OR FIELD INSTALLED	15
	36HWK	Size 36		20
	48HWK	Size 48		27
	60HWK	Size 60		32
	90HWK	Size 90		43
	120HWK	Size 120		55
	180HWK	Size 180	88	
	240HWK	Size 240	---	
PERMANENT FILTERS (3)	975-1	Size 24	FACTORY INSTALLED	---
	975-2	Size 36		---
	975-3	Size 48		---
	975-4	Size 60		---
DISCHARGE PLENUM/GRILLE	24DP	24SHW/SHX	FIELD INSTALLED	20
	36DP	36SHW/SHX		24
	48DP	48SHW/SHX		27
	60DP	60SHW/SHX		31
	90DP	90SHW/SHX		---
	120DP	120SHW/SHX		---
	180DP	180SHW/SHX		---
	240DP	240SHW/SHX		---
MIXING BOXES	24MB	Size 24	FIELD INSTALLED	43
	36MB	Size 36		60
	48MB	Size 48		65
	60MB	Size 60		75
	90MB	Size 90		115
	120MB	Size 120		131
	180MB	Size 180		196
	240MB	Size 240		210
MOTOR CONTROLS	PAGE 22			

**ELECTRIC HEAT (DISCHARGE MTD)  
SEE PAGE 20-21**

**SPRING ISOLATORS  
SEE PAGE 22**

**NOTES:**

1. Reheat position for hot water coils is standard. For preheat, please specify.
2. Factory installed options must be specified at time of order entry.
3. Contact factory for pleated filters.

## SHW-DD Single Wall (800-2000 CFM)

Horizontal - Hydronic (2-Pipe only)  
Direct Drive Blower Coil

**Features:**

- \* All motors are factory installed
- \* Sloped and insulated drain pan
- \* Galvanized steel cabinet
- \* Insulation meets IAQ standards
- \* Manual air vents
- \* Hanger brackets
- \* Factory installed filters
- \* 115V, direct drive, multi-speed motors

**Options**

- \* See Page 18 for accessories

UNIT MODEL	NOMINAL CFM	HP/ VOLTAGE/ PHASE (STANDARD)	DIMENSIONS			EST. SHIP. WT.
			H	W	D	
24SHW4-DD	800	1/5-115-1	18-7/8	37	31	210
36SHW4-DD	1200	1/3-115-1	18-7/8	37	40-1/2	280
48SHW4-DD	1600	1/2-115-1	22-7/8	39	42	305
60SHW4-DD	2000	3/4-115-1	22-7/8	42	49	420

**NOTES:**

1. These direct drive units can handle E.S.P. up to .60
2. 2-pipe, 4-row only.



## Electric Heat for SHW / SVW Belt Drive Products

SINGLE POINT CONNECTION (CONTACTOR AND TERMINAL BOARD)  
 PRIMARY AND SECONDARY CONTACTOR (DE-ENERGIZING)  
 AUTO AND MANUAL LIMIT SWITCH (PILOT DUTY)  
 HIGH NICKEL CHROME ALLOY RESISTANCE WIRE

HIGH AND LOW VOLTAGE TERMINAL BOARD  
 TRANSFORMER (S4 VOLT SECONDARY)  
 AIRFLOW SWITCH (NON ADJUSTABLE)  
 POWER FUSING (PER NEC)

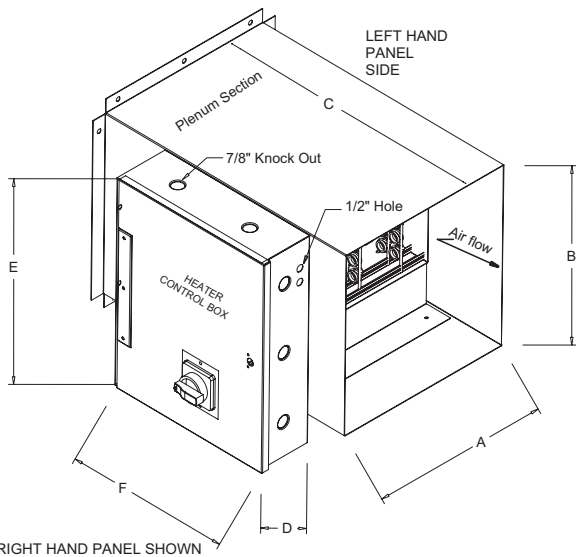

MUST SPECIFY  
 IF UNITS ARE  
 HORIZONTAL OR  
 VERTICAL AND WITH  
 LEFT HAND OR RIGHT  
 HAND CONNECTIONS

### OPTIONS

NON-FUSED DISCONNECT  
 80/20 WIRE  
 STAINLESS TERMINALS  
 \*\*MULTIPLE STAGES  
 \*\*SCR CONTROL  
 \*\*STEP CONTROLLER  
 WALL STAT  
 DUCT STAT

### NOTE

\*\*CONTACT FACTORY FOR  
 THESE OPTIONS.  
 Options not available on  
 all heaters

MODELS	UNIT SIZE	DESIGNATION	A	B	C	D	E	F
SH/SV	24 (2-TON)	25	9.7	11.1	14	5.5	17	11.5
SH/SV	36 (3-TON)	36	12.7	11.1	14	5.5	17	11.5
SH/SV	48 (4-TON)	48	14	12.2	14	5.5	21	11.5
SH/SV	60 (5-TON)	61	16.4	14.2	14	5.5	21	11.5
SH/SV	90 (7.5-TON)	90	19.5	16.6	14	5.5	26	11.5
SH/SV	120 (10-TON)	120	19.5	16.7	14	5.5	30	11.5
SH/SV	180 (15-TON)	180	---	---	---	---	---	---
SH/SV	240 (20-TON)	240	---	---	---	---	---	---

### HEATER NOMENCLATURE

HEATER	UNIT DESIGNATION				KW		HEATER STAGES		VOLTAGE		NF-DISCONNECT		OPT. ACCYS.	
	SINGLE WALL UNIT SIZE	CODE	DOUBLE WALL UNIT SIZE	CODE	KW	CODE	STAGES	CODE	I-PHASE	CODE	TOTAL AMPS	CODE	ACCYS.	CODE
H	24 (2 TON)	25	08 (2 TON)	08	1KW	1	1 STAGE	1	208V	01	40 AMP	A	NO ACCYS.	N
	36 (3 TON)	36	12 (3 TON)	12	2KW	2	2 STAGE	2	220V	21	80 AMP	B	J-BOX CONDUIT	J
	48 (4 TON)	48	16 (4 TON)	16	3KW	3	3 STAGE	3	240V	41	100 AMP	C	INSULATED PANEL	I
	60 (5 TON)	61	20 (5 TON)	20	1.5KW	4	SCR	M	277V	71	125 AMP	D		
	90 (7.5 TON)	90	30 (7.5 TON)	30	2.7KW	5			3-PHASE	CODE	NO DISCONNECT	N		
	120 (10 TON)	120	40 (10 TON)	40	15KW	15			208V	03				
	180 (15 TON)	180	60 (15 TON)	60					240V	43				
240 (20 TON)	240	80 (20 TON)	80					380V	83					
									460V	63				

H	48	5	1	41	A
---	----	---	---	----	---

EXAMPLE: MODEL # H485151A  
 DESCRIPTION: 48 (4 TON) 5KW 1 STAGE 240V/1PH 40 AMP NON-FUSED DISCONNECT

## Electric Heat for WHD / XHD Belt Drive Products

SINGLE POINT CONNECTION (CONTACTOR AND TERMINAL BOARD)  
 PRIMARY AND SECONDARY CONTACTOR (DE-ENERGIZING)  
 AUTO AND MANUAL LIMIT SWITCH (PILOT DUTY)  
 HIGH NICKEL CHROME ALLOY RESISTANCE WIRE

HIGH AND LOW VOLTAGE TERMINAL BOARD  
 TRANSFORMER (S4 VOLT SECONDARY)  
 AIRFLOW SWITCH (NON ADJUSTABLE)  
 POWER FUSING (PER NEC)

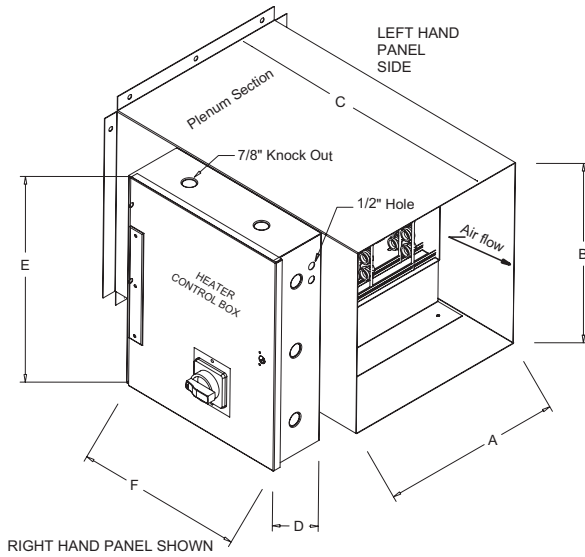

MUST SPECIFY  
 IF UNITS ARE  
 HORIZONTAL OR  
 VERTICAL AND WITH  
 LEFT HAND OR RIGHT  
 HAND CONNECTIONS

### OPTIONS

NON-FUSED DISCONNECT  
 80/20 WIRE  
 STAINLESS TERMINALS  
 \*\*MULTIPLE STAGES  
 \*\*SCR CONTROL  
 \*\*STEP CONTROLLER  
 WALL STAT  
 DUCT STAT

### NOTE

\*\*CONTACT FACTORY FOR  
 THESE OPTIONS.  
 Options not available on  
 all heaters



MODELS	UNIT SIZE	DESIGNATION	A	B	C	D	E	F
WHD/XHD	08 (2-TON)	08	7.5	11.1	14	5.5	17	11.5
WHD/XHD	12 (3-TON)	12	9.1	11.1	14	5.5	17	11.5
WHD/XHD	16 (4-TON)	16	10.2	12.2	14	5.5	19	11.5
WHD/XHD	20 (5-TON)	20	13.1	14.2	14	5.5	19	11.5
WHD/XHD	30 (7.5-TON)	30	15.3	16.7	14	5.5	24	11.5
WHD/XHD	40 (10-TON)	40	19.3	16.7	14	5.5	24	11.5
WHD/XHD	60 (15-TON)	60	22.5	19.3	14	5.5	30	11.5
WHD/XHD	80 (20-TON)	80	22.5	19.3	14	5.5	30	11.5



### HEATER NOMENCLATURE

HEATER	UNIT DESIGNATION				KW		HEATER STAGES		VOLTAGE		NF-DISCONNECT		OPT. ACCYS.	
	SINGLE WALL UNIT SIZE	CODE	DOUBLE WALL UNIT SIZE	CODE	KW	CODE	STAGES	CODE	I-PHASE	CODE	TOTAL AMPS	CODE	ACCYS.	CODE
H	24 (2 TON)	25	08 (2 TON)	08	1KW	1	1 STAGE	1	208V	01	40 AMP	A	NO ACCYS.	N
	36 (3 TON)	36	12 (3 TON)	12	2KW	2	2 STAGE	2	220V	21	80 AMP	B	J-BOX CONDUIT	J
	48 (4 TON)	48	16 (4 TON)	16	3KW	3	3 STAGE	3	240V	41	100 AMP	C	INSULATED PANEL	I
	60 (5 TON)	61	20 (5 TON)	20	1.5KW	4	SCR	M	277V	71	125 AMP	D		
	90 (7.5 TON)	90	30 (7.5 TON)	30	2.7KW	5			3-PHASE	CODE	NO DISCONNECT	N		
	120 (10 TON)	120	40 (10 TON)	40	15KW	15			208V	03				
	180 (15 TON)	180	60 (15 T ON)	60					240V	43				
	240 (20 TON)	240	80 (20 TON)	80					380V	83				
								460V	63					

EXAMPLE: MODEL # H085141A  
 DESCRIPTION: 08 (2 TON DOUBLE WALL) 5KW 1 STAGE 240V/1PH 40 AMP NON-FUSED DISCONNECT

**SPRING ISOLATOR KITS FOR BELT DRIVE PRODUCTS**

<b>NON-SEISMIC Hanger Selections for Ceiling Suspended Units</b>						
<b>SHW/SHX-HORIZONTAL SPRING ISOLATORS</b>						
						
UNIT MODEL NUMBER	HANGER		HANGER		HANGER	
	QTY & SIZE		QTY & SIZE		QTY & SIZE	
<b>HORIZONTAL FAN &amp; COIL SECTION - 4 ROW COIL</b>						
24 SHW	FVI-1	4-X	FVI-7	4-X	FVI-13	4-A
36 SHW	FVI-1	4-X	FVI-7	4-X	FVI-13	4-A
48 SHW	FVI-2	4-X	FVI-8	4-X	FVI-13	4-A
60 SHW	FVI-2	4-X	FVI-8	4-X	FVI-13	4-A
90 SHW	FVI-3	4-X	FVI-9	4-X	FVI-14	4-B
120 SHW	FVI-3	4-X	FVI-9	4-X	FVI-14	4-B
180 SHW	FVI-4	4-A	FVI-10	4-A	FVI-15	4-B
240 SHW	FVI-5	4-A	FVI-11	4-A	FVI-15	4-B
<b>HORIZONTAL FAN &amp; COIL SECTION - 6 ROW COIL</b>						
24 SHW	FVI-1	4-X	FVI-7	4-X	FVI-13	4-A
36 SHW	FVI-1	4-X	FVI-7	4-X	FVI-13	4-A
48 SHW	FVI-2	4-X	FVI-8	4-X	FVI-13	4-A
60 SHW	FVI-2	4-X	FVI-8	4-X	FVI-13	4-A
90 SHW	FVI-3	4-X	FVI-9	4-X	FVI-14	4-B
120 SHW	FVI-6	4-X	FVI-12	4-X	FVI-14	4-B
180 SHW	FVI-5	4-A	FVI-11	4-A	FVI-15	4-B
240 SHW	FVI-5	4-A	FVI-11	4-A	FVI-15	4-B
<b>HORIZONTAL FAN &amp; COIL SECTION - 4 ROW COIL WITH MIXING BOX</b>						
24 SHW	FVI-16	6-X	FVI-23	6-X	FVI-30	6-A
36 SHW	FVI-16	6-X	FVI-23	6-X	FVI-30	6-A
48 SHW	FVI-17	6-X	FVI-24	6-X	FVI-30	6-A
60 SHW	FVI-18	6-X	FVI-25	6-X	FVI-30	6-A
90 SHW	FVI-19	6-X	FVI-26	6-X	FVI-31	6-B
120 SHW	FVI-19	6-X	FVI-26	6-X	FVI-31	6-B
180 SHW	FVI-20	6-A	FVI-27	6-A	FVI-32	6-B
240 SHW	FVI-21	6-A	FVI-28	6-A	FVI-32	6-B
<b>HORIZONTAL FAN &amp; COIL SECTION - 6 ROW COIL WITH MIXING BOX</b>						
24 SHW	FVI-16	6-X	FVI-23	6-X	FVI-30	6-A
36 SHW	FVI-16	6-X	FVI-23	6-X	FVI-30	6-A
48 SHW	FVI-17	6-X	FVI-24	6-X	FVI-30	6-A
60 SHW	FVI-18	6-X	FVI-25	6-X	FVI-30	6-A
90 SHW	FVI-19	6-X	FVI-26	6-X	FVI-31	6-B
120 SHW	FVI-22	6-A	FVI-29	6-A	FVI-31	6-B
180 SHW	FVI-20	6-A	FVI-27	6-A	FVI-32	6-B
240 SHW	FVI-21	6-A	FVI-28	6-A	FVI-32	6-B

<b>NON-SEISMIC Base Selection for Floor Mounted Units</b>						
<b>SHW/SHX-VERTICAL SPRING ISOLATORS</b>						
						
UNIT MODEL NUMBER	MOUNTS		MOUNTS		MOUNTS	
	QTY & SIZE		QTY & SIZE		QTY & SIZE	
<b>HORIZONTAL FAN &amp; COIL SECTION - 4 ROW COIL</b>						
24 SVW	FVI-59	4-A	FVI-63	4-A	FVI-67	4-A
36 SVW	FVI-59	4-A	FVI-63	4-A	FVI-67	4-A
48 SVW	FVI-60	4-A	FVI-64	4-A	FVI-67	4-A
60 SVW	FVI-60	4-A	FVI-64	4-A	FVI-67	4-A
90 SVW	FVI-61	4-A	FVI-65	4-A	FVI-68	4-B
120 SVW	FVI-61	4-A	FVI-65	4-A	FVI-68	4-B
180 SVW	FVI-62	4-A	FVI-66	4-A	FVI-69	4-B
240 SVW	FVI-62	4-A	FVI-66	4-A	FVI-69	4-B
<b>HORIZONTAL FAN &amp; COIL SECTION - 6 ROW COIL</b>						
24 SVW	FVI-59	4-A	FVI-63	4-A	FVI-67	4-A
36 SVW	FVI-59	4-A	FVI-63	4-A	FVI-67	4-A
48 SVW	FVI-60	4-A	FVI-64	4-A	FVI-67	4-A
60 SVW	FVI-60	4-A	FVI-64	4-A	FVI-67	4-A
90 SVW	FVI-61	4-A	FVI-65	4-A	FVI-68	4-B
120 SVW	FVI-61	4-A	FVI-65	4-A	FVI-68	4-B
180 SVW	FVI-62	4-A	FVI-66	4-A	FVI-69	4-B
240 SVW	FVI-62	4-A	FVI-66	4-A	FVI-69	4-B
<b>HORIZONTAL FAN &amp; COIL SECTION - 4 ROW COIL WITH MIXING BOX</b>						
24 SVW	FVI-70	6-A	FVI-76	6-A	FVI-82	6-A
36 SVW	FVI-70	6-A	FVI-76	6-A	FVI-82	6-A
48 SVW	FVI-71	6-A	FVI-77	6-A	FVI-82	6-B
60 SVW	FVI-72	6-A	FVI-78	6-A	FVI-83	6-B
90 SVW	FVI-73	6-A	FVI-79	6-A	FVI-83	6-B
120 SVW	FVI-74	6-A	FVI-80	6-A	FVI-83	6-B
180 SVW	FVI-75	6-A	FVI-81	6-A	FVI-84	6-B
240 SVW	FVI-75	6-A	FVI-81	6-A	FVI-84	6-B
<b>HORIZONTAL FAN &amp; COIL SECTION - 6 ROW COIL WITH MIXING BOX</b>						
24 SVW	FVI-70	6-A	FVI-76	6-A	FVI-82	6-A
36 SVW	FVI-70	6-A	FVI-76	6-A	FVI-82	6-A
48 SVW	FVI-71	6-A	FVI-77	6-A	FVI-82	6-A
60 SVW	FVI-72	6-A	FVI-78	6-A	FVI-83	6-B
90 SVW	FVI-73	6-A	FVI-79	6-A	FVI-83	6-B
120 SVW	FVI-74	6-A	FVI-80	6-A	FVI-84	6-B
180 SVW	FVI-75	6-A	FVI-81	6-A	FVI-84	6-B
240 SVW	FVI-75	6-A	FVI-81	6-A	FVI-84	6-B

Volt	Phase	HP	FLA	MCA	Fuse	Qty	Part Number	
115	1	1/4	5.8	10	20	1	986FF11M3M	
		1/3	7.2	15	26	1	986FF11M4M	
		1/2	9.8	15	26	1		
		3/4	13.8	20	30	1	986FF11M5M	
		1	16.4	25	35	1	98FF11M6M	
		1-1/2	20.0	25	35	1		
		2	24.0	30	30	1	98FF11M7M	
277	1	1/4	2.4	6	6	1	986FF71M2M	
		1/3	3.0	6	6	1		
		1/2	4.1	6	6	1		
		3/4	5.7	10	10	1	986FF71M3M	
		1	6.8	10	10	1		
		1-1/2	8.5	15	15	1	986FF71M4M	
		2	10.0	15	15	1		
208/230	1	1/4	2.9	6	6	2	986FF31M2M	
		1/3	3.6	6	6	2	986FF31M3M	
		1/2	4.9	10	6	2		
		3/4	6.9	10	10	2		
		1	8.2	15	10	2	986FF31M4M	
		1-1/2	10.0	15	15	2		
		2	12.0	20	15	2	986FF31M5M	
208/230	3	1/4	N/A					
		1/3	1.6	3	3	3	986FF33M1M	
		1/2	2.4	6	6	3	986FF33M2M	
		3/4	3.5	6	6	3		
		1	5.6	10	10	3	986FF33M3M	
		1-1/2	6.6	10	10	3		
		2	7.5	15	15	3	986FF33M4M	
		3	10.6	15	15	3		
5	16.7	25	20	3	986FF33M6M			
460	3	1/4	N/A					
		1/3	0.8	3	3	3	986FF63M1M	
		1/2	1.1	3	3	3		
		3/4	1.6	3	3	3		
		1	3.7	6	6	3	986FF63M2M	
		1-1/2	3.0	6	6	3		
		2	3.7	6	6	3	986FF63M3M	
		3	4.8	10	10	3		
5	7.6	10	10	3				
575	3	1/4	N/A					
		1/3	N/A					
		1/2	0.9	3	3	3	986FF53M1M	
		3/4	1.3	3	3	3		
		1	1.7	3	3	3		
		1-1/2	2.4	3	3	3	986FF53M2M	
		2	2.7	6	6	3		
		3	3.9	6	6	3	986FF53M3M	
		5	6.1	10	10	3		

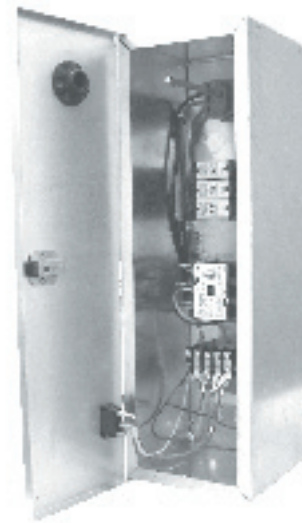

### FEATURES

DISCONNECT SWITCH  
HAND OFF AUTO (HOA) SWITCH  
POWER FUSING  
MOTOR CONTACTOR  
24V TRANSFORMER  
LOW VOLTAGE TERMINAL BLOCK  
FACTORY MOUNTED AND WIRED

## Ceiling Access Panels

PANEL NUMBER	FOR AE AIR FAN COIL MODEL	DESCRIPTION	FRAME DIMENSIONS (OPENING)		FRAME DIMENSIONS (OUTSIDE)		EST. SHIP. WT.
965 965-1	3-6(P)HBC, 3-8(P)HH, 36(P)HYX	LOUVERED NON-LOUVERED	24-1/2	40	27-1/2	43	18
966 966-1	8(P)HBC, 10(P)HH	LOUVERED NON-LOUVERED	24-1/2	46	27-1/2	49	20
967 967-1	10(P)HBC, 12(P)HH	LOUVERED NON-LOUVERED	24-1/2	52-1/2	27-1/2	55-1/2	22
967-4 967-5	13(P)HBC	LOUVERED NON-LOUVERED	24-1/2	67-1/8	27-1/2	70-1/8	30

### Features:

- \* Panels are surface mount . . . they don't have to perfectly match the opening
- \* Attractive baked on white epoxy coating (can be field painted)
- \* Filter clips are provided on louvered models to accept 20 x 20 filter (except 967-4, which has a 10 x 65 x 1 factory installed filter)
- \* Hinged panel can be reversed for better clearance
- \* All panels have "captive" door screws



**LOUVERED (default style)**  
(965, 966, 967, 967-4)



**NON-LOUVERED**  
(965-1, 966-1, 967-1)



## Thermostats and Accessories

PART NO.	VOLT.	DESCRIPTION	MANUFACT.	MANUFACT. NUMBER	FOR USE WITH
T420	120/240/277	MANUAL CHANGEOVER W/3-SPEED SWITCH	SUNNE	---	HBC SERIES, CW, CW-HW, CWE
T421	120/240/277	AUTO CHANGEOVER W/3-SPEED SWITCH	SUNNE	---	HBC SERIES, CW, CW-HW, CWE
E332	120/240/277	3 SPEED WALL SWITCH WITH OFF POSITION	---	---	HBC SERIES
E332-1	120/240/277	3 SPEED WALL SWITCH WITH ON OFF POSITION	---	---	HBC SERIES
310-E301	120/24	RELAY/TRANSFORMER	---	---	MOST 120V FAN COILS
310-E302	220/24	RELAY/TRANSFORMER	---	---	MOST 240V FAN COILS
310-E303	277/24	RELAY/TRANSFORMER	---	---	MOST 277V FAN COILS
T4071	120/240/277	AQUASTAT	---	---	MOST 120V FAN COILS
919-1	---	EXDENDED DRIP LIP	---	---	HBC,HH,PHBC,CHBC,RHBC SERIES
T630	24	DIGITAL WALL STAT (STRAIGHT COOL ONLY)	---	---	MOST 24V CONTROL PRODUCTS
T832	24	PROGRAMABLE TOUCHSCREEN	---	---	MOST 24V CONTROL PRODUCTS
T200	24	24V, 3-SPEED WALL STAT (MANUAL)	---	---	HBC SERIES, HYB/PHYB, CW, CW-HW, CWE
T201	24	24V, 3-SPEED WALL STAT (AUTO)	---	---	HBC SERIES, HYB/PHYB, CW, CW-HW, CWE
943-1D	120	CONTROLLER FOR T200 & T201 (WITH DISCONNECT)	---	---	HBC SERIES
SS3	24	CONDENSATE FLOAT SWITCH	---	---	VARIOUS

### VALVE CLUSTERS AND INDIVIDUAL COMPONENTS:

For (R,P,C) HBC, HH, PHH, MB, MB-HW, MBE

**Assembled Valve Clusters:** (factory-assembled and field installed) Components are factory piped together (**order power heads separately**). Contact factory for other options.

	Right Hand	Left Hand	Description (all 1/2")
2 pipe	9VHR2BV	9VHL2BV	2-pipe, 2 hand valves only
	9VHR22B	9VHL22B	2-pipe, one <b>2-way</b> valve body and 2 hand valves
	9VHR23B	9VHL23B	2-pipe, one <b>3-way</b> valve body and 2 hand valves
4 pipe	9VHR4BV	9VHL4BV	4-pipe, 4 hand valves only
	9VHR42B	9VHL42B	4-pipe, one <b>2-way</b> valve bodies and 4 hand valves
	9VHR43B	9VHL43B	4-pipe, one <b>3-way</b> valve bodies and 4 hand valves

#### Power Heads: (two power heads required for 4-pipe)

E50131180	24V
E50132180	110V/50Hz - 120V/60Hz
E50137180	277V
E50138180	220V/50Hz - 230V/60Hz

#### Separate Valve Bodies: (order power heads separately)

E421213	1/2" 2-way
E431213	1/2" 3-way
E421317	3/4" 2-way
E431317	3/4" 3-way
E421417	1" 2-way
E431417	1" 3-way

#### Hand Valves: (Combination balance / shut-off) (2 usually req'd per coil)

CP9	1/2"
CP90	3/4"
CP905	1"

#### Circuit Setters and Strainers

CP601	1/2" Circuit Setter (Taco)
CP12	1/2" Circuit Setter (Bell and Gossett)
CP603	1/2" Strainer (Kitz)
CP6011	3/4" Circuit Setter (Taco)
CP6031	3/4" Strainer (Kitz)

**NOTES:**



**7 Day or 12 Day Production Available**

**Direct Expansion or Chilled Water**

**Quick Ship Price Adder**

**Horizontal Belt Drive**

MODEL	7 Day	12 Day
24-60SHW(X)-4 or 6 Row	20%	10%
90-120SHW(X)-4 or 6 Row		
180-240-SHW(X)-4 or 6 Row		
8-80WHW(X)-4 or 6 Row		

**Vertical Belt Drive**

Model	7 Day	12 Day
24-60SVW(X)-4 or 6 Row	20%	10%
24-60SVW(X)-4 or 6 Row		
180-240-SVW(X)-4 or 6 Row		

Quantities are limited on the Quick Ship option, contact the factory to verify lead time based on quantities prior to ordering.

**7 or 12** working day production orders begin the day after orders are received if all required information is included. (See Note)

**Note:** The following information is required for **Quick Ship** belt drive orders - Actual voltage and phase, CFM and ESP, \*RH or LH connections.

\*Horizontal or Vertical Hand connections are determined by looking toward the filter (or supply air hitting you in back of head)

**Belt Drive Accessories**

Accessory	Size	7 Day	12 Day
Hot Water Coil Preheat or Reheat	24-60	20%	10%
	90-120		
	180-240		
***986FF Motor Control Box	All	20%	10%
Discharge Plenum	24-60	20%	10%
	90-120		
	180-240		
Mixing Box	24-60	20%	10%
	90-120		
	180-240		
Stainless Steel Drain Pan Plus add for SS option	24-60	30%	20%
	90-120		
	180-240		
Foil Insulation Plus add for Foil option Contact Factory for Foil Availability	24-60	30%	20%
	90-120		
	180-240		
Discharge Electric Heater	ALL	20%	10%
***986FR Ram Motor Starter Box not available on Quick Ship Allow 4 to 6 weeks to ship			

\*\*Available voltages include: 120/1/60, 208/1/60, 240/1/60, \*\*277/1/60, 208/3/60, 240/3/60, 480/3/60, \*\*575/3/60

\*\* Some motor voltages may require additional lead time

