

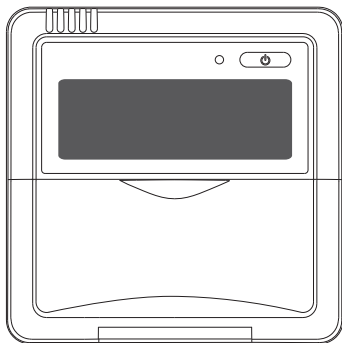

WIRED REMOTE CONTROLLER

OWNER'S MANUAL



All the pictures in this manual are for explanation purpose only. There may be slightly different from the wired remote controller you purchased (depend on model). The actual shape shall prevail.

Table of Contents

1. Remote Control Buttons	01
2. LCD Screen	04
3. Basic Functions	05
4. Troubleshoot your remote control	15

Remote Control Buttons

MODE BUTTON

- Used to select the operating mode
— AUTO — COOL — DRY — HEAT — FAN —
- For cooling-only units, there is no HEAT function.

TIMER ON BUTTON

- Used to automatically turn on the air conditioner at a specified time.

TIMER OFF BUTTON

- Used to automatically turn off the air conditioner at a specified time.

FOLLOW ME BUTTON

- Allows the remote control to act as a remote thermostat and relay temperature information from its current location.

AUXILIARY ELECTRICAL HEATER

- The Auxiliary Electric Heater warms up the unit in cold climates.
- If pressed during HEAT mode, the electric heater function becomes ineffective.

ON/OFF BUTTON

- Used to start/stop the air conditioner.

ADJUST BUTTON

- The UP (▲) and DOWN (▼) buttons are used to adjust the temperature.
- Press these two buttons at the same time to switch between Celsius and Fahrenheit (some models)

SWING BUTTON

- The SWING button starts and stops the louver movement and sets the desired airflow direction.

ECONOMY BUTTON

- Used to activate/deactivate ECONOMY Mode, in which the unit maintains a comfortable temperature during sleeping hours.

FAN SPEED BUTTON

- Used to select the fan speed.



RESET BUTTON

- Used to restore the system to its default settings.

LOCK BUTTON

- Used to lock/unlock the current setting.

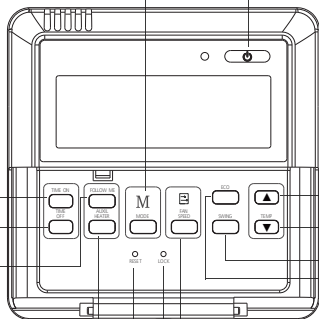

Fig. 1

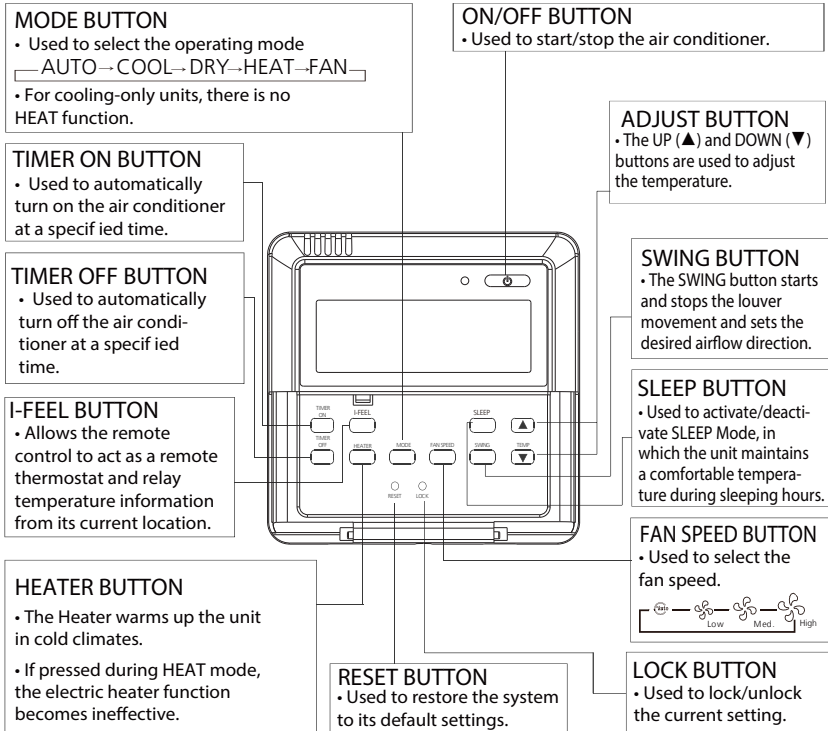

Fig. 2



WARNING

- **DO NOT** remove the cover or touch the interior parts of the remote control.
- **DO NOT** use sharp or pointed objects to press the remote control buttons.

LCD Screen

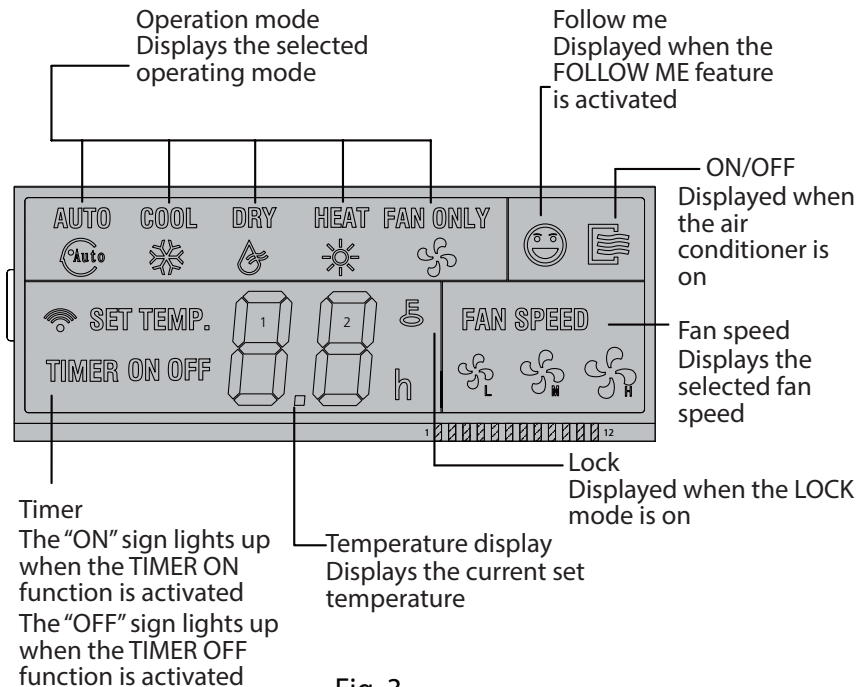

Fig. 3

Basic Functions

The following are instructions for using your air conditioner's basic functions.

AUTO Function

In AUTO mode, the unit will automatically select the COOL, HEAT, FAN or DRY function based on the set temperature.

1 Press the MODE button, select AUTO.

2 Set your desired temperature using the UP (▲) and DOWN (▼) buttons.

3 Press the ON/OFF button to start the unit.

NOTE: In AUTO mode, the fan speed is automatically set on AUTO mode and cannot be changed.

ECONOMY Mode can also be activated.

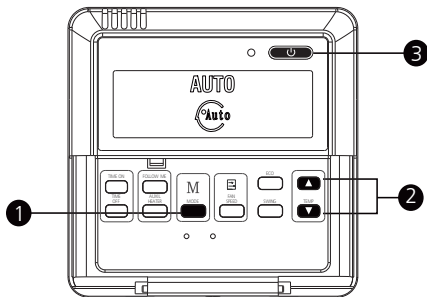

Fig. 4

COOL/HEAT/FAN Function

- 1 Press the MODE button to select COOL, HEAT or FAN.
- 2 Set your desired temperature using the UP (▲) and DOWN (▼) buttons.
- 3 Press the FAN SPEED button to select the fan speed.
- 4 Press the ON/OFF button to start the unit.

NOTE: In FAN mode, the temperature cannot be changed.

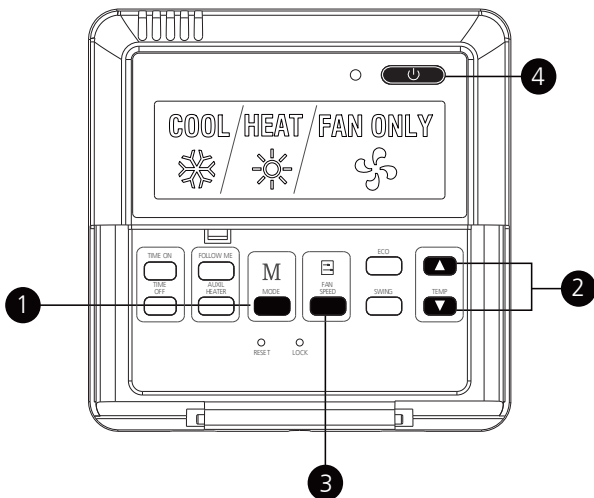

Fig. 5

DRY Function

- 1 Press the MODE button, select DRY.
- 2 Set your desired temperature using the UP (▲) and DOWN (▼) buttons.
- 3 Press the ON/OFF button to start the unit.

NOTE: In DRY mode, the ECONOMY and FAN SPEED buttons cannot be used.

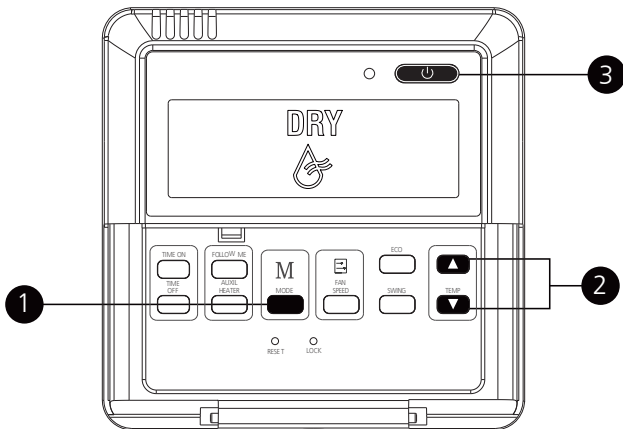

Fig. 6

FOLLOW ME Function

The FOLLOW ME function enables the remote control to measure the temperature at its current location. When using AUTO, COOL, or HEAT functions, measuring ambient temperature from the remote control (instead of from the indoor unit itself) will enable the air conditioner to make sure that the temperature around you is optimized for your comfort.

- 1 Press FOLLOW ME button to activate function. The remote control will send temperature signal to the indoor unit every three minutes.
- 2 Press FOLLOW ME button again to turn off this function.

NOTE: The swing function can only be used in SWING mode.

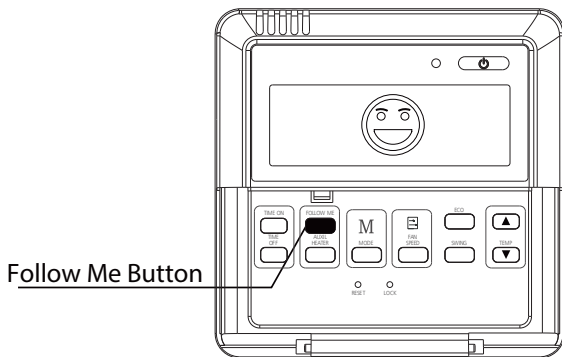

Fig. 7

Setting Air Flow Direction

- 1 Press the SWING button to activate the swing function. Press this button again to set the louver in the position you want.
- 2 Press and hold the SWING button for three seconds to make the louver move continuously.

NOTE: The swing function can only be used in SWING mode. The swing range of the louvers is 30°.

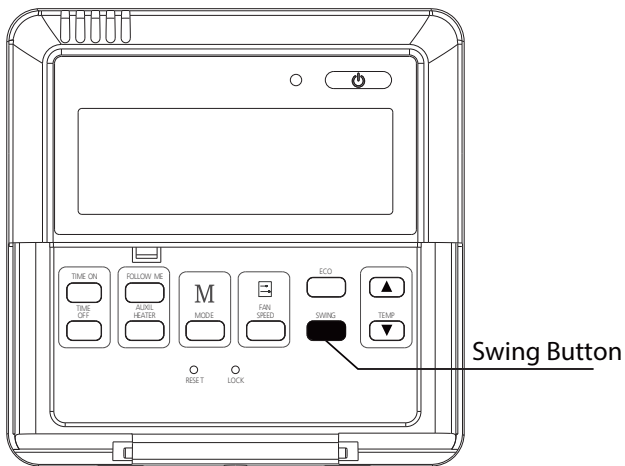

Fig. 8

TIMER Function

Your air conditioning unit has two timer-related functions:

- **TIMER ON** – sets the amount of time after which the unit will automatically turn on. (Delayed on)
- **TIMER OFF** – sets the amount of time after which the unit will automatically turn on. (Delayed off)

1. TIMER ON Function

The **TIMER ON** function allows you to set a period of time after which the unit will automatically turn on, such as when you come home from work.

- a Press **TIMER ON** button. By default, the last time period that you set and an “H” (indicating hours) will appear on the display.

NOTE : This number indicates the amount of time after the current time that you want the unit to turn on. For example, if you set **TIMER ON** for 2 hours, “2.0 H” will appear on the screen, and the unit will turn on after 2 hours.

- b Press **TIMER ON** button repeatedly to set the time you want the unit to turn on.
- c Wait 3 seconds, then the **TIMER ON** function will be activated. The digital display on your remote control will then return to the temperature display.

Example: Setting unit to turn on after 2.5 hours.

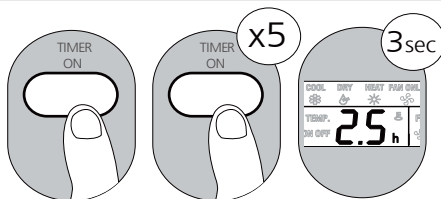

Fig. 9

2. TIMER OFF Function

The TIMER OFF function allows you to set a period of time after which the unit will automatically turn off, such as when you wake up.

Example: Setting unit to turn on after 5 hours.

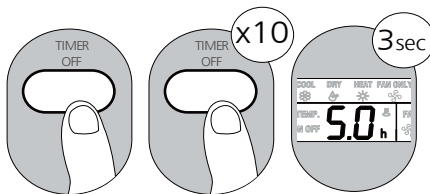

Fig. 10

NOTE: When setting the TIMER ON or TIMER OFF functions, up to 10 hours, the time will increase in 30 minute increments with each press. After 10 hours and up to 24, it will increase in 1 hour increments. The timer will revert to zero after 24 hours. You can turn off either function by setting its timer to "0.0 H."

Setting both TIMER ON and TIMER OFF at the same time (Combined Timer Function)

Keep in mind that the time periods you set for both functions refer to hours after the current time. For example, say that the current time is 1:00 PM, and you want the unit to turn on automatically at 7:00 PM. You want it to operate for 2 hours, then automatically turn off at 9:00 PM.

Do the following:

1. Press TIMER ON button. The last TIMER ON setting will appear.
2. Press TIMER ON button repeatedly until "6.0 H" is displayed on remote control. (6 hours after 1:00 PM, which is 7:00 PM.)
3. Wait 3 seconds, and the TIMER ON function will be activated.
4. Then press TIMER OFF button. The last TIMER OFF setting will appear.
5. Press TIMER OFF button repeatedly until "8.0 H" is displayed on remote control. (8 hours after 1:00 PM, which is 9:00 PM.)
6. Wait 3 seconds, and the TIMER OFF function will be activated.

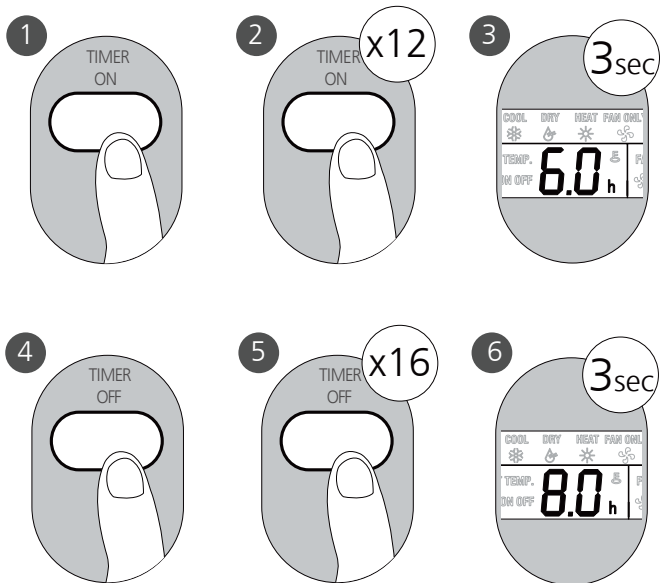

Fig. 11

The unit will now turn on after 6 hours (7:00 PM) and turn off again after 8 hours (9:00 PM). (See Fig. 11)

Your remote display

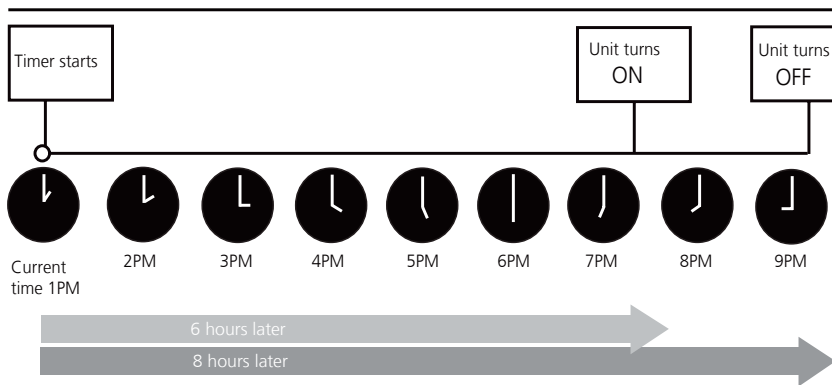
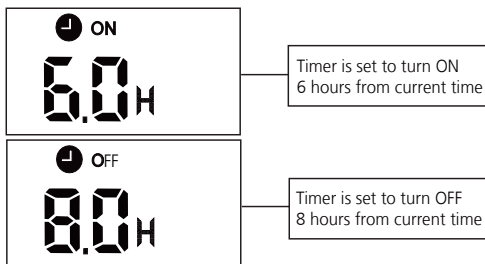

Fig. 12

Troubleshoot Your Remote Control

Symptoms	Possible Causes	Solution
The fan speed cannot be changed.	Check whether AUTO mode is selected.	In AUTO mode, the fan speed is set automatically and cannot be changed.
	Check whether DRY mode is selected.	In DRY mode, the FAN SPEED button is ineffective. The fan speed can only be changed in COOL, FAN and HEAT mode.
The temperature display is off	Check whether FAN mode is selected.	In FAN mode, the temperature cannot be adjusted.
The TIMER OFF disappears after a period of time	If the TIMER OFF function was activated, the operation may have finished.	The air conditioner will automatically stop at the set time and the indicator light will turn off.
The TIMER ON indicator disappears after a period of time	If the TIMER ON function was activated, the operation may have finished.	The air conditioner will automatically start at the set time and the indicator light will turn off.
There is no sound when the ON/OFF button is pressed.	Check whether the signal transmitter of the remote control is properly directed towards the infrared signal receiver of the indoor unit.	Point the remote control directly at the receiver and press the ON/OFF button twice.

The design and specifications are subject to change without prior notice for product improvement. Consult with the sales agency or manufacturer for details.



turn to the experts 