

Installation and Operation Manual DC Inverter Cassette Type Unit

Air Conditioners

Indoor Unit

Outdoor Unit



MQS-174018-CCK216A	MQIU-174018-HCU216A
MQS-174024-CCK216A	MQIU-174024-HCU216A
MQS-174036-CCK216A	MQIU-174036-HCU216A
MQS-174048-CCK216A	MQIU-174048-HCU216A
MQS-174060-CCK216A	MQIU-174060-HCU216A

- Thank you for choosing these Air Conditioners, please read this owner's manual carefully before operation and retain it for future reference.

Contents

1 Safety Precautions	1
2 Outline of the Unit and Main Parts	3
3 User's manual of remote controller.....	4
3.1 Buttons on remote controller	4
3.2 Introduction for icons on display screen.....	4
3.3 Introduction for buttons on remote controller.....	5
3.4 Function introduction for combination buttons	8
3.5 Operation guide	9
3.6 Replacement of batteries in remote controller	9
4 Preparative for Installation	10
4.1 Standard Accessory Parts.....	10
4.2 Selection of the Installation Location	11
4.3 Connection Pipe Requirement.....	13
4.4 Electrical Requirement.....	14
5 Installation of the Unit	15
5.1 Installation of the Indoor Unit	15
5.2 Installation of the Outdoor Unit.....	18
5.3 Installation of the Connection Pipe	19
5.4 Vacuum and Gas Leakage Inspection.....	23
5.5 Installation of the Drain Hose.....	25
5.6 The Panel Installation	29
5.7 Electrical Wiring	31
6 Installation of Controllers	36
7 Test Running	37
7.1 Trial Operation and Testing.....	37
7.2 Working Temperature Range	39
8 Troubleshooting and Maintenance.....	39
8.1 Troubleshooting	39
8.2 Routine Maintenance	40

1 Safety Precautions

 WARNING!	This mark indicates procedures which, if improperly performed, might lead to the death or serious injury of the user.
 CAUTION!	This mark indicates procedures which, if improperly performed, might possibly result in personal harm to the user, or damage to property.

 WARNING!	
(1).	Installation should be left to the dealer or another professional. Improper installation may cause water leakage, electrical shock, or fire.
(2).	Install the air conditioner according to the instructions given in this manual. Incomplete installation may cause water leakage, electrical shock, or fire.
(3).	Be sure to use the supplied or specified installation parts. Use of other parts may cause the unit to come to lose, water leakage, electrical shock, or fire.
(4).	Install the air conditioner on a solid base that can support the weight of the unit. An inadequate base or incomplete installation may cause injury in the event the unit falls off the base.
(5).	Electrical work should be carried out in accordance with the installation manual and the national electrical wiring rules or code of practice. Insufficient capacity or incomplete electrical work may cause electrical shock or fire.
(6).	Be sure to use a dedicated power circuit. Never use a power supply shared by another appliance.
(7).	For wiring, use a cable length enough to cover the entire distance with no connection. Do not use an extension cord. Do not put other loads on the power supply, use a dedicated power circuit. (Failure to do so may cause abnormal heat, electric shock or fire.)
(8).	Use the specified types of wires for electrical connections between the indoor and outdoor units. Firmly clamp the interconnecting wires so their terminals receive no external stresses. Incomplete connections or clamping may cause terminal overheating or fire.
(9).	After connecting interconnecting and supply wiring be sure to shape the cables so that they do not put undue force on the electrical covers or panels. Install covers over the wires. Incomplete cover installation may cause terminal overheating, electrical shock, or fire.
(10).	If any refrigerant has leaked out during the installation work, ventilate the room. (The refrigerant produces a toxic gas if exposed to flames.)
(11).	After all installation is complete, check to make sure that no refrigerant is leaking out. (The refrigerant produces a toxic gas if exposed to flames.)
(12).	When installing or relocating the system, be sure to keep the refrigerant circuit free from substances other than the specified refrigerant (R410A), such as air. (Any presence of air or other foreign substance in the refrigerant circuit causes an abnormal pressure rise or rupture, resulting in injury.)
(13).	During pump-down, stop the compressor before removing the refrigerant piping. If the compressor is still running and the stop valve is open during pump-down, air will be sucked in when the refrigerant piping is removed, causing abnormal pressure in the freezer cycle which will lead to breakage and even injury.
(14).	During installation, attach the refrigerant piping securely before running the compressor. If the compressor is not attached and the stop valve is open during pump-down, air will be sucked in when the compressor is run, causing abnormal pressure in the freezer cycle which will lead to breakage and even injury.

DC Inverter U-match Series Cassette Type Unit

- | |
|---|
| (15). Be sure to establish an earth. Do not earth the unit to a utility pipe, arrester, or telephone earth. Incomplete earth may cause electrical shock, or fire. A high surge current from lightning or other sources may cause damage to the air conditioner. |
| (16). Be sure to install an earth leakage breaker. Failure to install an earth leakage breaker may result in electric shocks, or fire. |
| (17). This appliance is not intended for use by persons (including children) with reduced physical, sensory or mental capabilities, or lack of experience and knowledge, unless they have been given supervision or instruction concerning use of the appliance by a person responsible for their safety. |
| (18). Children should be supervised to ensure that they do not play with the appliance. |
| (19). If the supply cord is damaged, it must be replaced by the manufacturer, its service agent or similarly qualified persons in order to avoid a hazard. |



CAUTION!

- | |
|---|
| (1). Do not install the air conditioner in a place where there is danger of exposure to inflammable gas leakage. If the gas leaks and builds up around the unit, it may catch fire. |
| (2). Establish drain piping according to the instructions of this manual. Inadequate piping may cause flooding. |
| (3). Tighten the flare nut according to the specified method such as with a torque wrench. If the flare nut is tightened too hard, the flare nut may crack after a long time and cause refrigerant leakage. |

Climaproyectos
.com

2 Outline of the Unit and Main Parts

Indoor

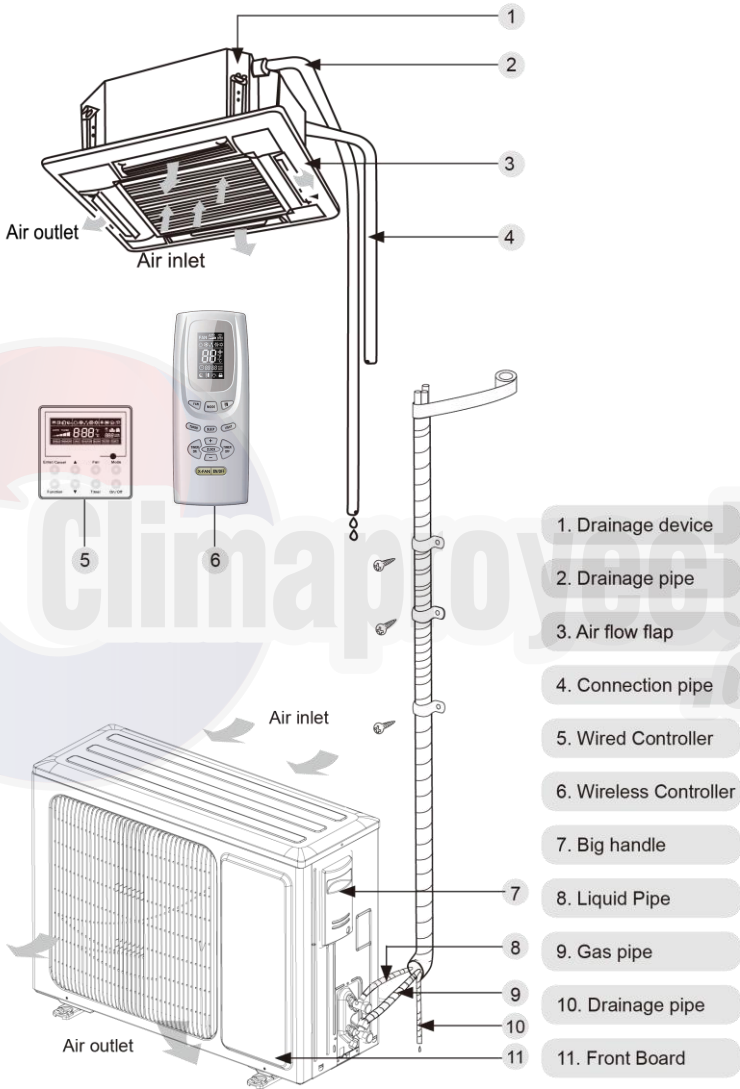
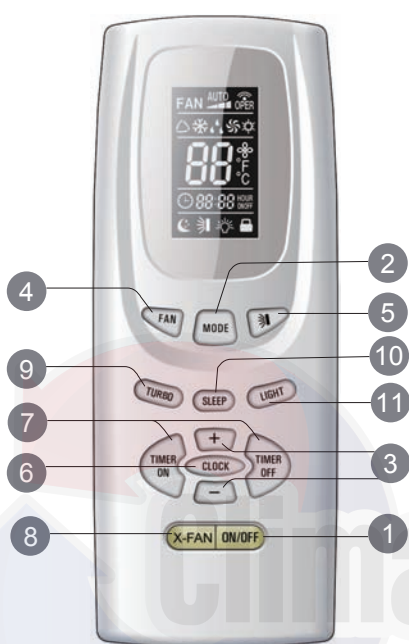

Fig. 2.1

3 User's manual of remote controller

3.1 Buttons on remote controller



- 1 ON/OFF button
- 2 MODE button
- 3 +/- button
- 4 FAN button
- 5 button
- 6 CLOCK button
- 7 TIMER ON/TIMER OFF button
- 8 X-FAN button
Note: X-FAN is the same with BLOW
- 9 TURBO button
- 10 SLEEP button
- 11 LIGHT button

3.2 Introduction for icons on display screen

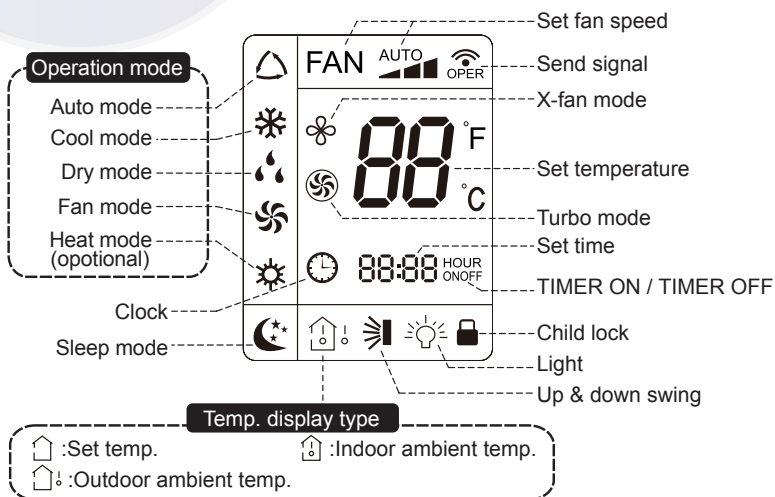

3.3 Introduction for buttons on remote controller

Note:

- After putting through the power, the air conditioner will give out a sound. Operation indicator "⏻" is ON (red indicator). After that, you can operate the air conditioner by using remote controller.

1 ON/OFF button

Press this button can turn on or turn off the air conditioner. After turning on the air conditioner, operation indicator "⏻" on indoor unit's display is ON (green indicator). The colour is different for different models), and indoor unit will give out a sound.

2 MODE button

Press this button to select your required operation mode.



- When selecting auto mode, air conditioner will operate automatically according to ex-factory setting. Set temperature can't be adjusted and will not be displayed as well. Press "FAN" button can adjust fan speed. Press "↗" button can adjust fan blowing angle.
- After selecting cool mode, air conditioner will operate under cool mode. Cool indicator "❄" on indoor unit is ON. Press "+" or "-" button to adjust set temperature. Press "FAN" button to adjust fan speed. Press "↗" button to adjust fan blowing angle.
- When selecting dry mode, the air conditioner operates at low speed under dry mode. Dry indicator "💧" on indoor unit is ON. Under dry mode, fan speed can't be adjusted. Press "↗" button to adjust fan blowing angle.
- When selecting fan mode, the air conditioner will only blow fan, no cooling and no heating. All indicators are OFF. Press "FAN" button to adjust fan speed. Press "↗" button to adjust fan blowing angle.
- When selecting heating mode, the air conditioner operates under heat mode. Heat indicator "☀" on indoor unit is ON. Press "+" or "-" button to adjust set temperature. Press "FAN" button to adjust fan speed. Press "↗" button to adjust fan blowing angle. (Cooling only unit won't receive heating mode signal. If setting heat mode with remote controller, press ON/OFF button can't start up the unit).

Note:

- For preventing cold air, after starting up heating mode, indoor unit will delay 1~5 minutes to blow air (actual delay time is depend on indoor ambient temperature).
- Set temperature range from remote controller: 16~30°C ; Fan speed: auto, low speed, medium speed, high speed.

3.3 Introduction for buttons on remote controller

3 +/- button

- Press "+" or "-" button once increase or decrease set temperature 1°C . Holding "+" or "-" button, 2s later, set temperature on remote controller will change quickly. On releasing button after setting is finished, temperature indicator on indoor unit will change accordingly. (Temperature can't be adjusted under auto mode)
- When setting TIMER ON, TIMER OFF or CLOCK, press "+" or "-" button to adjust time. (Refer to CLOCK, TIMER ON, TIMER OFF buttons) When setting TIMER ON, TIMER OFF or CLOCK, press "+" or "-" button to adjust time. (Refer to CLOCK, TIMER ON, TIMER OFF buttons)

4 FAN button

Pressing this button can set fan speed circularly as: auto (AUTO), low(▲), medium (▲▲), high(▲▲▲).

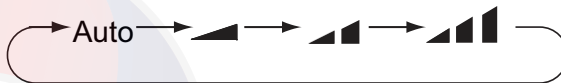

Note:

- Under AUTO speed, air conditioner will select proper fan speed automatically according to ex-factory setting.
- Fan speed under dry mode is low speed.

5 扇叶按钮

Press this button can select up&down swing angle. Fan blow angle can be selected circularly as below:

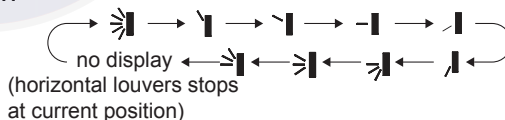

- When selecting "扇叶", air conditioner is blowing fan automatically. Horizontal louver will automatically swing up & down at maximum angle.
- When selecting "扇叶", "扇叶", "扇叶", "扇叶", "扇叶", air conditioner is blowing fan at fixed position. Horizontal louver will stop at the fixed position.
- When selecting "扇叶", "扇叶", "扇叶", air conditioner is blowing fan at fixed angle. Horizontal louver will send air at the fixed angle.
- Hold "扇叶" button above 2s to set your required swing angle. When reaching your required angle, release the button.

Note:

- "扇叶", "扇叶", "扇叶" may not be available. When air conditioner receives this signal, the air conditioner will blow fan automatically.

3.3 Introduction for buttons on remote controller

6 CLOCK button

Press this button to set clock time. "🕒" icon on remote controller will blink. Press "+" or "-" button within 5s to set clock time. Each pressing of "+" or "-" button, clock time will increase or decrease 1 minute. If hold "+" or "-" button, 2s later, time will change quickly. Release this button when reaching your required time. Press "CLOCK" button to confirm the time. "🕒" icon stops blinking.

Note:

- Clock time adopts 24-hour mode.
- The interval between two operation can't exceeds 5s. Otherwise, remote controller will quit setting status. Operation for TIMER ON/TIMER OFF is the same.

7 TIMER ON / TIMER OFF button

• TIMER ON button

"TIMER ON" button can set the time for timer on. After pressing this button, "🕒" icon disappears and the word "ON" on remote controller blinks. Press "+" or "-" button to adjust TIMER ON setting. After each pressing "+" or "-" button, TIMER ON setting will increase or decrease 1min. Hold "+" or "-" button, 2s later, the time will change quickly until reaching your required time. Press "TIMER ON" to confirm it. The word "ON" will stop blinking. "🕒" icon resumes displaying. Cancel TIMER ON: Under the condition that TIMER ON is started up, press "TIMER ON" button to cancel it.

• TIMER OFF button

"TIMER OFF" button can set the time for timer off. After pressing this button, "🕒" icon disappears and the word "OFF" on remote controller blinks. Press "+" or "-" button to adjust TIMER OFF setting. After each pressing "+" or "-" button, TIMER OFF setting will increase or decrease 1min. Hold "+" or "-" button, 2s later, the time will change quickly until reaching your required time. Press "TIMER OFF" word "OFF" will stop blinking. "🕒" icon resumes displaying. Cancel TIMER OFF. Under the condition that TIMER OFF is started up, press "TIMER OFF" button to cancel it.

Note:

- Under on and off status, you can set TIMER OFF or TIMER ON simultaneously.
- Before setting TIMER ON or TIMER OFF, please adjust the clock time.
- After starting up TIMER ON or TIMER OFF, set the constant circulating valid. After that, air conditioner will be turned on or turned off according to setting time. ON/OFF button has no effect on setting. If you don't need this function, please use remote controller to cancel it.

3.3 Introduction for buttons on remote controller

8 X-FAN button

Press this button under cool and dry mode to start up x-fan function, and "🌀" icon on remote controller will be displayed. Press this button again to cancel x-fan function, and "🌀" icon will disappear.

Note:

- When x-fan function is on, if the air conditioner is turned off, indoor fan will still operate at low speed for a while to blow the residual water inside the air duct.
- During x-fan operation, press X-FAN button to turn off x-fan function. Indoor fan will stop operation immediately.

9 TURBO button

Under COOL or HEAT mode, press this button to turn to quick COOL or quick HEAT mode. "🌀" icon is displayed on remote controller. Press this button again to exit turbo function and "🌀" icon will disappear.

10 SLEEP button

Under COOL, HEAT or DRY mode, press this button to start up sleep function. "🌙" icon is displayed on remote controller. Press this button again to cancel sleep function and "🌙" icon will disappear.

11 LIGHT button

Press this button to turn off display light on indoor unit. "💡" icon on remote controller disappears. Press this button again to turn on display light. "💡" icon is displayed.

3.4 Function introduction for combination buttons

Child lock function

Press "+" and "-" simultaneously to turn on or turn off child lock function. When child lock function is on, "🔒" icon is displayed on remote controller. If you operate the remote controller, the "🔒" icon will blink three times without sending signal to the unit.

Temperature display switchover function

Under OFF status, press "-" and "MODE" buttons simultaneously to switch temperature display between °C and °F .

3.5 Operation guide

1. After putting through the power, press "ON/OFF" button on remote controller to turn on the air conditioner.
2. Press "MODE" button to select your required mode: AUTO, COOL, DRY, FAN, HEAT.
3. Press "+" or "-" button to set your required temperature. (Temperature can't be adjusted under auto mode).
4. Press "FAN" button to set your required fan speed: auto, low, medium and high speed.
5. Press "↻" button to select fan blowing angle.

3.6 Replacement of batteries in remote controller

1. Press the back side of remote controller marked with "🔍", as shown in the fig, and then push out the cover of battery box along the arrow direction.
2. Replace two 7# (AAA 1.5V) dry batteries, and make sure the position of "+" polar and "-" polar are correct.
3. Reinstall the cover of battery box.

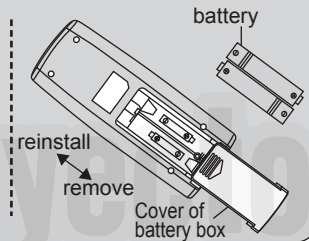

Note:

- During operation, point the remote control signal sender at the receiving window on indoor unit.
- The distance between signal sender and receiving window should be no more than 8m, and there should be no obstacles between them.
- Signal may be interfered easily in the room where there is fluorescent lamp or wireless telephone; remote controller should be close to indoor unit during operation.
- Replace new batteries of the same model when replacement is required.
- When you don't use remote controller for a long time, please take out the batteries.
- If the display on remote controller is fuzzy or there's no display, please replace batteries.

4 Preparative for Installation

4.1 Standard Accessory Parts

The standard accessory parts listed below are furnished and should be used as required.

Table 3.1

















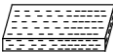

Indoor Unit Accessories				
No.	Name	Appearance	Q'ty	Usage
1	Drain Hose		1	To connect with the hard PVC drain pipe
2	Nut with Washer		4	To fix the hook on the cabinet of the unit.
3	Washer		10	To be used together with the hanger bolt for installing the unit.
4	installation paperboard		1	used for ceiling drilling
5	Gasket mounting board		4	Used to prevent gasket from falling off
6	Wireless Controller +Battery		1+2	To control the indoor unit
7	sealing plaster		1	
8	Fastener		4	To fasten the sponge
9	Insulation		1	To insulate the gas pipe
10	Insulation		1	To insulate the liquid pipe
11	Sponge		4	To insulate the drain pipe
12	Nut		1	To connect gas pipe
13	Nut		1	To connect liquid pipe
14	Enswathement		2	

Table 3.2

Outdoor Unit Accessories				
No.	Name	Appearance	Q'ty	Usage
1	Drain Plug		2or3	To plug the unused drain hole.
2	Drainage Connector	 or 	1	To connect with the hard PVC drain pipe

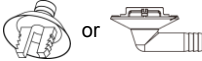
4.2 Selection of the Installation Location

 WARNING!
The unit must be installed where strong enough to withstand the weight of the unit and fixed securely, otherwise the unit would topple or fall off.
 CAUTION!
①. Do not install where there is the danger of combustible gas leakage.
②. Do not install the unit near heat source of heat, steam, or flammable gas.
③. Children under 10 years old must be supervised not to operate the unit.

Decide the installation location with the customer as follows:

4.2.1 Indoor Unit

Select an installation site where the following conditions are fulfilled and that meets your customer's approval.

- (1). Obstruct should be put away from the intake or outlet vent of the indoor unit so that the airflow can be blown through all the room.
- (2). Make sure that the installation meets the requirement of the schematic diagram of installation spaces.
- (3). Select the place where can stand 4 times of the weight of the indoor unit and would not increase the operating noise and vibration.
- (4). The horizontality of the installation place should be guaranteed.
- (5). Select the place where is easy to drain out the condensate water, and connect with outdoor unit.
- (6). Make sure that there are enough space for care and maintenance, and the height fall between the indoor unit and ground is above 1800mm.
- (7). When installing the suspension bolt, check if the installation place can stand 4 times of the weight of the unit. If not, reinforce it before installation.

Note: There will be large amount of greasy dirt accumulated on the fan, heat exchanger and water pump located in the dining room and kitchen, which would reduce the capacity of the heater exchanger, lead to leakage and abnormal operation of the water pump.

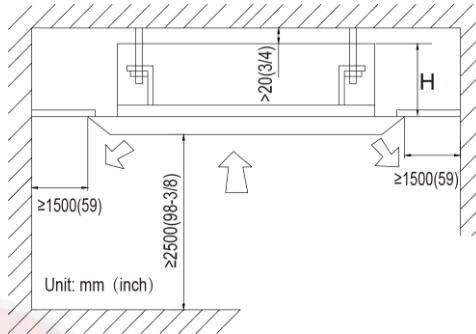

Fig. 3.1
Table 3.3

Models	H(mm)
MQS-174018-CCK216A	255
MQS-174024-CCK216A	260
MQS-174036-CCK216A	340
MQS-174048-CCK216A	320
MQS-174060-CCK216A	320

4.2.2 Outdoor Unit

⚠ WARNING!

- ①. Install the unit where it will not be tilted by more than 5°.
- ②. During installation, if the outdoor unit has to be exposed to strong wind, it must be fixed securely.

If possible, do not install the unit where it will be exposed to direct sunlight. (If necessary, install a blind that does not interfere with the air flow.)

- (1). Install the outdoor unit in a place where it will be free from being dirty or getting wet by rain as much as possible.
- (2). Install the outdoor unit where it is convenient to connect with the indoor unit.
- (3). Install the outdoor unit where the condensate water can be drained out freely during heating operation.
- (4). Do not place animals and plants in the path of the warm air.
- (5). Take the air conditioner weight into account and select a place where noise

and vibration are small.

- (6). Install the outdoor unit where is capable of withstanding the weight of the unit and generates as less noise and vibration as possible.
- (7). Provide the space shown in Fig. 3.2, so that the air flow is not blocked. Also for efficient operation, leave three of four directions of peripheral constructions open.

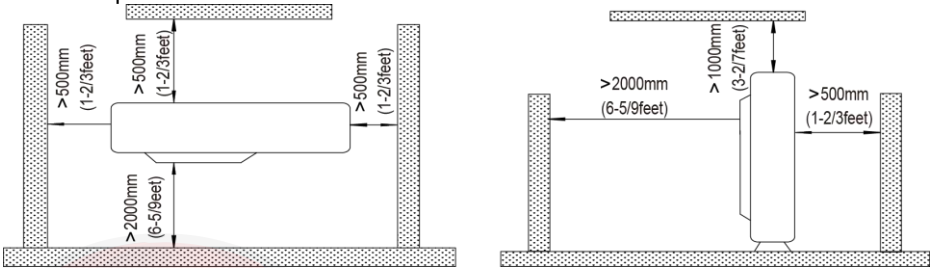

Fig. 3.2

4.3 Connection Pipe Requirement



The maximum length of the connection pipe is listed in the Table below. Do not place the units between which the distance exceeds the maximum length of the connection pipe.

Table 3.4

Item Model	Size of Fitting Pipe(Inch)		Max. Pipe Length (m)	Max. Height Difference between Indoor Unit and Outdoor Unit (m)	Drainage pipe(Outer Diameter × wall thickness) (mm)
	Liquid	Gas			
MQS-174018-CCK216A MQIU-174018-HCU216A	1/4	1/2	20	15	φ 25×1.5
MQS-174024-CCK216A MQIU-174024-HCU216A	3/8	5/8	30	15	
MQS-174036-CCK216A MQIU-174036-HCU216A			30	15	
MQS-174048-CCK216A MQIU-174048-HCU216A			50	30	
MQS-174060-CCK216A MQIU-174060-HCU216A	3/8	3/4	50	30	

Notes:

- ①. The connection pipe should be insulated with proper water-proof insulating material.
- ②. The pipe wall thickness shall be 0.5-1.0 mm and the pipe wall shall be able to withstand the pressure of 6.0 MPa. The longer the connecting pipe, the lower the cooling and heating effect performs.

4.4 Electrical Requirement

Electric Wire Size and Fuse Capacity.

Table 3.5

Indoor Units	Power Supply	Fuse Capacity	Breaker Capacity	Min. Power Supply Cord
	V/Ph/Hz	A	A	mm ²
18K~60K	220-240V~ 60Hz	5	6	1.0

Table 3.6

Model	Power Supply	Capability of Air Switch(A)	Minimum Sectional Area Of Earth Wire (mm ²)
MQIU-174018-HCU216A	220-240V~ 60Hz	16	1.5
MQIU-174024-HCU216A		20	2.5
MQIU-174036-HCU216A		25	2.5
MQIU-174048-HCU216A		40	6.0
MQIU-174060-HCU216A		40	6.0

Notes:

- ①. The fuse is located on the main board.
- ②. Install the disconnect device with a contact gap of at least 3 mm in all poles nearby the units (Both indoor unit and outdoor unit).The appliance must be positioned so that the plug is accessible.
- ③. The specifications of the breaker and power cable listed in the Table above are determined based on the maximum power (maximum amps) of the unit.
- ④. The specifications of the power cable listed in the Table above are applied to the conduit-guarded multi-wire copper cable (like, YJV copper cable, consisting of PE insulated wires and a PVC cable jacket) used at 40°C and resistible to 90°C (see IEC 60364-5-52). If the working condition changes, they should be modified according to the related national standard.
- ⑤. The specifications of the breaker listed in the Table above are applied to the breaker with the working temperature at 40°C. If the working condition changes, they should be modified according to the related national standard.
- ⑥. Take 2 pieces of power cord of 0.75 mm² as the communication lines between indoor and outdoor unit, with their longest lengths of 50 m. Please select the appropriate line length as per the actual installation conditions. The communication lines can not be twisted together. For the unit (≤30K), it's recommended to use 8m long communication line.
- ⑦. Take 2 pieces of power cord of 0.75 mm² as the communication lines between

the wired controller and the indoor unit, with their longest lengths of 30m. Please select the appropriate line length as per the actual installation conditions. The communication lines can not be twisted together. It's recommended to use 8m long communication line.

- ⑧. The wire size of the communication line should be no less than 0.75mm^2 . It's recommended to take 0.75mm^2 power cords as the communication line.

5 Installation of the Unit

5.1 Installation of the Indoor Unit

5.1.1 Indoor unit dimension

For the units: 18K

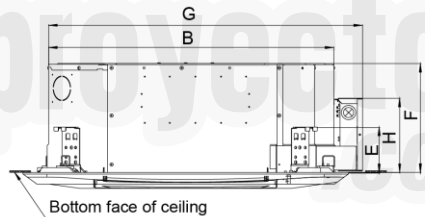
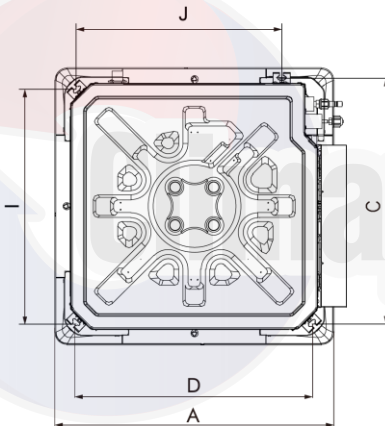

For the units: 24~36K

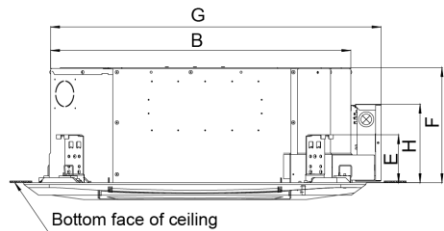
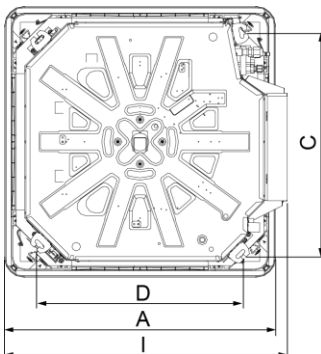

For the units:48~60K

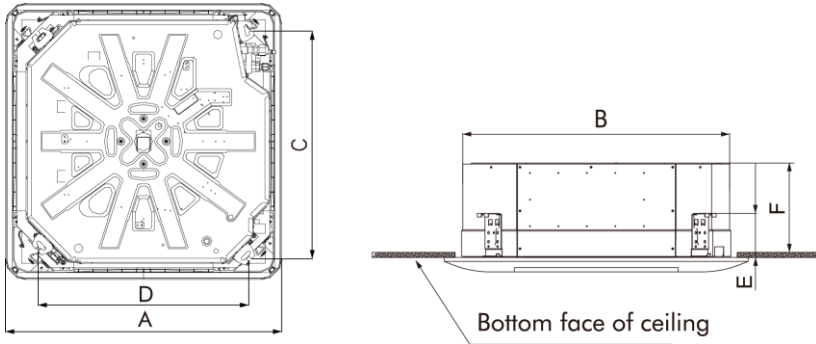

Fig. 4.1
Table 4.1

Model \ Item	A	B	C	D	E	F
MQS-174018-CCK216A	670	596	592	571	145	240
MQS-174024-CCK216A	950	840	780	680	160	240
MQS-174036-CCK216A	950	840	780	680	160	320
MQS-174048-CCK216A	1040	910	842	788	170	290
MQS-174060-CCK216A	1040	910	842	788	170	290

5.1.2 Installing the Main Body Unit

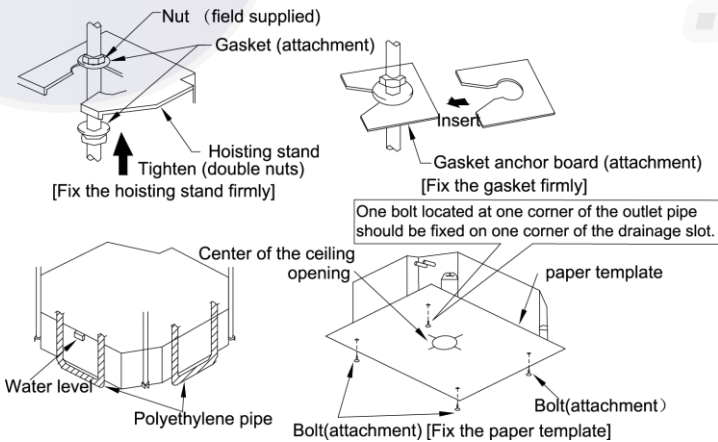

Fig. 4.2

- (1). Install the hoisting stand on the hoisting screw by using nuts and gaskets at both the upper and lower sides of the hoisting stand. To prevent the gasket

from breaking off, a gasket anchor board can be helpful.

- (2). Install the paper template on the unit, and fix the drain pipe at the outlet vent.
- (3). Adjust the unit to the best position.
- (4). Check if the unit is installed horizontally at four directions. If not, the water pump and the float switch would function improperly and even lead to water leakage.
- (5). Remove the gasket anchor board and tighten the nut remained.
- (6). Remove the paper template.

5.1.3 Installing the Suspension Bolts

- (1). Using the installation template, drill holes for bolts (four holes). (Fig. 4.3)
- (2). Install the bolts to the ceiling at a place strong enough to hang the unit. Mark the bolt positions from the installation template. With a concrete drill, drill for 12.7 mm (1/2") diameter holes. (Fig. 4.4)
- (3). Insert the anchor bolts into the drilled holes, and drive the pins completely into the anchor bolts with a hammer. (Fig. 4.5)

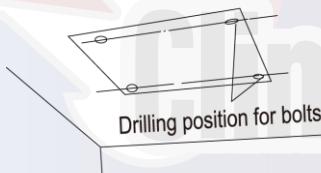

Fig. 4.3

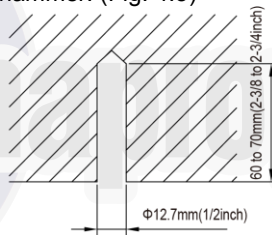

Fig. 4.4

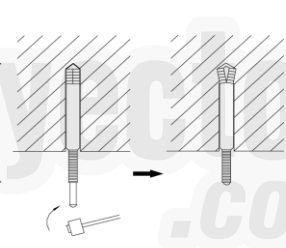

Fig. 4.5

5.1.4 Leveling

The water level test must be done after installing the indoor unit to make the unit is horizontal, as shown below.

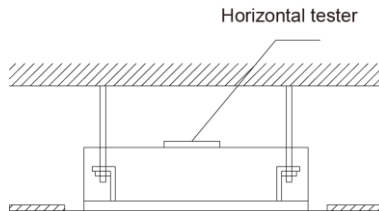



Fig. 4.6

5.2 Installation of the Outdoor Unit

 WARNING	
①.	Install the unit where it will not be tilted by more than 5°.
②.	During installation, if the outdoor unit has to be exposed to strong wind, it must be fixed securely.

5.2.1 Outdoor unit dimension

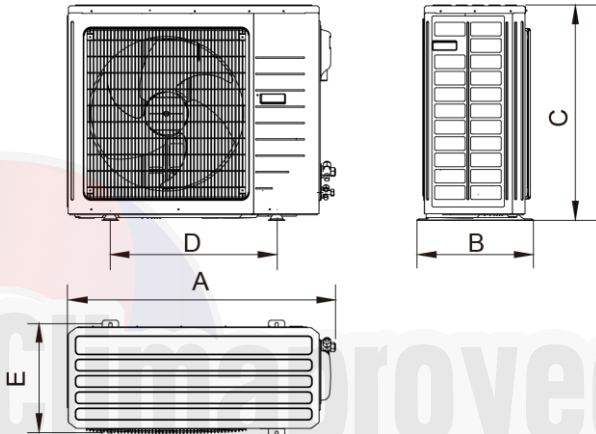

Fig. 4.7
Table 4.2

Unit: mm

Item Model	A	B	C	D	E
MQIU-174018-HCU216A	955	396	700	560	360
MQIU-174024-HCU216A	980	427	790	610	395
MQIU-174036-HCU216A	1107	440	1100	631	400
MQIU-174048-HCU216A	958	412	1349	572	376
MQIU-174060-HCU216A	1085	427	1365	620	395

5.2.2 Condensate Drainage of the Outdoor Unit (Only for the heat pump unit) (Fig. 4.8)

- (1). It is required to install a drain pipe for the outdoor unit to drain out the condensate water during heating operation. (only for the heat pump unit)
- (2). When installing the drain pipe, apart from the drain pipe mounting hole, all other holes should be plugged so as to avoid water leakage. (only for the heat pump unit)

- (3). Installation Method: Insert the pipe joint into the hole $\phi 25$ located at the base plate of the unit and then connect the drain pipe to the pipe joint.

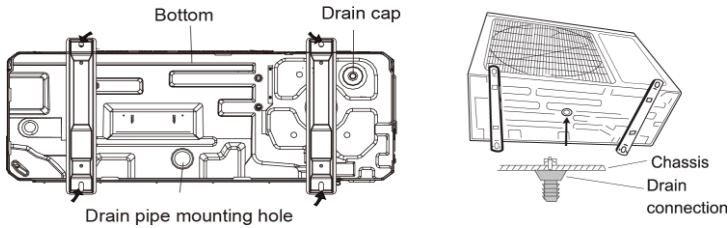

Fig. 4.8

5.3 Installation of the Connection Pipe

5.3.1 Flare Processing

- (1). Cut the connection pipe with the pipe cutter and remove the burrs.
- (2). Hold the pipe downward to prevent cuttings from entering the pipe.
- (3). Remove the flare nuts at the stop valve of the outdoor unit and inside the accessory bag of the indoor unit, then insert them to the connection pipe, after that, flare the connection pipe with a flaring tool.
- (4). Check if the flare part is spread evenly and there are no cracks (see Fig. 4.9).

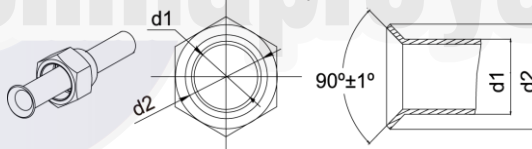

Fig. 4.9

5.3.2 Bending Pipes

- (1). The pipes are shaped by your hands. Be careful not to collapse them.

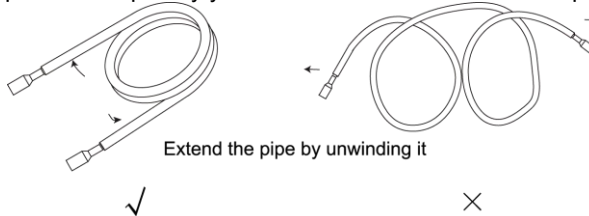

Fig. 4.10

- (1). Do not bend the pipes in an angle more than 90°.
- (2). When pipes are repeatedly bent or stretched, the material will harden, making it difficult to bend or stretch them any more. Do not bend or stretch the pipes more than three times.
- (3). When bending the pipe, do not bend it as is. The pipe will be collapsed. In this case, cut the heat insulating pipe with a sharp cutter as shown in Fig. 4.11, and bend it after exposing the pipe. After bending the pipe as you want, be sure to put the heat insulating pipe back on the pipe, and secure it with tape.

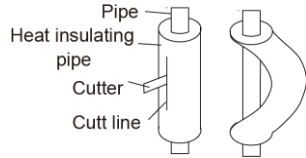

Fig. 4.11

⚠ CAUTION!

- | |
|--|
| ①. To prevent breaking of the pipe, avoid sharp bends. Bend the pipe with a radius of curvature of 150 mm or over. |
| ②. If the pipe is bent repeatedly at the same place, it will break. |

5.3.3 Connecting the Pipe at the Indoor Unit Side

Detach the caps and plugs from the pipes.

⚠ CAUTION!

- | |
|--|
| ①. Be sure to apply the pipe against the port on the indoor unit correctly. If the centering is improper, the flare nut cannot be tightened smoothly. If the flare nut is forced to turn, the threads will be damaged. |
| ②. Do not remove the flare nut until the connection pipe is to be connected so as to prevent dust and impurities from coming into the pipe system. |

When connecting the pipe to the unit or removing it from the unit, please do use both the spanner and the torque wrench.(Fig. 4.12)

When connecting, smear both inside and outside of the flare nut with refrigeration oil, screw it hand tight and then tighten it with the spanner.

Refer to Table 4.3 to check if the wrench has been tightened properly (too tight would mangle the nut and lead to leakage).

Examine the connection pipe to see if it leaks, then take the treatment of heat insulation, as shown in the Fig. 4.12.

Use the medium-sized sponge to insulate the coupler of the gas pipe.

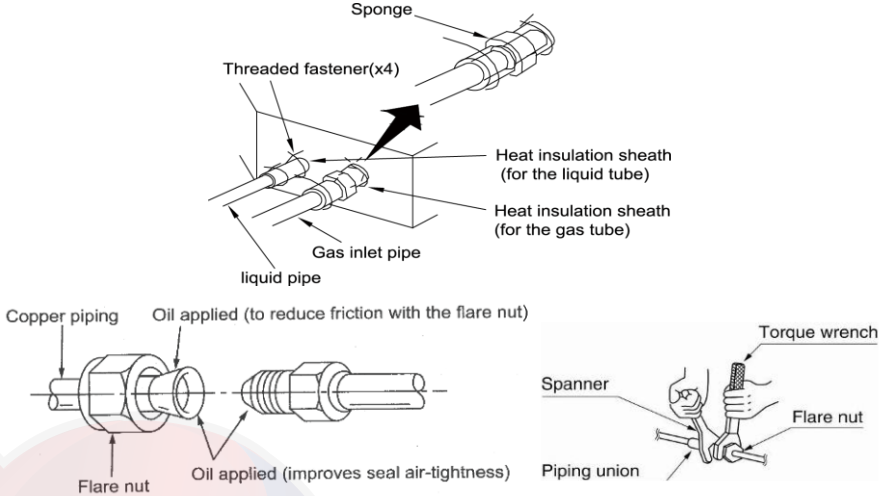

Fig. 4.12

Table 4.3 Flare nut tightening torque

Pipe Diameter	Tightening Torque
1/4 Inch)	15-30 (N·m)
3/8 Inch)	35-40 (N·m)
5/8 Inch)	60-65 (N·m)
1/2 Inch)	45-50 (N·m)
3/4 Inch)	70-75 (N·m)
7/8 Inch)	80-85 (N·m)



Be sure to connect the gas pipe after connecting the liquid pipe completely.

5.3.4 Connecting the Pipe at the Outdoor Side Unit

Tighten the flare nut of the connection pipe at the outdoor unit valve connector. The tightening method is the same as that as at the indoor side.

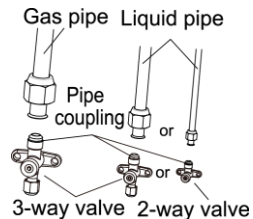

Fig. 4.13

5.3.5 Checking the Pipe Connections for Gas Leaking

For both indoor and outdoor unit side, check the joints for gas leaking by the use of a gas leakage detector without fail when the pipes are connected.

5.3.6 Heat Insulation on the Pipe Joints (Indoor Side Only)

Stick coupler heat insulation (large and small) to the place where connecting pipes.

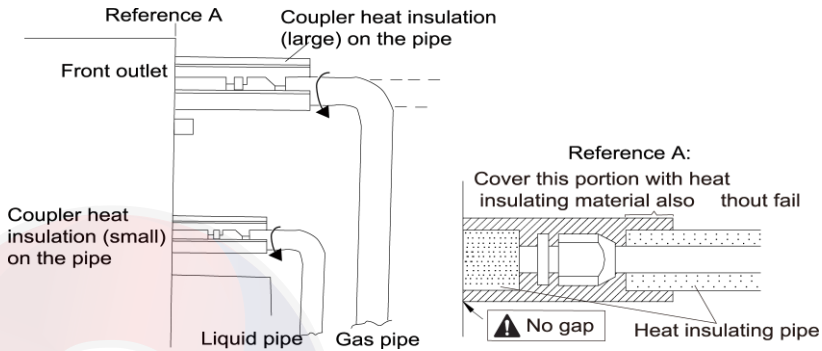

Fig. 4.14

5.3.7 Liquid Pipe and Drain Pipe

- (1). If the outdoor unit is installed lower than the indoor unit (See Fig. 4.15)
 - 1). A drain pipe should be above ground and the end of the pipe does not dip into water. All pipes must be restrained to the wall by saddles.
 - 2). Taping pipes must be done from bottom to top.
 - 3). All pipes are bound together by tape and restrained to wall by saddles.

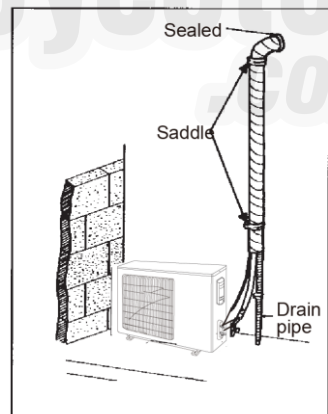

Fig. 4.15

- (2). If the outdoor unit is installed higher than the indoor unit (See Fig. 4.16)
 - 1). Taping should be done from lower to the upper part.
 - 2). All pipes are bound and taped together and also should be trapped to prevent water from returning to the room.
 - 3). Restraint all pipes to the wall with saddles.

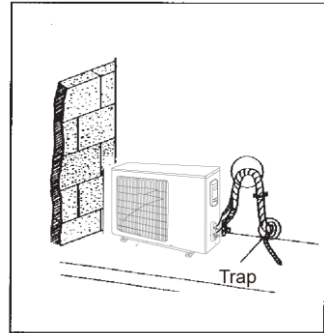

Fig. 4.16

5.4 Vacuum and Gas Leakage Inspection

CAUTION!

Do not purge the air with refrigerants but use a vacuum pump to vacuum the installation! There is no extra refrigerant in the outdoor unit for air purging!

5.4.1 Vacuum

- (1). Remove the caps of the liquid valve, gas valve and also the service port.
- (2). Connect the hose at the low pressure side of the manifold valve assembly to the service port of the unit's gas valve, and meanwhile the gas and liquid valves should be kept closed in case of refrigerant leak.
- (3). Connect the hose used for evacuation to the vacuum pump.
- (4). Open the switch at the lower pressure side of the manifold valve assembly and start the vacuum pump. Meanwhile, the switch at the high pressure side of the manifold valve assembly should be kept closed, otherwise evacuation would fail.
- (5). The evacuation duration depends on the unit's capacity, generally, 20 minutes for the 18K units, 30 minutes for the 24/36K units, 45 minutes for the 48/60K units. And verify if the pressure gauge at the low pressure side of the manifold valve assembly reads -1.0Mp (-75cmHg), if not, it indicates there is leak somewhere. Then, close the switch fully and then stop the vacuum pump.
- (6). Wait for some time to see if the system pressure can remain unchanged, 5 minutes for the 18/24K units, 10 minutes for the units 36~60K. During this time, the reading of the pressure gauge at the low pressure side can not be larger than 0.005Mp (0.38cmHg).
- (7). Slightly open the liquid valve and let some refrigerant go to the connection

pipe to balance the pressure inside and outside of the connection pipe, so that air will not come into the connection pipe when removing the hose. Note that the gas and liquid valve can be opened fully only after the manifold valve assembly is removed.

- (8). Place back the caps of the liquid valve, gas valve and also the service port.

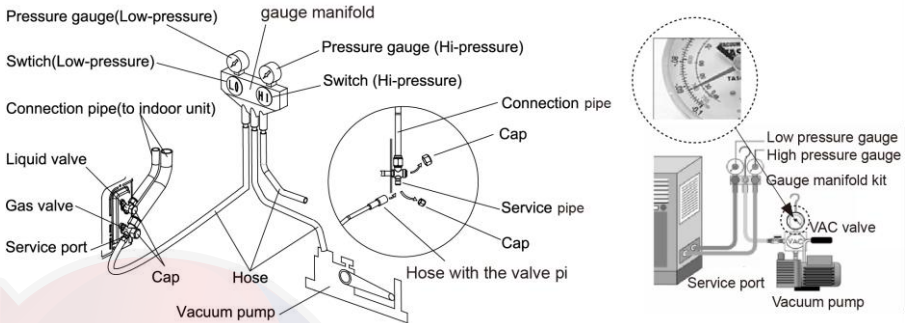

Fig. 4.17

Note: For the large-sized unit, it has the service port for both the gas valve and the liquid valve. During evacuation, it is available to connect two hoses of the manifold valve assembly to two service ports to quicken the evacuating speed.

5.4.2 Additional Charge

18K~36K: Refrigerant suitable for a piping length of 5m is charged in the outdoor unit at the factory. When the piping is longer than 7m, additional charging is necessary.

48~60K: Refrigerant suitable for a piping length of 7.5m is charged in the outdoor unit at the factory. When the piping is longer than 10 m, additional charging is necessary.

For the additional amount, see Table 4.4.

Table 4.4

Model	Item	Additional Refrigerant Amount for Extra Pipe
18K		30g/m
24~60K		60 g/m

When the height difference between the indoor unit and outdoor unit is larger than 10 meters, an oil bend should be employed for every 6 meters.

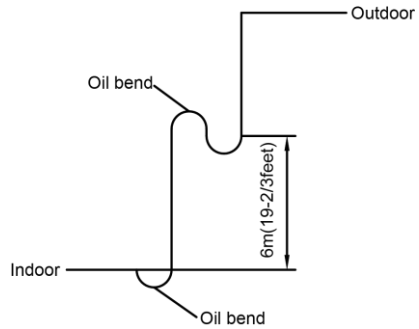

Fig. 4.18

5.5 Installation of the Drain Hose

5.5.1 Installation of Drain Piping

- (1). Keep piping as short as possible and slope it downwards at a gradient of at least 1/100 so that air may not remain trapped inside the pipe.
- (2). Keep pipe size equal to or greater than that of the connecting pipe.
- (3). Install the drain piping as shown and take measures against condensation. Improperly rigged piping could lead to leaks and eventually wet furniture and belongings.

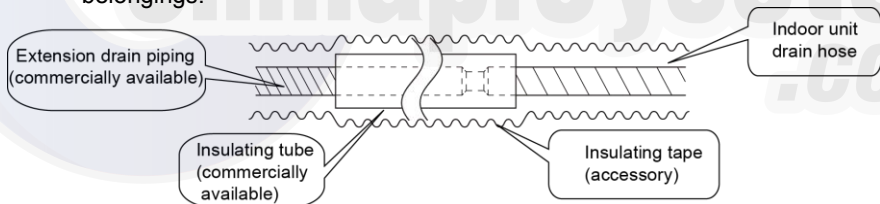
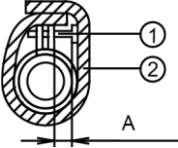
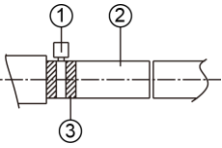

Fig. 4.19

5.5.2 Installing the Drain Pipes

- (1). Insert the drain pipe to the drain outlet of the unit and then tighten the clamp securely with tape.
- (2). Connect the extension drain pipe to the drain pipe and then tighten the clamp with tape.

	
<p>During the installation, distance from soft drain pipe to the gasket is A mm when the bolt is tightened. It is not allowed to apply PVC or other related glue in the joints of two ends of drain pipe.</p> <p>①. Metal clamp (accessory) ②. Insulation sponge (accessory)</p>	<p>Insulate the pipe clamp and the drain hose using heat insulation sponge.</p> <p>①. Metal clamp ②. Drain hose (accessory) ③. Grey tape (accessory)</p>

Indoor Unit	A
MQS-174018-CCK216A	10±2mm(2/5±2/25inch)
MQS-174024-CCK216A	15±3mm(3/5±1/10inch)
MQS-174036-CCK216A	
MQS-174048-CCK216A	
MQS-174060-CCK216A	

- (3). When unifying multiple drain pipes, install the pipes as Fig. 4.20. Select converging drain pipes whose gauge is suitable for the operating capacity of the unit. (take the cassette type unit for example)

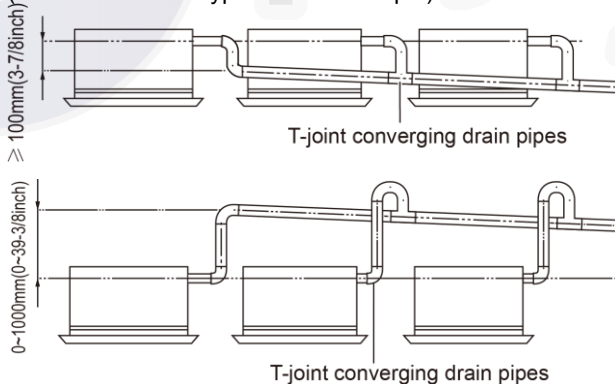

Fig. 4.20

- (4). When the drain hose cannot keep a sufficient gradient, it is necessary to fit a riser pipe (field supplied) to it.
- (5). If the air flow of indoor unit is high, this might cause negative pressure and result in return suction of outdoor air. Therefore, U-type water trap shall be

designed on the drainage side of each indoor unit.(Fig. 4.21)

- (6). Install one water trap for each unit.
- (7). Installation of water trap shall consider easy cleaning in the future.

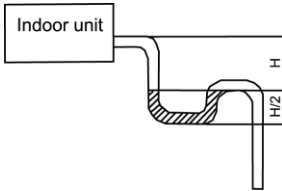

Fig. 4.21

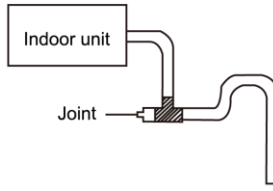

Fig. 4.22

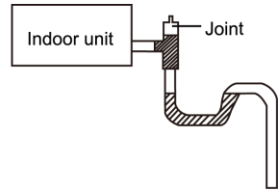

Fig. 4.23

- (8). Connection of drainage branch pipe to the standpipe or horizontal pipe of drainage main pipe

The horizontal pipe cannot be connected to the vertical pipe at a same height. It can be connected in a manner as shown below:

NO.1: Attach the 3-way connection of the drainage pipe joint as shown in Fig. 4.24.

NO.2: Attach the drain elbow as shown in Fig. 4.25.

NO.3: Attach the horizontal pipe as shown in Fig. 4.26.

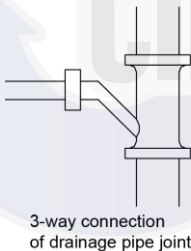

Fig. 4.24

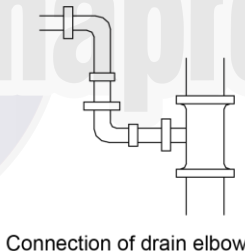

Fig. 4.25

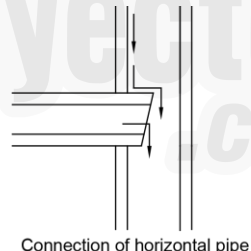

Fig. 4.26

4.5.3 Precautions When Doing Riser Piping Work

- (1). Make sure that heat insulation work is executed on the following 2 spots to prevent any possible water leakage due to dew condensation.
 - 1). Connect the drain hose to the drain lift pipe, and insulate them.
 - 2). Connect the drain hose to the drain outlet on the indoor unit, and tighten it with the clamp.

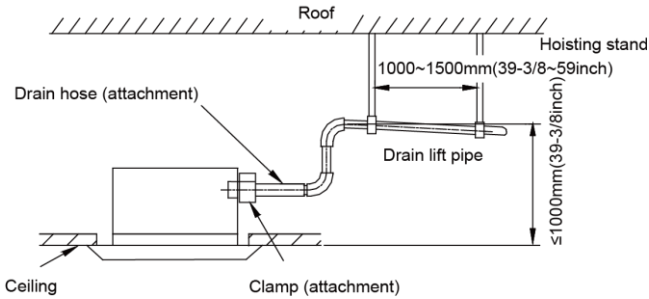

Fig. 4.27

- (2). Secure a downward gradient of 1/100 or more for the drain pipe. To accomplish this, mount supporting brackets at an interval of 1 - 1.5 m.

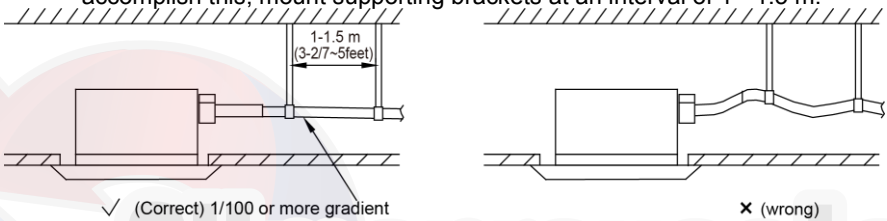

Fig. 4.28

4.5.4 Testing of Drain Piping

After piping work is finished, check if drainage flows smoothly.

Shown in the Fig. 4.29, Add approximately 1liter of water slowly into the drain pan and check drainage flow during COOL running.

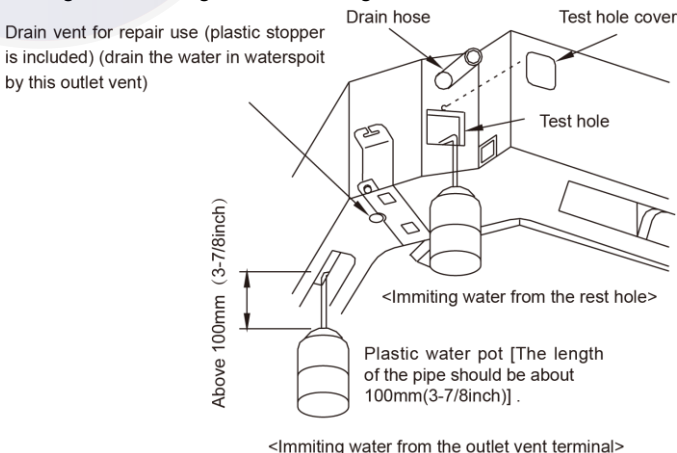

Fig. 4.29

5.6 The Panel Installation

5.6.1 Precautions

- (1). See the Figure below for the relationship of the front panel and the connecting pipe.

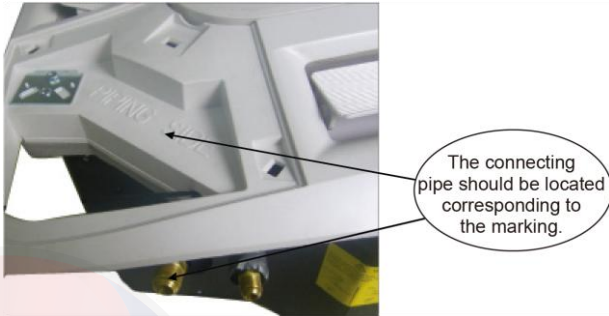

Fig. 4.31

- (2). Improper screwing of the screws may cause the troubles shown in Fig. 4.32.

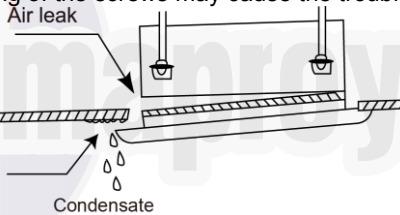

Fig. 4.32

- (3). If gap still exists between ceiling and decoration panel after tightening the screws, readjust the height of the indoor unit. (Fig. 4.33)

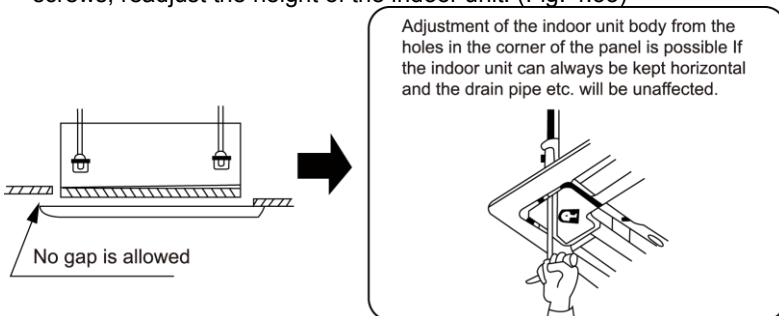

Fig. 4.33

- (1). Wire the swing flap motor and lamps to the main body according to the size of Terminals and the connection cord color as shown in Fig.36.

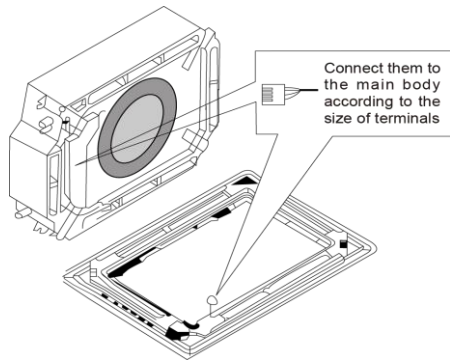

Fig. 4.34

5.6.2 Installing the Panel

- (1). Place the panel at the unit, and latch the hooks beside and opposite the swing flap motor.
- (2). Latch other two hooks.
- (3). Tighten four hexagonal screws under the latches about 15mm.
- (4). Adjust the panel along the direction indicated by the arrow as shown in Fig. 4.35.
- (5). Tighten the screws until the thickness of the sealing material between the panel and the indoor unit reduces to 5-8mm.

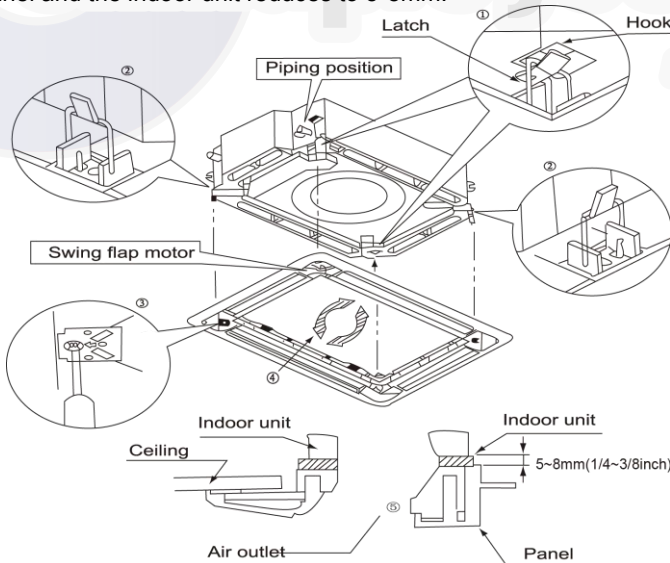



Fig. 4.35

5.7 Electrical Wiring

5.7.1 Wiring Precautions

 WARNING!	
①.	Before obtaining access to terminals, all supply circuits must be disconnected.
②.	The rated voltage of the unit is as shown as Table 3.5 and Table 3.6
③.	Before turning on, verify that the voltage is within the 198~264V range(for single phase unit).
④.	Always use a special branch circuit and install a special receptacle to supply power to the air conditioner.
⑤.	Use a special branch circuit breaker and receptacle matched to the capacity of the air conditioner.
⑥.	The special branch circuit breaker is installed in the permanent wiring. Always use a circuit that can trip all the poles of the wiring and has an isolation distance of at least 3 mm between the contacts of each pole.
⑦.	Perform wiring work in accordance with standards so that the air conditioner can be operated safely and positively.
⑧.	Install a leakage special branch circuit breaker in accordance with the related laws and regulations and electric company standards.

 CAUTION!	
①.	The power source capacity must be the sum of the air conditioner current and the current of other electrical appliances. When the current contracted capacity is insufficient, change the contracted capacity.
②.	When the voltage is low and the air conditioner is difficult to start, contact the power company to raise the voltage.

5.7.2 Electrical Wiring

- (1). For solid core wiring (Fig. 4.36)
 - 1). Cut the wire end with a wire cutter or wire-cutting pliers, then strip the insulation about 10 mm (15/16") .
 - 2). Using a screwdriver, remove the terminal screw(s) on the terminal board.
 - 3). Using pliers, bend the solid wire to form a loop suitable for the terminal screw.
 - 4). Shape the loop wire properly, place it on the terminal board and tighten securely with the terminal screw using a screwdriver.
- (2). For strand wiring (Fig. 4.36)
 - 1). Cut the wire end with a wire cutter or wire-cutting pliers, then strip the insulation about 10 mm (3/8") .
 - 2). Using a screwdriver, remove the terminal screw (s) on the terminal board.
 - 3). Using a round terminal fastener or pliers, securely clamp a round terminal to

each stripped wire end.

- 4). Position the round terminal wire, and replace and tighten the terminal screw with a screwdriver.(Fig. 4.37)

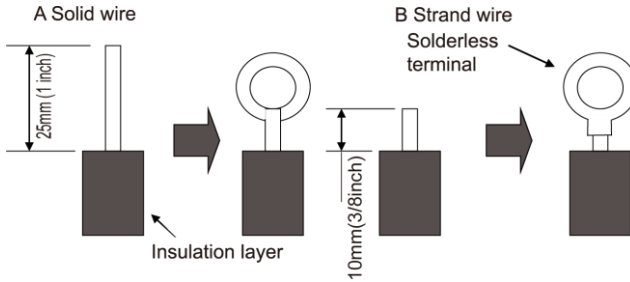

Fig. 4.36

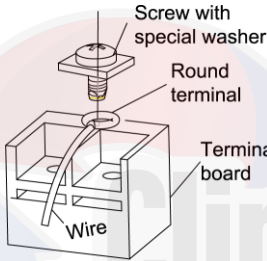

Fig. 4.37

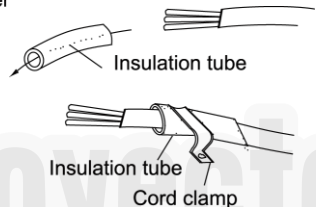
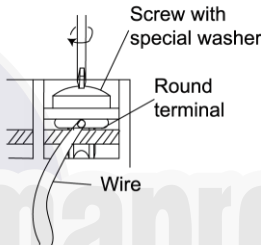

Fig. 4.38

- (3). How to fix connection cord and power cord by cord clamp

After passing the connection cord and power cord through the insulation tube, fasten it with the cord clamp.(Fig. 4.38)

⚠ WARNING!

- ①. Before starting work, check that power is not being supplied to the indoor unit and outdoor unit.
- ②. Match the terminal block numbers and connection cord colors with those of the indoor unit side. Erroneous wiring may cause burning of the electric parts.
- ③. Connect the connection cords firmly to the terminal block. Imperfect installation may cause a fire.
- ④. Always fasten the outside covering of the connection cord with cord clamps. (If the insulator is not clamped, electric leakage may occur.)
- ⑤. Always connect the ground wire.

(4). Electric wiring between the indoor and outdoor units

Single-phase units(18/24K)

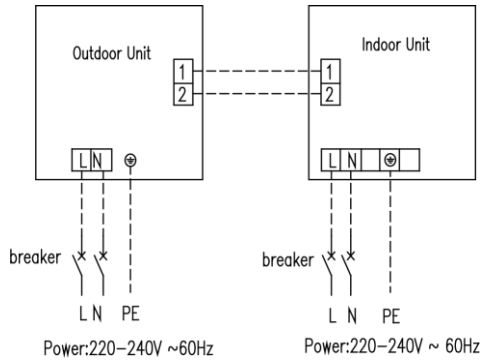

MQIU-174018-HCU216A+MQS-174018-CCK216A
①. Power cord $3 \times 1.5\text{mm}^2$ (H07RN-F)
②. Power cord $3 \times 1.0\text{mm}^2$ (H05RN-F)
③. Communication Cords $2 \times 0.75\text{mm}^2$ (H05RN-F)
MQIU-174024-HCU216A+MQS-174024-CCK216A
MQIU-174036-HCU216A+MQS-174036-CCK216A
①. Power cord $3 \times 2.5\text{mm}^2$ (H07RN-F)
②. Power cord $3 \times 1.0\text{mm}^2$ (H05RN-F)
③. Communication Cords $2 \times 0.75\text{mm}^2$ (H05RN-F)

Single-phase units(36~60K)

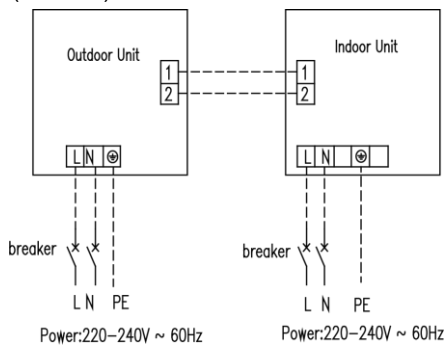

MQIU-174048-HCU216A+MQS-174048-CCK216A
MQIU-174060-HCU216A+MQS-174060-CCK216A
①. Power cord $3 \times 6.0\text{mm}^2$ (H07RN-F)
②. Power cord $3 \times 1.0\text{mm}^2$ (H05RN-F)
③. Communication Cords $2 \times 0.75\text{mm}^2$ (H05RN-F)

Fig. 4.39

(5). Electric wiring of indoor unit side

Remove the electric box cover from the electric box sub-assy and then connect the wire.

For the units: 18K

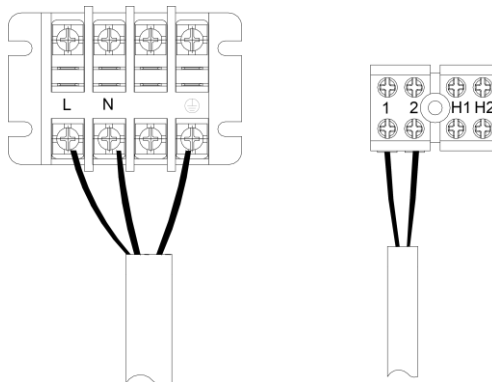
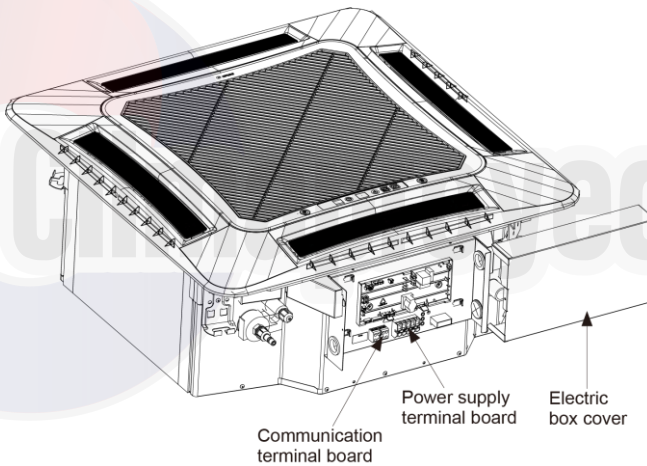

For the units: 24~60K

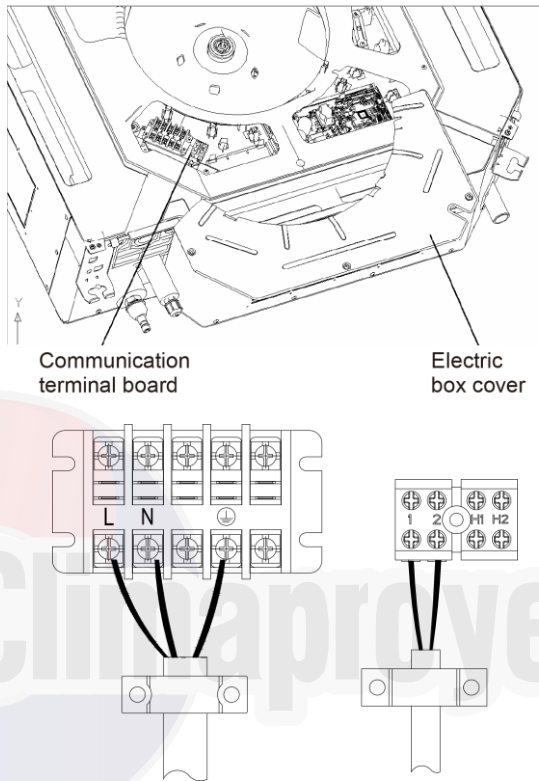

Fig. 4.40

⚠ CAUTION!

- ①. The power cord and the wire of the fresh air valve are high-voltage, while the communication cord and connection wire of the wired controller are low-voltage. They should run separately against electromagnetic interference.
- ②. The high-voltage and low-voltage lines should pass through the rubber rings at different electric box covers.
- ③. Do not bundle the connection wire of the wired controller and the communication cord together, or arrange them in parallel, otherwise improper operation would occur.
- ④. The high-voltage and low-voltage lines should be fixed separately and securely, with internal big clamps for the former and small clamps for the latter.
- ⑤. Tighten the indoor/outdoor connection cord and power cord respectively on the terminal boards with screws. Faulty connection may cause a fire.
- ⑥. If the indoor unit connection cord (to the outdoor unit) and power supply are wired incorrectly, the air conditioner may be damaged.

- | |
|---|
| ⑦. Connect the indoor unit connection cord properly based on the corresponding marks as shown in Fig. 4.39. |
| ⑧. Ground both the indoor and outdoor units by attaching a ground wire. |
| ⑨. Unit shall be grounded in compliance with the applicable local and national codes. |

(6). Electric wiring of outdoor unit side

Note: When connecting the power supply cord, make sure that the phase of the power supply matches with the exact terminal board. If not, the compressor will rotate reversely and run improperly.

Remove the big handle (18/24K) /front board(36~60K) of the outdoor unit and insert the end of the communication cord and the power cable into the terminal board.

Single phase:

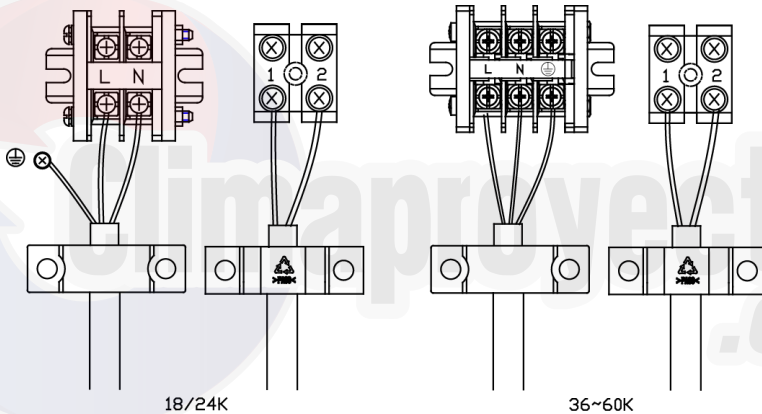

Fig. 4.41

6 Installation of Controllers

Refer to the Installation Manual of the controller for more details.

7 Test Running

7.1 Trial Operation and Testing

- (1). The meaning of error codes as shown below:

Table 6.1

Number	Error code	Error	Remarks
1	E1	Compressor high pressure protection	
2	E2	Indoor anti-freeze protection	
3	E3	Compressor low pressure protection, refrigerant lack protection and refrigerant collecting mode	
4	E4	Compressor high discharge temperature protection	
5	E6	Communication error	
6	E8	Indoor fan motor error	
7	E9	Full water protection	
8	F0	Indoor ambient temperature sensor error	
9	F1	Evaporator temperature sensor error	
10	F2	Condenser temperature sensor error	
11	F3	Outdoor ambient temperature sensor error	
12	F4	Discharge temperature sensor error	
13	F5	Temperature sensor error of wired controller	
14	EE	Outdoor memory chip error	
15	PF	Electric box sensor error	
16	H3	Compressor overload protection	
17	H4	Overloading	
18	H5	IPM protection	
19	H6	DC fan motor error	
20	H7	Drive desynchronizing protection	
21	Hc	Pfc protection	
22	Lc	Activation failure	
23	Ld	Compressor phase sequence protection	
24	LE	Compressor stalling protection	
25	LF	Power protection	
26	Lp	Indoor and outdoor mismatch	
27	U7	4-way valve direction changing protection	
28	P0	Drive reset protection	

29	P5	Over-current protection	
30	P6	Communication error between main control and drive	
31	P7	Drive module sensor error	
32	P8	Drive module over temperature protection	
33	P9	Zero passage protection	
34	PA	AC current protection	
35	Pc	Drive current error	
36	Pd	Sensor connecting protection	
37	PE	Temperature drift protection	
38	PL	Bus low voltage protection	
39	PH	Bus high voltage protection	
40	PU	Charge loop error	
41	PP	Input voltage abnormality	
42	ee	Drive memory chip error	
43	C4	Outdoor unit capacity code error	
44	C5	Indoor unit capacity code error	

Note: When the unit is connected with the wired controller, the error code will be simultaneously shown on it.

(2). Instructions to the Error Indicating Lamps on the Panel of the Cassette Type Unit.

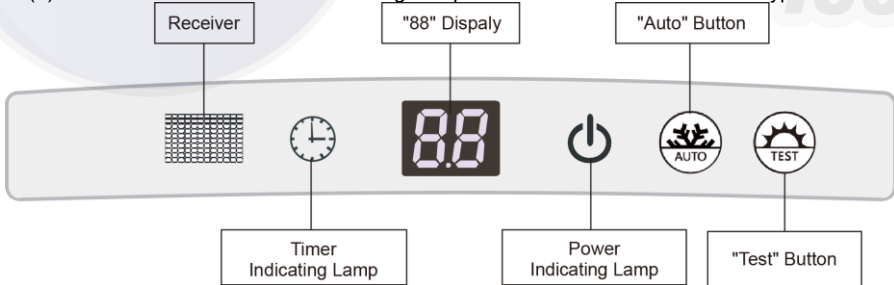

Fig.42

1). Power and ON/OFF Indicating Lamp:

It goes red when the unit is powered on while it goes white when the unit is started.

2). Timer Indicating Lamp:

It goes on when the timer is set and goes off when it is not. Its display is in yellow.

3). "88" Display:

When there is no error, and it receives valid remote control information. It will display the temp setup for 5s, then display the temp of indoor. When the unit has error, It will display the error code. When there are more than one error, the error code will be displayed alternately.

After the grille of the front panel is opened, the front panel is still allowed to realize the following functions by pressing the “Auto” button and the nearby “Test” button simultaneously for five seconds when the unit is “Off”.

7.2 Working Temperature Range

Table 6.2

Test Condition	Indoor Side		Outdoor Side	
	DB(°C)	WB(°C)	DB(°C)	WB(°C)
Nominal Cooling	27	19	35	24
Nominal Heating	20	-	7	6
Rated Cooling	32	23	48	-
Low Temp. Cooling	21	15	-15	-
Rated Heating	27	-	24	18
Low Temp. Heating	20	-	-10	-11

Note:

- ①. The design of this unit conforms to the requirements of ISO5151 standard.
- ②. The air volume is measured at the relevant standard external static pressure.
- ③. Cooling (heating) capacity stated above is measured under nominal working conditions corresponding to standard external static pressure. The parameters are subject to change with the improvement of products, in which case the values on nameplate shall prevail.

8 Troubleshooting and Maintenance

8.1 Troubleshooting

If your air-conditioning unit suffers from abnormal operation or failure, please first check the following points before repair:

Table 7.1

Failure	Possible Reasons
The unit cannot be started.	①. The power supply is not connected. ②. Electrical leakage of air-conditioning unit causes tripping of the leakage switch. ③. The operating keys are locked. ④. The control loop has failure.
The unit operates for a while and then stops.	①. There is obstacle in front of the condenser. ②. The control loop is abnormal. ③. Cooling operation is selected when the outdoor ambient temperature is above 48°C.
Poor cooling effect.	①. The air filter is dirty or blocked. ②. There is heat source or too many people inside the room. ③. The door or window is open. ④. There is obstacle at the air intake or outlet. ⑤. The set temperature is too high. ⑥. There is refrigerant leakage. ⑦. The performance of room temperature sensor becomes worse
Poor heating effect	①. The air filter is dirty or blocked. ②. The door or window is not firmly closed. ③. The set room temperature is too low. ④. There is refrigerant leakage. ⑤. The outdoor ambient temperature is lower than -5°C. ⑥. Control loop is abnormal.

Note: After carrying out the check of the above items and taking relevant measures to solve the problems but the air-conditioning unit still does not function well, please stop the operation of the unit immediately and contact the local service agency. Only ask professional serviceman to check and repair the unit.

8.2 Routine Maintenance

Only a qualified service person is allowed to perform maintenance.

Before accessing to terminal devices, all power supply circuits must be disconnected.

Do not use water or air of 50°C or higher for cleaning air filters and outside panels.



Notes:

- ①. Do not operate the air conditioner with the filter uninstalled, otherwise dust would come into the unit.
- ②. Do not remove the air filter except for cleaning. Unnecessary handling may damage the filter.



- ③. Do not clean the unit with gasoline, benzene, thinner, polishing powder or liquid insecticide, otherwise it would cause discoloration and deformation of the unit.
- ④. Do not wet the indoor unit in case of electric shock or fire hazard.

Increase the frequency of cleaning if the unit is installed in a room where the air is extremely contaminated. (As a yardstick for yourself, consider cleaning the filter once a half year.)

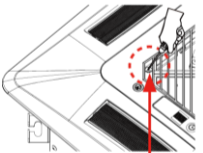
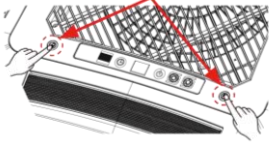
If dirt becomes impossible to clean, change the air filter.

How to clean the air filter	
<p>1. Open the air inlet grille</p> <p>(1) How to open the panel grille of the 24/36K cassette type unit</p> <ul style="list-style-type: none"> ①. Push the buckle as shown in the Figure. ②. Release the screws under buckles by a screwdriver. ③. Push the fastener and open the panel grille. 	<div style="display: flex; justify-content: space-around;">  </div> <p style="text-align: center;">Remove the screw</p> <div style="text-align: center;">  </div> <p style="text-align: center;">Push the fastener</p>
<p>(2) How to open the panel grille of the 18K\48K cassette type unit</p> <ul style="list-style-type: none"> ①. Remove the screws by a screwdriver as shown in the picture. ②. Push those two fasteners and open the panel grille. 	<div style="text-align: center;">  </div> <p style="text-align: center;">Remove the screw</p> <div style="text-align: center;">  </div> <p style="text-align: center;">Push the fastener</p>

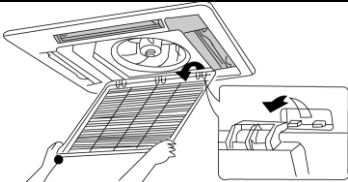
DC Inverter U-match Series Cassette Type Unit

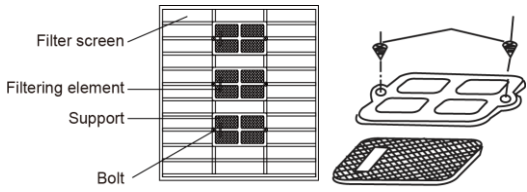
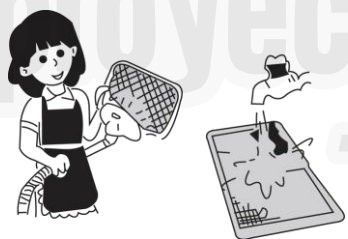
<p>2. Disassemble the air inlet grille Open the air inlet grille at 45°, raise it and remove the grille.</p>	
<p>3. Disassemble the filter screen Draw out the filter screen and remove it.</p>	
<p>4. Disassemble the air purifier Remove the air purifier after removing the fixed screws on it.</p>	
<p>5. Clean the filter screen Clean the filter screen by a vacuum cleaner or wash it by flashing water. If the oil stain on the filter can not be removed or cleaned up, wash it by warm water meld with the detergent. Dry the filter in the shadow.</p> <p>Note:</p> <ol style="list-style-type: none"> ①. Never use hot water over 45°C in case of color fading or turning yellow. ②. Never dry it by fire so as to prevent the filter caught fire or deformation. 	
<p>6. Reset the filter</p>	<p>The same as step 3</p>
<p>7. Install the grille well</p>	<p>The same as step 1 and 2</p>

