

58SB0A/58SB1A
4-WAY MULTIPOISE Non-Condensing
33-1/3 in. GAS FURNACE
Input Capacities: 45,000 thru 155,000 Btuh

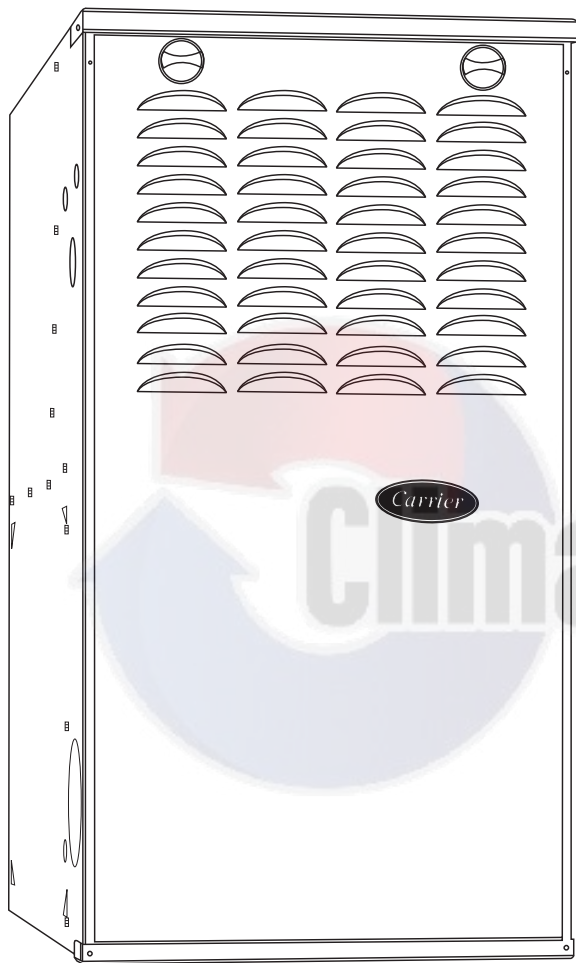

Product Data



A10247

THE 58SB0A/58SB1A GAS FURNACE

The 58SB0A/58SB1A Comfort™ Series 4-way Multipoise Gas Furnaces feature Carrier's QuietTech™ noise reduction system for incredibly quiet induced draft operation. Applications are easy with 4-way multipoise design, through-the-furnace downflow venting, 13 different venting options, and designed for easy service access. An inner blower door is provided for tighter sealing in sensitive applications. The 58SB0A/58SB1A furnaces are approved for use with natural or propane gas, and the 58SB1A - Low NOx units are designed for California installations and meet 40 ng/J NOx emissions. Can be installed in air quality management districts with a 40 ng/J NOx emissions requirement.



Comfort
SERIES



Use of the AHRI Certified™ Mark indicates a manufacturer's participation in the program. For verification of certification for individual products, go to www.ahridirectory.org.

PERFORMANCE

- Single Stage gas valve
- Fixed Speeds, Constant Torque (FCT) ECM blower motor
- QuietTech™ noise reduction system
- Microprocessor based control center
- Enhanced diagnostics with LED and reflective sight glass
- Stores fault codes during power outages
- Adjustable heating air temperature rise
- Adjustable cooling airflow
- Power Heat™ Igniter
- Draft safeguard switch to ensure proper furnace venting
- Inner door for tighter sealing

INSTALLATION FLEXIBILITY

- 4-way Multipoise furnace, 13 vent applications
- HYBRID HEAT® Dual Fuel System compatible
- All models are chimney friendly when used with accessory vent kit

APPLICATIONS

- Compact design - only 33-1/3 in. (847 mm) tall
- Propane convertible with gas conversion accessory
- Convenient Air Purifier and Humidifier connections

CERTIFICATION

- Cabinet air leakage less than 2.0% at 1.0 in. W.C. and cabinet air leakage less than 1.4% at 0.5 in. W.C. when tested in accordance with ASHRAE standard 193
- Residential installations eligible for consumer financing through the Retail Credit Program

SPECIFICATIONS

UNIT SIZE		045E14-12	045E17-12	070E14-12	070E17-12	070E21-16	090E17-14
RATINGS AND PERFORMANCE							
Input Btuh*	All Standard	44,000	44,000	66,000	66,000	66,000	88,000
	All Low NOx Upflow						
Nonweatherized ICS	All Low Nox	42,000	42,000	63,000	63,000	63,000	84,000
	Downflow/Horizontal						
Output Capacity (Btuh)†	All Standard	36,000	35,000	54,000	54,000	53,000	71,000
	All Low NOx Upflow						
Nonweatherized ICS	All Low Nox	34,000	34,000	51,000	51,000	51,000	68,000
	Downflow/Horizontal						
AFUE‡		80.00	80.00	80.00	80.00	80.00	80.00
Certified Temperature Rise Range – °F (°C)		30–60 (17–33)	30–60 (17–33)	30–60 (17–33)	35–65 (19–36)	25–55 (14–30)	40–70 (22–39)
Certified External Static Pressure	Heat/Cool	0.10/0.50	0.10/0.50	0.12/0.50	0.12/0.50	0.12/0.50	0.15/0.50
Airflow CFM‡	Heating	710	760	1090	985	1305	1203
	Cooling	1080	1215	1070	1005	1545	1210
ELECTRICAL							
Unit Volts–Hertz–Phase		115–60–1					
Operating Voltage Range	Min–Max	104–127					
Maximum Unit Amps		5.6	7.6	5.6	5.6	10.0	8.3
Unit Ampacity		7.8	10.3	7.8	7.8	13.3	11.0
Maximum Wire Length (Measure 1 Way in Ft (M))		47 (14.3)	36 (11)	47 (14.3)	47 (14.3)	27 (8.2)	33 (10.1)
Minimum Wire Size		14					
Maximum Fuse or Ckt Bkr Size (Amps)**		15					
Transformer (24v)		40va					
External Control	Heating	12va					
Power Available	Cooling	35va					
Air Conditioning Blower Relay		Standard					
CONTROLS							
Heating Blower Control		Solid State Time Operation					
Burners (Monoport)		2	2	3	3	3	4
Gas Connection Size		1/2in. NPT					
GAS CONTROLS							
Gas Valve (Redundant)	Mfr.	WhiteRodgers					
	Min. inlet pressure (In. W.C.)	4.5 (Natural Gas)					
	Max. inlet pressure (In. W.C.)	13.6 (Natural Gas)					
Ignition Device		Hot Surface					
Factory installed orifice		Size 43					
BLOWER DATA							
Direct Drive Motor HP		1/3	1/2	1/3	1/3	3/4	1/2
Motor Full Load Amps		4.4	6.4	4.4	4.4	8.8	6.8
RPM (Nominal)Speeds		1050–5	1050–5	1050–5	1050–5	1050–5	1050–5
Blower Wheel Diameter x Width – In. (mm)		10 x 6 (254 x 152)	10 x 8 (254 x 203)	11 x 8 (279 x 203)	11 x 8 (279 x 203)	10 x 10 (254 x 254)	11 x 8 (279 x 203)

* Gas input ratings are certified for elevations to 2000 ft. (610 M). In USA, For elevations above 2000 ft (610 M), reduce ratings 4 percent for each 1000 ft (305 M) above sea level. Refer to National Fuel Gas Code NFPA 54/ANSI Z223.1 Table F.4 or furnace installation instructions.

† Capacity in accordance with U.S. Government DOE test procedures.

‡ Airflow shown is for bottom only return-air supply for the as-shipped speed tap. For air delivery above 1800 CFM, see Air Delivery table for other options. A filter is required for each return-air supply. An airflow reduction of up to 7 percent may occur when using the factory-specified 4-5/16-in. (110 mm) wide, high efficiency media filter.

** Time–delay type is recommended.

ICS Isolated Combustion System

SPECIFICATIONS (continued)

UNIT SIZE		090E21-16	090E21-20	090E24-20	110E21-20	110E24-20	135E24-20	155E24-20
RATINGS AND PERFORMANCE								
Input Btuh*	All Standard All Low NOx Upflow	88,000	88,000	88,000	110,000	110,000	132,000	154,000
Nonweatherized ICS	All Low Nox Downflow/Horizontal	84,000	84,000	84,000	105,000	105,000	126,000	147,000
Output Capacity (Btuh)†	All Standard All Low NOx Upflow	72,000	71,000	72,000	90,000	90,000	107,000	125,000
Nonweatherized ICS	All Low Nox Downflow/Horizontal	68,000	68,000	69,000	85,000	86,000	102,000	119,000
AFUE‡		80.00	80.00	80.00	80.00	80.00	80.00	80.00
Certified Temperature Rise Range °F (°C)		35-65 (19-36)	25-55 (14-30)	30-60 (17-33)	30-60 (17-33)	30-60 (17-33)	40-70 (22-39)	45-75 (25-41)
Certified External Static Pressure	Heat/Cool	0.15/0.50	0.15/0.50	0.15/0.50	0.20/0.50	0.20/0.80	0.20/0.50	0.20/0.50
Airflow CFM‡	Heating	1418	1650	1565	1890	1930	1760	1995
	Cooling	1445	1980	1960	2040	2005	1810	1965
ELECTRICAL								
Unit Volts-Hertz-Phase		115-60-1						
Operating Voltage Range	Min-Max	104-127						
Maximum Unit Amps		8.3	13	10.3	13.4	10.7	10.7	10.7
Unit Ampacity		11	16.90	13.50	17.40	14	14	14
Maximum Wire Length (Measure 1 Way in Ft (M))		33 (10.1)	34 (10.4)	27 (8.2)	33 (10.1)	26 (7.9)	26 (7.9)	26 (7.9)
Minimum Wire Size		14	12	14	12	14	14	14
Maximum Fuse or Ckt Bkr Size (Amps)**		15	20	20	15	20	20	20
Transformer (24v)		40va						
External Control	Heating	12va						
Power Available	Cooling	35va						
Air Conditioning Blower Relay		Standard						
CONTROLS								
Heating Blower Control		SolidState Time Operation						
Burners (Monoport)		4	4	4	5	5	6	7
Gas Connection Size		1/2in. NPT						
GAS CONTROLS								
Gas Valve (Redundant)	Mfr.	WhiteRodgers						
	Min. inlet pressure (In. W.C.)	4.5 (Natural Gas)						
	Max. inlet pressure (In. W.C.)	13.6 (Natural Gas)						
Ignition Device		Hot Surface						
Factory installed orifice		Size 43						
BLOWER DATA								
Direct Drive Motor HP		1/2	1	3/4	1	3/4	3/4	3/4
Motor Full Load Amps		6.80	11.50	8.80	11.50	8.80	8.80	8.80
RPM (Nominal)Speeds		1050-5	1050-5	1050-5	1050-5	1050-5	1050-5	1050-5
Blower Wheel Diameter x Width - In. (mm)		10 x 10 (254 x 254)	11 x 11 (279 x 279)	11 x 11 (279 x 279)	11 x 11 (279 x 279)	11 x 11 (279 x 279)	11 x 11 (279 x 279)	11 x 11 (279 x 279)

* Gas input ratings are certified for elevations to 2000 ft. (610 M). In USA, for elevations above 2000 ft. (610 M), reduce ratings 4 percent for each 1000 ft. (305 M) above sea level. Refer to National Fuel Gas Code NFPA 54/ANSI Z223.1 Table F.4 or furnace installation instructions.

† Capacity in accordance with U.S. Government DOE test procedures.

‡ Airflow shown is for bottom only return-air supply for the as-shipped speed tap. For air delivery above 1800 CFM, see Air Delivery table for other options. A filter is required for each return-air supply. An airflow reduction of up to 7 percent may occur when using the factory-specified 4-5/16-in. (110 mm) wide, high efficiency media filter.

** Time-delay type is recommended.

ICS Isolated Combustion System

MODEL NUMBER NOMENCLATURE

1, 2 Gas Furnace	3 Heating Stages	4 Tier	5 Min. AFUE/NOx	6 Major Series	7, 8, 9 Heating Input	10 Motor Type	11, 12 Width	13 Voltage (1-phase)	14 Minor Series	15, 16 Airflow
58 Non-Condensing 59 = 90%+ Condensing	M M = Modulating S = Single Stage T = Two Stage	N B = Base C = Comfort E = Export N = Infinity P = Performance U = Ultra Low Nox	7 0 = Std. NOx 80% 1 = 80% Low Nox --- 2 = 92% 5 = 95% 6 = 96% 7 = 97% 8 = 98%	B	026 = 26,000 BTU 040 = 40,000 BTU 060 = 60,000 BTU --- 155 = 155,000 BTU	E C = Comm. Variable-Speed Constant Airflow (VCA) ECM E = Fixed-Speeds Constant Torque (FCT) ECM V = Variable-Speed Constant Torque (VCT) ECM	17 14 - 14.2" 17 - 17.5" 21 - 21.0" 24 - 24.5"	1 1 = 110V/60Hz 2 = 230V/50Hz	1 1 2 3 ---	16 08 = 800 CFM 10 = 1000 CFM 12 = 1200 CFM 14 = 1400 CFM 16 = 1600 CFM 20 = 2000 CFM 22 = 2200 CFM

A190041

For California Residents:

For installation in SCAQMD only: This furnace does not meet the SCAQMD Rule 1111 14 ng/J NOx emission limit, and thus is subject to a mitigation fee of up to \$450. This furnace is not eligible for the Clean Air Furnace Rebate Program: www.CleanAirFurnaceRebate.com

FURNACE COMPONENTS

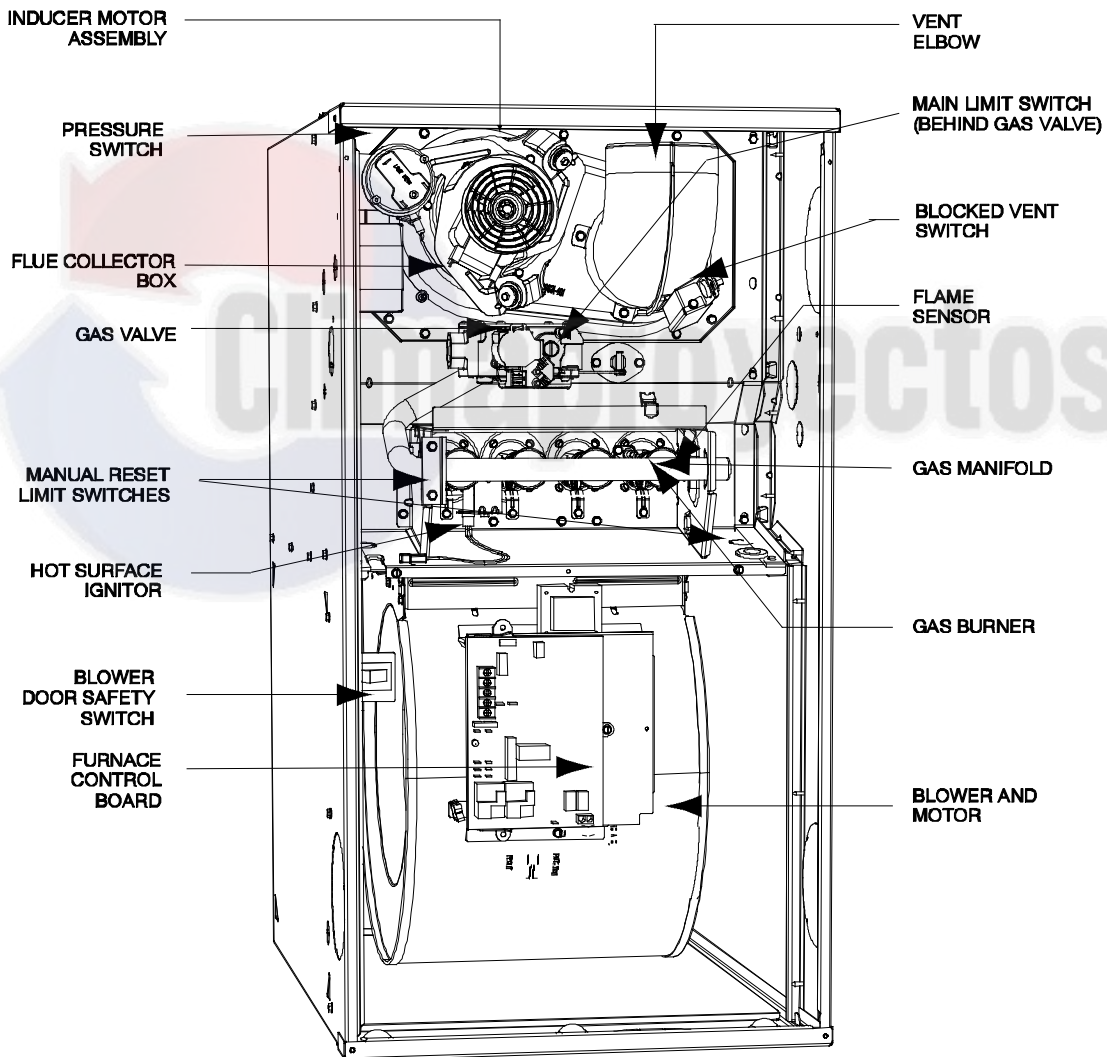

A190086

NOTE: The furnaces are factory shipped for use with natural gas. These furnaces can be field-converted for propane gas with a factory-authorized and listed accessory conversion kit.

ACCESSORIES

DESCRIPTION	PART NO.	045E14-12	045E17-12	070E14-12	070E17-12	070E21-16	090E17-14
External Bottom Return Filter Rack	KGBFR0401B14	X		X			
	KGBFR0501B17		X		X		X
	KGBFR0601B21					X	
Unframed Filter 3/4-in. (19 mm)	KGAWF1306UFR	X	X	X	X		X
	KGAWF1406UFR					X	
Flue Extension	KGAFE0112UPH	X	X	X	X	X	X
Combustible Floor Base	KGASB0201ALL	X	X	X	X	X	X
Downflow Vent Guard	KGBVG0101DFG	X	X	X	X	X	X
Vent Extension Kit	KGAVE0101DNH	X	X	X	X	X	X
Chimney Adapter Kit	KGACA02014FC	X	X	X	X	X	X
	KGACA02015FC						
Natural-to-Propane Conversion Kit*	AGAGC8NPS01A	X	X	X	X	X	X
Propane-to-Natural Conversion Kit	AGAGC8PNS01A	X	X	X	X	X	X
Blower Speed Tap Jumper Kit (10 pack)	AGABLRJMP10A	X	X	X	X	X	X

* Factory-authorized and field installed. Fuel conversion kits are CSA (formerly AGA/CGA) recognized.
X = Accessory

DESCRIPTION	PART NO.	090E21-16	090E21-20	090E24-20	110E21-20	110E24-20	135E24-20	155E24-20
External Bottom Return Filter Rack	KGBFR0601B21	X	X		X			
	KGBFR0701B24			X		X	X	X
	KGAWF1406UFR	X	X		X			
Unframed Filter 3/4-in. (19 mm)	KGAWF1506UFR			X		X	X	X
	KGAWF1406UFR	X	X		X			
Flue Extension	KGAFE0112UPH	X	X	X	X	X	X	X
Combustible Floor Base	KGASB0201ALL	X	X	X	X	X	X	X
Downflow Vent Guard	KGBVG0101DFG	X	X	X	X	X	X	X
Vent Extension Kit	KGAVE0101DNH	X	X	X	X	X	X	X
Chimney Adapter Kit	KGACA02014FC	X	X	X	X	X		
	KGACA02015FC						X	X
Natural-to-Propane Conversion Kit*	AGAGC8NPS01A	X	X	X	X	X	X	X
Propane-to-Natural Conversion Kit	AGAGC8PNS01A	X	X	X	X	X	X	X
Blower Speed Tap Jumper Kit (10 pack)	AGABLRJMP10A	X	X	X	X	X	X	X

* Factory-authorized and field installed. Fuel conversion kits are CSA (formerly AGA/CGA) recognized.
X = Accessory

ORIFICES		
Gas Orifice	LH32DB207	See Installation Instructions for model, altitude, and heat value usages.
	LH32DB202	
	LH32DB200	
	LH32DB205	
	LH32DB208	
	LH32DB078	
	LH32DB076	
	LH32DB203	
	LH32DB201	
	LH32DB206	
	LH32DB209	
	LH32DB210	

ACCESSORIES (continued)

DESCRIPTION	ACCESSORY
HUMIDIFIER	Model HUM
HEAT RECOVERY VENTILATOR	Model HRV
ENERGY RECOVERY VENTILATOR	Model ERV
UV LIGHTS	Model UVL

Carrier has a wide variety of thermostats for your system, please visit www.Carrier.com to see all thermostat and IAQ products.

DESCRIPTION	ACCESSORY	14"	17"	21"	24"
Carrier Carbon Monoxide Alarm (10 pack)	COALMCCNRB02-A10	X	X	X	X
Carrier Infinity Air Purifier - 16x25 (407x635 mm)	DGAPAXX1625	X	X		
Carrier Infinity Air Purifier - 20x25 (508x635 mm)	DGAPAXX2025			X	X
Carrier Infinity Air Purifier Repl. Filter- 16x25 (407x635 mm)	GAPCCAR1625-A05	X	X		
Carrier Infinity Air Purifier Repl. Filter- 20x25 (508x635 mm)	GAPCCAR2025-A05			X	X
Cartridge Media Filter - 16" (407 mm) (MERV 11)	FILXXCAR0116	X	X		
Cartridge Media Filter - 16" (407 mm) (MERV 8)	FILXXCAR0016	X	X		
Cartridge Media Filter - 20" (508 mm) (MERV 8)	FILXXCAR0020			X	
Cartridge Media Filter - 20" (508 mm) (MERV11)	FILXXCAR0120			X	
Cartridge Media Filter - 24" (610 mm) (MERV 8)	FILXXCAR0024				X
Cartridge Media Filter - 24" (610 mm) (MERV11)	FILXXCAR0124				X
EZ Flex Cabinet Side or Bottom - 16"	EZX CAB --0016	X	X		
EZ Flex Cabinet Side or Bottom - 20"	EZX CAB --0020			X	X
EZ Flex Replacement Filters 16" MERV 10	EXPXXFIL0016	X	X		
EZ Flex Replacement Filters 16" MERV 13	EXPXXFIL0316	X	X		
EZ Flex Replacement Filters 20" MERV 10	EXPXXFIL0020			X	
EZ Flex Replacement Filters 20" MERV 13	EXPXXFIL0320			X	
EZ Flex Replacement Filters 24" MERV 10	EXPXXFIL0024				X
EZ Flex Replacement Filters 24" MERV 13	EXPXXFIL0324				X
EZ-Flex Filter with End Caps - 16" (407 mm) (MERV 10)	EXPXXUNV0016	X	X		
EZ-Flex Filter with End Caps - 16" (407 mm) (MERV 13)	EXPXXUNV0316	X	X		
EZ-Flex Filter with End Caps - 20" (508 mm) (MERV 10)	EXPXXUNV0020			X	
EZ-Flex Filter with End Caps - 20" (508 mm) (MERV 13)	EXPXXUNV0320			X	
EZ-Flex Filter with End Caps - 24" (610 mm) (MERV 10)	EXPXXUNV0024				X
EZ-Flex Filter with End Caps - 24" (610 mm) (MERV 13)	EXPXXUNV0324				X
Media Filter Cabinet - 20"	FILCABXL0020			X	
Media Filter Cabinet - 24"	FILCABXL0024				X
Media Filter Cabinet - 16"	FILCABXL0016	X	X		

TYPICAL WIRING SCHEMATIC

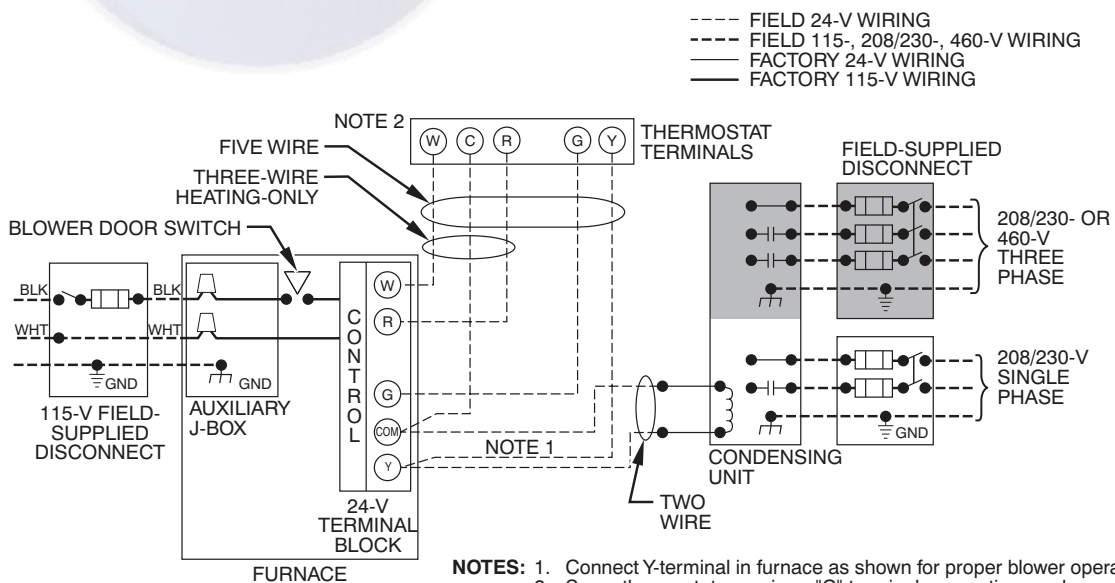

Representative drawing only, some models may vary.

AIR DELIVERY - CFM (With Filter)

Furnace	Wire Lead Color	Function	Test Airflow Delivery @ Various External Static Pressures									
			0.1	0.2	0.3	0.4	0.5	0.6	0.7	0.8	0.9	1
045E14-12	Gray	Cooling. Do not use for heating.	1230	1190	1155	1120	1080	1045	1010	975	935	895
	Yellow	Alt Cooling or alt Heating	980	945	920	890	855	815	770	735	690	645
	Orange	Alt Cooling or alt Heating	770	720	685	640	600	560	520	475	430	385
	Blue	Heating or alt Cooling	710	660	620	580	540	490	455	415	375	335
	Red	Alt Cooling. Do not use for heating.	600	540	500	455	415	385	345	305	235	-
045E17-12	Gray	Cooling. Do not use for heating.	1370	1335	1295	1255	1215	1175	1135	1095	1055	1020
	Yellow	Alt Cooling or alt Heating	1130	1085	1040	995	955	910	865	825	780	730
	Orange	Alt Cooling or alt Heating	930	885	835	795	745	700	655	600	545	495
	Blue	Heating or alt Cooling	760	720	670	625	580	515	460	410	355	300
	Red	Alt Cooling. Do not use for heating.	610	500	445	375	320	260	200	135	-	-
070E14-12	Gray	Cooling. Do not use for heating.	1205	1170	1143	1105	1070	1035	1000	960	925	885
	Blue	Heating or alt Cooling	1095	1060	1030	995	960	925	885	840	800	735
	Yellow	Alt Cooling or alt Heating	920	880	845	805	765	730	685	620	560	510
	Orange	Alt Cooling. Do not use for heating.	715	650	610	575	520	465	410	380	305	245
	Red	Alt Cooling. Do not use for heating.	635	490	445	375	315	270	205	230	190	140
070E17-12	Gray	Cooling. Do not use for heating.	1185	1140	1095	1055	1005	960	915	865	820	780
	Yellow	Alt Cooling or alt Heating	1000	940	895	850	800	750	695	650	600	555
	Blue	Heating or alt Cooling	990	935	895	845	790	740	690	640	590	535
	Orange	Alt Cooling or alt Heating	855	775	720	660	605	560	495	435	385	335
	Red	Alt Cooling. Do not use for heating.	860	685	515	445	385	340	275	205	-	-
070E21-16	Gray	Cooling. Do not use for heating.	1735	1685	1640	1595	1545	1495	1450	1405	1360	1310
	Yellow	Alt Cooling or alt Heating	1480	1435	1395	1340	1290	1240	1190	1135	1085	1030
	Blue	Heating or alt Cooling	1315	1275	1225	1180	1135	1085	1030	975	915	860
	Orange	Alt Cooling or alt Heating	1135	1080	1030	985	935	885	835	770	705	645
	Red	Alt Cooling. Do not use for heating.	980	930	875	820	775	715	665	595	530	455
090E17-14	Gray	Cooling. Do not use for heating.	1355	1320	1285	1245	1210	1165	1125	1080	1025	815
	Yellow	Alt Cooling or alt Heating	1295	1255	1220	1185	1140	1100	1055	1005	955	815
	Blue	Heating or alt Cooling	1220	1185	1150	1105	1065	1025	975	915	840	740
	Orange	Alt Cooling or alt Heating	1030	985	940	900	845	790	715	655	590	535
	Red	Alt Cooling. Do not use for heating.	945	905	855	800	750	670	600	540	490	435
090E21-16	Gray	Cooling. Do not use for heating.	1625	1580	1535	1490	1445	1395	1340	1260	1135	995
	Yellow	Alt Cooling or alt Heating	1425	1380	1335	1290	1235	1185	1125	1075	1020	640
	Blue	Heating or alt Cooling	1440	1395	1350	1305	1255	1200	1145	1090	1040	950
	Orange	Alt Cooling or alt Heating	1260	1210	1160	1105	1050	990	935	880	820	755
	Red	Alt Cooling. Do not use for heating.	1095	1040	980	905	845	780	720	650	585	520
090E21-20	Gray	Cooling. Do not use for heating.	2180	2130	2080	2030	1980	1925	1870	1805	1745	1680
	Yellow	Alt Cooling or alt Heating	1900	1845	1795	1740	1685	1635	1570	1500	1435	1375
	Blue	Heating or alt Cooling	1685	1620	1565	1505	1455	1385	1320	1260	1200	1140
	Orange	Alt Cooling or alt Heating	1390	1315	1240	1175	1095	1030	970	900	825	760
	Red	Alt Cooling. Do not use for heating.	1240	1155	1075	990	915	835	765	690	615	555
090E24-20	Gray	Cooling. Do not use for heating.	2190	2135	2075	2015	1960	1900	1835	1775	1705	1630
	Yellow	Alt Cooling or alt Heating	1870	1810	1745	1685	1625	1565	1495	1420	1345	1280
	Blue	Heating or alt Cooling	1580	1510	1445	1385	1320	1240	1175	1115	1050	970
	Orange	Alt Cooling or alt Heating	1305	1220	1160	1075	1000	930	865	770	690	610
	Red	Alt Cooling. Do not use for heating.	1210	1075	1000	915	845	765	675	595	515	425
110E21-20	Gray	Cooling. Do not use for heating.	2255	2205	2150	2100	2040	1985	1920	1835	1735	1615
	Blue	Heating or alt Cooling	1945	1890	1830	1770	1715	1655	1600	1545	1480	1430
	Yellow	Alt Cooling or alt Heating	1600	1525	1465	1400	1335	1275	1210	1150	1080	1015
	Orange	Alt Cooling. Do not use for heating.	1420	1340	1280	1200	1140	1065	1005	925	865	790
	Red	Alt Cooling. Do not use for heating.	1280	1205	1140	1055	990	910	840	760	695	630
110E24-20	Gray	Cooling. Do not use for heating.	2250	2190	2130	2070	2005	1950	1885	1820	1755	1685
	Blue	Heating or alt Cooling	1995	1930	1865	1800	1740	1670	1605	1535	1465	1400
	Yellow	Alt Cooling. Do not use for heating.	1540	1460	1385	1305	1235	1165	1095	1035	955	890
	Orange	Alt Cooling or alt Heating	1345	1195	1135	1055	980	920	845	770	695	620
	Red	Alt Cooling. Do not use for heating.	1335	1075	965	890	820	735	660	580	505	440
135E24-20	Gray	Cooling. Do not use for heating.	2065	2005	1940	1875	1810	1740	1670	1600	1530	1470
	Blue	Heating or alt Cooling	1825	1760	1695	1630	1560	1490	1420	1350	1275	1205
	Yellow	Alt Cooling or alt Heating	1760	1690	1625	1555	1485	1415	1345	1275	1200	1130
	Orange	Alt Cooling. Do not use for heating.	1620	1550	1480	1405	1335	1260	1195	1130	1065	995
	Red	Alt Cooling. Do not use for heating.	1325	1260	1185	1100	1025	955	885	805	735	670
155E24-20	Gray	Cooling. Do not use for heating.	2205	2150	2090	2030	1965	1905	1840	1780	1710	1645
	Blue	Heating or alt Cooling	2055	1995	1935	1875	1810	1750	1690	1615	1540	1460
	Yellow	Alt Cooling or alt Heating	1860	1795	1730	1670	1605	1540	1470	1395	1320	1250
	Orange	Alt Cooling. Do not use for heating.	1495	1430	1355	1285	1210	1130	1065	995	930	850
	Red	Alt Cooling. Do not use for heating.	1295	1085	1000	910	835	765	670	600	530	465

1. A filter is required for each return-air inlet. Airflow performance included 3/4-in. (19 mm) washable filter media such as contained in factory-authorized accessory filter rack. To determine airflow performance without this filter, assume an additional 0.1 In. W.C. available external static pressure.

2. Adjust the blower speed tabs as necessary for the proper air temperature rise for each installation.

3. -- Indicates unstable operating conditions.

4. If the same motor speed tap is needed for heating and cooling, a Jumper Wire accessory kit is available (see Product Data sheet for the current Jumper Wire accessory part number), see Function column for applicable limitations.

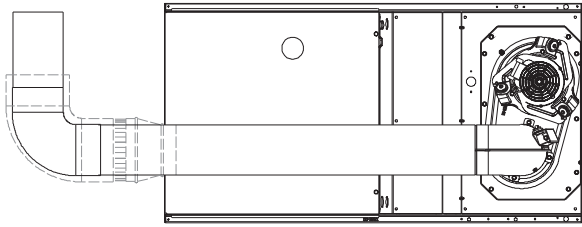

SEE NOTES 1,2,4,5,7,8,9
HORIZONTAL RIGHT

A02068

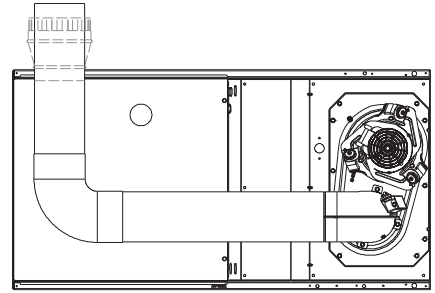

SEE NOTES 1,2,4,5,7,8,9
HORIZONTAL RIGHT

A02070

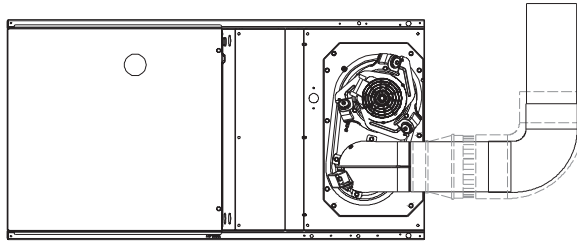

SEE NOTES 1,2,4,7,8,9
HORIZONTAL RIGHT

A02069

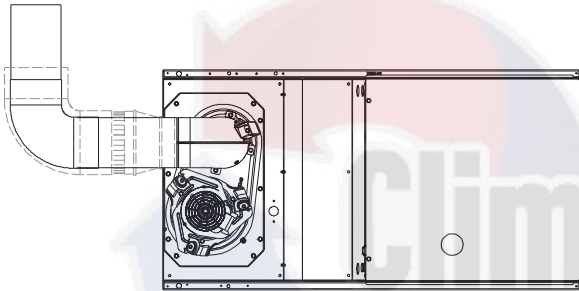

SEE NOTES 1,2,4,7,8,9
HORIZONTAL LEFT

A02064

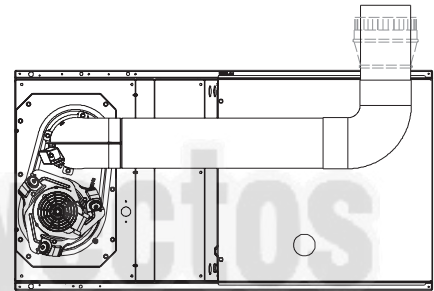

SEE NOTES 1,2,4,5,7,8,9
HORIZONTAL LEFT

A02065

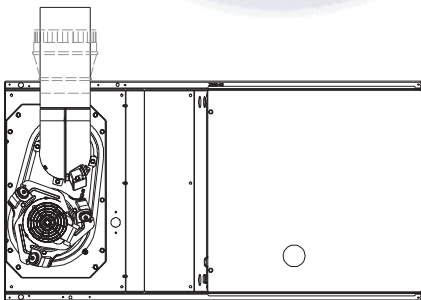

SEE NOTES 1,2,4,5,7,8,9
HORIZONTAL LEFT

A02066

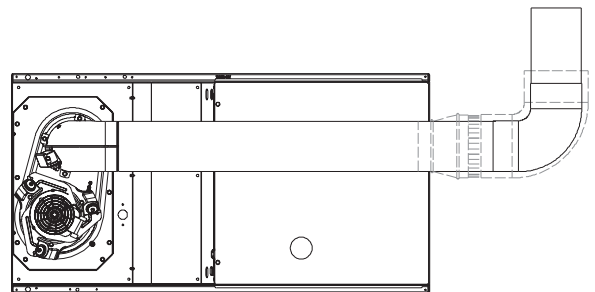

SEE NOTES 1,2,4,5,7,8,9
HORIZONTAL LEFT

A02067

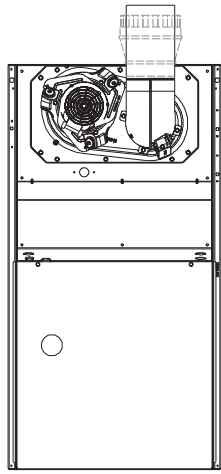

SEE NOTES: 1,2,4,7,8,9
UPFLOW

A02058

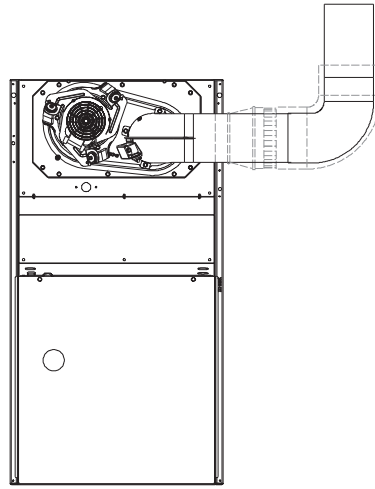

SEE NOTES: 1,2,3,4,7,8,9
UPFLOW

A02059

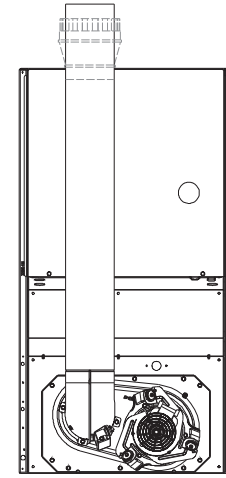

SEE NOTES: 1,2,4,5,7,8,9
DOWNFLOW

A02061

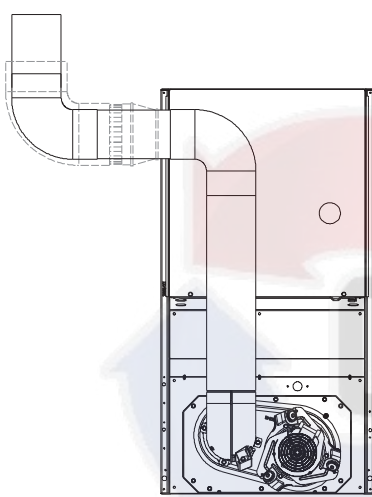

SEE NOTES: 1,2,3,4,5,7,8,9
DOWNFLOW

A02060

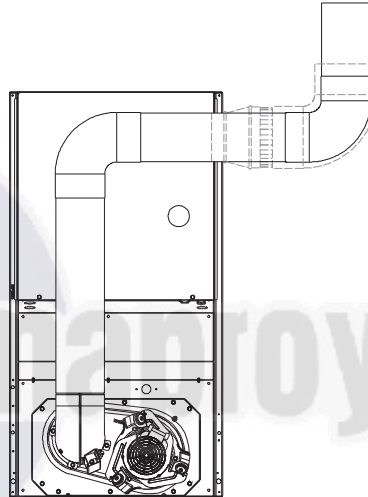

SEE NOTES: 1,2,3,4,5,7,8,9
DOWNFLOW

A02063

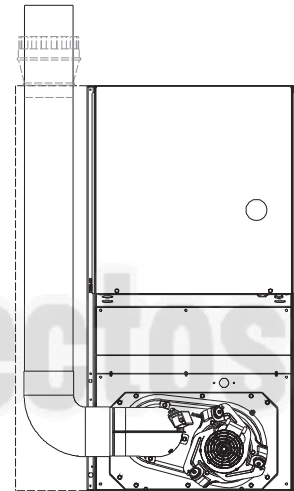

SEE NOTES: 1,2,4,5,6,7,8,9
DOWNFLOW

A02062

Venting Notes

1. For common vent, vent connector sizing and vent material: United States, latest edition of the National Fuel Gas Code (NFGC), ANSI Z223.1/NFPA 54.
2. Immediately increase to 5-in. (127 mm) vent connector outside furnace casing when 5-in. (127 mm) vent connector required, refer to Note 1.
3. Side outlet vent for upflow and downflow installations must use Type B vent immediately after exiting the furnace, except when Downflow Vent Guard is used in downflow position.
4. Type B vent where required, refer to Note 1.
5. 4-in. (102 mm) single wall vent must be used inside furnace casing and the Downflow Vent Guard Kit.
6. Accessory Downflow Vent Guard Kit required in downflow installations with bottom vent configuration.
7. Chimney Adapter Kit required for exterior masonry chimney applications. Refer to Chimney Adapter Kits for sizing and complete application details.
8. Secure vent connector to furnace elbow with (2) corrosion-resistant sheet metal screws, space approximately 180° apart.
9. Secure all other single wall vent connector joints with (3) corrosion-resistant screws spaced approximately 120° apart. Secure Type B vent connectors per vent connector manufacturer's recommendations.

DIMENSIONS

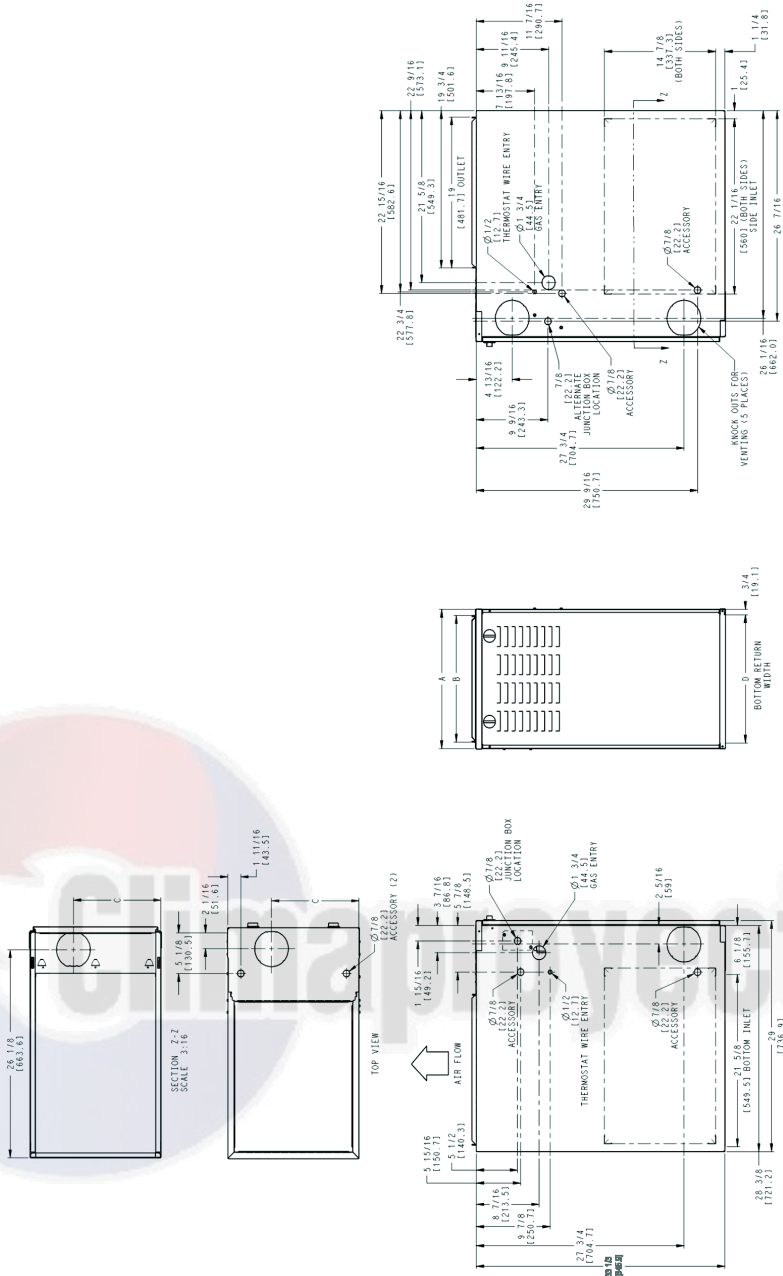

A190084

FURNACE SIZE	A CABINET WIDTH	B OUTLET WIDTH	C TOP AND BOTTOM FLUE COLLAR	D BOTTOM INLET WIDTH	VENT CONNECTION SIZE	SHIP WT. LB. (KG)
045E14-12	14-3/16 (360)	12-9/16 (319)	9-5/16 (237)	12-11/16 (322)	4 (102)	104 (47)
045E17-12	17-1/2 (445)	15-7/8 (403)	11-9/16 (294)	16 (406)	4 (102)	119 (54)
070E14-12	14-3/16 (360)	12-9/16 (319)	9-5/16 (237)	12-11/16 (322)	4 (102)	114 (52)
070E17-12	17-1/2 (445)	15-7/8 (403)	11-9/16 (294)	16 (406)	4 (102)	120 (54)
070E21-16	21 (533)	19-3/8 (492)	13-5/16 (338)	19-1/2 (495)	4 (102)	142 (64)
090E17-14	17-1/2 (445)	15-7/8 (403)	11-9/16 (294)	16 (406)	4 (102)	131 (49)
090E21-16	21 (533)	19-3/8 (492)	13-5/16 (338)	19-1/2 (495)	4 (102)	137 (62)
090E21-20	21 (533)	19-3/8 (492)	13-5/16 (338)	19-1/2 (495)	4 (102)	140 (64)
090E24-20	24-1/2 (622)	22-7/8 (581)	15-1/16 (383)	23 (584)	4 (102)	146 (66)
110E21-20	21 (533)	19-3/8 (492)	13-5/16 (338)	19-1/2 (495)	4 (102)	146 (66)
110E24-20	24-1/2 (622)	22-7/8 (581)	15-1/16 (383)	23 (584)	4 (102)	161 (73)
135E24-20	24-1/2 (622)	22-7/8 (581)	15-1/16 (383)	23 (584)	4 (102)	167 (76)
155E24-20	24-1/2 (622)	22-7/8 (581)	15-1/16 (383)	23 (584)	4 (102)	168 (76)

*135 and 155 size furnaces require a 5 or 6-in. (127 or 152 mm) vent. Use a vent adapter between furnace and vent stack. See Installation Instructions for complete installation requirements.

GUIDE SPECIFICATIONS

Gas Furnace

58SB0A/58SB1A

General

SYSTEM DESCRIPTION

Furnish a _____ fixed capacity gas-fired furnace for use with natural gas or propane (factory authorized conversion kit required for propane); furnish cold air return plenum.

QUALITY ASSURANCE

Unit will be designed, tested and constructed to the current ANSI Z 21.47/CSA 2.3 design standard for gas-fired central furnaces.

Unit will be 3rd party certified by CSA to the current ANSI Z 21.47/CSA 2.3 design standard for gas-fired central furnaces.

Unit will carry the CSA Blue Star® label.

Unit efficiency testing will be performed per the current DOE test procedure as listed in the Federal Register.

Unit will be certified for capacity and efficiency and listed in the latest AHRI Consumer's Directory of Certified Efficiency Ratings.

Unit shall carry the current Federal Trade Commission Energy Guide efficiency label.

DELIVERY, STORAGE AND HANDLING

Unit shall be shipped as single package only and is stored and handled per unit manufacturer's recommendations.

WARRANTY (for inclusion by specifying engineer)

Warranty certificate available upon request.

EQUIPMENT

Components shall include: slow-opening gas valve to reduce ignition noise, regulate gas flow, with electric switch gas shut-off; flame proving sensor, hot surface igniter, pressure switch assembly, flame rollout switch, blower and inducer assembly, 40va transformer; low-voltage (heating) (heating/cooling) thermostat.

Blower Wheel and Blower Motor

Galvanized blower wheel shall be centrifugal type, statically and dynamically balanced. Blower motor of fixed-speeds, constant torque ECM type shall be permanently lubricated with sealed bearings, of _____ hp, and shall be multiple-speed direct drive. Blower motor shall be soft mounted to the blower scroll to reduce vibration transmission.

Filters

Furnace may have reusable-type filters. Filter shall be _____ in. (mm) (x) _____ in. (mm). An accessory high efficiency Media Filter is available as an option. _____ Media Filter.

Casing

Casing shall be of .030 in. (.76) thickness minimum, pre-painted steel.

Inducer Motor

Inducer motor shall be soft mounted to reduce vibration transmission.

Draft Safeguard Switch

Draft Safeguard Switch (blocked vent safeguard) shall be factory installed to reduce the possibility of vent gas infiltration due to a blocked or restricted vent pipe.

Heat Exchangers

Heat exchangers shall be a 4-Pass 20 gage aluminized steel of fold-and-crimp sectional design when applied operating under negative pressure.

Controls

Control shall include a micro-processor based integrated electronic control board with at least 11 service troubleshooting codes displayed via enhanced flashing LED diagnostic light on the control, a self-test feature that checks all major functions of the furnace within one minute, and a non-volatile memory replaceable automotive-type circuit protection fuse. Multiple operational settings available including, separate blower speeds for heating, cooling and continuous fan. Cooling airflow will be selectable between 350 or 400 CFM per ton of air conditioning.

OPERATING CHARACTERISTICS

Heating Capacity shall be _____ Btuh input; _____ Btuh output capacity.

Fuel Gas Efficiency shall be 80% AFUE. Air delivery shall be _____ CFM minimum at 0.50 In. W.C. external static pressure.

Dimensions shall be: depth _____ in. (mm); width _____ in. (mm); height _____ in. (mm) (casing only). Height shall be _____ in. (mm) with A/C coil and _____ in. (mm) overall with plenum.

ELECTRICAL REQUIREMENTS

Electrical supply shall be 115 volts, 60 Hz, single-phase (nominal). Minimum wire size shall be _____ AWG; maximum fuse size or circuit breaker shall be _____ Amps.

SPECIAL FEATURES

Refer to section of the product data sheet identifying accessories and descriptions for specific features and available enhancements.

