

Dimensions

Body dimension

Unit: in.(mm)

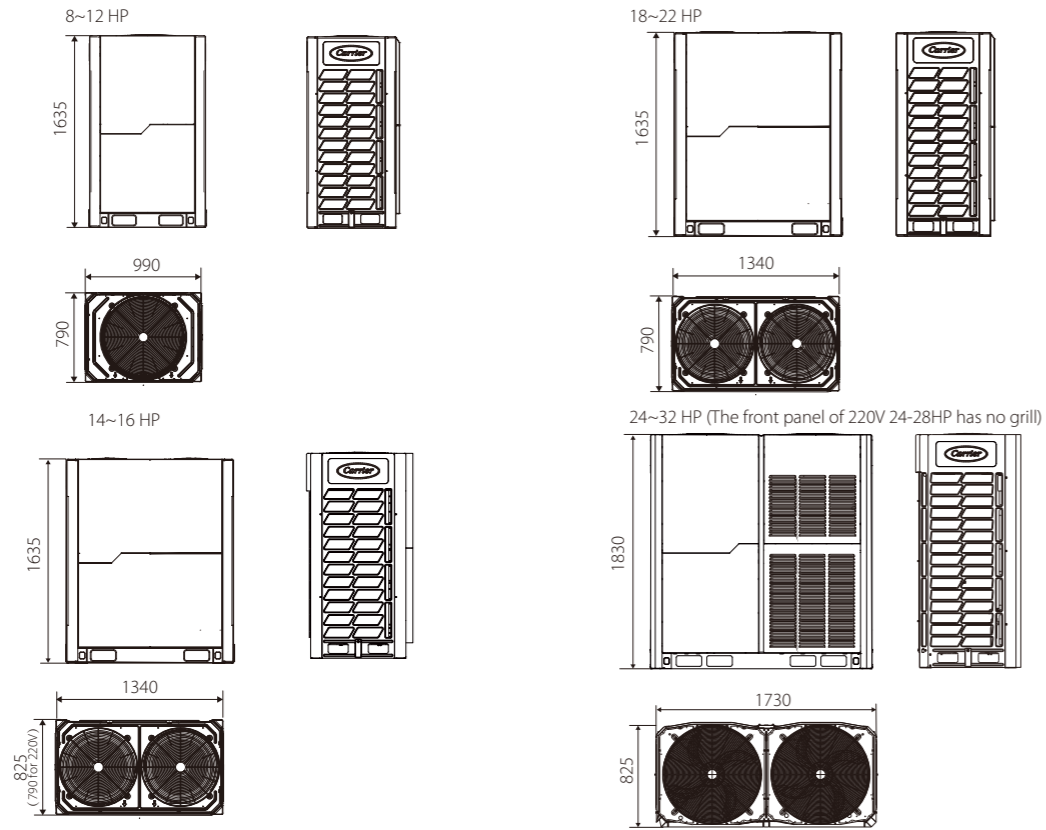

Installation dimension

Unit: in.(mm)

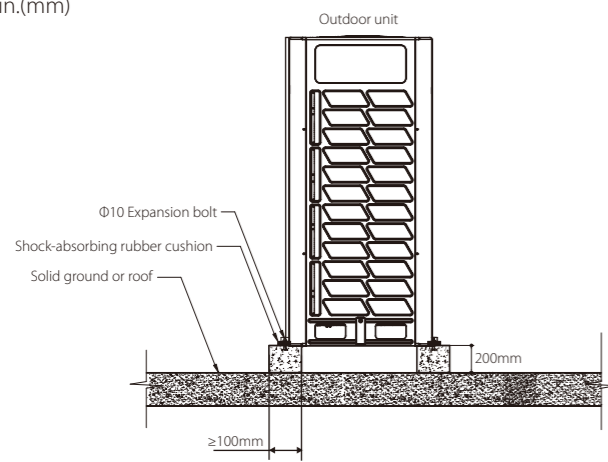

Expansion bolt positioning (Unit: mm)

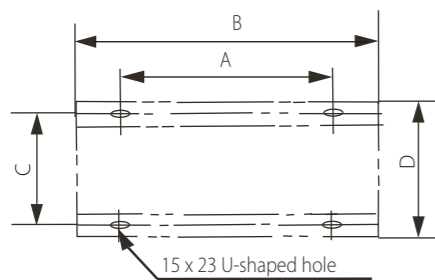

HP	8,10, 12	14,16,18, 20, 22	24,26,28,30,32
SIZE			
A	740	1090	1480
B	990	1340	1730
C	723	723	723
D	790	790	790

Super XC Series Cooling Only VRF



Energy saving

Energy Management System (EMS)

- Floating refrigerant temperature to balance comfort and efficiency
The evaporating temperature is automatically adjusted according to both indoor and outdoor temperature to maximize the comfort and energy efficiency.
- Output limitation during electricity supply restrictions
With the integration of EMS, for projects with temporary electricity supply restrictions, CO VRF can be set to output 40-100% capacity.

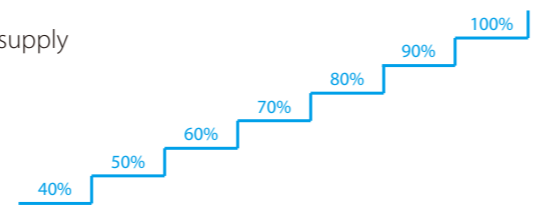
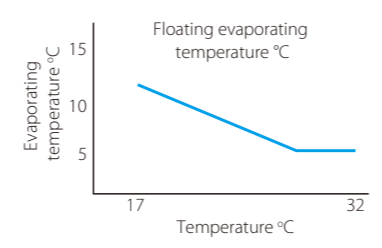

4-side heat exchanger

G-type heat exchangers have higher energy efficiency than the U-type.

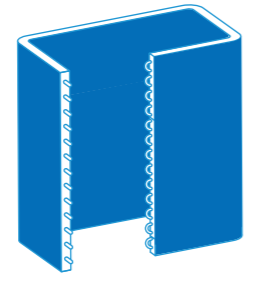

2-rows G-type heat exchanger

High efficiency "2-1" refrigerant flow

The high efficiency "2-1" refrigerant flow increases the proportion of liquid refrigerant in heat exchanger and improve heat exchange efficiency.

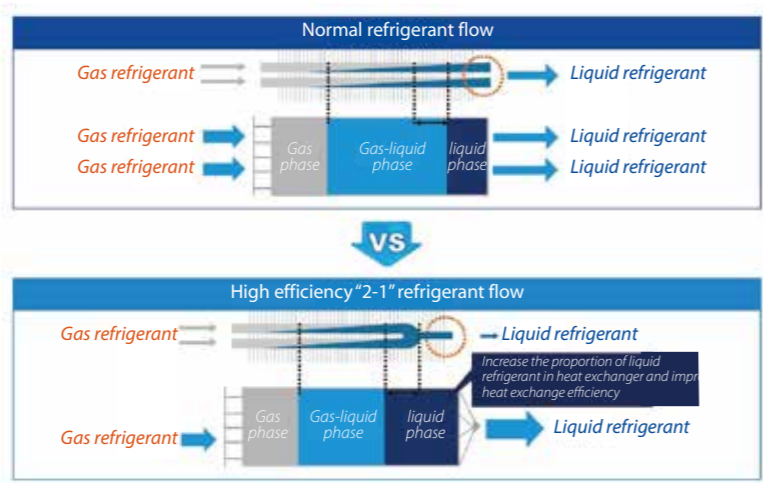

Wide Application Range

Wide Capacity Range

For single unit, the footprint is small and maximum capacity is up to 30HP. For combined units, maximum three 30HP units can be combined with capacity up to 90HP.



Wide Operation Rang

The CO VRF can operate stably in a wide ambient temperature range: from -5°C to 55°C in cooling mode.

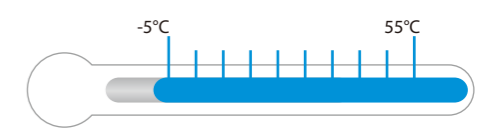

Long Piping Capability

- Total piping length: 1000m
- Longest piping length-actual (equivalent): 175m(200m)
- Longest piping length after first branch: 40/90*m
- Level difference between IDUs and ODU-ODU above (below): 90m (110m)
- Level difference between IDUs: 30m

*The longest length after 1st branch is 40m as standard but can be extended up to 90m under certain conditons. Please contact your local Carrier dealer for further information

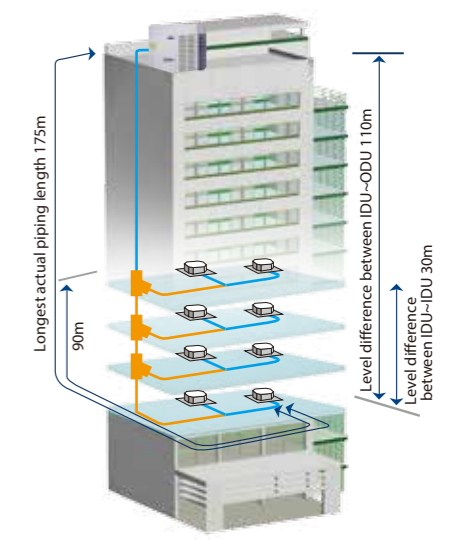

Selectable ESP of outdoor unit*

Selectable external static pressure of outdoor unit: 0Pa, 20Pa, 40Pa, 60 Pa which can meet most of installation requirements.

*This function is available as a customization option.



High Reliability

Real-time Refrigerant Amount Monitoring

The temperature and pressure of refrigerant can be real-time monitored by the outdoor unit. When the level of refrigerant is too low or too high, it can cause damage to the unit and poor performance. CO outdoor unit can detect excessive or insufficient amounts of refrigerant to ensure consistent performance.

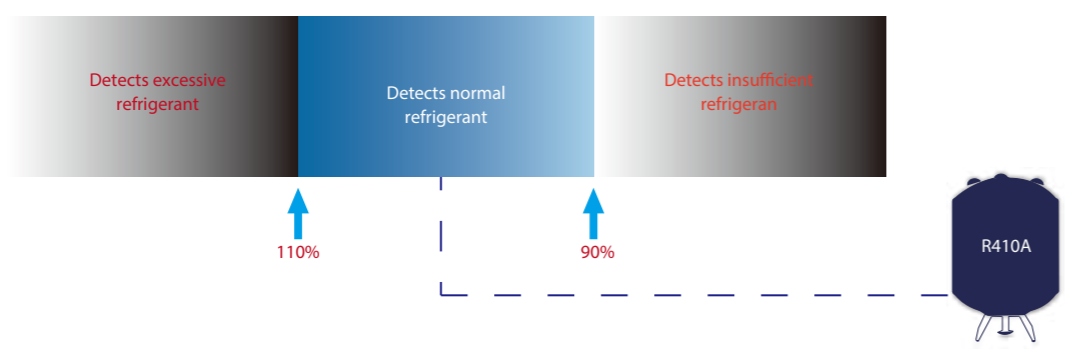

Duty Cycling

Duty cycling equalizes the running time of the outdoor units in a multiple-unit system and of the compressors in each unit, significantly extending compressor lifespan.



In units with two compressors, if one compressor fails, the other compressor can run on its own for up to 4 days, allowing time for maintenance or repair whilst maintaining comfort.

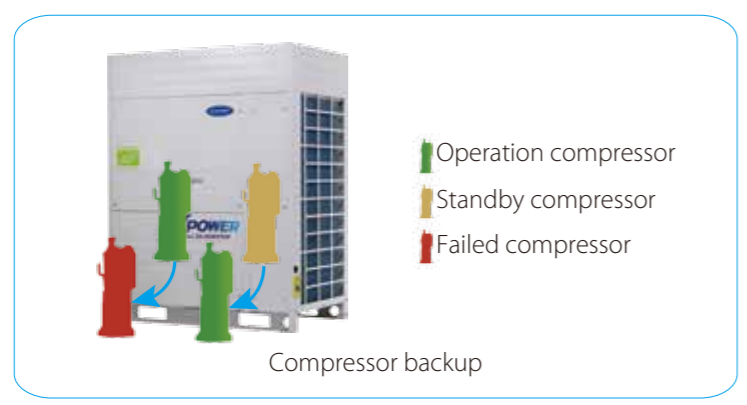

High Reliability

Refrigerant cooling PCB

The CO VRF uses refrigerant cooling technology to cool the electric control box. It decreases the average temperature of electrical control components by about 8 degrees, guaranteeing the stable and safe running of the control system.

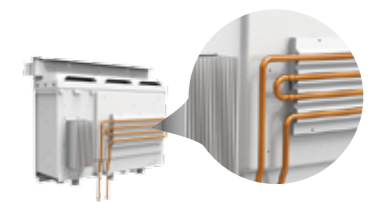

Intelligent Configurations

Intelligent configurations greatly simplify installation, commissioning and servicing.

- Field local configuration achieves quick and easy on-site settings, simplifies installation and commissioning.
- System checking and settings also can be easily achieved via wired controller making the configuration more flexible and convenient.
- A desktop or laptop PC can be used for browser-based access to achieve system configurations through IMMPRO gateway via a LAN connection.



Automatic Refrigerant Charging

Automatic refrigerant charging makes installation and service easier and more efficient.

**This function is available as a customization option.*



Dust-clean function*

The innovatively designed dust-clean function enables the outdoor unit to prevent the dust by itself.

**This function is available as a customization option.*



Enhanced Comfort

Optional silent modes

CO VRF has optional silent modes including night silent mode and non-night silent mode which provides more freedom and convenience to match the customers' needs. Different silent mode is achieved by setting up field settings or through the centralized controller.

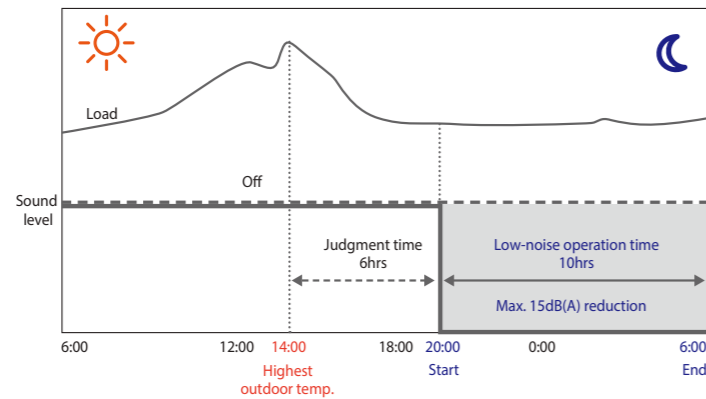

Silent technology features

Several noise reducing components reduce the running noise of outdoor units.



Precise temperature control

CO outdoor unit uses multiple and high precision EXVs to create comfortable indoor environment. The EXV control precision is up to 3000-stage which can precisely control refrigerant flow and guarantee stable indoor temperature. In this way, temperature setting can be adjusted in 0.5°C step, enabling precise comfort control.



Specifications (Super XC 220V)



HP			8	10	12	14	16	18	
Model name			38VF008C11B016	38VF010C11B016	38VF012C11B016	38VF014C11B016	38VF016C11B016	38VF018C11B016	
Power supply	V/Ph/Hz		220-240V 3Ph 50Hz&208-230V 3Ph 60Hz						
Cooling ¹	Capacity	kW	22.4	28.0	33.5	40.0	45.0	50.0	
		kBtu/h	76.5	95.6	114.4	136.6	153.7	170.8	
	Power input	kW	5.25	7.10	8.90	10.30	12.00	13.70	
	EER		4.27	3.94	3.76	3.88	3.75	3.65	
Connected indoor unit	Total capacity	50-130%							
	Maximum quantity		13	16	20	23	26	29	
Compressor	Type	DC inverter							
	Quantity		1			1		2	
	Oil type	FV 50s							
	Start-up method	Soft start							
Fan	Type	DC							
	Quantity		1			1		2	
	Motor output	kW	0.56			0.75		0.56x2	
	Static pressure	Pa(in.wg)	20(0.08) default;60(0.24) customization option						
	Airflow rate	m ³ /h(CFM)	10400(6121)		10800(6357)		11600(6828)		12000(7063)
Refrigerant	Type	Direct R410A							
	Factory charge	kg(lbs)	8(17.6)		11(24.3)		13(28.7)		
Pipe connections ²	Liquid pipe	mm(inch)	Φ12.7(1/2)		Φ12.7(1/2)		Φ15.9(5/8)		
	Gas pipe	mm(inch)	Φ25.4(1)		Φ28.6(1-1/8)		Φ31.8(1-1/4)		
Sound pressure level ³		dB(A)	57	58	60	60	61	62	
Net dimensions (WxHxD)		mm	960x1615x765			960x1615x765		1250x1615x765	
		inch	37-13/16x63-9/16x30-1/8			37-13/16x63-9/16x30-1/8		49-1/4x63-9/16x30-1/8	
Packed dimensions (WxHxD)		mm	1025x1790x830			1025x1790x830		1305x1790x820	
		inch	40-3/8x70-1/2x32-11/16			40-3/8x70-1/2x32-11/16		51-3/8x70-1/2x32-11/16	
Net weight		kg	193			200		296	
		lbs	425			441		653	
Gross weight		kg	209			216		313	
		lbs	461			476		690	
Ambient temp.	Cooling	°C(°F)	-5(23) to 55(131)						



HP			20	22	24	26	28	30
Model name			38VF020C11B016	38VF022C11B016	38VF024C11B016	38VF026C11B016	38VF028C11B016	38VF030C11B016
Power supply	V/Ph/Hz		220-240V 3Ph 50Hz&208-230V 3Ph 60Hz					
Cooling ¹	Capacity	kW	56.0	61.5	67.0	73.0	78.5	85.0
		kBtu/h	191.3	210.0	228.8	249.3	268.1	290.3
	Power input	kW	16.50	19.65	20.10	22.20	24.18	27.51
	EER		3.39	3.13	3.33	3.29	3.25	3.09
Connected indoor unit	Total capacity	50-130%						
	Maximum quantity		33	36	39	43	46	50
Compressor	Type	DC inverter						
	Quantity		2			2		2
	Oil type	FV 50s						
	Start-up method	Soft start						
Fan	Type	DC						
	Quantity		2			2		2
	Motor output	kW	0.56x2			0.56x2		0.56x2
	Static pressure	Pa(in.wg)	20(0.08) default;60(0.24) customization option					
	Airflow rate	m ³ /h(CFM)	12200(7181)	12200(7181)	19600(11536)		20600(12125)	
Refrigerant	Type	Direct R410A						
	Factory charge	kg(lbs)	13(28.7)	13(28.7)	19(41.9)		19(41.9)	
Pipe connections ²	Liquid pipe	mm(inch)	Φ15.9(5/8)		Φ19.1(3/4)		Φ19.1(3/4)	
	Gas pipe	mm(inch)	Φ31.8(1-1/4)		Φ31.8(1-1/4)		Φ34.9(1-3/8)	
Sound pressure level ³		dB(A)	63	63	64		64	
Net dimensions (WxHxD)		mm	1250x1615x765	1250x1615x765	1585x1615x765		1585x1615x765	
		inch	49-1/4x63-9/16x30-1/8	49-1/4x63-9/16x30-1/8	62-3/8x63-9/16x30-1/8		62-3/8x63-9/16x30-1/8	
Packed dimensions (WxHxD)		mm	1305x1790x820	1305x1790x820	1650x1810x840		1650x1810x840	
		inch	51-3/8x70-1/2x32-1/4	51-3/8x70-1/2x32-1/4	64-15/160x71-1/4x33-1/16		64-15/160x71-1/4x33-1/16	
Net weight		kg	296	296	352		352	
		lbs	653	653	776		776	
Gross weight		kg	313	313	376		376	
		lbs	690	690	829		829	
Ambient temp.	Cooling	°C(°F)	-5(23) to 55(131)					

Notes:

1. Indoor temperature 27°C DB, 19°C WB; outdoor temperature 35°C DB; equivalent refrigerant piping length 7.5m with zero level difference.
 2. Diameters given are those of the unit's accessories.
 3. Sound pressure level is measured at a position 1m in front of the unit and 1.3m above the floor in a semi-anechoic chamber.
- Product specifications change from time to time as product improvements and developments are released and may vary from those in this document.

Specification (Super XC 380V)



HP	8		10		12	
Model name	38VF008C119016		38VF010C119016		38VF012C119016	
Power supply	V/Ph/Hz		380-415V 3N~ 50/60Hz			
Cooling ¹	Capacity (T1/T3)	kW	22.4/20.56	28.0/25.53	33.5/30.21	
		kBtu/h	76.5/70.2	95.6/87.1	114.4/103.1	
	Power input (T1/T3)	kW	5.17/5.71	6.81/7.48	9.13/9.91	
	EER (T1/T3)		4.33/3.60	4.11/3.41	3.67/3.05	
Connected indoor unit	Total capacity		50-130%			
	Maximum quantity		13	16	20	
Compressor	Type		DC inverter			
	Quantity		1			
Fan	Type		DC			
	Model		ZKSN-560-8-42L			
	Quantity		1			
	Motor output	kW	0.56			
	Max. ESP	Pa	20 default;60 customization option			
	Airflow rate	m ³ /h	10400		10800	
Refrigerant	Type		R410A			
	Factory charge	kg	8			
Pipe connections ²	Liquid pipe	mm	Φ12.7	Φ12.7	Φ15.9	
	Gas pipe	mm	Φ25.4	Φ25.4	Φ28.6	
Sound pressure level ³		dB(A)	57	58	60	
Net dimensions (WxHxD)		mm	960x1615x765			
Packed dimensions (WxHxD)		mm	1025x1790x830			
Net weight		kg	188			
Gross weight		kg	204			
Ambient temp.	Cooling	°C	-5 °C to 55 °C			



HP	14		16		18		20	
Model name	38VF014C119016		38VF016C119016		38VF018C119016		38VF020C119016	
Power supply	V/Ph/Hz		380-415V 3N~ 50/60Hz					
Cooling ¹	Capacity (T1/T3)	kW	40/36.71	45/40.58	50/45.89	56/51.06		
		kBtu/h	136.6/125.3	153.7/138.5	170.8/156.6	191.3/174.3		
	Power input (T1/T3)	kW	10.58/11.69	12.26/13.30	14.88/16.44	17.66/19.39		
	EER (T1/T3)		3.78/3.14	3.67/3.05	3.36/2.79	3.17/2.63		
Connected indoor unit	Total capacity		50-130%					
	Maximum quantity		23	26	29	33		
Compressor	Type		DC inverter					
	Quantity		1		2			
Fan	Type		DC					
	Model		ZKSN-750-8-2		ZKSN-560-8-42L			
	Quantity		1		2			
	Motor output	kW	0.75		0.56x2			
	Max. ESP	Pa	20 default;60 customization option					
	Airflow rate	m ³ /h	11600		12000		12200	
Refrigerant	Type		R410A		R410A			
	Factory charge	kg	11		13			
Pipe connections ²	Liquid pipe	mm	Φ15.9		Φ19.1		Φ22.2	
	Gas pipe	mm	Φ31.8		Φ31.8		Φ31.8	
Sound pressure level ³		dB(A)	60		63			
Net dimensions (WxHxD)		mm	960x1615x765		1250x1615x765			
Packed dimensions (WxHxD)		mm	1025x1790x830		1305x1790x820			
Net weight		kg	197		278			
Gross weight		kg	213		297			
Ambient temp.	Cooling	°C	-5 °C to 55 °C					

Notes:

- T1 Cooling: Indoor temperature 27°CDB/19°C WB; Outdoor temperature 35°C DB/24°C WB;
T3 Cooling: Indoor temperature 29°C DB/19°C WB; Outdoor temperature 46°C DB/24°C WB;
Piping length: Interconnecting piping length is 7.5m, level difference is zero.
- Diameters given are those of the unit's accessories.
- Sound pressure level is measured at a position 1m in front of the unit and 1.3m above the floor in a semi-anechoic chamber.

Specification (Super XC 380V)



HP	22		24		26	
Model name	38VF022C119016		38VF024C119016		38VF026C119016	
Power supply	V/Ph/Hz		380-415V 3N~ 50/60Hz			
Cooling ¹	Capacity (T1/T3)	kW	61.5/55.46	67/61.49	73/66.56	
		kBtu/h	210.0/189.3	228.8/209.9	249.3/227.2	
	Power input (T1/T3)	kW	20.23/21.96	20.68/22.85	23.4/25.69	
	EER (T1/T3)		3.04/2.53	3.24/2.69	3.12/2.59	
Connected indoor unit	Total capacity		50-130%		50-130%	
	Maximum quantity		36	39	43	
Compressor	Type		DC inverter			
	Quantity		2			
Fan	Type		DC			
	Model		ZKSN-560-8-42L			
	Quantity		2			
	Motor output	kW	0.56x2			
	Max. ESP	Pa	20 default;60 customization option			
	Airflow rate	m ³ /h	12200		19600	
Refrigerant	Type		R410A			
	Factory charge	kg	13		19	
Pipe connections ²	Liquid pipe	mm	Φ19.1		Φ22.2	
	Gas pipe	mm	Φ31.8		Φ31.8	
Sound pressure level ³		dB(A)	63		64	
Net dimensions (WxHxD)		mm	1250x1615x765		1585x1615x765	
Packed dimensions (WxHxD)		mm	1305x1790x820		1650x1810x840	
Net weight		kg	278		338	
Gross weight		kg	297		362	
Ambient temp.	Cooling	°C	-5 °C to 55 °C			



HP	28		30	
Model name	38VF028C119016		38VF030C119016	
Power supply	V/Ph/Hz		380-415V 3N~ 50/60Hz	
Cooling ¹	Capacity (T1/T3)	kW	78.5/70.79	85/76.65
		kBtu/h	268.1/241.6	290.3/261.6
	Power input (T1/T3)	kW	26.08/28.3	29.51/32.02
	EER (T1/T3)		3.01/2.50	2.88/2.39
Connected indoor unit	Total capacity		50-130%	
	Maximum quantity		46	
Compressor	Type		DC inverter	
	Quantity		2	
Fan	Type		DC	
	Model		ZKSN-560-8-42L	
	Quantity		2	
	Motor output	kW	0.56x2	
	Max. ESP	Pa	20 default;60 customization option	
	Airflow rate	m ³ /h	20600	
Refrigerant	Type		R410A	
	Factory charge	kg	19	
Pipe connections ²	Liquid pipe	mm	Φ22.2	
	Gas pipe	mm	Φ31.8	Φ38.1
Sound pressure level ³		dB(A)	64	
Net dimensions (WxHxD)		mm	1585x1615x765	
Packed dimensions (WxHxD)		mm	1650x1810x840	
Net weight		kg	338	
Gross weight		kg	362	
Ambient temp.	Cooling	°C	-5 °C to 55 °C	

Notes:

- T1 Cooling: Indoor temperature 27°CDB/19°C WB; Outdoor temperature 35°C DB/24°C WB;
T3 Cooling: Indoor temperature 29°C DB/19°C WB; Outdoor temperature 46°C DB/24°C WB;
Piping length: Interconnecting piping length is 7.5m, level difference is zero.
- Diameters given are those of the unit's accessories.
- Sound pressure level is measured at a position 1m in front of the unit and 1.3m above the floor in a semi-anechoic chamber.

Outdoor unit combinations

System capacity		Number of units	Modules ¹												Outdoor branch joint kit ²		
kW	HP		8	10	12	14	16	18	20	22	24	26	28	30			
22.4	8	1	●														
28.0	10	1		●													
33.5	12	1			●												
40.0	14	1				●											
45.0	16	1					●										
50.0	18	1						●									
56.0	20	1							●								
61.5	22	1								●							
67.0	24	1									●						
73.0	26	1										●					
78.5	28	1											●				
85.0	30	1												●			
90.0	32	2						●	●								
95.0	34	2			●					●							
101.0	36	2						●			●						
106.5	38	2							●			●					
112.0	40	2								●							
118.0	42	2									●						
123.5	44	2										●					
130.0	46	2											●				
134.5	48	2									●			●			
140.0	50	2										●			●		
146.5	52	2											●			●	
151.5	54	2												●	●		
157.0	56	2													●	●	
163.5	58	2														●	●
170.0	60	2														●	●
175.0	62	3							●	●						●	
179.5	64	3								●		●					
185.0	66	3									●		●				
191.5	68	3										●		●			
196.5	70	3											●		●		
202.0	72	3												●	●		
208.5	74	3													●		
215.0	76	3														●	●
218.5	78	3									●			●			
225.0	80	3										●			●		
231.5	82	3											●			●	●
235.5	84	3												●	●		
242.0	86	3													●	●	●
248.5	88	3														●	●
255.0	90	3														●	●

Notes:
 1.The combinations of units shown in the table are factory-recommended. Other combinations of units are also possible.
 2.For systems with two or more outdoor units, outdoor branch joints (sold separately) are required.

Dimensional Drawing (mm)

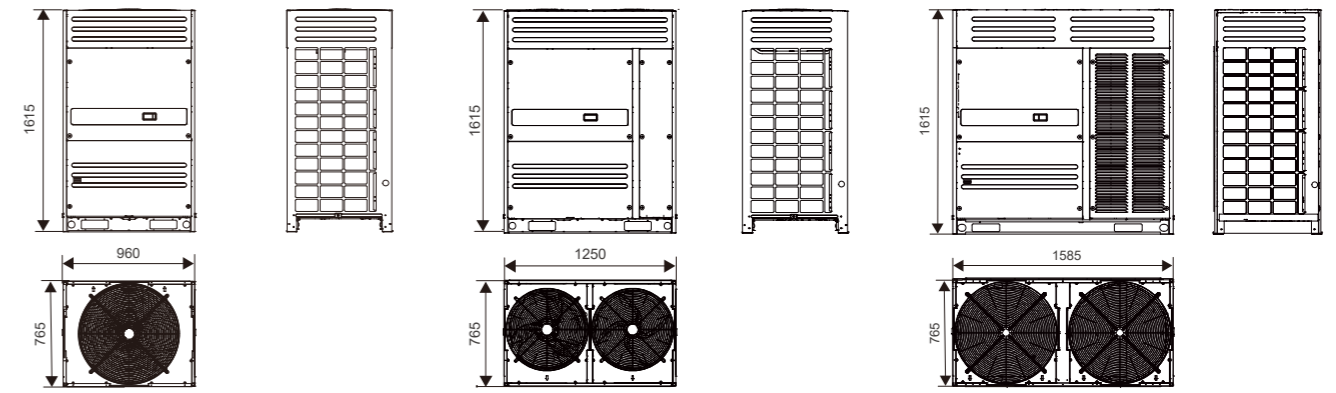

8-16HP

18-22HP

24-30HP

Single Unit installation (mm)

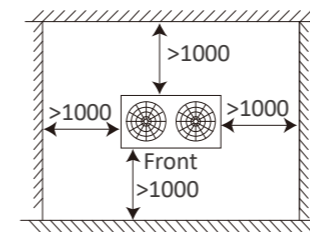

Single Row Installation

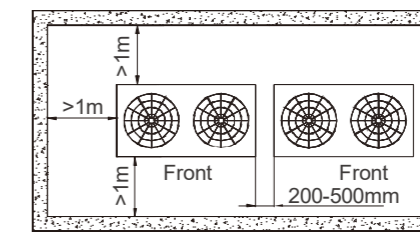

Multi-Row Installation

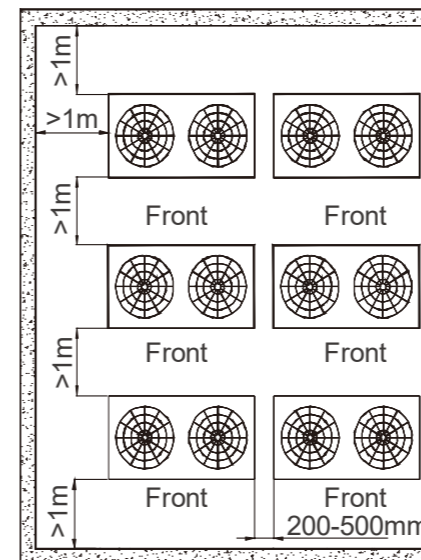

Outdoor unit typical concrete base structure design

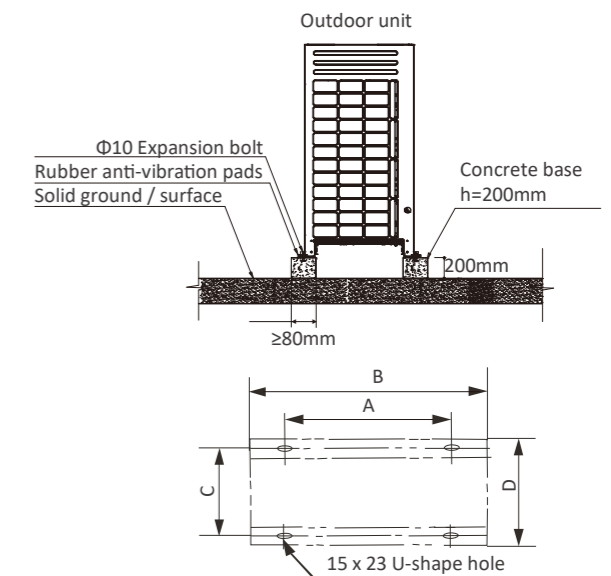

Dimension(mm)	8-16HP	18-22HP	24-30HP
A	830	1120	1455
B	960	1250	1585
C	736	736	736
D	765	765	765