



## 2023 Standard Efficiency Air Conditioner Direct-Drive Packaged Rooftop Unit 3-6 Ton DFC Light Commercial

3-5 TON - 13.4 SEER2/11 EER2

3-5 TON - 14 SEER/11.5 EER

6TON - 15.5 IEER/11.2 EER



\* Complete warranty details available from your local distributor or manufacturer's representative or at [www.daikincomfort.com](http://www.daikincomfort.com) or [www.daikinac.com](http://www.daikinac.com)



## Our Perfect Package:

Harnessing energy-efficient performance, proven technology, and enhanced comfort for life.

Since becoming the first company in Japan to manufacture packaged air conditioning systems, in 1951, Daikin has supported comfortable indoor living based on the strengths and technologies that have led to the growth of the company becoming one of the world's largest manufacturers of HVAC products, systems and refrigerants.

Today, as a comprehensive global manufacturer of HVAC products and systems, the Daikin brand is committed to being recognized as a truly global and excellent company capable of continually creating new value for its customers. The company plans to pursue sustainable growth and foster business operations that consistently harmonize with the goals of improving indoor comfort.

The group philosophy of the company includes:

- » Creating new value continuously for customers
- » Developing world leading energy-saving technology
- » Being a flexible and dynamic organization
- » Allowing employees to be the driving force for the success of the company
- » Fostering an atmosphere of best practices, boldness, and innovation
- » Thinking and acting globally



# Contents

<b>2</b>	<b>Introduction</b>	2
<b>4</b>	<b>Nomenclature</b>	4
<b>5</b>	<b>Features and Benefits</b>	5
	Applications	8
	Serviceability	8
<b>9</b>	<b>Product Specifications</b>	9
	Coil Dimensions	12
	AHRI Ratings	12
	Sound Data	12
<b>13</b>	<b>Expanding Cooling Data</b>	13
<b>21</b>	<b>Electric Heater Data</b>	21
<b>22</b>	<b>Air Flow</b>	22
<b>39</b>	<b>Static Pressure</b>	39
<b>40</b>	<b>Electrical Data</b>	40
<b>49</b>	<b>Wiring Diagrams</b>	49
<b>53</b>	<b>Dimensional Data</b>	53
<b>54</b>	<b>Electrical Connections</b>	54
	Unit Clearances	54
<b>55</b>	<b>Installation</b>	55
	Weights	55

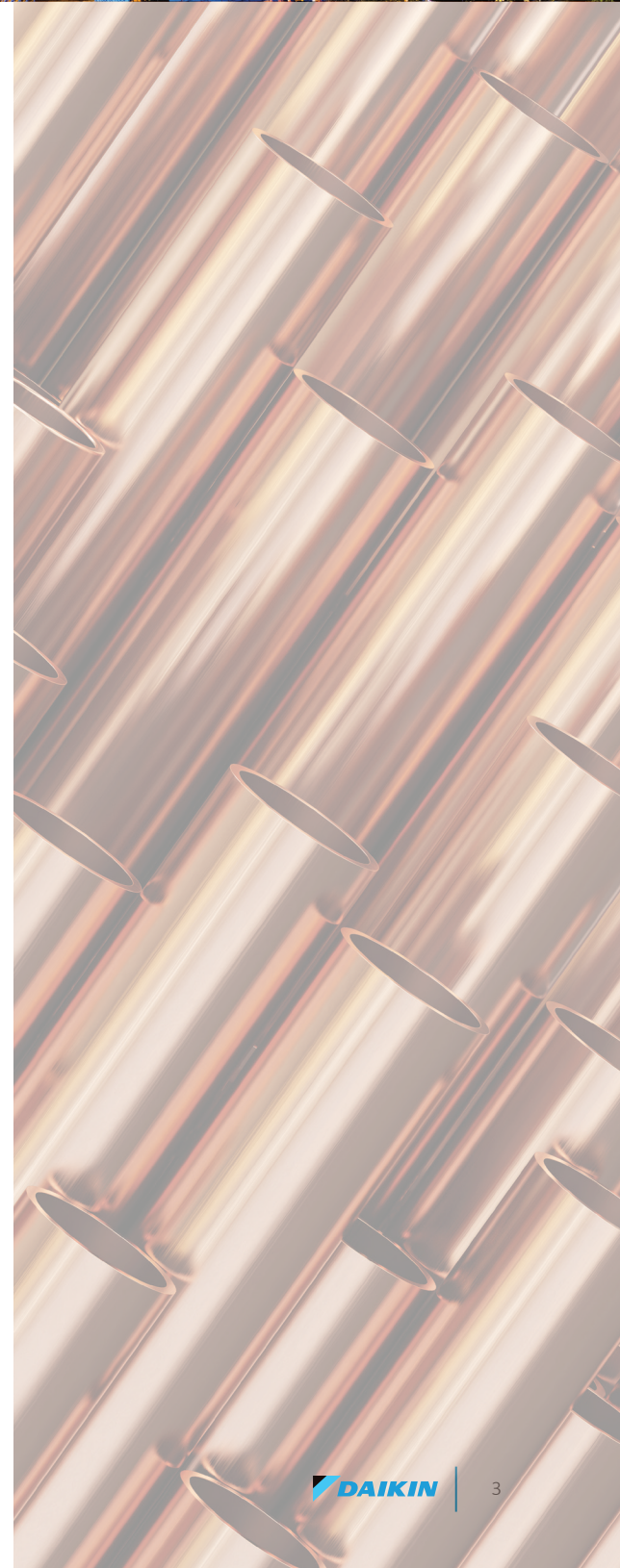

# Nomenclature

	D	F	C	036	3	S	XXX	C	A	A	X	X	X	X	X	X	X	A	*	
	1	2	3	4,5,6	7	8	9,10,11	12	13	14	15	16	17	18	19	20	21	22	23	24
<b>Brand</b>																				<b>Revision Levels</b>
D Daikin																				Major & Minor
<b>Configuration</b>																				
B Base Efficiency																				X No Options
F 2023 Standard Efficiency																				
R High Efficiency																				
<b>Application</b>																				<b>PE Connection</b>
C Cooling																				X No Options
G Gas/Electric																				B Single-point power connection for Power Exhaust
H Heat Pump																				
<b>Nominal Cooling Capacity</b>																				<b>IAQ</b>
036 3 Tons 090 7½ Tons 240 20 Tons																				X No Options
048 4 Tons 102 8½ Tons 300 25 Tons																				
060 5 Tons 120 10 Tons																				
072 6 Tons 150 12½ tons																				
<b>Voltage</b>																				<b>Service Options</b>
1 208-230/1/60 4 460/3/60																				X No Option
3 208-230/3/60 7 575/3/60																				A Powered convenience outlet
<b>Supply Fan/Drive Type/Motor</b>																				B Non-powered convenience outlet
D Direct Drive - Standard Static C Belt-Drive - High Static																				C Hinge Panels
B Belt-Drive - Standard Static S 2-speed Belt Drive - High Static																				D Hinged Panels and Powered convenience outlet
V 2-speed Belt Drive - Standard Static L Direct Drive -Medium Static																				E Hinged Panels and non-powered convenience outlet
W Direct Drive - High Static																				
<b>Nominal Heating Capacity</b>																				<b>Electrical</b>
<b>Gas/Electric</b>																				X No Options
<b>A/C H/P Factory-Installed Electric Heat</b>																				A Non-Fused Disconnect
045 45,000 BTU/h XXX No Heat XXX No Heat																				B Phase Monitor
060 60,000 BTU/h 005 5kW 022 20 kW																				C Thru-the-base connections
070 70,000 BTU/h 006 5kW 023 20 kW																				E Non-Fused Disconnect and Phase Monitor
080 80,000 BTU/h 010 10 kW 030 30 kW																				F Non-Fused Disconnect and Thru-the-base connectons
090 90,000 BTU/h 011 10 kW 031 30 kW																				H Phase Monitor and Thru-the-base connections
100 100,000 BTU/h 015 15 kW 032 30 kW																				L Non-Fused Disconnect, Thru-the-base connectons and Phase Monitor
115 115,000 BTU/h 016 15 kW 045 45kW																				
125 125,000 BTU/h 017 15 kW 046 45kW																				
130 130,000 BTU/h 018 18 kW 060 60kW																				
140 140,000 BTU/h 020 20 kW 075 75kW																				
150 150,000 BTU/h 021 20 kW																				
180 180,000 BTU/h																				
210 210,000 BTU/h																				
225 225,000 BTU/h																				
240 240,000 BTU/h																				
350 350,000 BTU/h																				
400 400,000 BTU/h																				
																				<b>Economizer</b>
																				X No Options
																				A Ultra Low-Leak Downflow Economizer w/ Enthalpy Sensor
																				B Low-Leak Downflow Economizer w/ Enthalpy Sensor
																				E Ultra Low-Leak Downflow Economizer for DDC controls w/ Enthalpy Sensorr
																				G Ultra Low-Leak Downflow Economizer w/ Dry Bulb Sensor
																				H Low-Leak Downflow Economizer w/ Dry Bulb Sensor
																				L Ultra Low-Leak Downflow Economizer for DDC controls w/ Dry Bulb Sensor
																				N Low-Leak Downflow Economizer for DDC controls w/ Enthalpy Sensor
																				P Low-Leak Downflow Economizer for DDC controls w/ Dry Bulb Sensor
<b>Refrigeration Systems</b>																				<b>Coils, Hail guard</b>
A Single stage cooling modes																				X No Options
C Two stage cooling modes																				C Hail Guard
F Two stage cooling modes with Hot Gas Reheat and Low-ambient control																				
<b>Heat Exchanger</b>																				<b>Sensors</b>
X No options																				X No Options
A Standard Aluminized Exchanger																				A RA Smoke Detector
S Stainless Steel Exchanger																				B SA Smoke Detector
U Ultra Low Nox Stainless Steel Exchanger																				C RA & SA Smoke Detector
<b>Controls</b>																				
A Electro-mechanical controls																				
B DDC w/ BACnet interface																				

AC Stocking Models	
New Daikin 3-6 Ton Direct Drive	
MODEL NUMBER	CODESTRING
DFC0361D000001S	DFC0361DXXXXAXXXXXXXXXXX
DFC0363D0000001S	DFC0363DXXXXAXXXXXXXXXXX
DFC0364D0000001S	DFC0364DXXXXAXXXXXXXXXXX
DFC0367D0000001S	DFC0367DXXXXAXXXXXXXXXXX
DFC0481D000001S	DFC0481DXXXXAXXXXXXXXXXX
DFC0483D0000001S	DFC0483DXXXXAXXXXXXXXXXX
DFC0484D0000001S	DFC0484DXXXXAXXXXXXXXXXX
DFC0487D0000001S	DFC0487DXXXXAXXXXXXXXXXX
DFC0601D0000001S	DFC0601DXXXXAXXXXXXXXXXX
DFC0603D0000001S	DFC0603DXXXXAXXXXXXXXXXX
DFC0604D0000001S	DFC0604DXXXXAXXXXXXXXXXX
DFC0607D0000001S	DFC0607DXXXXAXXXXXXXXXXX
DFC0723D000001S	DFC0723DXXXXCAXXXXXXXXXXX
DFC0724D000001S	DFC0724DXXXXCAXXXXXXXXXXX
DFC0727D000001S	DFC0727DXXXXCAXXXXXXXXXXX
DFC0723W000001F	DFC0723WXXXXCAXXXXXXXXXXX
DFC0724W000001F	DFC0724WXXXXCAXXXXXXXXXXX
DFC0727W000001F	DFC0727WXXXXCAXXXXXXXXXXX

## Features and Benefits

---

Daikin Packaged Rooftop Units (RTUs) are built to perform, with features and options that help provide low installation and operation costs, superior indoor air quality, efficient operation, and longevity.

### Installation

Daikin Packaged units are designed with fast and easy installation in mind and are ideal for both new construction and retrofit projects. Our packaged rooftop units are built to be a direct replacement for most rooftop units in the field without the need of a curb adapter.

### Cabinet Construction

Daikin packaged rooftop units are made with high quality galvanized steel with a powder-paint finish to provide higher corrosion resistance.

- » Easy accessibility using our tool-less filter access.
- » Unit is fully insulated to prevent sweating and thermal losses, using our foil face fiberglass insulation which also omits exposed filter fibers into the airstream.
- » 1" Raised flanges around the supply and return.
- » The full perimeter base rail is built using heavy gauge galvanized steel for a stronger structural installation, the

base rails are a minimum of 3 ½" tall and include holes to allow for overhead rigging and lifting with forklifts.

- » Electrical lines and can be brought through the base of the unit or through the horizontal knockout for easy installation and accessibility on the field.

### Compressor

High performance, low noise scroll compressors to match the required total load.

- » Resiliently factory-mounted on rubber grommets for vibration isolation
- » Refrigeration circuit includes both high and low pressure safety switches
- » Unit is factory charged with environmentally friendly R-410A refrigerant.
- » Single stage 3-5 ton, 6 ton 2-stage compressor.
- » Compressor location outside the condenser section to avoid air bypass.
- » Internal overload protection included with compressor.

### Supply Fan

The Direct-Drive airfoil single width, single inlet (SWSI) Class II construction supply fan with aluminum fan blades provides efficient and quiet operation at wide ranging static pressure and air flow requirements.

- » Ball bearing Direct-Drive EEM motor removes the need for belts, sheaves, bearings and lubrication.
- » Each fan assembly is dynamically trim balanced at the factory before shipment for quick start-up and efficient operation.
- » Electromechanical integrated controls modulate the supply fan motor
- » Motor equipped with thermal overload to provide protection and lasting operation.

### Coils

The indoor coil section is installed in a draw through configuration to provide better dehumidification. These coils are constructed with seamless copper tubes, mechanically bonded into aluminum plate-type fins with full drawn collars to completely cover the tubes for high operating efficiencies.

- » Coils are factory pressure tested to ensure pressure and leak integrity.
- » Copper tube / aluminum fin coils on evaporator
- » All units use large face area outdoor coils
- » Microchannel heat exchanger technology on all condenser coils for improved performance and reduced refrigerant load.



### Controls and Wiring

Packaged rooftop units come equipped with a well-organized, large, easy to use weatherproof internal control box with easy access, for a better user experience.

- » Units are factory-wired with color-coded wires and complete 24-volt Electromechanical controls package.
- » Units include single-point power entry as standard.
- » Terminal strips are provided as standard for easy installation and low voltage power wiring

### Filtration

Unit provides a draw-through filter section as standard for better air quality and long lasting component maintenance.

- » Filters installed on the units are standard off the shelf sizes for easy replacement.

### Heating Section

Wide range of electric heat selections effectively handle most comfort heating demands from morning warm-up control to full heat.

### Electric Heat

ETL approved electric heat can be factory assembled, installed and tested.

- » Heating control is fully integrated into the unit's control system for quick start-up and reliable control.
- » Durable low watt density, nickel chromium elements provide longer life (compared to units without).
- » Fuses are provided in each branch circuit to a maximum of 48 Amps per NEC requirements.
- » Single-point power connection reduces installation cost.
- » For operational safeties electric heat includes automatic reset, and high temperature limit safety protection.

### Electrical

Units are completely wired and tested at the factory to provide faster commissioning and start-up.

- » Wiring complies with NEC requirements and all applicable UL standards.
- » For ease of use, wiring and electrical components are color coded and labeled according to the electrical diagram.
- » A 115 V GFI convenience receptacle requiring independent power supply is available as an option.
- » An optional unit powered 20 amp 115 V convenience receptacle, complete with factory mounted transformer, disconnect switch, and primary and secondary overload protection, eliminates the need to pull a separate 115 V power source.
- » Supply air fan, compressor, and condenser fan motor branch circuits have individual short circuit protection.
- » A single-point power connection with power block is standard and a terminal strip is provided for connecting low voltage control wiring.
- » For better serviceability an optional non-fused disconnect switch can be installed and operated by an externally mounted handle to disconnect the electrical power at the unit



### Applications

Daikin Rooftop units are intended for comfort cooling applications in normal heating, ventilating, and air conditioning. Consult your local Daikin sales representative for applications involving operations at high ambient temperatures, high altitudes, non-cataloged voltages, or for job-specific unit selections that fall outside of the range of the catalog tables.

For proper operation, units should be rigged in accordance with instructions stated on the installation manual. Fire dampers, if required, must be installed in the ductwork according to local and/or state codes. No space is allowed for these dampers in the unit.

Follow factory check, test and start procedures explicitly to achieve satisfactory start-up and operation.

Most rooftop applications take advantage of the significant energy savings provided with economizer operation. When an economizer system is used, mechanical refrigeration is typically not required below an ambient temperature of 50°F.

### Serviceability

Daikin packaged rooftop units are built with serviceability in mind, designed to make future maintenance and service on the unit easy and accessible.

- » Our packaged rooftop units offer a slide out blower to facilitate the access and removal of the fan.
- » Filter panels on the small chassis line offer tool-less access for easy maintenance.
- » Independent compressor outside of the air bypass to eliminate component blockage and provide easy access.
- » Color coded wire to identify point-to-point component connections.
- » All 3-6 ton units are designed for convertible airflow orientation to serve downflow or horizontal applications. Every unit ships prepared to convert to horizontal orientation in the field if required.
- » Screw on style high and low pressure switches allow for ease of replacement without the need for refrigerant recovery.





Model	DFC0361D000001S	DFC0363D000001S	DFC0364D000001S	DFC0367D000001S
<b>COOLING CAPACITY</b>				
Total, BTU/h	35,000	35,000	35,000	35,000
SEER / EER	N/A	14.0 / 11.5	14.0 / 11.5	14.0 / 11.5
SEER2 / EER2	13.4 / 11.0	13.4 / 11.0	13.4 / 11.0	13.4 / 11.0
AHRI Reference #	208120664	208120661	208120662	208120663
<b>EVAPORATOR MOTOR / RTPF (ROUND TUBE PLATE FIN)</b>				
Motor Type	Direct Drive	Direct Drive	Direct Drive	Direct Drive
External Static Pressure (ESP)	Standard	Standard	Standard	Standard
Wheel Dia. X Width	12 x 11	12 x 11	12 x 11	12 x 11
Indoor Nominal CFM	1160	1160	1160	1160
RPM	1200/VAR	1200/VAR	300-1500	300-1500
Indoor Horsepower	3/4	3/4	1.2	1.2
Filter Size (in)	20 X 25 X 2 (2)	20 X 25 X 2 (2)	20 X 25 X 2 (2)	20 X 25 X 2 (2)
Drain Size (NPT)	3/4	3/4	3/4	3/4
R-410A Refrigerant Charge (oz.)	52	52	52	52
Evaporator Coil Face Area (ft <sup>2</sup> )	6.41	6.41	6.41	6.41
Rows Deep/ Fins per Inch	2 / 16	2 / 16	2 / 16	2 / 16
<b>CONDENSER FAN / MCHX (MICROCHANNEL HEAT EXCHANGER)</b>				
Quantity of Condenser Fan Motors	1	1	1	1
RPM (High/Low stage)	810	810	810	810
Outdoor Horsepower	1/6	1/6	1/6	1/6
Fan Diameter/ # Fan Blades	22 / 3	22 / 3	22 / 3	22 / 3
Face Area (ft <sup>2</sup> )	12.3	12.3	12.3	12.3
Rows Deep / Fins per Inch	1 / 23	1 / 23	1 / 23	1 / 23
<b>COMPRESSOR (ALL SINGLE-STAGE)</b>				
Quantity / Type / Stages	1 / Scroll / 1	1 / Scroll / 1	1 / Scroll / 1	1 / Scroll / 1
Compressor RLA / LRA	16.7 / 79	10.4 / 73	5.8 / 38	3.8 / 36.5
<b>ELECTRICAL DATA</b>				
Voltage-Phase-Frequency	208/230-1-60	208/230-3-60	460-3-60	575-3-60
Indoor Blower FLA	5.7	5.7	2.5	2
Max External Static (In. W.C.)	0.8	0.8	0.8	0.8
Outdoor Fan FLA	0.95	0.95	0.48	0.39
Min. Circuit Ampacity <sup>1</sup>	27.5/27.5	19.7/19.7	10.2	7.12
Max. Overcurrent Protection (A) <sup>2</sup>	40/40	30/30	15	15
Power Supply Conduit Hole Dia. (in)	1.125	1.125	1.125	1.125
Low-Voltage Conduit Hole Dia. (in)	0.5	0.5	0.5	0.5
<b>OPERATING WEIGHT (LBS.)</b>				
Operating Weight (lbs)	484	482	490	490
<b>SHIPPING WEIGHT (LBS.)</b>				
Ship Weight (lbs)	554	552	560	560

<sup>1</sup> Wire size should be determined in accordance with National Electrical Codes. Extensive wire runs will require larger wire sizes.

<sup>2</sup> May use fuses or HACR-type circuit breakers of the same size as noted.

Note: Always check the S&R plate for electrical data on the unit being installed.

Model	DFC0481D000001S	DFC0483D000001S	DFC0484D000001S	DFC0487D000001S
<b>COOLING CAPACITY</b>				
Total, BTU/h	47,000	47,000	47,000	47,000
SEER / EER	N/A	14.0 / 11.5	14.0 / 11.5	14.0 / 11.5
SEER2 / EER2	13.4 / 11.0	13.4 / 11.0	13.4 / 11.0	13.4 / 11.0
AHRI Reference #	208120672	208120669	208120670	208120671
<b>EVAPORATOR MOTOR / RTPF (ROUND TUBE PLATE FIN)</b>				
Motor Type	Direct Drive	Direct Drive	Direct Drive	Direct Drive
External Static Pressure (ESP)	Standard	Standard	Standard	Standard
Wheel Dia. X Width	12 x 11	12 x 11	12 x 11	12 x 11
Indoor Nominal CFM	1570	1570	1570	1570
RPM	1200/VAR	1200/VAR	300-1500	300-1500
Indoor Horsepower	1.0	1.0	1.2	1.2
Filter Size (in)	20 X 25 X 2 (2)	20 X 25 X 2 (2)	20 X 25 X 2 (2)	20 X 25 X 2 (2)
Drain Size (NPT)	3/4	3/4	3/4	3/4
R-410A Refrigerant Charge (oz.)	79	79	79	79
Evaporator Coil Face Area (ft <sup>2</sup> )	6.41	6.41	6.41	6.41
Rows Deep/ Fins per Inch	3/16	3/16	3/16	3/16
<b>CONDENSER FAN / MCHX (MICROCHANNEL HEAT EXCHANGER)</b>				
Quantity of Condenser Fan Motors	1	1	1	1
RPM (High/Low stage)	1122	1122	1050	1050
Outdoor Horsepower	1/3	1/3	1/3	1/3
Fan Diameter/ # Fan Blades	22 / 3	22 / 3	22 / 3	22 / 3
Face Area (ft <sup>2</sup> )	12.3	12.3	12.3	12.3
Rows Deep / Fins per Inch	1/23	1/23	1/23	1/23
<b>COMPRESSOR (ALL SINGLE-STAGE)</b>				
Quantity / Type / Stages	1 / Scroll / 1	1 / Scroll / 1	1 / Scroll / 1	1 / Scroll / 1
Compressor RLA / LRA	19.9 / 109	13.1 / 83.1	6.1 / 41	4.4 / 33
<b>ELECTRICAL DATA</b>				
Voltage-Phase-Frequency	208/230-1-60	208/230-3-60	460-3-60	575-3-60
Indoor Blower FLA	6.9	6.9	2.5	2
Max External Static (In. W.C.)	0.8	0.8	0.8	0.8
Outdoor Fan FLA	2	2	0.85	0.67
Min. Circuit Ampacity <sup>1</sup>	33.7/33.7	25.3/25.3	11	8.12
Max. Overcurrent Protection (A) <sup>2</sup>	50/50	35/35	15	15
Power Supply Conduit Hole Dia. (in)	1.125	1.125	1.125	1.125
Low-Voltage Conduit Hole Dia. (in)	0.5	0.5	0.5	0.5
<b>OPERATING WEIGHT (LBS.)</b>				
Operating Weight (lbs)	507	502	506	506
<b>SHIPPING WEIGHT (LBS.)</b>				
Ship Weight (lbs)	577	572	576	576

<sup>1</sup> Wire size should be determined in accordance with National Electrical Codes. Extensive wire runs will require larger wire sizes.

<sup>2</sup> May use fuses or HACR-type circuit breakers of the same size as noted.

Note: Always check the S&R plate for electrical data on the unit being installed.

Model	DFC0601D000001S	DFC0603D000001S	DFC0604D000001S	DFC0607D000001S
<b>COOLING CAPACITY</b>				
Total, BTU/h	59,000	59,000	59,000	59,000
SEER / EER	N/A	14/11.5	14/11.5	14/11.5
SEER2 / EER2	13.4/11.0	13.4/11.0	13.4/11.0	13.4/11.0
AHRI Reference #	207516914	207516918	207516919	207516920
<b>EVAPORATOR MOTOR / RTPF (ROUND TUBE PLATE FIN)</b>				
Motor Type	Direct Drive	Direct Drive	Direct Drive	Direct Drive
External Static Pressure (ESP)	Standard	Standard	Standard	Standard
Wheel Dia. X Width	12 x 11	12 x 11	12 x 11	12 x 11
Indoor Nominal CFM	1820	1820	1820	1820
RPM	1200/VAR	1200/VAR	300-1500	300-1500
Indoor Horsepower	1.0	1.0	1.2	1.2
Filter Size (in)	20 X 25 X 2 (2)	20 X 25 X 2 (2)	20 X 25 X 2 (2)	20 X 25 X 2 (2)
Drain Size (NPT)	¾	¾	¾	¾
R-410A Refrigerant Charge (oz.)	82	82	82	82
Evaporator Coil Face Area (ft²)	6.4	6.4	6.4	6.4
Rows Deep/ Fins per Inch	3/16	3/16	3/16	3/16
<b>CONDENSER FAN / MCHX (MICROCHANNEL HEAT EXCHANGER)</b>				
Quantity of Condenser Fan Motors	1	1	1	1
RPM (High/Low stage)	1122	1122	1050	1050
Outdoor Horsepower	1/3	1/3	1/3	1/3
Fan Diameter/ # Fan Blades	22 / 3	22 / 3	22 / 3	22 / 3
Face Area (ft²)	17.6	17.6	17.6	17.6
Rows Deep / Fins per Inch	1/23	1/23	1 / 23	1/23
<b>COMPRESSOR (ALL SINGLE-STAGE)</b>				
Quantity / Type / Stages	1 / Scroll / 1	1 / Scroll / 1	1 / Scroll / 1	1 / Scroll / 1
Compressor RLA / LRA	26.4 / 134.0	16.0 / 110.0	7.8 / 52.0	5.7 / 38.9
<b>ELECTRICAL DATA</b>				
Voltage-Phase-Frequency	208/230-1-60	208/230-3-60	460-3-60	575-3-60
Indoor Blower FLA	6.9	6.9	2.5	2.0
Max External Static (In. W.C.)	0.8	0.8	0.8	0.8
Outdoor Fan FLA	2.0	2.0	0.85	0.67
Min. Circuit Ampacity <sup>1</sup>	41.9 / 41.9	28.9 / 28.9	13	9.8
Max. Overcurrent Protection (A) <sup>2</sup>	60 / 60	40 / 40	20	15
Power Supply Conduit Hole Dia. (in)	1.125	1.125	1.125	1.125
Low-Voltage Conduit Hole Dia. (in)	0.5	0.5	0.5	0.5
<b>OPERATING WEIGHT (LBS.)</b>				
Operating Weight (lbs)	512	508	512	512
<b>SHIPPING WEIGHT (LBS.)</b>				
Ship Weight (lbs)	582	578	582	582

<sup>1</sup> Wire size should be determined in accordance with National Electrical Codes. Extensive wire runs will require larger wire sizes.

<sup>2</sup> May use fuses or HACR-type circuit breakers of the same size as noted.

Note: Always check the S&R plate for electrical data on the unit being installed.

Model	DFC0723D000001S	DFC0724D000001S	DFC0727D000001S	DFC0723W000001F	DFC0724W000001F	DFC0727W000001F
<b>COOLING CAPACITY</b>						
Total, BTU/h	69,000	69,000	69,000	69,000	69,000	69,000
IEER /EER	15.5/11.2	15.5/11.2	15.5/11.2	15.5/11.2	15.5/11.2	15.5/11.2
AHRI Reference #	208122215	208122216	208122217	208122215	208122216	208122217
<b>EVAPORATOR MOTOR / RTPF (ROUND TUBE PLATE FIN)</b>						
Motor Type	Direct Drive	Direct Drive	Direct Drive	Direct Drive	Direct Drive	Direct Drive
External Static Pressure (ESP)	Standard	Standard	Standard	High	High	High
Wheel Dia. X Width	12 x 11	12 x 11	12 x 11	12 x 11	12 x 11	12 x 11
Indoor Nominal CFM	2100	2100	2100	2100	2100	2100
RPM	300-1500	300-1500	300-1500	300-1500	300-1500	300-1500
Indoor Horsepower	1.2	1.2	1.2	2.3	2.3	2.3
Filter Size (in)	14 X 20 X 2 20 X 20 X 2	14 X 20 X 2 20 X 20 X 2	14 X 20 X 2 20 X 20 X 2	14 X 20 X 2 20 X 20 X 2	14 X 20 X 2 20 X 20 X 2	14 X 20 X 2 20 X 20 X 2
Drain Size (NPT)	3/4	3/4	3/4	3/4	3/4	3/4
R-410A Refrigerant Charge (oz.)	110	110	110	110	110	110
Evaporator Coil Face Area (ft <sup>2</sup> )	9.16	9.16	9.16	9.16	9.16	9.16
Rows Deep/ Fins per Inch	3 / 16	3 / 16	3 / 16	3 / 16	3 / 16	3 / 16
<b>CONDENSER FAN / MCHX (MICROCHANNEL HEAT EXCHANGER)</b>						
Quantity of Condenser Fan Motors	1	1	1	1	1	1
RPM (High/Low stage)	1122	1050	1050	1122	1050	1050
Outdoor Horsepower	1/3	1/3	1/3	1/3	1/3	1/3
Fan Diameter/ # Fan Blades	22 / 4	22 / 4	22 / 4	22 / 4	22 / 4	22 / 4
Face Area (ft <sup>2</sup> )	17.2	17.2	17.2	17.2	17.2	17.2
Rows Deep / Fins per Inch	1 / 23	1 / 23	1 / 23	1 / 23	1 / 23	1 / 23
<b>COMPRESSOR (ALL SINGLE-STAGE)</b>						
Quantity / Type / Stages	1 / Scroll / 2	1 / Scroll / 2	1 / Scroll / 2	1 / Scroll / 2	1 / Scroll / 2	1 / Scroll / 2
Compressor RLA / LRA	17.6 / 136	8.5 / 66.1	6.3 / 55.3	17.6 / 136	8.5 / 66.1	6.3 / 55.3
<b>ELECTRICAL DATA</b>						
Voltage-Phase-Frequency	208/230-3-60	460-3-60	575-3-60	208/230-3-60	460-3-60	575-3-60
Indoor Blower FLA	5	2.5	2	7.7	4.5	3.8
Max External Static (In. W.C.)	0.8	0.8	0.8	1.8	1.8	1.8
Outdoor Fan FLA	2	0.85	0.67	2	0.85	0.67
Min. Circuit Ampacity <sup>1</sup>	29.0/29.0	13.9	10.6	31.7/31.7	15.9	12.4
Max. Overcurrent Protection (A) <sup>2</sup>	45/45	20	15	45/45	20	15
Power Supply Conduit Hole Dia. (in)	1.125	1.125	1.125	1.125	1.125	1.125
Low-Voltage Conduit Hole Dia. (in)	0.5	0.5	0.5	0.5	0.5	0.5
<b>OPERATING WEIGHT (LBS.)</b>						
Operating Weight (lbs)	581	581	581	585	585	585
<b>SHIPPING WEIGHT (LBS.)</b>						
Ship Weight (lbs)	651	651	651	655	655	655

<sup>1</sup> Wire size should be determined in accordance with National Electrical Codes. Extensive wire runs will require larger wire sizes.

<sup>2</sup> May use fuses or HACR-type circuit breakers of the same size as noted.

Note: Always check the S&R plate for electrical data on the unit being installed.

### Coil Dimensions

Model	Tons	Fin height in.	Fin length in.
DFC	3	24.248	38.068
DFC	4	24.248	38.068
DFC	5	24.248	38.068
DFC	6	34.640	38.068

### AHRI Ratings

MODEL	CAPACITY	EER2	SEER2	EER	SEER	IEER
DFC036	35,000	11.0	13.4	11.5	14.0	-
DFC048	47,000	11.0	13.4	11.5	14.0	-
DFC060	59,000	11.0	13.4	11.5	14.0	-
DFC072	69,000	-	-	11.2	-	15.5

### Sound Data

Model	OUTDOOR SOUND (DB) AT 60 Hz							
	A-Weighted	125	250	500	1000	2000	4000	8000
036	73	77.7	71.0	69.5	68.0	64.7	60.5	60.4
048	78.4	69.8	70.1	73.1	73.7	67.4	61.2	53.0
060	78.3	65.9	68.3	70.3	74.3	72.1	65.8	60.3
072	82	77.6	79.4	78.1	76.8	73.4	70.5	68.5

**Notes:**

<sup>1</sup> Outdoor sound data is measured in accordance with AHRI standard 270.

<sup>2</sup> Measurements are expressed in terms of sound power. Do not compare these values to sound pressure values because sound pressure depends on specific environment factors which normally do not match individual applications. Sound power values are independent of the environment and therefore more accurate.

<sup>3</sup> A-weighted sound ratings filter out high and very low frequencies, to better approximate the response of "average" human ear. A-weighted measurements for Daikin units are taken in accordance with AHRI standard 270.

IDB Airflow		Outdoor Ambient Temperature																							
		65				75				85				95				105				115			
		59	63	67	71	59	63	67	71	59	63	67	71	59	63	67	71	59	63	67	71	59	63	67	71
		Entering Indoor Wet Bulb Temperature																							
900	Capacity	35,794	36,304	37,383	-	35,471	35,981	37,060	-	34,528	35,038	36,117	-	32,905	33,415	34,494	-	30,922	31,432	32,511	-	29,111	29,622	30,701	-
	S/T	0.53	0.45	0.32	-	0.54	0.46	0.33	-	0.56	0.48	0.35	-	0.58	0.50	0.37	-	0.60	0.53	0.39	-	1.00	0.58	0.44	-
	Evap dT	19.72	17.99	14.76	-	19.67	17.94	14.71	-	19.92	18.19	14.96	-	19.66	17.93	14.70	-	19.43	17.70	14.47	-	20.51	18.78	15.55	-
	Pr Suc	117	119	122	-	125	126	129	-	131	132	135	-	136	138	141	-	142	143	146	-	148	150	153	-
	Pr Dis	253	254	256	-	294	295	297	-	336	337	339	-	381	382	384	-	430	431	433	-	483	484	485	-
TotalPower	2,091	2,089	2,085	-	2,350	2,348	2,344	-	2,640	2,638	2,633	-	2,953	2,951	2,946	-	3,302	3,300	3,296	-	3,713	3,711	3,706	-	
70	Capacity	36,592	37,102	38,181	-	36,268	36,778	37,857	-	35,325	35,835	36,914	-	33,703	34,213	35,292	-	31,720	32,230	33,309	-	29,909	30,419	31,498	-
	S/T	0.66	0.58	0.45	-	0.66	0.59	0.45	-	0.69	0.61	0.48	-	0.71	0.63	0.50	-	1.00	0.65	0.52	-	1.00	0.71	0.57	-
	Evap dT	17.66	15.93	12.70	-	17.62	15.88	12.65	-	17.86	16.13	12.90	-	17.60	15.87	12.64	-	17.37	15.64	12.41	-	18.45	16.72	13.49	-
	Pr Suc	120	122	125	-	128	129	132	-	134	135	138	-	139	141	144	-	145	146	149	-	151	153	156	-
	Pr Dis	257	259	260	-	298	299	301	-	340	341	343	-	385	386	388	-	434	435	437	-	487	488	489	-
TotalPower	2,118	2,116	2,111	-	2,377	2,375	2,370	-	2,666	2,664	2,660	-	2,979	2,977	2,973	-	3,329	3,327	3,323	-	3,739	3,737	3,733	-	
1350	Capacity	37,361	37,871	38,950	-	37,037	37,548	38,627	-	36,094	36,604	37,683	-	34,472	34,982	36,061	-	32,489	32,999	34,078	-	30,678	31,188	32,267	-
	S/T	0.70	0.62	0.49	-	0.70	0.63	0.49	-	0.73	0.65	0.52	-	0.75	0.67	0.54	-	1.00	0.69	0.56	-	1.00	0.74	0.61	-
	Evap dT	16.53	14.80	11.57	-	16.48	14.75	11.52	-	16.73	15.00	11.77	-	16.47	14.74	11.51	-	16.24	14.51	11.28	-	17.32	15.59	12.36	-
	Pr Suc	123	124	128	-	130	132	135	-	137	138	141	-	142	143	146	-	147	149	152	-	154	155	158	-
	Pr Dis	260	261	263	-	300	302	303	-	343	344	346	-	388	389	391	-	437	438	440	-	489	490	492	-
TotalPower	2,132	2,130	2,126	-	2,391	2,389	2,385	-	2,681	2,679	2,674	-	2,994	2,992	2,987	-	3,343	3,341	3,337	-	3,754	3,752	3,747	-	
900	Capacity	35,815	36,325	37,404	39,052	35,492	36,002	37,081	38,729	34,549	35,059	36,138	37,786	32,926	33,436	34,515	36,163	30,943	31,453	32,532	34,180	29,133	29,643	30,722	32,370
	S/T	0.66	0.58	0.45	0.31	0.66	0.59	0.45	0.31	0.69	0.61	0.48	0.34	1.00	0.63	0.50	0.36	1.00	0.65	0.52	0.38	1.00	0.70	0.57	0.43
	Evap dT	23.53	21.80	18.57	15.22	23.48	21.75	18.52	15.17	23.72	21.99	18.76	15.41	23.46	21.73	18.50	15.15	23.23	21.50	18.27	14.92	24.31	22.58	19.35	16.01
	Pr Suc	117	119	122	127	125	126	129	134	131	132	135	141	136	138	141	146	142	143	146	151	148	150	153	158
	Pr Dis	254	255	256	261	294	295	297	301	336	337	339	343	381	383	384	389	430	432	433	438	483	484	486	490
TotalPower	2,089	2,087	2,083	2,103	2,349	2,347	2,342	2,362	2,638	2,636	2,631	2,651	2,951	2,949	2,944	2,964	3,301	3,299	3,294	3,314	3,711	3,709	3,705	3,725	
75	Capacity	36,613	37,123	38,202	39,850	36,289	36,799	37,878	39,526	35,346	35,856	36,935	38,583	33,724	34,234	35,313	36,961	31,741	32,251	33,330	34,978	29,930	30,440	31,519	33,167
	S/T	0.79	0.71	0.58	0.44	0.79	0.72	0.58	0.44	1.00	0.74	0.61	0.47	1.00	0.76	0.63	0.49	1.00	0.78	0.65	0.51	1.00	0.83	0.70	0.56
	Evap dT	21.47	19.74	16.51	13.16	21.42	19.69	16.46	13.11	21.66	19.93	16.70	13.36	21.40	19.67	16.44	13.09	21.17	19.44	16.21	12.86	22.25	20.52	17.29	13.95
	Pr Suc	120	122	125	130	128	129	132	137	134	135	139	144	139	141	144	149	145	146	149	154	151	153	156	161
	Pr Dis	258	259	261	265	298	299	301	305	340	341	343	347	386	387	388	393	435	436	437	442	487	488	490	494
TotalPower	2,116	2,114	2,109	2,129	2,375	2,373	2,369	2,388	2,664	2,662	2,658	2,678	2,977	2,975	2,971	2,991	3,327	3,325	3,321	3,341	3,738	3,736	3,731	3,751	
1350	Capacity	37,382	37,892	38,971	40,619	37,059	37,569	38,648	40,296	36,115	36,626	37,704	39,352	34,493	35,003	36,082	37,730	32,510	33,020	34,099	35,747	30,699	31,209	32,288	33,936
	S/T	0.82	0.75	0.62	0.47	0.83	0.76	0.62	0.48	1.00	0.78	0.65	0.51	1.00	0.80	0.67	0.52	1.00	0.82	0.69	0.55	1.00	1.00	0.74	0.60
	Evap dT	20.34	18.61	15.38	12.03	20.29	18.56	15.33	11.98	20.53	18.80	15.57	12.22	20.27	18.54	15.31	11.96	20.04	18.31	15.08	11.73	21.12	19.39	16.16	12.82
	Pr Suc	123	125	128	133	130	132	135	140	137	138	141	146	142	143	146	152	147	149	152	157	154	155	158	163
	Pr Dis	260	261	263	268	301	302	304	308	343	344	346	350	388	389	391	396	437	438	440	445	490	491	492	497
TotalPower	2,130	2,128	2,124	2,144	2,390	2,388	2,383	2,403	2,679	2,677	2,672	2,692	2,992	2,990	2,985	3,005	3,342	3,340	3,335	3,355	3,752	3,750	3,746	3,766	

W = Total system power  
 Amps: Unit amps (comp.+ evaporator + condenser fan motors)  
 Design Subcooling: 16 - 19 °F @ the liquid access fitting connection.

Shaded area reflects ACCA (TVA) conditions

IDB: Entering Indoor Dry Bulb Temperature  
 High and low pressures are measured at the liquid and suction access fittings.  
 Design Subcooling: 16 - 19 °F @ the liquid access fitting connection ARI 95 test conditions. Design Superheat 8 - 12°F @ the compressor suction access fitting connection.

IDB Airflow		Outdoor Ambient Temperature												Entering Indoor Wet Bulb Temperature											
		65				75				85				95				105				115			
		59	63	67	71	59	63	67	71	59	63	67	71	59	63	67	71	59	63	67	71	59	63	67	71
900	Capacity	36,002	36,512	37,591	39,239	35,679	36,189	37,268	38,916	34,736	35,246	36,325	37,973	33,113	33,623	34,702	36,350	31,130	31,640	32,719	34,367	29,320	29,830	30,909	32,557
	S/T	0.78	0.71	0.57	0.43	1.00	0.71	0.58	0.44	1.00	0.74	0.60	0.46	1.00	0.76	0.62	0.48	1.00	0.78	0.64	0.50	1.00	1.00	0.69	0.55
	Evap dT	27.36	25.63	22.40	19.05	27.31	25.58	22.35	19.00	27.55	25.82	22.59	19.24	27.29	25.56	22.33	18.98	27.06	25.33	22.10	18.75	28.14	26.41	23.18	19.84
	Pr Suc	118	119	122	127	125	127	130	135	131	133	136	141	137	138	141	146	142	144	147	152	149	150	153	158
	Pr Dis	254	255	257	261	294	295	297	302	337	338	339	344	382	383	385	389	431	432	434	438	483	484	486	491
TotalPower	2,091	2,089	2,084	2,104	2,350	2,348	2,343	2,363	2,639	2,637	2,633	2,653	2,952	2,950	2,946	2,966	3,302	3,300	3,296	3,315	3,713	3,711	3,706	3,726	
80	Capacity	36,800	37,310	38,389	40,037	36,476	36,987	38,066	39,714	35,533	36,043	37,122	38,770	33,911	34,421	35,500	37,148	31,928	32,438	33,517	35,165	30,117	30,627	31,706	33,354
	S/T	0.91	0.83	0.70	0.56	1.00	0.84	0.71	0.57	1.00	0.86	0.73	0.59	1.00	0.88	0.75	0.61	1.00	1.00	0.77	0.63	1.00	1.00	0.82	0.68
	Evap dT	25.30	23.57	20.34	16.99	25.25	23.52	20.29	16.94	25.49	23.76	20.53	17.18	25.23	23.50	20.27	16.92	25.00	23.27	20.04	16.69	26.08	24.35	21.12	17.78
	Pr Suc	121	122	125	131	128	130	133	138	135	136	139	144	140	141	144	149	145	147	150	155	152	153	156	161
	Pr Dis	258	259	261	265	298	299	301	306	341	342	343	348	386	387	389	393	435	436	438	442	487	488	490	495
TotalPower	2,117	2,115	2,111	2,131	2,376	2,374	2,370	2,390	2,666	2,664	2,659	2,679	2,979	2,977	2,972	2,992	3,329	3,327	3,322	3,342	3,739	3,737	3,733	3,752	
1350	Capacity	37,569	38,079	39,158	40,806	37,246	37,756	38,835	40,483	36,303	36,813	37,892	39,540	34,680	35,190	36,269	37,917	32,697	33,207	34,286	35,934	30,886	31,397	32,476	34,124
	S/T	1.00	0.87	0.74	0.60	1.00	0.88	0.75	0.60	1.00	0.90	0.77	0.63	1.00	0.92	0.79	0.65	1.00	1.00	0.81	0.67	1.00	1.00	0.86	0.72
	Evap dT	24.17	22.44	19.21	15.86	24.12	22.39	19.16	15.81	24.36	22.63	19.40	16.05	24.10	22.37	19.14	15.79	23.87	22.14	18.91	15.56	24.95	23.22	19.99	16.65
	Pr Suc	124	125	128	133	131	132	135	140	137	139	142	147	142	144	147	152	148	149	152	157	154	156	159	164
	Pr Dis	261	262	264	268	301	302	304	308	343	344	346	351	389	390	392	396	438	439	441	445	490	491	493	497
TotalPower	2,132	2,130	2,125	2,145	2,391	2,389	2,384	2,404	2,680	2,678	2,674	2,694	2,993	2,991	2,987	3,007	3,343	3,341	3,337	3,356	3,754	3,751	3,747	3,767	
900	Capacity	36,611	37,121	38,200	39,848	36,287	36,797	37,876	39,524	35,344	35,854	36,933	38,581	33,722	34,232	35,311	36,959	31,739	32,249	33,328	34,976	29,928	30,438	31,517	33,165
	S/T	1.00	0.81	0.67	0.53	1.00	0.81	0.68	0.54	1.00	0.84	0.70	0.56	1.00	1.00	0.72	0.58	1.00	1.00	0.74	0.60	1.00	1.00	0.79	0.65
	Evap dT	30.75	29.02	25.79	22.45	30.71	28.98	25.74	22.40	30.95	29.22	25.99	22.64	30.69	28.96	25.73	22.38	30.46	28.73	25.50	22.15	31.54	29.81	26.58	23.23
	Pr Suc	120	121	124	129	127	128	131	136	133	135	138	143	139	140	143	148	144	145	148	153	150	152	155	160
	Pr Dis	255	256	258	263	296	297	298	303	338	339	341	345	383	384	386	390	432	433	435	439	484	486	487	492
TotalPower	2,096	2,094	2,089	2,109	2,355	2,353	2,348	2,368	2,644	2,642	2,638	2,658	2,957	2,955	2,951	2,971	3,307	3,305	3,301	3,320	3,717	3,715	3,711	3,731	
85	Capacity	37,408	37,918	38,997	40,645	37,085	37,595	38,674	40,322	36,142	36,652	37,731	39,379	34,519	35,029	36,108	37,756	32,536	33,046	34,125	35,773	30,726	31,236	32,315	33,963
	S/T	1.00	0.93	0.80	0.66	1.00	0.94	0.81	0.67	1.00	1.00	0.83	0.69	1.00	1.00	0.85	0.71	1.00	1.00	0.87	0.73	1.00	1.00	0.923	0.782
	Evap dT	28.69	26.96	23.73	20.39	28.65	26.92	23.69	20.34	28.89	27.16	23.93	20.58	28.63	26.90	23.67	20.32	28.40	26.67	23.44	20.09	29.48	27.75	24.52	21.17
	Pr Suc	123	124	127	132	130	131	134	140	136	138	141	146	142	143	146	151	147	148	151	156	153	155	158	163
	Pr Dis	259	260	262	267	300	301	302	307	342	343	345	349	387	388	390	395	436	437	439	444	488	490	491	496
TotalPower	2,122	2,120	2,116	2,136	2,381	2,379	2,375	2,395	2,671	2,669	2,664	2,684	2,984	2,982	2,977	2,997	3,334	3,332	3,327	3,347	3,744	3,742	3,738	3,757	
1350	Capacity	38,177	38,688	39,767	41,415	37,854	38,364	39,443	41,091	36,911	37,421	38,500	40,148	35,288	35,799	36,877	38,526	33,305	33,816	34,894	36,542	31,495	32,005	33,084	34,732
	S/T	1.00	0.97	0.84	0.70	1.00	0.98	0.85	0.70	1.00	1.00	0.87	0.73	1.00	1.00	0.89	0.75	1.00	1.00	0.91	0.77	1.00	1.00	1.00	0.82
	Evap dT	27.56	25.83	22.60	19.26	27.52	25.79	22.55	19.21	27.76	26.03	22.80	19.45	27.50	25.77	22.54	19.19	27.27	25.54	22.31	18.96	28.35	26.62	23.39	20.04
	Pr Suc	125	127	130	135	133	134	137	142	139	140	143	148	144	146	149	154	150	151	154	159	156	158	161	166
	Pr Dis	262	263	265	269	302	303	305	310	345	346	347	352	390	391	393	397	439	440	442	446	491	492	494	499
TotalPower	2,137	2,135	2,130	2,150	2,396	2,394	2,389	2,409	2,685	2,683	2,679	2,699	2,998	2,996	2,992	3,012	3,348	3,346	3,342	3,361	3,758	3,756	3,752	3,772	

IDB: Entering Indoor Dry Bulb Temperature  
 High and low pressures are measured at the liquid and suction access fittings.  
 Design Subcooling, 16 - 19 °F @ the liquid access fitting connection ARI 95 test conditions. Design Superheat 8 - 12°F @ the compressor suction access fitting connection.  
 Shaded area reflects AHRI (TVA) conditions  
 W = Total system power  
 Amps: Unit amps (comp.+ evaporator + condenser fan motors)

IDB Airflow		Outdoor Ambient Temperature																								
		65				75				85				95				105				115				
		59	63	67	71	59	63	67	71	59	63	67	71	59	63	67	71	59	63	67	71	59	63	67	71	
70	Capacity	47,343	48,018	49,446	-	46,914	47,590	49,018	-	45,666	46,341	47,770	-	43,518	44,193	45,621	-	40,892	41,568	42,996	-	38,495	39,171	40,599	-	
		S/T	0.53	0.46	0.32	-	0.54	0.46	0.33	-	0.57	0.49	0.35	-	0.59	0.51	0.37	-	1.00	0.53	0.39	-	1.00	0.58	0.45	-
	Evap dT	19.71	17.99	14.78	-	19.66	17.94	14.74	-	19.90	18.18	14.98	-	19.64	17.93	14.72	-	19.41	17.70	14.49	-	20.49	18.77	15.56	-	
		Pr Suc	121	122	126	-	128	130	133	-	135	136	139	-	140	142	145	-	146	147	150	-	153	154	157	-
	Pr Dis	252	253	255	-	292	293	295	-	334	335	337	-	379	380	382	-	428	429	431	-	480	481	483	-	
		TotalPower	2,821	2,818	2,813	-	3,135	3,132	3,127	-	3,486	3,483	3,478	-	3,865	3,863	3,857	-	4,289	4,287	4,281	-	4,787	4,784	4,779	-
	75	Capacity	48,445	49,121	50,549	-	48,017	48,693	50,121	-	46,769	47,444	48,872	-	44,620	45,296	46,724	-	41,995	42,670	44,099	-	39,598	40,273	41,702	-
			S/T	0.68	0.60	0.46	-	0.68	0.61	0.47	-	0.71	0.63	0.49	-	1.00	0.65	0.51	-	1.00	0.67	0.54	-	1.00	0.73	0.59
		Evap dT	17.53	15.81	12.61	-	17.48	15.77	12.56	-	17.73	16.01	12.80	-	17.47	15.75	12.54	-	17.24	15.52	12.31	-	18.31	16.59	13.39	-
			Pr Suc	124	126	129	-	132	133	136	-	138	140	143	-	144	145	148	-	149	151	154	-	156	157	161
Pr Dis		256	257	259	-	296	297	299	-	338	339	341	-	383	385	386	-	432	433	435	-	484	485	487	-	
		TotalPower	2,855	2,852	2,847	-	3,169	3,167	3,161	-	3,520	3,517	3,512	-	3,899	3,897	3,892	-	4,323	4,321	4,316	-	4,821	4,819	4,813	-
1570		Capacity	49,344	50,019	51,448	-	48,916	49,591	51,020	-	47,667	48,343	49,771	-	45,519	46,194	47,623	-	42,894	43,569	44,997	-	40,497	41,172	42,601	-
			S/T	0.72	0.64	0.50	-	0.72	0.64	0.51	-	0.75	0.67	0.53	-	1.00	0.69	0.55	-	1.00	0.71	0.57	-	1.00	0.76	0.63
		Evap dT	16.52	14.80	11.60	-	16.47	14.75	11.55	-	16.71	15.00	11.79	-	16.45	14.74	11.53	-	16.22	14.51	11.30	-	17.30	15.58	12.38	-
			Pr Suc	127	128	131	-	134	136	139	-	141	142	145	-	146	148	151	-	151	153	156	-	158	160	163
	Pr Dis	259	260	261	-	299	300	302	-	341	342	344	-	386	387	389	-	435	436	438	-	487	488	490	-	
		TotalPower	2,871	2,868	2,863	-	3,185	3,182	3,177	-	3,536	3,533	3,528	-	3,915	3,913	3,907	-	4,339	4,337	4,331	-	4,837	4,834	4,829	-
	1800	Capacity	47,370	48,046	49,474	51,656	46,942	47,618	49,046	51,228	45,694	46,369	47,798	49,979	43,545	44,221	45,649	47,831	40,920	41,595	43,024	45,206	38,523	39,199	40,627	42,809
			S/T	0.67	0.59	0.45	0.31	0.67	0.59	0.46	0.31	1.00	0.62	0.48	0.34	1.00	0.64	0.50	0.36	1.00	0.66	0.52	0.38	1.00	0.71	0.58
		Evap dT	23.48	21.77	18.56	15.24	23.44	21.72	18.51	15.19	23.68	21.96	18.75	15.43	23.42	21.70	18.49	15.17	23.19	21.47	18.27	14.94	24.26	22.55	19.34	16.02
			Pr Suc	121	122	126	131	128	130	133	138	135	136	140	145	140	142	145	150	146	147	150	156	153	154	157
Pr Dis		252	253	255	259	292	293	295	300	334	335	337	342	379	381	382	387	428	429	431	435	480	481	483	487	
		TotalPower	2,819	2,816	2,811	2,835	3,133	3,130	3,125	3,149	3,484	3,481	3,476	3,500	3,863	3,861	3,855	3,879	4,287	4,285	4,279	4,303	4,785	4,782	4,777	4,801
75		Capacity	48,473	49,148	50,577	52,759	48,045	48,720	50,149	52,331	46,796	47,472	48,900	51,082	44,648	45,324	46,752	48,934	42,023	42,698	44,127	46,308	39,626	40,301	41,730	43,912
			S/T	0.81	0.73	0.59	0.45	0.81	0.74	0.60	0.45	1.00	0.76	0.62	0.48	1.00	0.78	0.64	0.50	1.00	0.81	0.67	0.52	1.00	1.00	0.72
		Evap dT	21.31	19.59	16.38	13.06	21.26	19.54	16.34	13.01	21.50	19.78	16.58	13.26	21.24	19.52	16.32	13.00	21.01	19.30	16.09	12.77	22.09	20.37	17.16	13.84
			Pr Suc	124	126	129	134	132	133	136	142	138	140	143	148	144	145	148	154	149	151	154	159	156	157	161
	Pr Dis	256	257	259	264	296	298	299	304	338	340	341	346	384	385	387	391	432	434	435	440	484	486	487	492	
		TotalPower	2,853	2,850	2,845	2,869	3,167	3,165	3,159	3,183	3,518	3,515	3,510	3,534	3,897	3,895	3,889	3,914	4,321	4,319	4,314	4,338	4,819	4,816	4,811	4,835
	1570	Capacity	49,372	50,047	51,476	53,658	48,944	49,619	51,048	53,230	47,695	48,371	49,799	51,981	45,547	46,222	47,651	49,833	42,922	43,597	45,025	47,207	40,525	41,200	42,629	44,810
			S/T	0.85	0.77	0.63	0.49	1.00	0.78	0.64	0.49	1.00	0.80	0.66	0.52	1.00	0.82	0.68	0.54	1.00	0.84	0.71	0.56	1.00	1.00	0.76
		Evap dT	20.29	18.58	15.37	12.05	20.25	18.53	15.32	12.00	20.49	18.77	15.57	12.24	20.23	18.51	15.31	11.98	20.00	18.28	15.08	11.76	21.08	19.36	16.15	12.83
			Pr Suc	127	128	131	136	134	136	139	144	141	142	145	150	146	148	151	156	152	153	156	161	158	160	163
Pr Dis		259	260	262	266	299	300	302	306	341	342	344	348	386	387	389	393	435	436	438	442	487	488	490	494	
		TotalPower	2,869	2,866	2,861	2,885	3,183	3,180	3,175	3,199	3,534	3,531	3,526	3,550	3,913	3,911	3,905	3,929	4,337	4,335	4,329	4,353	4,835	4,832	4,827	4,851

IDB: Entering Indoor Dry Bulb Temperature  
 High and low pressures are measured at the liquid and suction access fittings.  
 Design Subcooling, 16 - 19 °F @ the liquid access fitting connection ARI 95 test conditions. Design Superheat 8 - 12°F @ the compressor suction access fitting connection.  
 Shaded area reflects ACCA (TVA) conditions  
 W = Total system power  
 Amps: Unit amps (comp.+ evaporator + condenser fan motors)

IDB Airflow		Outdoor Ambient Temperature																							
		65				75				85				95				105				115			
		59	63	67	71	59	63	67	71	59	63	67	71	59	63	67	71	59	63	67	71	59	63	67	71
1200	Capacity	47,618	48,293	49,722	51,904	47,190	47,865	49,294	51,476	45,941	46,617	48,045	50,227	43,793	44,469	45,897	48,079	41,168	41,843	43,272	45,453	38,771	39,446	40,875	43,057
	S/T	0.79	0.72	0.58	0.43	1.00	0.72	0.58	0.44	1.00	0.75	0.61	0.46	1.00	0.77	0.63	0.48	1.00	1.00	0.65	0.51	1.00	1.00	0.70	0.56
	Evap dT	27.28	25.57	22.36	19.04	27.24	25.52	22.31	18.99	27.48	25.76	22.55	19.23	27.22	25.50	22.30	18.97	26.99	25.27	22.07	18.74	28.07	26.35	23.14	19.82
	Pr Suc	121	123	126	131	129	130	134	139	135	137	140	145	141	142	146	151	146	148	151	156	153	155	158	163
	Pr Dis	253	254	255	260	293	294	296	300	335	336	338	342	380	381	383	387	429	430	432	436	481	482	484	488
TotalPower	2,820	2,818	2,812	2,836	3,134	3,132	3,127	3,151	3,485	3,483	3,477	3,501	3,865	3,862	3,857	3,881	4,289	4,286	4,281	4,305	4,786	4,784	4,779	4,803	
80	Capacity	48,721	49,396	50,825	53,007	48,293	48,968	50,397	52,579	47,044	47,720	49,148	51,330	44,896	45,571	47,000	49,182	42,270	42,946	44,374	46,556	39,874	40,549	41,977	44,159
	S/T	1.00	0.86	0.72	0.58	1.00	0.86	0.73	0.58	1.00	0.89	0.75	0.61	1.00	1.00	0.77	0.63	1.00	1.00	0.79	0.65	1.00	1.00	0.85	0.70
	Evap dT	25.11	23.39	20.18	16.86	25.06	23.34	20.14	16.82	25.30	23.59	20.38	17.06	25.04	23.33	20.12	16.80	24.81	23.10	19.89	16.57	25.89	24.17	20.97	17.64
	Pr Suc	125	126	129	135	132	134	137	142	139	140	143	149	144	146	149	154	150	151	154	160	156	158	161	166
	Pr Dis	257	258	260	264	297	298	300	304	339	340	342	346	384	385	387	391	433	434	436	440	485	486	488	492
TotalPower	2,854	2,852	2,847	2,871	3,169	3,166	3,161	3,185	3,519	3,517	3,512	3,536	3,899	3,897	3,891	3,915	4,323	4,321	4,315	4,339	4,821	4,818	4,813	4,837	
1800	Capacity	49,620	50,295	51,723	53,905	49,192	49,867	51,295	53,477	47,943	48,618	50,047	52,229	45,795	46,470	47,899	50,080	43,169	43,845	45,273	47,455	40,772	41,448	42,876	45,058
	S/T	1.00	0.90	0.76	0.61	1.00	0.90	0.77	0.62	1.00	0.93	0.79	0.65	1.00	1.00	0.81	0.66	1.00	1.00	0.83	0.69	1.00	1.00	0.89	0.74
	Evap dT	24.10	22.38	19.17	15.85	24.05	22.33	19.13	15.80	24.29	22.57	19.37	16.04	24.03	22.31	19.11	15.79	23.80	22.08	18.88	15.56	24.88	23.16	19.95	16.63
	Pr Suc	127	129	132	137	135	136	139	144	141	143	146	151	147	148	151	156	152	154	157	162	159	160	163	169
	Pr Dis	259	260	262	267	299	300	302	307	341	342	344	349	387	388	389	394	435	436	438	443	487	488	490	495
TotalPower	2,870	2,868	2,862	2,886	3,184	3,182	3,177	3,201	3,535	3,533	3,527	3,551	3,915	3,912	3,907	3,931	4,339	4,336	4,331	4,355	4,836	4,834	4,829	4,853	
1200	Capacity	48,424	49,099	50,528	52,710	47,996	48,671	50,100	52,281	46,747	47,423	48,851	51,033	44,599	45,274	46,703	48,885	41,973	42,649	44,077	46,259	39,577	40,252	41,680	43,862
	S/T	1.00	0.82	0.68	0.54	1.00	0.83	0.69	0.54	1.00	1.00	0.71	0.57	1.00	1.00	0.73	0.59	1.00	1.00	0.76	0.61	1.00	1.00	1.00	0.66
	Evap dT	30.66	28.94	25.73	22.41	30.61	28.89	25.68	22.36	30.85	29.13	25.93	22.60	30.59	28.87	25.67	22.35	30.36	28.64	25.44	22.12	31.44	29.72	26.51	23.19
	Pr Suc	123	125	128	133	131	132	135	141	137	139	142	147	143	144	147	153	148	150	153	158	155	156	160	165
	Pr Dis	254	255	257	261	294	295	297	301	336	337	339	343	381	382	384	388	430	431	433	437	482	483	485	489
TotalPower	2,826	2,824	2,818	2,842	3,140	3,138	3,133	3,157	3,491	3,489	3,483	3,507	3,871	3,868	3,863	3,887	4,295	4,292	4,287	4,311	4,792	4,790	4,785	4,809	
85	Capacity	49,527	50,202	51,630	53,812	49,099	49,774	51,202	53,384	47,850	48,525	49,954	52,136	45,702	46,377	47,805	49,987	43,076	43,752	45,180	47,362	40,679	41,355	42,783	44,965
	S/T	1.00	0.96	0.82	0.68	1.00	1.00	0.83	0.68	1.00	1.00	0.86	0.71	1.00	1.00	0.88	0.73	1.00	1.00	0.90	0.75	1.000	1.000	1.000	0.805
	Evap dT	28.48	26.76	23.56	20.23	28.43	26.72	23.51	20.19	28.67	26.96	23.75	20.43	28.42	26.70	23.49	20.17	28.19	26.47	23.26	19.94	29.26	27.54	24.34	21.02
	Pr Suc	127	128	131	136	134	136	139	144	141	142	145	150	146	148	151	156	152	153	156	161	158	160	163	168
	Pr Dis	258	259	261	265	298	299	301	305	340	341	343	347	385	386	388	393	434	435	437	441	486	487	489	493
TotalPower	2,860	2,858	2,853	2,877	3,175	3,172	3,167	3,191	3,525	3,523	3,518	3,542	3,905	3,903	3,897	3,921	4,329	4,327	4,321	4,345	4,827	4,824	4,819	4,843	
1800	Capacity	50,425	51,101	52,529	54,711	49,997	50,673	52,101	54,283	48,749	49,424	50,852	53,034	46,600	47,276	48,704	50,886	43,975	44,650	46,079	48,261	41,578	42,254	43,682	45,864
	S/T	1.00	1.00	0.86	0.72	1.00	1.00	0.87	0.72	1.00	1.00	0.89	0.75	1.00	1.00	0.91	0.77	1.00	1.00	1.00	0.79	1.00	1.00	1.00	0.84
	Evap dT	27.47	25.75	22.54	19.22	27.42	25.70	22.50	19.18	27.66	25.94	22.74	19.42	27.40	25.69	22.48	19.16	27.17	25.46	22.25	18.93	28.25	26.53	23.32	20.00
	Pr Suc	129	130	134	139	136	138	141	146	143	144	148	153	148	150	153	158	154	155	159	164	161	162	165	170
	Pr Dis	260	262	263	268	301	302	303	308	343	344	345	350	388	389	391	395	437	438	439	444	489	490	491	496
TotalPower	2,876	2,874	2,868	2,892	3,190	3,188	3,183	3,207	3,541	3,539	3,533	3,557	3,921	3,918	3,913	3,937	4,345	4,342	4,337	4,361	4,842	4,840	4,835	4,859	

Shaded area reflects AHRI (TVA) conditions  
 W = Total system power  
 Amps: Unit amps (comp.+ evaporator + condenser fan motors)  
 High and low pressures are measured at the liquid and suction access fittings.  
 Design Subcooling, 16 - 19 °F @ the liquid access fitting connection ARI 95 test conditions. Design Superheat 8 - 12°F @ the compressor suction access fitting connection.



IDB Airflow		Outdoor Ambient Temperature																							
		65				75				85				95				105				115			
		59	63	67	71	59	63	67	71	59	63	67	71	59	63	67	71	59	63	67	71	59	63	67	71
		Entering Indoor Wet Bulb Temperature																							
1500	Capacity	59,742	60,590	62,383	-	57,637	58,485	60,278	-	54,941	55,789	57,582	-	51,645	52,493	54,286	-	48,636	49,484	51,277	-	45,627	46,475	48,268	-
	S/T	0.56	0.48	0.35	-	0.59	0.51	0.38	-	0.61	0.53	0.40	-	0.63	0.55	0.42	-	0.65	0.57	0.44	-	0.67	0.59	0.46	-
	Evap dT	20.23	18.41	15.00	-	20.18	18.36	14.95	-	20.44	18.61	15.21	-	19.92	18.09	14.69	-	19.48	17.65	14.25	-	19.04	17.21	13.81	-
	Pr Suc	118	119	122	-	125	126	129	-	131	133	136	-	136	138	141	-	142	143	146	-	148	150	153	-
	Pr Dis	263	264	266	-	305	306	308	-	349	350	352	-	396	397	399	-	447	448	450	-	498	500	502	-
TotalPower	3,650	3,647	3,639	-	4,085	4,081	4,074	-	4,570	4,566	4,559	-	5,094	5,091	5,084	-	5,681	5,677	5,670	-	6,369	6,365	6,358	-	
70	Capacity	60,814	61,662	63,455	-	60,277	61,125	62,918	-	58,710	59,557	61,350	-	56,013	56,861	58,654	-	52,717	53,565	55,358	-	49,708	50,556	52,349	-
	S/T	0.65	0.57	0.44	-	0.65	0.58	0.45	-	0.68	0.60	0.47	-	0.70	0.62	0.49	-	0.72	0.64	0.51	-	0.74	0.66	0.53	-
	Evap dT	18.61	16.78	13.38	-	18.56	16.74	13.33	-	18.81	16.99	13.59	-	18.54	16.72	13.31	-	18.30	16.47	13.07	-	18.06	16.23	12.83	-
	Pr Suc	120	121	124	-	127	129	132	-	133	135	138	-	139	140	143	-	144	146	149	-	151	152	155	-
	Pr Dis	267	268	270	-	308	309	311	-	352	353	355	-	399	400	402	-	450	451	453	-	504	505	507	-
TotalPower	3,683	3,680	3,672	-	4,118	4,114	4,107	-	4,603	4,599	4,592	-	5,128	5,124	5,117	-	5,714	5,711	5,703	-	6,402	6,398	6,391	-	
2250	Capacity	62,764	63,611	65,405	-	62,226	63,074	64,867	-	60,659	61,507	63,300	-	57,962	58,810	60,603	-	54,666	55,514	57,307	-	51,658	52,505	54,299	-
	S/T	0.69	0.62	0.49	-	0.70	0.62	0.49	-	0.72	0.65	0.52	-	0.74	0.67	0.53	-	0.76	0.69	0.56	-	0.78	0.71	0.58	-
	Evap dT	16.95	15.12	11.72	-	16.90	15.07	11.67	-	17.15	15.33	11.93	-	16.88	15.05	11.65	-	16.63	14.81	11.41	-	16.38	14.56	11.16	-
	Pr Suc	124	125	128	-	131	133	136	-	137	139	142	-	143	144	147	-	148	149	152	-	154	156	159	-
	Pr Dis	271	272	274	-	312	314	315	-	356	357	359	-	403	404	406	-	454	455	457	-	508	509	511	-
TotalPower	3,717	3,714	3,706	-	4,152	4,148	4,141	-	4,637	4,633	4,626	-	5,161	5,158	5,151	-	5,748	5,744	5,737	-	6,436	6,432	6,425	-	
1500	Capacity	59,777	60,625	62,418	65,157	59,240	60,088	61,881	64,620	57,672	58,520	60,313	63,052	54,976	55,823	57,617	60,356	51,680	52,528	54,321	57,060	48,671	49,519	51,312	54,051
	S/T	0.68	0.61	0.48	0.34	0.69	0.61	0.48	0.34	0.71	0.64	0.51	0.37	0.73	0.66	0.53	0.39	0.75	0.68	0.55	0.41	0.77	0.70	0.57	0.43
	Evap dT	24.24	22.41	19.01	15.49	24.19	22.36	18.96	15.44	24.44	22.62	19.22	15.69	24.17	22.35	18.94	15.42	23.93	22.10	18.70	15.17	23.69	21.86	18.46	14.93
	Pr Suc	118	119	122	127	125	126	129	134	131	133	136	141	136	138	141	146	142	143	146	151	148	150	153	158
	Pr Dis	264	265	267	271	305	306	308	313	349	350	352	357	396	397	399	404	447	448	450	454	501	502	504	508
TotalPower	3,647	3,644	3,636	3,670	4,082	4,078	4,071	4,104	4,567	4,563	4,556	4,589	5,092	5,088	5,081	5,114	5,678	5,675	5,667	5,700	6,366	6,362	6,355	6,388	
75	Capacity	60,849	61,697	63,490	66,229	60,312	61,160	62,953	65,692	58,744	59,592	61,385	64,124	56,048	56,896	58,689	61,428	52,752	53,600	55,393	58,132	49,743	50,591	52,384	55,123
	S/T	0.77	0.70	0.57	0.43	0.78	0.70	0.57	0.43	0.80	0.73	0.60	0.46	0.82	0.75	0.62	0.48	0.84	0.77	0.64	0.50	0.86	0.79	0.66	0.52
	Evap dT	22.62	20.79	17.39	13.86	22.57	20.74	17.34	13.81	22.82	21.00	17.60	14.07	22.55	20.72	17.32	13.79	22.30	20.48	17.08	13.55	22.04	21.62	18.22	14.69
	Pr Suc	120	121	124	130	127	129	132	137	134	135	138	143	139	140	143	148	144	146	149	154	151	152	155	160
	Pr Dis	267	268	270	274	308	310	311	316	352	353	355	360	399	400	402	407	450	451	453	458	504	505	507	512
TotalPower	3,681	3,677	3,670	3,703	4,115	4,112	4,104	4,137	4,600	4,597	4,589	4,622	5,125	5,121	5,114	5,147	5,711	5,708	5,700	5,734	6,399	6,396	6,388	6,421	
2250	Capacity	62,799	63,646	65,440	68,179	62,261	63,109	64,902	67,641	60,694	61,542	63,335	66,074	57,997	58,845	60,638	63,377	54,701	55,549	57,342	60,081	51,693	52,540	54,334	57,073
	S/T	0.82	0.74	0.61	0.47	0.82	0.75	0.62	0.48	0.84	0.77	0.64	0.50	0.86	0.79	0.66	0.52	0.88	0.81	0.68	0.54	0.90	0.83	0.70	0.56
	Evap dT	20.95	19.13	15.73	12.20	20.90	19.08	15.68	12.15	21.16	19.34	15.93	12.41	20.88	19.06	15.66	12.13	20.64	18.82	15.41	11.89	20.40	18.58	15.17	11.65
	Pr Suc	124	125	128	133	131	133	136	141	137	139	142	147	143	144	147	152	148	149	152	157	154	156	159	164
	Pr Dis	271	272	274	279	313	314	316	320	356	357	359	364	403	405	406	411	454	455	457	462	508	509	511	516
TotalPower	3,714	3,711	3,703	3,737	4,149	4,145	4,138	4,171	4,634	4,630	4,623	4,656	5,159	5,155	5,148	5,181	5,745	5,742	5,734	5,767	6,433	6,429	6,422	6,455	

IDB: Entering Indoor Dry Bulb Temperature  
 High and low pressures are measured at the liquid and suction access fittings.  
 Design Subcooling: 16 - 19 °F @ the liquid access fitting connection ARI 95 test conditions. Design Superheat 8 - 12°F @ the compressor suction access fitting connection.

Shaded area reflects ACCA (TVA) conditions

W = Total system power

Amps: Unit amps (comp.+ evaporator + condenser fan motors)

IDB		Outdoor Ambient Temperature																																			
		65						75						85						95						105						115					
		59	63	67	71	75	79	59	63	67	71	75	79	59	63	67	71	75	79	59	63	67	71	75	79	59	63	67	71	75	79	59	63	67	71	75	79
Entering Indoor Wet Bulb Temperature																																					
IDB	Airflow	ID WB																																			
1500	Capacity	60,088	60,936	62,729	65,468	59,551	60,399	62,192	64,931	57,983	58,831	60,624	63,363	55,287	56,134	57,928	60,667	51,991	52,839	54,632	57,371	48,982	49,830	51,623	54,362												
	S/T	0.80	0.73	0.60	0.46	1.00	0.74	0.60	0.47	1.00	0.76	0.63	0.49	1.00	0.78	0.65	0.51	1.00	0.80	0.67	0.53	1.00	1.00	0.72	0.58												
	Evap dT	28.27	26.45	23.05	19.52	28.22	26.40	23.00	19.47	28.48	26.66	23.25	19.73	28.20	26.38	22.98	19.45	27.96	26.14	22.73	19.21	29.10	27.28	23.88	20.35												
	Pr Suc	118	120	123	128	125	127	130	135	141	132	133	136	141	137	138	141	146	142	144	147	152	149	150	153	158											
	Pr Dis	264	265	267	272	306	307	309	313	349	351	352	357	397	398	400	404	447	448	448	450	455	501	503	504	509											
TotalPower	3,650	3,646	3,639	3,672	4,084	4,081	4,073	4,106	4,569	4,566	4,558	4,591	5,094	5,090	5,083	5,116	5,680	5,677	5,669	5,703	6,368	6,365	6,357	6,391													
80	Capacity	61,160	62,008	63,801	66,540	60,623	61,471	63,264	66,003	59,055	59,903	61,696	64,435	56,359	57,207	59,000	61,739	53,062	53,911	55,704	58,443	50,054	50,902	52,695	55,434												
	S/T	0.89	0.82	0.69	0.55	1.00	0.83	0.69	0.56	1.00	0.85	0.72	0.58	1.00	0.87	0.74	0.60	1.00	1.00	0.76	0.62	1.00	1.00	0.81	0.67												
	Evap dT	26.65	24.83	21.42	17.90	26.60	24.78	21.37	17.85	26.86	25.03	21.63	18.10	26.58	24.76	21.36	17.83	26.34	24.52	21.11	17.59	27.48	25.66	22.25	18.73												
	Pr Suc	121	122	125	130	128	129	132	137	134	135	139	144	139	141	144	149	145	146	149	154	151	153	156	161												
	Pr Dis	267	268	270	275	309	310	312	317	353	354	356	360	400	401	403	407	450	452	453	458	505	506	508	512												
TotalPower	3,683	3,679	3,672	3,705	4,117	4,114	4,106	4,140	4,602	4,599	4,591	4,625	5,127	5,124	5,116	5,149	5,713	5,710	5,703	5,736	6,401	6,398	6,391	6,424													
2250	Capacity	63,110	63,957	65,751	68,490	62,572	63,420	65,213	67,952	61,005	61,853	63,646	66,385	58,308	59,156	60,949	63,688	55,012	55,860	57,653	60,392	52,004	52,851	54,645	57,384												
	S/T	1.00	0.86	0.73	0.59	1.00	0.87	0.74	0.60	1.00	0.89	0.76	0.62	1.00	0.91	0.78	0.64	1.00	1.00	0.80	0.66	1.00	1.00	0.85	0.71												
	Evap dT	24.99	23.16	19.76	16.24	24.94	23.12	19.71	16.19	25.19	23.37	19.97	16.44	24.92	23.10	19.69	16.17	24.68	22.85	19.45	15.92	25.82	23.99	20.59	17.07												
	Pr Suc	124	126	129	134	132	133	136	141	138	139	142	147	143	145	148	153	148	150	153	158	155	156	159	165												
	Pr Dis	271	273	274	279	313	314	316	321	357	358	360	364	404	405	407	411	455	456	458	462	509	510	512	516												
TotalPower	3,717	3,713	3,706	3,739	4,151	4,148	4,140	4,173	4,636	4,633	4,625	4,658	5,161	5,157	5,150	5,183	5,747	5,744	5,736	5,770	6,435	6,432	6,424	6,458													
1500	Capacity	61,100	61,947	63,740	66,479	60,562	61,410	63,203	65,942	58,995	59,843	61,636	64,375	56,298	57,146	58,939	61,678	53,002	53,850	55,643	58,382	49,994	50,841	52,634	55,373												
	S/T	1.00	0.83	0.70	0.56	1.00	0.83	0.70	0.56	1.00	0.86	0.73	0.59	1.00	1.00	0.75	0.61	1.00	1.00	0.77	0.63	1.00	1.00	0.82	0.68												
	Evap dT	31.85	30.03	26.62	23.10	31.80	29.98	26.57	23.05	32.06	30.23	26.83	23.31	31.78	29.96	26.56	23.03	31.54	29.72	26.31	22.79	32.68	30.86	27.45	23.93												
	Pr Suc	120	121	124	129	127	129	132	137	133	135	138	143	139	140	143	148	144	145	148	153	150	152	155	160												
	Pr Dis	265	266	268	273	307	308	310	315	351	352	354	358	398	399	401	405	448	450	451	456	503	504	506	510												
TotalPower	3,658	3,654	3,647	3,680	4,092	4,089	4,082	4,115	4,577	4,574	4,566	4,600	5,102	5,099	5,091	5,125	5,689	5,685	5,678	5,711	6,376	6,373	6,366	6,399													
85	Capacity	62,172	63,019	64,813	67,552	61,634	62,482	64,275	67,014	60,067	60,915	62,708	65,447	57,370	58,218	60,011	62,750	54,074	54,922	56,715	59,454	51,066	51,913	53,707	56,446												
	S/T	1.00	0.92	0.79	0.65	1.00	0.93	0.79	0.65	1.00	1.00	0.82	0.68	1.00	1.00	0.84	0.70	1.00	1.00	0.86	0.72	1.000	1.000	0.908	0.769												
	Evap dT	30.23	28.41	25.00	21.48	30.18	28.36	24.95	21.43	30.43	28.61	25.21	21.68	30.16	28.34	24.93	21.41	29.92	28.09	24.69	21.16	31.06	29.23	25.83	22.31												
	Pr Suc	122	124	127	132	130	131	134	139	136	137	140	145	141	143	146	151	146	148	151	156	153	154	157	162												
	Pr Dis	269	270	272	276	310	311	313	318	354	355	357	362	401	402	404	409	452	453	455	459	506	507	509	513												
TotalPower	3,691	3,688	3,680	3,713	4,126	4,122	4,115	4,148	4,611	4,607	4,600	4,633	5,135	5,132	5,125	5,158	5,722	5,718	5,711	5,744	6,410	6,406	6,399	6,432													
2250	Capacity	64,121	64,969	66,762	69,501	63,584	64,431	66,225	68,964	62,016	62,864	64,657	67,396	59,320	60,167	61,960	64,699	56,024	56,872	58,665	61,404	53,015	53,863	55,656	58,395												
	S/T	1.00	0.96	0.83	0.69	1.00	0.97	0.84	0.70	1.00	1.00	0.86	0.72	1.00	1.00	0.88	0.74	1.00	1.00	0.90	0.76	1.00	1.00	0.81	0.81												
	Evap dT	28.57	26.74	23.34	19.81	28.52	26.69	23.29	19.76	28.77	26.95	23.55	20.02	28.50	26.67	23.27	19.75	28.25	26.43	23.03	19.50	29.40	27.57	24.17	20.64												
	Pr Suc	126	128	131	136	133	135	138	143	140	141	144	149	145	146	149	155	150	152	155	160	157	158	161	166												
	Pr Dis	273	274	276	280	314	316	317	322	358	359	361	366	405	406	408	413	456	457	459	463	510	511	513	518												
TotalPower	3,725	3,722	3,714	3,747	4,159	4,156	4,149	4,182	4,644	4,641	4,634	4,667	5,169	5,166	5,158	5,192	5,756	5,752	5,745	5,778	6,444	6,440	6,433	6,466													

IDB: Entering Indoor Dry Bulb Temperature  
 High and low pressures are measured at the liquid and suction access fittings.  
 Design Subcooling, 16 - 19 °F @ the liquid access fitting connection ARI 95 test conditions. Design Superheat 8 - 12° F @ the compressor suction access fitting connection.  
 Shaded area reflects AHRI (TVA) conditions  
 W = Total system power  
 Amps: Unit amps (comp.+ evaporator + condenser fan motors)



IDB	Airflow	ID WB	Outdoor Ambient Temperature																							
			65				75				85				95				105				115			
			59	63	67	71	59	63	67	71	59	63	67	71	59	63	67	71	59	63	67	71	59	63	67	71
80	1800	Capacity	70,996	71,995	74,107	77,333	70,363	71,362	73,474	76,700	69,517	69,515	71,628	74,854	65,340	66,339	68,451	71,677	61,458	62,456	64,569	67,795	57,913	58,912	61,024	64,251
		S/T	0.81	0.74	0.61	0.47	1.00	0.75	0.62	0.48	1.00	0.77	0.64	0.50	1.00	0.79	0.66	0.52	1.00	0.81	0.68	0.54	1.00	1.00	0.73	0.59
		Evap dT	27.93	26.11	22.70	19.18	27.88	26.06	22.65	19.13	28.13	26.31	22.91	19.38	27.86	26.04	22.63	19.11	27.62	25.79	22.39	18.86	28.76	26.93	23.53	20.01
		Pr Suc	118	120	123	128	126	127	130	135	132	133	136	141	137	139	142	147	142	144	147	152	149	150	153	158
		Pr Dis	272	273	275	280	315	316	318	323	360	361	363	368	408	410	412	416	461	462	464	468	516	517	519	524
		TotalPower	4,152	4,148	4,139	4,179	4,670	4,665	4,657	4,696	5,247	5,243	5,234	5,274	5,872	5,868	5,859	5,899	6,571	6,567	6,558	6,598	7,390	7,386	7,377	7,417
80	2100	Capacity	72,045	73,043	75,156	78,382	71,412	72,410	74,523	77,749	69,565	70,564	72,676	75,903	66,389	67,387	69,500	72,726	62,506	63,505	65,617	68,844	58,962	59,961	62,073	65,300
		S/T	0.88	0.81	0.68	0.54	1.00	0.81	0.68	0.55	1.00	0.84	0.71	0.57	1.00	0.86	0.73	0.59	1.00	1.00	0.75	0.61	1.00	1.00	0.80	0.66
		Evap dT	26.65	24.83	21.42	17.90	26.60	24.78	21.37	17.85	26.86	25.03	21.63	18.10	26.58	24.76	21.36	17.83	26.34	24.52	21.11	17.59	27.48	25.66	22.25	18.73
		Pr Suc	120	122	125	130	128	129	132	137	134	135	138	143	139	141	144	149	144	146	149	154	151	152	155	160
		Pr Dis	275	276	278	283	318	319	321	326	363	364	366	371	411	412	414	419	463	464	466	471	519	520	522	527
		TotalPower	4,183	4,179	4,170	4,210	4,701	4,697	4,688	4,727	5,278	5,274	5,265	5,305	5,904	5,899	5,891	5,930	6,602	6,598	6,589	6,629	7,422	7,417	7,409	7,448
85	2100	Capacity	74,929	75,928	78,040	81,267	74,296	75,295	77,407	80,634	72,450	73,449	75,561	78,787	69,273	70,272	72,384	75,611	65,391	66,390	68,502	71,728	61,847	62,845	64,958	68,184
		S/T	1.00	0.85	0.72	0.58	1.00	0.86	0.73	0.59	1.00	0.88	0.75	0.61	1.00	1.00	0.77	0.63	1.00	1.00	0.79	0.65	1.00	1.00	0.84	0.70
		Evap dT	24.68	22.86	19.45	15.93	24.63	22.81	19.40	15.88	24.88	23.06	19.66	16.13	24.61	22.79	19.38	15.86	24.37	22.54	19.14	15.61	25.51	23.68	20.28	16.76
		Pr Suc	125	127	130	135	132	134	137	142	139	140	143	148	144	145	148	154	149	151	154	159	156	157	160	165
		Pr Dis	280	281	283	288	323	324	326	331	368	369	371	376	416	418	419	424	469	470	472	476	524	525	527	532
		TotalPower	4,231	4,227	4,218	4,258	4,748	4,744	4,736	4,775	5,326	5,322	5,313	5,353	5,951	5,947	5,938	5,978	6,650	6,646	6,637	6,676	7,469	7,465	7,456	7,496
85	1800	Capacity	72,187	73,186	75,298	78,525	71,554	72,553	74,665	77,892	69,708	70,707	72,819	76,045	66,531	67,530	69,642	72,869	62,649	63,648	65,760	68,986	59,105	60,104	62,216	65,442
		S/T	1.00	0.84	0.71	0.57	1.00	0.84	0.71	0.58	1.00	0.87	0.74	0.60	1.00	1.00	0.76	0.62	1.00	1.00	0.78	0.64	1.00	1.00	0.83	0.69
		Evap dT	31.51	29.68	26.28	22.76	31.46	29.63	26.23	22.71	31.71	29.89	26.49	22.96	31.44	29.62	26.21	22.69	31.19	29.37	25.97	22.44	32.34	30.51	27.11	23.58
		Pr Suc	120	122	125	130	127	129	132	137	134	135	138	143	139	140	143	149	144	146	149	154	151	152	155	160
		Pr Dis	274	275	277	281	316	318	319	324	361	363	364	369	410	411	413	418	462	463	465	470	518	519	521	525
		TotalPower	4,162	4,158	4,149	4,189	4,679	4,675	4,667	4,706	5,257	5,253	5,244	5,284	5,882	5,878	5,869	5,909	6,581	6,577	6,568	6,607	7,400	7,396	7,387	7,427
85	2100	Capacity	73,236	74,235	76,347	79,573	72,603	73,602	75,714	78,941	70,757	71,755	73,868	77,094	67,580	68,579	70,691	73,917	63,698	64,696	66,809	70,035	60,154	61,152	63,264	66,491
		S/T	1.00	0.90	0.78	0.64	1.00	0.91	0.78	0.64	1.00	1.00	0.81	0.67	1.00	1.00	0.82	0.69	1.00	1.00	0.84	0.71	1.000	1.000	0.894	0.757
		Evap dT	30.23	28.41	25.00	21.48	30.18	28.36	24.95	21.43	30.43	28.61	25.21	21.68	30.16	28.34	24.93	21.41	29.92	28.09	24.69	21.16	31.06	29.23	25.83	22.31
		Pr Suc	122	124	127	132	129	131	134	139	136	137	140	145	141	142	145	150	146	148	151	156	153	154	157	162
		Pr Dis	276	277	279	284	319	320	322	327	364	365	367	372	412	414	415	420	465	466	468	472	520	521	523	528
		TotalPower	4,193	4,189	4,180	4,220	4,711	4,707	4,698	4,737	5,288	5,284	5,275	5,315	5,913	5,909	5,901	5,940	6,612	6,608	6,599	6,639	7,431	7,427	7,418	7,458
85	2700	Capacity	76,121	77,119	79,232	82,458	75,488	76,486	78,599	81,825	73,641	74,640	76,752	79,979	70,465	71,463	73,576	76,802	66,582	67,581	69,693	72,920	63,038	64,037	66,149	69,375
		S/T	1.00	0.95	0.82	0.68	1.00	1.00	0.82	0.69	1.00	1.00	0.85	0.71	1.00	1.00	0.87	0.73	1.00	1.00	0.89	0.75	1.00	1.00	1.00	0.80
		Evap dT	28.26	26.43	23.03	19.51	28.21	26.38	22.98	19.46	28.46	26.64	23.24	19.71	28.19	26.37	22.96	19.44	27.95	26.12	22.72	19.19	29.09	27.26	23.86	20.33
		Pr Suc	127	128	131	136	134	136	139	144	140	142	145	150	146	147	150	155	151	152	155	161	158	159	162	167
		Pr Dis	281	283	284	289	324	325	327	332	369	370	372	377	418	419	421	425	470	471	473	478	525	527	529	533
		TotalPower	4,241	4,237	4,228	4,268	4,758	4,754	4,745	4,785	5,336	5,332	5,323	5,363	5,961	5,957	5,948	5,988	6,660	6,656	6,647	6,686	7,479	7,475	7,466	7,506

IDB: Entering Indoor Dry Bulb Temperature  
 High and low pressures are measured at the liquid and suction access fittings.  
 Design Subcooling, 16 - 19 °F @ the liquid access fitting connection ARI 95 test conditions. Design Superheat 8 - 12° F @ the compressor suction access fitting connection.  
 Shaded area reflects AHRI (TVA) conditions  
 W = Total system power  
 Amps: Unit amps (comp.+ evaporator + condenser fan motors)

# Electrical Heater Data

UNIT	HEATER KIT MODEL NUMBER	KW	HEATING MINIMUM AIRFLOW	COOLING MINIMUM AIRFLOW	MAXIMUM CFM
3 TON AC STD STATIC	EH*D-*S06	5	1200	900	1500
	EH*D-*S11	10			
	EH*D-*S17	15			
3 TON AC HIGH STATIC	EH*D-*S06	5	1200	900	1500
	EH*D-*S11	10			
	EH*D-*S17	15			
4 TON AC STD STATIC	EH*D-*S06	5	1600	1200	2000
	EH*D-*S11	10			
	EH*D-*S17	15			
	EH*D-*S23	20			
4 TON AC HIGH STATIC	EH*D-*S06	5	1600	1200	2000
	EH*D-*S11	10			
	EH*D-*S17	15			
	EH*D-*S23	20			
5 TON AC STD STATIC	EH*D-*S06	5	1625	1500	2500
	EH*D-*S11	10			
	EH*D-*S17	15			
	EH*D-*S23	20			
5 TON AC HIGH STATIC	EH*D-*S06	5	1625	1500	2500
	EH*D-*S11	10			
	EH*D-*S17	15			
	EH*D-*S23	20			
6 TON AC STD STATIC	EH*D-*S06	5	2000	1800	3000
	EH*D-*S11	10			
	EH*D-*S17	15			
	EH*D-*S23	20			
	EH*D-*S32	30			
6 TON AC HIGH STATIC	EH*D-*S06	5	2400	1800	3000
	EH*D-*S11	10			
	EH*D-*S17	15			
	EH*D-*S23	20			
	EH*D-*S32	30			

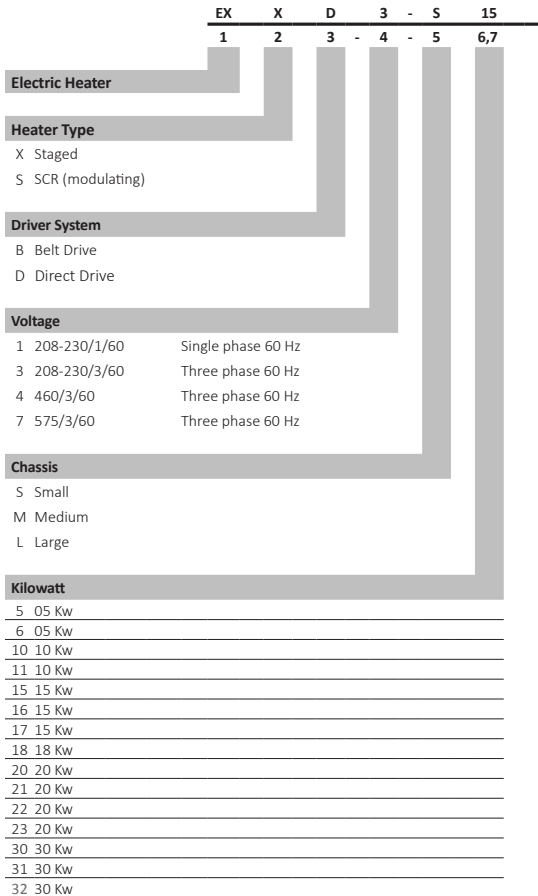

3 Ton AC - Horizontal

SPEED TAP	EXTERNAL STATIC PRESSURE (ESP) IN W. C.	STANDARD CFM	RPM	WATTS	BHP
T1	0.1	1110	505	85	0.09
	0.2	925	540	100	0.10
	0.3	850	590	115	0.11
	0.4	770	640	122	0.11
	0.5	690	695	134	0.12
	0.6	580	745	144	0.13
	0.7	515	780	149	0.14
	0.8	440	825	156	0.15
T2	0.1	1410	605	201	0.20
	0.2	1320	640	214	0.21
	0.3	1260	685	223	0.23
	0.4	1200	725	233	0.24
	0.5	1135	765	244	0.25
	0.6	1070	810	256	0.27
	0.7	1010	845	266	0.28
	0.8	950	885	278	0.29
T3	0.1	1420	610	207	0.21
	0.2	1340	645	219	0.22
	0.3	1275	685	228	0.23
	0.4	1220	730	238	0.25
	0.5	1155	770	250	0.26
	0.6	1090	810	262	0.27
	0.7	1030	850	272	0.29
	0.8	970	890	285	0.30
T4	0.1	1520	640	251	0.25
	0.2	1460	680	263	0.27
	0.3	1400	715	271	0.28
	0.4	1345	755	282	0.30
	0.5	1290	795	294	0.31
	0.6	1235	835	306	0.33
	0.7	1175	870	319	0.34
	0.8	1120	910	332	0.36
T5	0.1	1595	665	284	0.29
	0.2	1550	705	296	0.30
	0.3	1490	740	305	0.32
	0.4	1435	775	315	0.33
	0.5	1385	810	327	0.35
	0.6	1335	850	341	0.37
	0.7	1280	885	355	0.38
	0.8	1225	925	367	0.40

3 Ton AC - Downshot

SPEED TAP	EXTERNAL STATIC PRESSURE (ESP) IN W. C.	STANDARD CFM	RPM	WATTS	BHP
T1	0.1	1095	500	83	0.09
	0.2	910	535	98	0.10
	0.3	835	585	113	0.10
	0.4	760	635	120	0.11
	0.5	680	690	131	0.12
	0.6	570	740	141	0.13
	0.7	505	775	146	0.14
	0.8	435	820	153	0.15
T2	0.1	1390	600	197	0.20
	0.2	1300	635	210	0.21
	0.3	1240	680	219	0.23
	0.4	1180	720	228	0.24
	0.5	1120	760	239	0.25
	0.6	1055	805	251	0.27
	0.7	995	840	261	0.28
	0.8	935	880	273	0.29
T3	0.1	1400	605	203	0.21
	0.2	1320	640	215	0.22
	0.3	1255	680	224	0.23
	0.4	1200	725	233	0.25
	0.5	1140	765	245	0.26
	0.6	1075	805	257	0.27
	0.7	1015	845	267	0.29
	0.8	955	885	279	0.30
T4	0.1	1500	635	246	0.25
	0.2	1440	675	258	0.27
	0.3	1380	710	266	0.28
	0.4	1325	750	276	0.29
	0.5	1270	790	288	0.31
	0.6	1215	830	300	0.33
	0.7	1160	865	313	0.34
	0.8	1105	905	325	0.36
T5	0.1	1570	660	278	0.29
	0.2	1525	700	290	0.30
	0.3	1470	735	299	0.32
	0.4	1415	770	309	0.33
	0.5	1365	805	321	0.35
	0.6	1315	845	334	0.37
	0.7	1260	880	348	0.38
	0.8	1205	920	360	0.40

3 Ton AC - Horizontal

SPEED TAP	EXTERNAL STATIC PRESSURE (ESP) IN W. C.	STANDARD CFM	RPM	WATTS	BHP
T1	0.1	965	485	81	0.09
	0.2	895	545	89	0.10
	0.3	825	590	97	0.11
	0.4	785	625	104	0.11
	0.5	725	665	112	0.12
	0.6	650	715	121	0.13
	0.7	570	765	131	0.14
	0.8	495	815	141	0.15
T2	0.1	1345	610	193	0.20
	0.2	1285	650	205	0.22
	0.3	1225	695	217	0.23
	0.4	1175	730	227	0.24
	0.5	1130	765	239	0.25
	0.6	1075	800	249	0.27
	0.7	1015	840	260	0.28
	0.8	955	885	271	0.29
T3	0.1	1365	615	201	0.21
	0.2	1305	660	213	0.23
	0.3	1250	700	225	0.24
	0.4	1200	735	235	0.25
	0.5	1150	770	247	0.26
	0.6	1100	805	257	0.28
	0.7	1040	850	269	0.29
	0.8	980	890	279	0.31
T4	0.1	1465	650	239	0.28
	0.2	1410	690	252	0.30
	0.3	1355	725	265	0.31
	0.4	1305	760	276	0.33
	0.5	1260	795	288	0.34
	0.6	1205	830	299	0.36
	0.7	1155	870	311	0.38
	0.8	1105	905	322	0.39
T5	0.1	1550	675	274	0.29
	0.2	1500	715	288	0.31
	0.3	1450	750	302	0.32
	0.4	1400	785	315	0.34
	0.5	1355	820	327	0.36
	0.6	1305	860	339	0.37
	0.7	1255	890	351	0.39
	0.8	1210	925	362	0.40

3 Ton AC - Downshot

SPEED TAP	EXTERNAL STATIC PRESSURE (ESP) IN W. C.	STANDARD CFM	RPM	WATTS	BHP
T1	0.1	980	480	80	0.09
	0.2	910	535	88	0.10
	0.3	840	580	96	0.10
	0.4	795	615	102	0.11
	0.5	735	655	110	0.12
	0.6	660	705	119	0.13
	0.7	580	755	129	0.14
	0.8	500	805	139	0.15
T2	0.1	1365	600	190	0.20
	0.2	1305	640	202	0.21
	0.3	1245	685	214	0.23
	0.4	1195	720	224	0.24
	0.5	1145	755	235	0.25
	0.6	1090	790	245	0.26
	0.7	1030	830	256	0.28
	0.8	970	870	267	0.29
T3	0.1	1385	605	198	0.21
	0.2	1325	650	210	0.22
	0.3	1270	690	222	0.24
	0.4	1220	725	232	0.25
	0.5	1170	760	243	0.26
	0.6	1115	795	253	0.27
	0.7	1055	835	265	0.29
	0.8	995	875	275	0.30
T4	0.1	1485	640	235	0.28
	0.2	1430	680	248	0.29
	0.3	1375	715	261	0.31
	0.4	1325	750	272	0.32
	0.5	1280	785	284	0.34
	0.6	1225	820	295	0.36
	0.7	1175	855	306	0.37
	0.8	1120	890	317	0.39
T5	0.1	1575	665	270	0.29
	0.2	1525	705	284	0.31
	0.3	1470	740	298	0.32
	0.4	1420	775	310	0.34
	0.5	1375	810	322	0.35
	0.6	1325	845	334	0.37
	0.7	1275	875	346	0.38
	0.8	1230	910	357	0.39

4 Ton AC - Horizontal

SPEED TAP	EXTERNAL STATIC PRESSURE (ESP) IN W. C.	STANDARD CFM	RPM	WATTS	BHP
T1	0.1	1235	610	185	0.19
	0.2	1170	660	195	0.20
	0.3	1110	700	206	0.21
	0.4	1040	750	221	0.23
	0.5	970	795	231	0.24
	0.6	905	835	243	0.25
	0.7	845	880	255	0.27
	0.8	800	925	258	0.28
T2	0.1	1725	780	403	0.44
	0.2	1675	810	421	0.45
	0.3	1625	850	438	0.48
	0.4	1580	880	453	0.49
	0.5	1530	915	468	0.51
	0.6	1475	945	482	0.53
	0.7	1420	985	497	0.55
	0.8	1365	1020	516	0.57
T3	0.1	1750	785	418	0.45
	0.2	1700	820	435	0.47
	0.3	1650	855	452	0.49
	0.4	1605	885	467	0.51
	0.5	1555	920	483	0.53
	0.6	1505	950	497	0.55
	0.7	1450	990	511	0.57
	0.8	1390	1025	531	0.59
T4	0.1	1845	815	470	0.51
	0.2	1795	850	488	0.53
	0.3	1745	880	506	0.55
	0.4	1700	910	521	0.57
	0.5	1655	940	538	0.59
	0.6	1600	970	551	0.61
	0.7	1550	1010	568	0.63
	0.8	1495	1040	588	0.65
T5	0.1	1935	850	530	0.58
	0.2	1890	880	549	0.60
	0.3	1845	910	567	0.62
	0.4	1805	935	583	0.64
	0.5	1755	965	599	0.66
	0.6	1700	1000	614	0.69
	0.7	1660	1030	631	0.71
	0.8	1600	1060	653	0.73

4 Ton AC - Downshot

SPEED TAP	EXTERNAL STATIC PRESSURE (ESP) IN W. C.	STANDARD CFM	RPM	WATTS	BHP
T1	0.1	1275	585	176	0.18
	0.2	1205	635	186	0.19
	0.3	1145	675	196	0.21
	0.4	1070	720	210	0.22
	0.5	1000	765	220	0.23
	0.6	935	805	231	0.25
	0.7	870	845	243	0.26
	0.8	825	890	246	0.27
T2	0.1	1780	750	384	0.42
	0.2	1725	780	401	0.44
	0.3	1675	815	417	0.46
	0.4	1630	845	431	0.47
	0.5	1575	880	446	0.49
	0.6	1520	910	459	0.51
	0.7	1465	945	473	0.53
	0.8	1405	980	491	0.55
T3	0.1	1805	755	398	0.43
	0.2	1755	790	414	0.46
	0.3	1700	820	430	0.47
	0.4	1655	850	445	0.49
	0.5	1605	885	460	0.51
	0.6	1550	915	473	0.53
	0.7	1495	950	487	0.55
	0.8	1435	985	506	0.57
T4	0.1	1900	785	448	0.49
	0.2	1850	815	465	0.51
	0.3	1800	845	482	0.53
	0.4	1755	875	496	0.55
	0.5	1705	905	512	0.57
	0.6	1650	935	525	0.59
	0.7	1600	970	541	0.61
	0.8	1540	1000	560	0.63
T5	0.1	1995	815	505	0.56
	0.2	1950	845	523	0.58
	0.3	1900	875	540	0.60
	0.4	1860	900	555	0.62
	0.5	1810	930	570	0.64
	0.6	1755	960	585	0.66
	0.7	1710	990	601	0.68
	0.8	1650	1020	622	0.70



4 Ton AC - Horizontal

SPEED TAP	EXTERNAL STATIC PRESSURE (ESP) IN W. C.	STANDARD CFM	RPM	WATTS	BHP
T1	0.1	1250	615	179	0.19
	0.2	1195	660	191	0.20
	0.3	1130	700	202	0.21
	0.4	1050	745	214	0.23
	0.5	980	790	227	0.24
	0.6	915	830	237	0.25
	0.7	840	865	246	0.26
	0.8	775	910	258	0.28
T2	0.1	1755	780	394	0.43
	0.2	1715	810	410	0.45
	0.3	1665	845	426	0.47
	0.4	1615	875	441	0.48
	0.5	1565	910	455	0.50
	0.6	1515	940	470	0.52
	0.7	1455	980	486	0.54
	0.8	1400	1010	501	0.56
T3	0.1	1745	775	390	0.42
	0.2	1705	810	406	0.44
	0.3	1655	845	421	0.46
	0.4	1605	875	436	0.48
	0.5	1555	905	450	0.50
	0.6	1500	940	465	0.51
	0.7	1445	980	481	0.54
	0.8	1390	1010	495	0.55
T4	0.1	1840	810	443	0.49
	0.2	1800	840	459	0.50
	0.3	1750	870	476	0.52
	0.4	1710	900	490	0.54
	0.5	1660	930	506	0.56
	0.6	1610	965	520	0.58
	0.7	1560	1000	538	0.60
	0.8	1505	1030	553	0.62
T5	0.1	1925	835	493	0.54
	0.2	1880	865	510	0.56
	0.3	1835	895	526	0.58
	0.4	1795	920	542	0.60
	0.5	1750	955	557	0.62
	0.6	1705	985	573	0.64
	0.7	1655	1020	590	0.66
	0.8	1605	1045	607	0.68

4 Ton AC - Downshot

SPEED TAP	EXTERNAL STATIC PRESSURE (ESP) IN W. C.	STANDARD CFM	RPM	WATTS	BHP
T1	0.1	1265	595	174	0.18
	0.2	1205	640	185	0.19
	0.3	1140	680	196	0.21
	0.4	1060	725	208	0.22
	0.5	990	765	220	0.23
	0.6	925	805	230	0.25
	0.7	850	840	239	0.26
	0.8	785	885	250	0.27
T2	0.1	1775	755	383	0.42
	0.2	1730	785	398	0.43
	0.3	1680	820	414	0.45
	0.4	1630	850	428	0.47
	0.5	1580	885	442	0.49
	0.6	1530	915	456	0.51
	0.7	1470	950	472	0.52
	0.8	1415	980	486	0.54
T3	0.1	1765	750	379	0.41
	0.2	1720	785	394	0.43
	0.3	1670	820	409	0.45
	0.4	1620	850	423	0.47
	0.5	1570	880	437	0.48
	0.6	1515	915	451	0.50
	0.7	1460	950	467	0.52
	0.8	1405	980	481	0.54
T4	0.1	1860	785	430	0.47
	0.2	1820	815	446	0.49
	0.3	1770	845	462	0.51
	0.4	1725	875	476	0.52
	0.5	1675	905	491	0.54
	0.6	1625	935	505	0.56
	0.7	1575	970	522	0.58
	0.8	1520	1000	537	0.60
T5	0.1	1945	810	479	0.52
	0.2	1900	840	495	0.54
	0.3	1855	870	511	0.56
	0.4	1815	895	526	0.58
	0.5	1770	925	541	0.60
	0.6	1720	955	556	0.62
	0.7	1670	990	573	0.64
	0.8	1620	1015	589	0.66

5 Ton AC - Horizontal

SPEED TAP	EXTERNAL STATIC PRESSURE (ESP) IN W. C.	STANDARD CFM	RPM	WATTS	BHP
T1	0.1	1520	705	299	0.32
	0.2	1460	750	314	0.34
	0.3	1405	785	329	0.35
	0.4	1355	820	343	0.37
	0.5	1295	865	357	0.39
	0.6	1235	900	370	0.40
	0.7	1180	935	383	0.42
	0.8	1125	980	397	0.44
	0.9	1070	1015	411	0.45
	1.0	1035	1050	427	0.47
T2	0.1	1825	810	460	0.50
	0.2	1775	840	479	0.52
	0.3	1725	880	496	0.54
	0.4	1685	905	511	0.56
	0.5	1635	940	527	0.58
	0.6	1580	970	542	0.60
	0.7	1535	1005	558	0.62
	0.8	1475	1040	578	0.64
	0.9	1425	1075	599	0.67
	1.0	1375	1115	617	0.69
T3	0.1	2025	880	594	0.65
	0.2	1985	905	612	0.67
	0.3	1940	935	630	0.69
	0.4	1895	960	646	0.71
	0.5	1850	995	664	0.74
	0.6	1800	1025	679	0.76
	0.7	1755	1050	697	0.78
	0.8	1700	1080	719	0.80
	0.9	1655	1120	739	0.83
	1.0	1595	1150	759	0.85
T4	0.1	1950	855	541	0.59
	0.2	1905	885	560	0.62
	0.3	1860	915	576	0.64
	0.4	1820	940	593	0.65
	0.5	1770	970	609	0.67
	0.6	1720	1005	625	0.70
	0.7	1675	1035	642	0.72
	0.8	1620	1065	664	0.74
	0.9	1565	1100	685	0.76
	1.0	1515	1135	705	0.79
T5	0.1	2240	945	765	0.84
	0.2	2200	970	781	0.86
	0.3	2160	1000	799	0.89
	0.4	2115	1025	816	0.91
	0.5	2060	1055	834	0.93
	0.6	2020	1080	854	0.96
	0.7	1980	1110	873	0.98
	0.8	1940	1135	893	1.00
	0.9	1890	1160	907	1.03
	1.0	1840	1190	926	1.05

5 Ton AC - Downshot

SPEED TAP	EXTERNAL STATIC PRESSURE (ESP) IN W. C.	STANDARD CFM	RPM	WATTS	BHP
T1	0.1	1565	680	285	0.30
	0.2	1505	720	299	0.32
	0.3	1450	755	313	0.34
	0.4	1395	790	327	0.35
	0.5	1335	830	340	0.37
	0.6	1275	865	352	0.39
	0.7	1215	900	365	0.40
	0.8	1160	940	378	0.42
	0.9	1105	975	391	0.44
	1.0	1065	1010	407	0.45
T2	0.1	1880	780	438	0.48
	0.2	1830	810	456	0.50
	0.3	1780	845	472	0.52
	0.4	1735	870	487	0.54
	0.5	1685	905	502	0.56
	0.6	1630	935	516	0.58
	0.7	1580	965	531	0.60
	0.8	1520	1000	550	0.62
	0.9	1470	1035	570	0.64
	1.0	1415	1070	588	0.66
T3	0.1	2090	845	566	0.63
	0.2	2045	870	583	0.65
	0.3	2000	900	600	0.67
	0.4	1955	925	615	0.69
	0.5	1905	955	632	0.71
	0.6	1855	985	647	0.73
	0.7	1810	1010	664	0.75
	0.8	1755	1040	685	0.77
	0.9	1705	1075	704	0.80
	1.0	1645	1105	723	0.82
T4	0.1	2010	820	515	0.57
	0.2	1965	850	533	0.59
	0.3	1915	880	549	0.61
	0.4	1875	905	565	0.63
	0.5	1825	935	580	0.65
	0.6	1775	965	595	0.67
	0.7	1725	995	611	0.69
	0.8	1670	1025	632	0.71
	0.9	1615	1060	652	0.74
	1.0	1560	1090	671	0.76
T5	0.1	2310	910	729	0.81
	0.2	2270	935	744	0.83
	0.3	2225	960	761	0.85
	0.4	2180	985	777	0.87
	0.5	2125	1015	794	0.90
	0.6	2080	1040	813	0.92
	0.7	2040	1065	831	0.94
	0.8	2000	1090	850	0.97
	0.9	1950	1115	864	0.99
	1.0	1895	1145	882	1.01

5 Ton AC - Horizontal

SPEED TAP	EXTERNAL STATIC PRESSURE (ESP) IN W. C.	STANDARD CFM	RPM	WATTS	BHP
T1	0.1	1540	705	288	0.31
	0.2	1485	740	302	0.32
	0.3	1430	785	316	0.34
	0.4	1370	820	330	0.36
	0.5	1310	855	343	0.37
	0.6	1250	890	356	0.39
	0.7	1195	925	370	0.41
	0.8	1135	965	383	0.42
	0.9	1085	1000	396	0.44
	1.0	1040	1030	406	0.45
T2	0.1	1840	810	443	0.49
	0.2	1800	840	459	0.50
	0.3	1750	870	476	0.52
	0.4	1710	900	490	0.54
	0.5	1660	930	506	0.56
	0.6	1610	965	520	0.58
	0.7	1560	1000	538	0.60
	0.8	1505	1030	553	0.62
	0.9	1450	1060	569	0.64
	1.0	1395	1090	583	0.65
T3	0.1	2060	880	589	0.65
	0.2	2025	905	607	0.66
	0.3	1980	935	623	0.69
	0.4	1940	965	640	0.71
	0.5	1900	995	656	0.73
	0.6	1855	1020	673	0.75
	0.7	1810	1050	690	0.77
	0.8	1765	1080	707	0.79
	0.9	1715	1105	724	0.81
	1.0	1660	1140	741	0.84
T4	0.1	1970	850	524	0.60
	0.2	1930	880	541	0.62
	0.3	1885	910	558	0.64
	0.4	1845	935	574	0.66
	0.5	1800	970	589	0.68
	0.6	1755	1000	606	0.70
	0.7	1710	1030	623	0.73
	0.8	1660	1055	640	0.74
	0.9	1605	1085	655	0.76
	1.0	1550	1120	672	0.79
T5	0.1	2245	950	752	0.85
	0.2	2215	975	769	0.87
	0.3	2175	1000	787	0.89
	0.4	2135	1025	805	0.92
	0.5	2100	1050	823	0.94
	0.6	2060	1075	839	0.96
	0.7	2025	1100	857	0.98
	0.8	1985	1130	874	1.01
	0.9	1940	1155	891	1.03
	1.0	1895	1175	909	1.05

5 Ton AC - Downshot

SPEED TAP	EXTERNAL STATIC PRESSURE (ESP) IN W. C.	STANDARD CFM	RPM	WATTS	BHP
T1	0.1	1555	685	280	0.30
	0.2	1500	720	293	0.32
	0.3	1445	760	307	0.33
	0.4	1385	795	320	0.35
	0.5	1325	830	333	0.36
	0.6	1265	865	346	0.38
	0.7	1205	900	359	0.39
	0.8	1145	935	372	0.41
	0.9	1095	970	384	0.42
	1.0	1050	1000	394	0.44
T2	0.1	1860	785	430	0.47
	0.2	1820	815	446	0.49
	0.3	1770	845	462	0.51
	0.4	1725	875	476	0.52
	0.5	1675	905	491	0.54
	0.6	1625	935	505	0.56
	0.7	1575	970	522	0.58
	0.8	1520	1000	537	0.60
	0.9	1465	1030	552	0.62
	1.0	1410	1060	566	0.64
T3	0.1	2080	855	572	0.63
	0.2	2045	880	589	0.65
	0.3	2000	910	605	0.67
	0.4	1960	935	621	0.69
	0.5	1920	965	637	0.71
	0.6	1875	990	653	0.73
	0.7	1830	1020	670	0.75
	0.8	1785	1050	686	0.77
	0.9	1730	1075	703	0.79
	1.0	1675	1105	719	0.81
T4	0.1	1990	825	509	0.58
	0.2	1950	855	525	0.60
	0.3	1905	885	542	0.62
	0.4	1865	910	557	0.64
	0.5	1820	940	572	0.66
	0.6	1775	970	588	0.68
	0.7	1725	1000	605	0.70
	0.8	1675	1025	621	0.72
	0.9	1620	1055	636	0.74
	1.0	1565	1085	652	0.76
T5	0.1	2270	920	730	0.82
	0.2	2235	945	747	0.85
	0.3	2195	970	764	0.87
	0.4	2155	995	782	0.89
	0.5	2120	1020	799	0.91
	0.6	2080	1045	815	0.94
	0.7	2045	1070	832	0.96
	0.8	2005	1095	849	0.98
	0.9	1960	1120	865	1.00
	1.0	1915	1140	883	1.02

6 Ton AC - Horizontal

SPEED TAP	EXTERNAL STATIC PRESSURE (ESP) IN W. C.	STANDARD CFM	RPM	WATTS	BHP
T1	0.1	1995	790	452	0.49
	0.2	1960	815	466	0.50
	0.3	1920	845	480	0.52
	0.4	1880	870	493	0.54
	0.5	1845	900	508	0.56
	0.6	1800	930	523	0.58
	0.7	1760	965	539	0.60
	0.8	1715	995	554	0.62
T2	0.1	1405	610	197	0.20
	0.2	1350	650	208	0.22
	0.3	1300	690	220	0.23
	0.4	1240	735	232	0.24
	0.5	1180	775	245	0.26
	0.6	1120	820	259	0.27
	0.7	1065	865	270	0.29
	0.8	1005	910	284	0.30
T3	0.1	2505	960	837	0.91
	0.2	2475	980	852	0.93
	0.3	2440	1005	869	0.96
	0.4	2400	1025	886	0.98
	0.5	2365	1050	900	1.00
	0.6	2335	1070	918	1.02
	0.7	2300	1090	933	1.04
	0.8	2265	1110	949	1.06
T4	0.1	2225	865	595	0.65
	0.2	2190	890	610	0.67
	0.3	2150	910	624	0.68
	0.4	2120	935	638	0.70
	0.5	2085	960	654	0.72
	0.6	2050	985	670	0.74
	0.7	2015	1010	686	0.76
	0.8	1975	1040	701	0.78
T5	0.1	2505	960	837	0.91
	0.2	2475	980	852	0.93
	0.3	2440	1005	869	0.96
	0.4	2400	1025	886	0.98
	0.5	2365	1050	900	1.00
	0.6	2335	1070	918	1.02
	0.7	2300	1090	933	1.04
	0.8	2265	1110	949	1.06

6 Ton AC - Downshot

SPEED TAP	EXTERNAL STATIC PRESSURE (ESP) IN W. C.	STANDARD CFM	RPM	WATTS	BHP
T1	0.1	1955	800	459	0.50
	0.2	1920	825	473	0.51
	0.3	1880	855	487	0.53
	0.4	1845	880	500	0.54
	0.5	1810	910	516	0.56
	0.6	1765	940	531	0.58
	0.7	1725	975	547	0.60
	0.8	1680	1005	562	0.62
T2	0.1	1375	615	200	0.20
	0.2	1325	655	211	0.22
	0.3	1275	695	223	0.23
	0.4	1215	740	236	0.25
	0.5	1155	785	249	0.26
	0.6	1100	830	263	0.28
	0.7	1045	875	274	0.29
	0.8	985	920	288	0.31
T3	0.1	2455	970	850	0.92
	0.2	2425	990	865	0.94
	0.3	2390	1015	882	0.97
	0.4	2355	1035	899	0.99
	0.5	2320	1060	914	1.01
	0.6	2290	1080	932	1.03
	0.7	2255	1100	947	1.05
	0.8	2220	1120	963	1.07
T4	0.1	2180	875	604	0.66
	0.2	2145	900	619	0.68
	0.3	2110	920	634	0.69
	0.4	2080	945	648	0.71
	0.5	2045	970	664	0.73
	0.6	2010	995	680	0.75
	0.7	1975	1020	696	0.77
	0.8	1935	1050	712	0.79
T5	0.1	2455	970	850	0.92
	0.2	2425	990	865	0.94
	0.3	2390	1015	882	0.97
	0.4	2355	1035	899	0.99
	0.5	2320	1060	914	1.01
	0.6	2290	1080	932	1.03
	0.7	2255	1100	947	1.05
	0.8	2220	1120	963	1.07

3 Ton AC - Downshot

SPEED TAP	EXTERNAL STATIC PRESSURE (ESP) IN W. C.	STANDARD CFM	RPM	WATTS	BHP	SPEED TAP	EXTERNAL STATIC PRESSURE (ESP) IN W. C.	STANDARD CFM	RPM	WATTS	BHP
T1	0.8	1285	920	379	0.42	T1'	0.8	1500	955	474	0.53
	0.9	1235	950	391	0.43		0.9	1455	985	486	0.54
	1.0	1185	980	403	0.45		1.0	1410	1015	499	0.56
	1.1	1100	1020	416	0.47		1.1	1340	1045	514	0.58
	1.2	1050	1050	429	0.48		1.2	1290	1075	528	0.59
	1.3	1000	1085	442	0.50		1.3	1240	1105	542	0.61
	1.4	950	1115	453	0.51		1.4	1190	1135	554	0.63
	1.5	900	1145	466	0.52		1.5	1145	1165	568	0.64
	1.6	845	1180	478	0.54		1.6	1090	1195	584	0.66
	1.7	790	1205	489	0.55		1.7	1040	1225	595	0.68
1.8	750	1230	498	0.56	1.8	990	1255	609	0.69		
T2	0.8	1375	935	416	0.46	T2'	0.8	1600	975	525	0.58
	0.9	1325	965	428	0.48		0.9	1555	1000	537	0.60
	1.0	1280	995	440	0.49		1.0	1515	1030	551	0.62
	1.1	1200	1030	454	0.51		1.1	1450	1060	565	0.64
	1.2	1150	1060	468	0.52		1.2	1400	1090	580	0.65
	1.3	1100	1095	481	0.54		1.3	1355	1120	594	0.67
	1.4	1050	1120	493	0.55		1.4	1300	1145	607	0.69
	1.5	1000	1155	506	0.57		1.5	1260	1175	622	0.70
	1.6	945	1185	520	0.59		1.6	1205	1205	638	0.72
	1.7	895	1215	531	0.60		1.7	1155	1235	650	0.74
1.8	850	1240	542	0.61	1.8	1105	1265	665	0.76		
T3	0.8	1415	940	435	0.48	T3'	0.8	1635	985	545	0.61
	0.9	1370	970	447	0.50		0.9	1595	1010	558	0.63
	1.0	1325	1000	460	0.51		1.0	1555	1035	572	0.64
	1.1	1250	1035	474	0.53		1.1	1490	1065	586	0.66
	1.2	1200	1065	487	0.55		1.2	1440	1095	601	0.68
	1.3	1150	1100	501	0.57		1.3	1395	1125	615	0.70
	1.4	1095	1125	513	0.58		1.4	1345	1150	628	0.71
	1.5	1050	1155	526	0.59		1.5	1305	1180	644	0.73
	1.6	995	1190	541	0.61		1.6	1250	1210	660	0.75
	1.7	940	1215	552	0.62		1.7	1200	1235	673	0.76
1.8	895	1245	564	0.64	1.8	1150	1270	688	0.79		
T4	0.8	1500	955	474	0.53	T4'	0.8	1710	1000	587	0.66
	0.9	1455	985	486	0.54		0.9	1670	1025	600	0.67
	1.0	1410	1015	499	0.56		1.0	1630	1050	615	0.69
	1.1	1340	1045	514	0.58		1.1	1570	1075	629	0.71
	1.2	1290	1075	528	0.59		1.2	1520	1105	644	0.73
	1.3	1240	1105	542	0.61		1.3	1480	1135	659	0.75
	1.4	1190	1135	554	0.63		1.4	1425	1160	672	0.76
	1.5	1145	1165	568	0.64		1.5	1390	1185	688	0.78
	1.6	1090	1195	584	0.66		1.6	1335	1220	705	0.80
	1.7	1040	1225	595	0.68		1.7	1285	1245	718	0.82
1.8	990	1255	609	0.69	1.8	1240	1275	734	0.84		
T5	0.8	1540	965	494	0.55	T5'	0.8	1750	1010	614	0.69
	0.9	1495	990	506	0.57		0.9	1715	1030	628	0.70
	1.0	1455	1020	520	0.58		1.0	1675	1060	642	0.72
	1.1	1385	1050	534	0.60		1.1	1615	1085	656	0.74
	1.2	1335	1080	548	0.62		1.2	1570	1115	672	0.76
	1.3	1290	1110	563	0.63		1.3	1525	1140	687	0.78
	1.4	1235	1140	575	0.65		1.4	1475	1165	700	0.79
	1.5	1195	1170	589	0.67		1.5	1440	1190	716	0.81
	1.6	1135	1200	605	0.69		1.6	1390	1225	733	0.83
	1.7	1085	1230	617	0.70		1.7	1340	1250	747	0.85
1.8	1040	1260	631	0.72	1.8	1290	1280	764	0.87		

3 Ton AC - Horizontal

SPEED TAP	EXTERNAL STATIC PRESSURE (ESP) IN W. C.	STANDARD CFM	RPM	WATTS	BHP	SPEED TAP	EXTERNAL STATIC PRESSURE (ESP) IN W. C.	STANDARD CFM	RPM	WATTS	BHP
T1	0.8	1265	935	385	0.43	T1'	0.8	1480	970	481	0.54
	0.9	1215	965	397	0.44		0.9	1435	1000	493	0.55
	1.0	1165	995	409	0.45		1.0	1390	1030	506	0.57
	1.1	1085	1035	422	0.47		1.1	1320	1060	522	0.59
	1.2	1035	1065	435	0.49		1.2	1270	1090	536	0.60
	1.3	985	1100	449	0.50		1.3	1220	1120	550	0.62
	1.4	935	1130	460	0.52		1.4	1170	1150	562	0.63
	1.5	885	1160	473	0.53		1.5	1130	1180	577	0.65
	1.6	830	1200	485	0.55		1.6	1075	1215	593	0.67
1.7	780	1225	496	0.56	1.7	1025	1245	604	0.69		
1.8	740	1250	505	0.57	1.8	975	1275	618	0.70		
T2	0.8	1355	950	422	0.47	T2'	0.8	1575	990	533	0.59
	0.9	1305	980	434	0.49		0.9	1530	1015	545	0.61
	1.0	1260	1010	447	0.50		1.0	1490	1045	559	0.63
	1.1	1180	1045	461	0.52		1.1	1430	1075	573	0.64
	1.2	1135	1075	475	0.53		1.2	1380	1105	589	0.66
	1.3	1085	1110	488	0.55		1.3	1335	1135	603	0.68
	1.4	1035	1135	500	0.56		1.4	1280	1160	616	0.70
	1.5	985	1170	514	0.58		1.5	1240	1195	631	0.72
	1.6	930	1205	528	0.60		1.6	1185	1225	648	0.73
1.7	880	1235	539	0.61	1.7	1140	1255	660	0.75		
1.8	835	1260	550	0.62	1.8	1090	1285	675	0.77		
T3	0.8	1395	955	442	0.49	T3'	0.8	1610	1000	553	0.62
	0.9	1350	985	454	0.51		0.9	1570	1025	566	0.63
	1.0	1305	1015	467	0.52		1.0	1530	1050	581	0.65
	1.1	1230	1050	481	0.54		1.1	1470	1080	595	0.67
	1.2	1180	1080	494	0.56		1.2	1420	1110	610	0.69
	1.3	1135	1115	509	0.57		1.3	1375	1140	624	0.71
	1.4	1080	1140	521	0.59		1.4	1325	1165	637	0.72
	1.5	1035	1170	534	0.60		1.5	1285	1200	654	0.74
	1.6	980	1210	549	0.62		1.6	1230	1230	670	0.76
1.7	925	1235	560	0.63	1.7	1180	1255	683	0.78		
1.8	880	1265	572	0.65	1.8	1135	1290	698	0.80		
T4	0.8	1480	970	481	0.54	T4'	0.8	1685	1015	596	0.67
	0.9	1435	1000	493	0.55		0.9	1645	1040	609	0.68
	1.0	1390	1030	506	0.57		1.0	1605	1065	624	0.70
	1.1	1320	1060	522	0.59		1.1	1545	1090	638	0.72
	1.2	1270	1090	536	0.60		1.2	1495	1120	654	0.74
	1.3	1220	1120	550	0.62		1.3	1460	1150	669	0.76
	1.4	1170	1150	562	0.63		1.4	1405	1175	682	0.77
	1.5	1130	1180	577	0.65		1.5	1370	1205	698	0.79
	1.6	1075	1215	593	0.67		1.6	1315	1240	716	0.81
1.7	1025	1245	604	0.69	1.7	1265	1265	729	0.83		
1.8	975	1275	618	0.70	1.8	1220	1295	745	0.85		
T5	0.8	1515	980	501	0.56	T5'	0.8	1725	1025	623	0.70
	0.9	1475	1005	514	0.57		0.9	1690	1045	637	0.71
	1.0	1435	1035	528	0.59		1.0	1650	1075	652	0.73
	1.1	1365	1065	542	0.61		1.1	1590	1100	666	0.75
	1.2	1315	1095	556	0.63		1.2	1545	1130	682	0.77
	1.3	1270	1125	571	0.64		1.3	1500	1155	697	0.79
	1.4	1215	1155	584	0.66		1.4	1455	1180	710	0.80
	1.5	1175	1190	598	0.68		1.5	1420	1210	727	0.82
	1.6	1120	1220	614	0.70		1.6	1370	1245	744	0.85
1.7	1070	1250	626	0.71	1.7	1320	1270	758	0.86		
1.8	1025	1280	640	0.73	1.8	1270	1300	775	0.88		

4 Ton AC - Downshot

SPEED TAP	EXTERNAL STATIC PRESSURE (ESP) IN W. C.	STANDARD CFM	RPM	WATTS	BHP	SPEED TAP	EXTERNAL STATIC PRESSURE (ESP) IN W. C.	STANDARD CFM	RPM	WATTS	BHP
T1	0.8	1560	1005	557	0.62	T1'	0.8	1750	1040	664	0.74
	0.9	1505	1040	572	0.64		0.9	1695	1070	680	0.76
	1.0	1450	1065	587	0.66		1.0	1640	1100	697	0.79
	1.1	1390	1095	602	0.68		1.1	1580	1125	713	0.80
	1.2	1345	1125	614	0.70		1.2	1535	1155	729	0.82
	1.3	1305	1145	626	0.71		1.3	1495	1180	744	0.84
	1.4	1250	1175	642	0.73		1.4	1445	1205	760	0.86
	1.5	1205	1200	654	0.74		1.5	1400	1230	772	0.88
	1.6	1175	1220	664	0.75		1.6	1365	1250	784	0.89
	1.7	1130	1245	678	0.77		1.7	1325	1275	799	0.91
1.8	1100	1265	684	0.78	1.8	1295	1290	806	0.92		
T2	0.8	1810	1055	703	0.79	T2'	0.8	2020	1095	861	0.96
	0.9	1755	1080	719	0.81		0.9	1975	1120	877	0.98
	1.0	1705	1110	736	0.83		1.0	1935	1145	895	1.00
	1.1	1645	1135	754	0.85		1.1	1880	1170	917	1.02
	1.2	1600	1165	771	0.87		1.2	1830	1200	940	1.05
	1.3	1555	1190	787	0.89		1.3	1780	1230	959	1.08
	1.4	1505	1215	803	0.91		1.4	1730	1255	975	1.10
	1.5	1465	1240	815	0.93		1.5	1690	1275	988	1.12
	1.6	1425	1260	828	0.94		1.6	1645	1295	1006	1.13
	1.7	1385	1285	843	0.96		1.7	1605	1320	1020	1.16
1.8	1355	1300	851	0.97	1.8	1570	1340	1036	1.17		
T3	0.8	1825	1055	714	0.80	T3'	0.8	2035	1100	873	0.97
	0.9	1775	1085	731	0.82		0.9	1990	1125	889	1.00
	1.0	1720	1110	748	0.84		1.0	1950	1145	907	1.01
	1.1	1665	1140	766	0.86		1.1	1900	1175	930	1.04
	1.2	1620	1170	783	0.89		1.2	1845	1205	952	1.07
	1.3	1575	1195	799	0.90		1.3	1795	1230	972	1.09
	1.4	1525	1220	815	0.92		1.4	1745	1255	988	1.11
	1.5	1480	1240	827	0.94		1.5	1705	1275	1001	1.13
	1.6	1445	1260	841	0.95		1.6	1660	1300	1019	1.15
	1.7	1405	1285	856	0.97		1.7	1620	1320	1034	1.17
1.8	1375	1300	864	0.98	1.8	1585	1340	1051	1.19		
T4	0.8	1930	1075	789	0.88	T4'	0.8	2125	1120	960	1.07
	0.9	1880	1105	806	0.90		0.9	2090	1140	976	1.09
	1.0	1835	1130	823	0.93		1.0	2060	1165	994	1.11
	1.1	1780	1155	843	0.95		1.1	2015	1190	1019	1.13
	1.2	1730	1185	863	0.97		1.2	1955	1220	1045	1.16
	1.3	1685	1210	881	0.99		1.3	1895	1250	1067	1.19
	1.4	1635	1240	897	1.02		1.4	1845	1275	1083	1.21
	1.5	1595	1260	910	1.03		1.5	1805	1295	1096	1.23
	1.6	1550	1280	925	1.05		1.6	1755	1320	1117	1.26
	1.7	1510	1305	940	1.07		1.7	1715	1340	1130	1.28
1.8	1480	1320	952	1.08	1.8	1670	1365	1154	1.30		
T5	0.8	1960	1085	813	0.91	T5'	0.8	2125	1120	960	1.07
	0.9	1915	1110	829	0.93		0.9	2090	1140	976	1.09
	1.0	1865	1135	847	0.95		1.0	2060	1165	994	1.11
	1.1	1815	1160	868	0.97		1.1	2015	1190	1019	1.13
	1.2	1765	1190	889	1.00		1.2	1955	1220	1045	1.16
	1.3	1715	1220	907	1.02		1.3	1895	1250	1067	1.19
	1.4	1665	1245	923	1.04		1.4	1845	1275	1083	1.21
	1.5	1625	1265	936	1.06		1.5	1805	1295	1096	1.23
	1.6	1585	1285	952	1.08		1.6	1755	1320	1117	1.26
	1.7	1545	1310	967	1.10		1.7	1715	1340	1130	1.28
1.8	1510	1325	980	1.11	1.8	1670	1365	1154	1.30		

4 Ton AC - Horizontal

SPEED TAP	EXTERNAL STATIC PRESSURE (ESP) IN W. C.	STANDARD CFM	RPM	WATTS	BHP	SPEED TAP	EXTERNAL STATIC PRESSURE (ESP) IN W. C.	STANDARD CFM	RPM	WATTS	BHP
T1	0.8	1545	1035	574	0.64	T1'	0.8	1735	1070	684	0.76
	0.9	1490	1070	589	0.66		0.9	1680	1100	700	0.79
	1.0	1435	1095	605	0.68		1.0	1625	1135	718	0.81
	1.1	1375	1130	620	0.70		1.1	1565	1160	734	0.83
	1.2	1330	1160	632	0.72		1.2	1520	1190	751	0.85
	1.3	1290	1180	645	0.73		1.3	1480	1215	766	0.87
	1.4	1240	1210	661	0.75		1.4	1430	1240	783	0.89
	1.5	1195	1235	674	0.76		1.5	1385	1265	795	0.90
	1.6	1165	1255	684	0.78		1.6	1350	1290	808	0.92
1.7	1120	1280	698	0.79	1.7	1310	1315	823	0.94		
1.8	1090	1305	705	0.81	1.8	1280	1330	830	0.95		
T2	0.8	1790	1085	724	0.81	T2'	0.8	2000	1130	887	0.99
	0.9	1735	1110	741	0.83		0.9	1955	1155	903	1.01
	1.0	1690	1145	758	0.86		1.0	1915	1180	922	1.03
	1.1	1630	1170	777	0.87		1.1	1860	1205	945	1.06
	1.2	1585	1200	794	0.90		1.2	1810	1235	968	1.08
	1.3	1540	1225	811	0.92		1.3	1760	1265	988	1.11
	1.4	1490	1250	827	0.93		1.4	1715	1295	1004	1.13
	1.5	1450	1275	839	0.95		1.5	1675	1315	1018	1.15
	1.6	1410	1300	853	0.97		1.6	1630	1335	1036	1.17
1.7	1370	1325	868	0.99	1.7	1590	1360	1051	1.19		
1.8	1340	1340	877	1.00	1.8	1555	1380	1067	1.21		
T3	0.8	1805	1085	735	0.82	T3'	0.8	2015	1135	899	1.00
	0.9	1755	1120	753	0.85		0.9	1970	1160	916	1.03
	1.0	1705	1145	770	0.87		1.0	1930	1180	934	1.04
	1.1	1650	1175	789	0.89		1.1	1880	1210	958	1.07
	1.2	1605	1205	806	0.91		1.2	1825	1240	981	1.10
	1.3	1560	1230	823	0.93		1.3	1775	1265	1001	1.12
	1.4	1510	1255	839	0.95		1.4	1730	1295	1018	1.15
	1.5	1465	1275	852	0.96		1.5	1690	1315	1031	1.16
	1.6	1430	1300	866	0.98		1.6	1645	1340	1050	1.19
1.7	1390	1325	882	1.00	1.7	1605	1360	1065	1.20		
1.8	1360	1340	890	1.01	1.8	1570	1380	1083	1.22		
T4	0.8	1910	1105	813	0.90	T4'	0.8	2105	1155	989	1.10
	0.9	1860	1140	830	0.93		0.9	2070	1175	1005	1.12
	1.0	1815	1165	848	0.95		1.0	2040	1200	1024	1.14
	1.1	1760	1190	868	0.97		1.1	1995	1225	1050	1.17
	1.2	1715	1220	889	1.00		1.2	1935	1255	1076	1.19
	1.3	1670	1245	907	1.02		1.3	1875	1290	1099	1.23
	1.4	1620	1275	924	1.04		1.4	1825	1315	1115	1.25
	1.5	1580	1300	937	1.06		1.5	1785	1335	1129	1.27
	1.6	1535	1320	953	1.08		1.6	1735	1360	1151	1.29
1.7	1495	1345	968	1.10	1.7	1700	1380	1164	1.31		
1.8	1465	1360	981	1.11	1.8	1655	1405	1189	1.34		
T5	0.8	1940	1120	837	0.94	T5'	0.8	2105	1155	989	1.10
	0.9	1895	1145	854	0.96		0.9	2070	1175	1005	1.12
	1.0	1845	1170	872	0.98		1.0	2040	1200	1024	1.14
	1.1	1795	1195	894	1.00		1.1	1995	1225	1050	1.17
	1.2	1745	1225	916	1.03		1.2	1935	1255	1076	1.19
	1.3	1700	1255	934	1.05		1.3	1875	1290	1099	1.23
	1.4	1650	1280	951	1.07		1.4	1825	1315	1115	1.25
	1.5	1610	1305	964	1.09		1.5	1785	1335	1129	1.27
	1.6	1570	1325	981	1.11		1.6	1735	1360	1151	1.29
1.7	1530	1350	996	1.13	1.7	1700	1380	1164	1.31		
1.8	1495	1365	1009	1.14	1.8	1655	1405	1189	1.34		



5 Ton AC - Downshot

SPEED TAP	EXTERNAL STATIC PRESSURE (ESP) IN W. C.	STANDARD CFM	RPM	WATTS	BHP	SPEED TAP	EXTERNAL STATIC PRESSURE (ESP) IN W. C.	STANDARD CFM	RPM	WATTS	BHP
T1	0.8	1780	1040	683	0.70		1.5	1855	1280	1057	1.13
	0.9	1740	1070	700	0.72		1.6	1825	1300	1075	1.14
	1.0	1700	1090	715	0.74		1.7	1785	1320	1090	1.16
	1.1	1665	1115	730	0.75		1.8	1745	1340	1106	1.18
	1.2	1625	1145	744	0.77		1.9	1715	1360	1122	1.20
	1.3	1585	1170	762	0.79		2.0	1675	1380	1137	1.21
	1.4	1545	1195	777	0.81	T4	0.8	2090	1115	933	0.98
	1.5	1510	1215	791	0.82		0.9	2060	1140	951	1.00
	1.6	1475	1240	806	0.84		1.0	2030	1165	968	1.02
	1.7	1430	1260	818	0.85		1.1	1995	1190	987	1.05
	1.8	1395	1280	832	0.86		1.2	1960	1215	1003	1.07
	1.9	1350	1305	847	0.88		1.3	1925	1235	1024	1.09
2.0	1300	1325	856	0.89	1.4	1895	1255	1042	1.10		
T2	0.8	2020	1100	871	0.92	1.5	1855	1280	1057	1.13	
	0.9	1945	1110	850	0.92	1.6	1825	1300	1075	1.14	
	1.0	1910	1135	866	0.94	1.7	1785	1320	1090	1.16	
	1.1	1875	1160	883	0.97	1.8	1745	1340	1106	1.18	
	1.2	1835	1185	898	0.99	1.9	1715	1360	1122	1.20	
	1.3	1800	1210	918	1.01	2.0	1675	1380	1137	1.21	
	1.4	1765	1235	935	1.03	T5	0.8	2200	1145	1041	1.10
	1.5	1725	1255	950	1.04		0.9	2170	1170	1059	1.12
	1.6	1690	1275	966	1.06		1.0	2140	1190	1078	1.14
	1.7	1650	1295	981	1.08		1.1	2110	1215	1097	1.16
	1.8	1615	1320	995	1.10		1.2	2075	1240	1114	1.19
	1.9	1580	1340	1011	1.12		1.3	2045	1260	1136	1.21
2.0	1540	1360	1024	1.13	1.4	2010	1280	1154	1.23		
T3	0.8	2090	1115	933	0.98	1.5	1980	1300	1172	1.25	
	0.9	2060	1140	951	1.00	1.6	1945	1325	1190	1.27	
	1.0	2030	1165	968	1.02	1.7	1905	1345	1206	1.29	
	1.1	1995	1190	987	1.05	1.8	1875	1365	1222	1.31	
	1.2	1960	1215	1003	1.07	1.9	1845	1380	1240	1.32	
	1.3	1925	1235	1024	1.09	2.0	1810	1400	1256	1.34	
	1.4	1895	1255	1042	1.10						

5 Ton AC - Downshot

SPEED TAP	EXTERNAL STATIC PRESSURE (ESP) IN W. C.	STANDARD CFM	RPM	WATTS	BHP	SPEED TAP	EXTERNAL STATIC PRESSURE (ESP) IN W. C.	STANDARD CFM	RPM	WATTS	BHP
T1'	0.8	1950	1085	812	0.85	T4'	1.5	2045	1315	1244	1.32
	0.9	1920	1105	830	0.87		1.6	2015	1340	1262	1.35
	1.0	1885	1130	846	0.89		1.7	1980	1355	1279	1.36
	1.1	1850	1155	863	0.91		1.8	1945	1375	1295	1.38
	1.2	1810	1180	878	0.93		1.9	1915	1395	1314	1.40
	1.3	1775	1205	898	0.95		2.0	1885	1415	1330	1.42
	1.4	1735	1230	915	0.97		0.8	2335	1180	1179	1.24
	1.5	1700	1250	929	0.98		0.9	2305	1205	1199	1.27
	1.6	1665	1270	946	1.00		1.0	2275	1225	1217	1.29
	1.7	1625	1290	959	1.01		1.1	2240	1250	1238	1.32
1.8	1590	1315	974	1.03	1.2	2205	1265	1256	1.33		
1.9	1550	1335	989	1.05	1.3	2175	1285	1279	1.35		
2.0	1510	1355	1002	1.06	1.4	2145	1310	1298	1.38		
T2'	0.8	2135	1130	975	1.03	1.5	2115	1330	1317	1.40	
	0.9	2105	1155	994	1.05	1.6	2085	1350	1337	1.42	
	1.0	2075	1175	1012	1.07	1.7	2045	1370	1353	1.44	
	1.1	2040	1200	1030	1.09	1.8	2015	1390	1371	1.46	
	1.2	2005	1225	1047	1.12	1.9	1985	1410	1390	1.48	
	1.3	1975	1245	1068	1.13	2.0	1955	1420	1407	1.49	
	1.4	1940	1265	1085	1.15	0.8	2530	1235	1429	1.49	
	1.5	1905	1290	1103	1.18	0.9	2500	1250	1451	1.51	
	1.6	1875	1310	1120	1.19	1.0	2470	1270	1472	1.54	
	1.7	1835	1330	1136	1.21	1.1	2445	1295	1493	1.57	
1.8	1800	1350	1151	1.23	1.2	2410	1315	1514	1.59		
1.9	1770	1370	1168	1.25	1.3	2385	1335	1538	1.61		
2.0	1730	1390	1183	1.27	1.4	2355	1355	1558	1.64		
T3	0.8	2270	1165	1109	1.17	1.5	2325	1375	1581	1.66	
	0.9	2235	1185	1128	1.19	1.6	2295	1395	1601	1.69	
	1.0	2205	1210	1147	1.22	1.7	2265	1415	1620	1.71	
	1.1	2175	1230	1166	1.24	1.8	2230	1430	1641	1.73	
	1.2	2140	1250	1183	1.26	1.9	2200	1445	1661	1.75	
	1.3	2110	1275	1207	1.28	2.0	2170	1465	1678	1.77	
	1.4	2080	1295	1225	1.30						

5 Ton AC - Horizontal

SPEED TAP	EXTERNAL STATIC PRESSURE (ESP) IN W. C.	STANDARD CFM	RPM	WATTS	BHP	SPEED TAP	EXTERNAL STATIC PRESSURE (ESP) IN W. C.	STANDARD CFM	RPM	WATTS	BHP
<b>T1</b>	0.8	1760	1070	703	0.72	<b>T4</b>	1.5	1835	1320	1089	1.16
	0.9	1725	1100	721	0.74		1.6	1805	1340	1107	1.18
	1.0	1685	1125	736	0.76		1.7	1765	1360	1123	1.20
	1.1	1650	1150	752	0.78		1.8	1730	1380	1139	1.21
	1.2	1610	1180	766	0.80		1.9	1700	1400	1156	1.23
	1.3	1570	1205	785	0.81		2.0	1660	1420	1171	1.25
	1.4	1530	1230	800	0.83		0.8	2070	1150	961	1.01
	1.5	1495	1250	815	0.84		0.9	2040	1175	980	1.03
	1.6	1460	1275	830	0.86		1.0	2010	1200	997	1.06
	1.7	1415	1300	843	0.88		1.1	1975	1225	1017	1.08
	1.8	1380	1320	857	0.89		1.2	1940	1250	1033	1.10
	1.9	1335	1345	872	0.91		1.3	1905	1270	1055	1.12
	2.0	1285	1365	882	0.92		1.4	1875	1295	1073	1.14
	<b>T2</b>	0.8	2000	1135	897		0.94	1.5	1835	1320	1089
0.9		1925	1145	875	0.95	1.6	1805	1340	1107	1.18	
1.0		1890	1170	892	0.97	1.7	1765	1360	1123	1.20	
1.1		1855	1195	910	0.99	1.8	1730	1380	1139	1.21	
1.2		1815	1220	925	1.02	1.9	1700	1400	1156	1.23	
1.3		1780	1245	946	1.04	2.0	1660	1420	1171	1.25	
1.4		1745	1270	963	1.06	0.8	2180	1180	1072	1.13	
1.5		1710	1295	978	1.08	0.9	2150	1205	1091	1.15	
1.6		1675	1315	995	1.09	1.0	2120	1225	1110	1.17	
1.7		1635	1335	1010	1.11	1.1	2090	1250	1130	1.20	
1.8		1600	1360	1025	1.13	1.2	2055	1275	1147	1.22	
1.9		1565	1380	1041	1.15	1.3	2025	1300	1170	1.25	
2.0		1525	1400	1055	1.17	1.4	1990	1320	1189	1.26	
<b>T3</b>		0.8	2070	1150	961	1.01	1.5	1960	1340	1207	1.28
	0.9	2040	1175	980	1.03	1.6	1925	1365	1226	1.31	
	1.0	2010	1200	997	1.06	1.7	1885	1385	1242	1.33	
	1.1	1975	1225	1017	1.08	1.8	1855	1405	1259	1.35	
	1.2	1940	1250	1033	1.10	1.9	1825	1420	1277	1.36	
	1.3	1905	1270	1055	1.12	2.0	1790	1440	1294	1.38	
	1.4	1875	1295	1073	1.14						

5 Ton AC - Horizontal

SPEED TAP	EXTERNAL STATIC PRESSURE (ESP) IN W. C.	STANDARD CFM	RPM	WATTS	BHP	SPEED TAP	EXTERNAL STATIC PRESSURE (ESP) IN W. C.	STANDARD CFM	RPM	WATTS	BHP	
T1'	0.8	1930	1115	836	0.88		1.5	2025	1355	1281	1.36	
	0.9	1900	1140	855	0.90		1.6	1995	1380	1300	1.39	
	1.0	1865	1165	871	0.92		1.7	1960	1395	1317	1.40	
	1.1	1830	1190	889	0.93		1.8	1925	1415	1334	1.42	
	1.2	1790	1215	904	0.95		1.9	1895	1435	1353	1.44	
	1.3	1755	1240	925	0.97		2.0	1865	1455	1370	1.46	
	1.4	1720	1265	942	0.99		T4'	0.8	2310	1215	1214	1.28
	1.5	1685	1290	957	1.01			0.9	2280	1240	1235	1.31
	1.6	1650	1310	974	1.03			1.0	2250	1260	1254	1.33
	1.7	1610	1330	988	1.04			1.1	2220	1285	1275	1.35
1.8	1575	1355	1003	1.06	1.2	2185		1305	1294	1.37		
1.9	1535	1375	1019	1.08	1.3	2155		1325	1317	1.39		
2.0	1495	1395	1032	1.10	1.4	2125		1350	1337	1.42		
T2'	0.8	2115	1165	1004	1.06	1.5		2095	1370	1357	1.44	
	0.9	2085	1190	1024	1.08	1.6		2065	1390	1377	1.46	
	1.0	2055	1210	1042	1.10	1.7		2025	1410	1394	1.48	
	1.1	2020	1235	1061	1.13	1.8	1995	1430	1412	1.51		
	1.2	1985	1260	1078	1.15	1.9	1965	1450	1432	1.53		
	1.3	1955	1280	1100	1.17	2.0	1935	1465	1449	1.54		
	1.4	1920	1305	1118	1.19	T5'	0.8	2505	1270	1472	1.54	
	1.5	1885	1330	1136	1.21		0.9	2475	1290	1495	1.56	
	1.6	1855	1350	1154	1.23		1.0	2445	1310	1516	1.58	
	1.7	1815	1370	1170	1.25		1.1	2420	1335	1538	1.61	
1.8	1780	1390	1186	1.27	1.2		2385	1355	1559	1.64		
1.9	1750	1410	1203	1.28	1.3		2360	1375	1584	1.66		
2.0	1715	1430	1219	1.30	1.4		2330	1395	1605	1.69		
T3	0.8	2245	1200	1142	1.21		1.5	2300	1415	1628	1.71	
	0.9	2215	1220	1162	1.23		1.6	2270	1435	1649	1.74	
	1.0	2185	1245	1181	1.25		1.7	2240	1455	1669	1.76	
	1.1	2155	1265	1201	1.27	1.8	2210	1475	1690	1.78		
	1.2	2120	1290	1219	1.30	1.9	2180	1490	1711	1.80		
	1.3	2090	1315	1243	1.32	2.0	2150	1500	1728	1.81		
	1.4	2060	1335	1262	1.34							

6 Ton AC - Downshot

SPEED TAP	EXTERNAL STATIC PRESSURE (ESP) IN W. C.	STANDARD CFM	RPM	WATTS	BHP	SPEED TAP	EXTERNAL STATIC PRESSURE (ESP) IN W. C.	STANDARD CFM	RPM	WATTS	BHP
T1	0.6	2115	1045	836	0.87	T1'	0.6	2280	1085	980	1.02
	0.7	2080	1070	854	0.89		0.7	2240	1110	1000	1.05
	0.8	2045	1095	872	0.91		0.8	2205	1135	1019	1.07
	0.9	1985	1120	891	0.93		0.9	2150	1160	1039	1.09
	1.0	1970	1155	896	0.96		1.0	2140	1195	1043	1.13
	1.1	1940	1170	924	0.97		1.1	2105	1205	1074	1.14
	1.2	1910	1195	944	0.99		1.2	2075	1225	1096	1.15
	1.3	1875	1215	962	1.01		1.3	2045	1250	1114	1.18
	1.4	1850	1240	982	1.03		1.4	2010	1270	1130	1.20
	1.5	1815	1265	1001	1.05		1.5	1980	1295	1149	1.22
1.6	1775	1290	1017	1.07	1.6	1945	1315	1166	1.24		
1.7	1740	1310	1037	1.09	1.7	1910	1340	1186	1.26		
1.8	1705	1335	1055	1.11	1.8	1875	1360	1205	1.28		
T2	0.6	1920	990	686	0.70	T2'	0.6	2070	1030	797	0.83
	0.7	1885	1020	703	0.72		0.7	2030	1055	815	0.85
	0.8	1845	1045	720	0.74		0.8	1995	1085	833	0.87
	0.9	1790	1075	736	0.76		0.9	1940	1110	851	0.89
	1.0	1770	1110	746	0.78		1.0	1925	1145	857	0.92
	1.1	1735	1125	769	0.80		1.1	1890	1160	884	0.93
	1.2	1700	1155	786	0.82		1.2	1855	1185	903	0.95
	1.3	1665	1180	803	0.83		1.3	1825	1205	921	0.97
	1.4	1650	1205	832	0.85		1.4	1800	1230	943	0.99
	1.5	1610	1230	850	0.87		1.5	1765	1255	961	1.01
1.6	1575	1260	866	0.89	1.6	1725	1280	977	1.03		
1.7	1535	1285	885	0.91	1.7	1690	1305	997	1.05		
1.8	1495	1310	902	0.93	1.8	1650	1330	1015	1.07		
T3	0.6	2595	1175	1332	1.38	T3'	0.6	2750	1215	1543	1.58
	0.7	2560	1195	1354	1.41		0.7	2715	1240	1567	1.62
	0.8	2525	1220	1376	1.44		0.8	2680	1260	1590	1.64
	0.9	2465	1240	1399	1.46		0.9	2620	1280	1615	1.67
	1.0	2460	1275	1406	1.50		1.0	2620	1310	1627	1.71
	1.1	2435	1280	1441	1.51		1.1	2590	1320	1661	1.72
	1.2	2405	1300	1463	1.53		1.2	2560	1335	1683	1.74
	1.3	2375	1320	1484	1.56		1.3	2530	1355	1705	1.77
	1.4	2335	1340	1498	1.58		1.4	2490	1375	1722	1.79
	1.5	2305	1360	1519	1.60		1.5	2465	1395	1745	1.82
1.6	2275	1380	1538	1.63	1.6	2430	1415	1765	1.84		
1.7	2245	1400	1559	1.65	1.7	2405	1430	1786	1.86		
1.8	2210	1420	1580	1.67	1.8	2370	1450	1809	1.89		
T4	0.6	2700	1205	1475	1.52	T4'	0.6	2820	1240	1654	1.69
	0.7	2665	1225	1499	1.55		0.7	2785	1260	1679	1.72
	0.8	2635	1245	1522	1.57		0.8	2755	1280	1703	1.75
	0.9	2570	1265	1546	1.60		0.9	2690	1300	1729	1.78
	1.0	2570	1300	1556	1.64		1.0	2690	1325	1744	1.81
	1.1	2540	1305	1590	1.65		1.1	2660	1335	1777	1.82
	1.2	2510	1325	1612	1.68		1.2	2630	1355	1799	1.85
	1.3	2480	1345	1634	1.70		1.3	2600	1375	1822	1.88
	1.4	2445	1365	1650	1.73		1.4	2565	1395	1842	1.91
	1.5	2415	1385	1672	1.75		1.5	2535	1415	1865	1.93
1.6	2380	1400	1692	1.77	1.6	2505	1430	1887	1.95		
1.7	2355	1420	1713	1.80	1.7	2480	1450	1908	1.98		
1.8	2320	1440	1735	1.82	1.8	2445	1465	1931	2.00		
T5	0.6	2690	1200	1462	1.51	T5'	0.6	2855	1250	1712	1.75
	0.7	2655	1220	1485	1.53		0.7	2820	1265	1737	1.77
	0.8	2625	1245	1508	1.56		0.8	2790	1290	1762	1.80
	0.9	2565	1265	1532	1.59		0.9	2725	1310	1787	1.83
	1.0	2560	1295	1542	1.63		1.0	2725	1335	1804	1.87
	1.1	2530	1305	1576	1.64		1.1	2695	1345	1837	1.88
	1.2	2500	1325	1598	1.67		1.2	2665	1365	1858	1.91
	1.3	2470	1340	1620	1.68		1.3	2635	1385	1882	1.94
	1.4	2435	1360	1636	1.71		1.4	2600	1405	1904	1.96
	1.5	2405	1380	1658	1.73		1.5	2575	1420	1927	1.99
1.6	2375	1400	1678	1.76	1.6	2540	1440	1949	2.01		
1.7	2345	1420	1699	1.78	1.7	2515	1460	1970	2.04		
1.8	2310	1440	1720	1.81	1.8	2480	1475	1993	2.06		

6 Ton AC - Horizontal

SPEED TAP	EXTERNAL STATIC PRESSURE (ESP) IN W. C.	STANDARD CFM	RPM	WATTS	BHP	SPEED TAP	EXTERNAL STATIC PRESSURE (ESP) IN W. C.	STANDARD CFM	RPM	WATTS	BHP
T1	0.6	2085	1080	869	0.90	T1'	0.6	2245	1125	1019	1.06
	0.7	2050	1105	888	0.92		0.7	2205	1150	1040	1.08
	0.8	2015	1135	907	0.94		0.8	2170	1175	1060	1.11
	0.9	1955	1160	927	0.97		0.9	2120	1200	1081	1.13
	1.0	1940	1195	932	0.99		1.0	2110	1235	1085	1.16
	1.1	1910	1210	961	1.01		1.1	2075	1245	1117	1.17
	1.2	1880	1235	982	1.03		1.2	2045	1270	1140	1.20
	1.3	1845	1260	1000	1.05		1.3	2015	1295	1159	1.22
	1.4	1820	1285	1021	1.07		1.4	1980	1315	1175	1.24
	1.5	1790	1310	1041	1.09		1.5	1950	1340	1195	1.26
T2	0.6	1890	1025	713	0.72	T2'	0.6	2040	1065	829	0.85
	0.7	1855	1055	731	0.75		0.7	2000	1090	848	0.87
	0.8	1815	1080	749	0.76		0.8	1965	1125	866	0.90
	0.9	1765	1115	765	0.79		0.9	1910	1150	885	0.92
	1.0	1745	1150	776	0.81		1.0	1895	1185	891	0.95
	1.1	1710	1165	800	0.82		1.1	1860	1200	919	0.96
	1.2	1675	1195	817	0.84		1.2	1825	1225	939	0.98
	1.3	1640	1220	835	0.86		1.3	1800	1245	958	1.00
	1.4	1625	1245	865	0.88		1.4	1775	1275	981	1.02
	1.5	1585	1275	884	0.90		1.5	1740	1300	999	1.04
T3	0.6	2555	1215	1385	1.43	T3'	0.6	2710	1260	1605	1.64
	0.7	2520	1235	1408	1.45		0.7	2675	1285	1630	1.68
	0.8	2485	1265	1431	1.49		0.8	2640	1305	1654	1.70
	0.9	2430	1285	1455	1.51		0.9	2580	1325	1680	1.73
	1.0	2425	1320	1462	1.56		1.0	2580	1355	1692	1.77
	1.1	2400	1325	1499	1.56		1.1	2550	1365	1727	1.78
	1.2	2370	1345	1522	1.58		1.2	2520	1380	1750	1.80
	1.3	2340	1365	1543	1.61		1.3	2490	1400	1773	1.83
	1.4	2300	1385	1558	1.63		1.4	2455	1425	1791	1.86
	1.5	2270	1410	1580	1.66		1.5	2430	1445	1815	1.88
T4	0.6	2660	1245	1534	1.57	T4'	0.6	2780	1285	1720	1.76
	0.7	2625	1270	1559	1.61		0.7	2745	1305	1746	1.78
	0.8	2595	1290	1583	1.63		0.8	2715	1325	1771	1.81
	0.9	2530	1310	1608	1.66		0.9	2650	1345	1798	1.84
	1.0	2530	1345	1618	1.70		1.0	2650	1370	1814	1.87
	1.1	2500	1350	1654	1.71		1.1	2620	1380	1848	1.89
	1.2	2470	1370	1676	1.73		1.2	2590	1400	1871	1.91
	1.3	2445	1390	1699	1.76		1.3	2560	1425	1895	1.95
	1.4	2410	1415	1716	1.79		1.4	2525	1445	1916	1.97
	1.5	2380	1435	1739	1.81		1.5	2495	1465	1940	2.00
T5	0.6	2650	1240	1520	1.56	T5'	0.6	2810	1295	1780	1.81
	0.7	2615	1265	1544	1.59		0.7	2780	1310	1806	1.83
	0.8	2585	1290	1568	1.62		0.8	2750	1335	1832	1.87
	0.9	2525	1310	1593	1.65		0.9	2685	1355	1858	1.89
	1.0	2520	1340	1604	1.68		1.0	2685	1380	1876	1.93
	1.1	2490	1350	1639	1.70		1.1	2655	1390	1910	1.94
	1.2	2465	1370	1662	1.72		1.2	2625	1415	1932	1.98
	1.3	2435	1385	1685	1.74		1.3	2595	1435	1957	2.01
	1.4	2400	1410	1701	1.77		1.4	2560	1455	1980	2.03
	1.5	2370	1430	1724	1.80		1.5	2535	1470	2004	2.06

## Static Pressure

DOWNFLOW ECONOMIZER PRESSURE DROP		
Cabinet	CFM	SP in.wg.
3 Ton	900	.03"
	1200	.05"
	1500	.08"
4 Ton	1200	.06"
	1600	.10"
	2000	.14"
5 Ton	1500	.08"
	2000	.14"
	2500	.22"
6 Ton	1800	.13"
	2400	.22"
	3000	.33"

HORIZONTAL ECONOMIZER PRESSURE DROP		
Cabinet	CFM	SP in.wg.
3 Ton	900	.06"
	1200	.11"
	1500	.16"
4 Ton	1200	.11"
	1600	.19"
	2000	.29"
5 Ton	1500	.18"
	2000	.30"
	2500	.45"
6 Ton	1800	.24"
	2400	.41"
	3000	.61"

CONCENTRIC DIFFUSER 24 X 48 WITH 16" DIA COLLAR PRESSURE DROP		
Cabinet	CFM	DIFFUSER DP
3-6 Ton	1000	0.18
	1200	0.25
	1400	0.33
	1600	0.42
	1800	0.53
	2000	0.64

CONCENTRIC DIFFUSER 24 X 48 WITH 18" DIA COLLAR PRESSURE DROP		
Cabinet	CFM	DIFFUSER DP
3-6 Ton	1000	0.14
	1200	0.20
	1400	0.26
	1600	0.33
	1800	0.41
	2000	0.50
	2400	0.68

CABINET	COLLAR DIA	AIR	STATIC PRESSURE (IN W.C) AT THESE CFM			
			1200	1600	2000	2400
3-6 Ton	16"	Supply	0.09	0.17	-	-
		Return	-	-	-	-
	18"	Supply	-	-	0.15	0.22
		Return	-	-	0.04	0.06

INDOOR COIL PRESSURE DROP		
Cabinet	CFM	DP (in W.C)
3 Ton	1160	0.06"
4 Ton	1570	0.13"
5 Ton	1820	0.16"
6 Ton	2100	0.12"

# Electrical Data

Model Number	Electrical Rating	Compressor			Outdoor Fan Motor			Indoor Fan Motor			Optional Electric Heat			Optional Powered Convenience Outlet	Optional Power Exhaust	Power Supply	
		QTY	RLA	LRA	QTY	HP	FLA	Type	HP	FLA	Part #	KW*	FLA	FLA	FLA	MCA	MOP
DFC0361D	208/230/1/60	1	16.7	79	1	0.17	0.95	Direct Drive Standard Static	0.75	5.7	-	-	-	-	-	27.5/27.5	40/40
											-	-	-	9.6/8.7	-	37.1/36.2	50/50
											-	-	-	-	1.7/1.5	29.2/29.0	40/40
											-	-	-	9.6/8.7	1.7/1.5	38.8/37.7	50/50
											-	-	-	-	-	29.7/33.2	40/40
											EH*D-1S06	3.76/5.00	18.1/20.8	9.6/8.7	-	41.7/44.0	50/50
											-	-	-	-	1.7/1.5	31.8/35.0	40/40
											-	-	-	9.6/8.7	1.7/1.5	43.8/45.9	50/50
											-	-	-	-	-	52.3/59.2	60/60
											EH*D-1S11	7.51/10.0	36.1/41.7	9.6/8.7	-	64.3/70.1	70/80
											-	-	-	-	1.7/1.5	54.4/61.1	60/70
											-	-	-	9.6/8.7	1.7/1.5	66.4/72.0	70/80
DFC0363D	208/230/3/60	1	10.4	73	1	0.17	0.95	Direct Drive Standard Static	0.75	5.7	-	-	-	-	-	19.7/19.7	30/30
											-	-	-	9.6/8.7	-	29.3/28.4	35/35
											-	-	-	-	1.7/1.5	21.4/21.2	30/30
											-	-	-	9.6/8.7	1.7/1.5	31.0/29.9	35/35
											-	-	-	-	-	20.2/22.2	30/30
											EH*D-3S06	3.76/5.00	10.4/12.0	9.6/8.7	-	32.2/33.0	35/35
											-	-	-	-	1.7/1.5	22.3/24.0	30/30
											-	-	-	9.6/8.7	1.7/1.5	34.3/34.9	35/35
											-	-	-	-	-	33.2/37.2	35/40
											EH*D-3S11	7.51/10.0	20.8/24.1	9.6/8.7	-	45.2/48.1	50/50
											-	-	-	-	1.7/1.5	35.3/39.1	40/40
											-	-	-	9.6/8.7	1.7/1.5	47.3/49.9	50/50
DFC0363W	208/230/3/60	1	10.4	73	1	0.17	0.95	Direct Drive High Static	1.2	5	-	-	-	-	-	19.0/19.0	25/25
											-	-	-	9.6/8.7	-	28.6/27.7	35/35
											-	-	-	-	1.7/1.5	20.7/20.5	25/25
											-	-	-	9.6/8.7	1.7/1.5	30.3/29.2	35/35
											-	-	-	-	-	19.3/21.3	25/25
											EH*D-3S06	3.76/5.00	10.4/12.0	9.6/8.7	-	31.3/32.2	35/35
											-	-	-	-	1.7/1.5	21.4/23.2	25/25
											-	-	-	9.6/8.7	1.7/1.5	33.4/34.0	35/35
											-	-	-	-	-	32.3/36.3	35/40
											EH*D-3S11	7.51/10.0	20.8/24.1	9.6/8.7	-	44.3/47.2	45/50
											-	-	-	-	1.7/1.5	34.4/38.2	35/40
											-	-	-	9.6/8.7	1.7/1.5	46.4/49.1	50/50
DFC0364D	460/3/60	1	5.8	38	1	0.17	0.48	Direct Drive Standard Static	1.2	2.5	-	-	-	-	-	10.2	15
											-	-	-	4.3	-	14.5	20
											-	-	-	-	0.5	10.7	15
											-	-	-	4.3	0.5	15	20
											-	-	-	-	-	10.6	15
											EH*D-4S06	5	6.01	4.3	-	16	20
											-	-	-	-	0.5	11.3	15
											-	-	-	4.3	0.5	16.6	20
											-	-	-	-	-	18.2	20
											EH*D-4S11	10	12	4.3	-	23.5	25
											-	-	-	-	0.5	18.8	20
											-	-	-	4.3	0.5	24.2	25
EH*D-4S17	15	18	-	-	25.7	30											
-	-	-	4.3	-	31.1	35											
-	-	-	-	0.5	26.3	30											
-	-	-	4.3	0.5	31.7	35											



# Electrical Data

Model Number	Electrical Rating	Compressor			Outdoor Fan Motor			Indoor Fan Motor			Optional Electric Heat			Optional Powered Convenience Outlet	Optional Power Exhaust	Power Supply	
		QTY	RLA	LRA	QTY	HP	FLA	Type	HP	FLA	Part #	KW*	FLA	FLA	FLA	MCA	MOP
DFC0364W	460/3/60	1	5.8	38	1	0.17	0.48	Direct Drive High Static	1.2	2.5	-	-	-	-	-	10.2	15
											-	-	-	4.3	-	14.5	20
											-	-	-	-	0.5	10.7	15
											-	-	-	4.3	0.5	15	20
											-	-	-	-	-	10.6	15
											EH*D-4S06	5	6.01	4.3	-	16	20
											-	-	-	-	0.5	11.3	15
											-	-	-	4.3	0.5	16.6	20
											-	-	-	-	-	18.2	20
											EH*D-4S11	10	12	4.3	-	23.5	25
											-	-	-	-	0.5	18.8	20
											-	-	-	4.3	0.5	24.2	25
-	-	-	-	-	25.7	30											
EH*D-4S17	15	18	4.3	-	31.1	35											
-	-	-	-	0.5	26.3	30											
-	-	-	4.3	0.5	31.7	35											
DFC0367D	575/3/60	1	3.8	36.5	1	0.17	0.39	Direct Drive Standard Static	1.2	2	-	-	-	-	-	7.12	15
											-	-	-	3.5	-	10.6	15
											-	-	-	-	0.6	7.72	15
											-	-	-	3.5	0.6	11.2	15
											-	-	-	-	-	8.51	15
											EH*D-7S06	5	4.81	3.5	-	12.9	15
											-	-	-	-	0.6	9.26	15
											-	-	-	3.5	0.6	13.6	15
											-	-	-	-	-	14.5	15
											EH*D-7S11	10	9.62	3.5	-	18.9	20
											-	-	-	-	0.6	15.3	20
											-	-	-	3.5	0.6	19.7	20
-	-	-	-	-	20.5	25											
EH*D-7S17	15	14.4	3.5	-	24.9	25											
-	-	-	-	0.6	21.3	25											
-	-	-	3.5	0.6	25.7	30											
DFC0367W	575/3/60	1	3.8	36.5	1	0.17	0.39	Direct Drive High Static	1.2	2	-	-	-	-	-	7.12	15
											-	-	-	3.5	-	10.6	15
											-	-	-	-	0.6	7.72	15
											-	-	-	3.5	0.6	11.2	15
											-	-	-	-	-	8.51	15
											EH*D-7S06	5	4.81	3.5	-	12.9	15
											-	-	-	-	0.6	9.26	15
											-	-	-	3.5	0.6	13.6	15
											-	-	-	-	-	14.5	15
											EH*D-7S11	10	9.62	3.5	-	18.9	20
											-	-	-	-	0.6	15.3	20
											-	-	-	3.5	0.6	19.7	20
-	-	-	-	-	20.5	25											
EH*D-7S17	15	14.4	3.5	-	24.9	25											
-	-	-	-	0.6	21.3	25											
-	-	-	3.5	0.6	25.7	30											
DFC0481D	208/230/1/60	1	19.9	109	1	0.33	2	Direct Drive Standard Static	1	6.9	-	-	-	-	-	33.7/33.7	50/50
											-	-	-	9.6/8.7	-	43.3/42.4	60/60
											-	-	-	-	1.7/1.5	35.4/35.2	50/50
											-	-	-	9.6/8.7	1.7/1.5	45.0/43.9	60/60
											-	-	-	-	-	33.7/34.7	50/50
											EH*D-1S06	3.76/5.00	18.1/20.8	9.6/8.7	-	43.3/45.5	60/60
											-	-	-	-	1.7/1.5	35.4/36.5	50/50
											-	-	-	9.6/8.7	1.7/1.5	45.3/47.4	60/60
											-	-	-	-	-	53.8/60.7	60/70
											EH*D-1S11	7.51/10.0	36.1/41.7	9.6/8.7	-	65.8/71.6	70/80
											-	-	-	-	1.7/1.5	55.9/62.6	60/70
											-	-	-	9.6/8.7	1.7/1.5	67.9/73.5	70/80
											-	-	-	-	-	76.3/86.8	80/90
											EH*D-1S17	11.3/15.0	54.2/62.5	9.6/8.7	-	88.3/97.6	90/100
											-	-	-	-	1.7/1.5	78.5/88.6	80/90
											-	-	-	9.6/8.7	1.7/1.5	90.5/99.5	100/100
											-	-	-	-	-	98.9/113	100/125
											EH*D-1S23	15.0/20.0	72.2/83.3	9.6/8.7	-	111/124	125/125
-	-	-	-	1.7/1.5	101/115	110/125											
-	-	-	9.6/8.7	1.7/1.5	113/126	125/150											

# Electrical Data

Model Number	Electrical Rating	Compressor			Outdoor Fan Motor			Indoor Fan Motor			Optional Electric Heat			Optional Powered Convenience Outlet	Optional Power Exhaust	Power Supply	
		QTY	RLA	LRA	QTY	HP	FLA	Type	HP	FLA	Part #	KW*	FLA	FLA	FLA	MCA	MOP
DFC0483D	208/230/3/60	1	13.1	83.1	1	0.33	2	Direct Drive Standard Static	1	6.9	-	-	-	-	-	25.3/25.3	35/35
											-	-	-	9.6/8.7	-	34.9/34.0	45/45
											-	-	-	-	1.7/1.5	27.0/26.8	35/35
											-	-	-	9.6/8.7	1.7/1.5	36.6/35.5	45/45
											-	-	-	-	-	25.3/25.3	35/35
											EH*D-3S06	3.76/5.00	10.4/12.0	9.6/8.7	-	34.9/34.5	45/45
											-	-	-	-	1.7/1.5	27.0/26.8	35/35
											-	-	-	9.6/8.7	1.7/1.5	36.6/36.4	45/45
											-	-	-	-	-	34.7/38.7	35/40
											EH*D-3S11	7.51/10.0	20.8/24.1	9.6/8.7	-	46.7/49.6	50/50
											-	-	-	-	1.7/1.5	36.8/40.6	40/45
											-	-	-	9.6/8.7	1.7/1.5	48.8/51.4	50/60
											-	-	-	-	-	47.7/53.7	50/60
											EH*D-3S17	11.3/15.0	31.3/36.1	9.6/8.7	-	59.7/64.6	60/70
											-	-	-	-	1.7/1.5	49.8/55.6	50/60
											-	-	-	9.6/8.7	1.7/1.5	61.8/66.5	70/70
EH*D-3S23	15.0/19.9	41.5/47.9	-	-	60.5/68.5	70/70											
-	-	-	9.6/8.7	-	72.5/79.3	80/80											
-	-	-	-	1.7/1.5	62.6/70.3	70/80											
-	-	-	9.6/8.7	1.7/1.5	74.6/81.2	80/90											
DFC0483W	208/230/3/60	1	13.1	83.1	1	0.33	2	Direct Drive High Static	1.2	5	-	-	-	-	-	23.4/23.4	35/35
											-	-	-	9.6/8.7	-	33.0/32.1	45/45
											-	-	-	-	1.7/1.5	25.1/24.9	35/35
											-	-	-	9.6/8.7	1.7/1.5	34.7/33.6	45/45
											-	-	-	-	-	23.4/23.4	35/35
											EH*D-3S06	3.76/5.00	10.4/12.0	9.6/8.7	-	33.0/32.2	45/45
											-	-	-	-	1.7/1.5	25.1/24.9	35/35
											-	-	-	9.6/8.7	1.7/1.5	34.7/34.0	45/45
											-	-	-	-	-	32.3/36.3	35/40
											EH*D-3S11	7.51/10.0	20.8/24.1	9.6/8.7	-	44.3/47.2	45/50
											-	-	-	-	1.7/1.5	34.4/38.2	35/40
											-	-	-	9.6/8.7	1.7/1.5	46.4/49.1	50/50
											-	-	-	-	-	45.3/51.4	50/60
											EH*D-3S17	11.3/15.0	31.3/36.1	9.6/8.7	-	57.3/62.2	60/70
											-	-	-	-	1.7/1.5	47.5/53.2	50/60
											-	-	-	9.6/8.7	1.7/1.5	59.5/64.1	60/70
-	-	-	-	-	58.1/66.1	60/70											
EH*D-3S23	15.0/19.9	41.5/47.9	9.6/8.7	-	70.1/77.0	80/80											
-	-	-	-	1.7/1.5	60.2/68.0	70/70											
-	-	-	9.6/8.7	1.7/1.5	72.2/78.8	80/80											
DFC0484D	460/3/60	1	6.1	41	1	0.33	0.85	Direct Drive Standard Static	1.2	2.5	-	-	-	-	-	11	15
											-	-	-	4.3	-	15.3	20
											-	-	-	-	0.5	11.5	15
											-	-	-	4.3	0.5	15.8	20
											-	-	-	-	-	11	15
											EH*D-4S06	5	6.01	4.3	-	16	20
											-	-	-	-	0.5	11.5	15
											-	-	-	4.3	0.5	16.6	20
											-	-	-	-	-	18.2	20
											EH*D-4S11	10	12	4.3	-	23.5	25
											-	-	-	-	0.5	18.8	20
											-	-	-	4.3	0.5	24.2	25
											-	-	-	-	-	25.7	30
											EH*D-4S17	15	18	4.3	-	31.1	35
											-	-	-	-	0.5	26.3	30
											-	-	-	4.3	0.5	31.7	35
-	-	-	-	-	33.2	35											
EH*D-4S23	20	24.1	4.3	-	38.6	40											
-	-	-	-	0.5	33.8	35											
-	-	-	4.3	0.5	39.2	40											

# Electrical Data

Model Number	Electrical Rating	Compressor			Outdoor Fan Motor			Indoor Fan Motor			Optional Electric Heat			Optional Powered Convenience Outlet	Optional Power Exhaust	Power Supply	
		QTY	RLA	LRA	QTY	HP	FLA	Type	HP	FLA	Part #	KW*	FLA	FLA	FLA	MCA	MOP
DFC0484W	460/3/60	1	6.1	41	1	0.33	0.85	Direct Drive High Static	1.2	2.5	-	-	-	-	-	11	15
											-	-	-	4.3	-	15.3	20
											-	-	-	-	0.5	11.5	15
											-	-	-	4.3	0.5	15.8	20
											-	-	-	-	-	11	15
											EH*D-4S06	5	6.01	4.3	-	16	20
														-	0.5	11.5	15
											-	-	-	4.3	0.5	16.6	20
											-	-	-	-	-	18.2	20
											EH*D-4S11	10	12	4.3	-	23.5	25
														-	0.5	18.8	20
											-	-	-	4.3	0.5	24.2	25
											-	-	-	-	-	25.7	30
											EH*D-4S17	15	18	4.3	-	31.1	35
-	0.5	26.3	30														
-	-	-	4.3	0.5	31.7	35											
-	-	-	-	-	33.2	35											
EH*D-4S23	20	24.1	4.3	-	38.6	40											
			-	0.5	33.8	35											
-	-	-	4.3	0.5	39.2	40											
DFC0487D	575/3/60	1	4.4	33	1	0.33	0.67	Direct Drive Standard Static	1.2	2	-	-	-	-	-	8.12	15
											-	-	-	3.5	-	11.6	15
											-	-	-	-	0.6	8.72	15
											-	-	-	3.5	0.6	12.2	15
											-	-	-	-	-	8.51	15
											EH*D-7S06	5	4.81	3.5	-	12.9	15
														-	0.6	9.26	15
											-	-	-	3.5	0.6	13.6	15
											-	-	-	-	-	14.5	15
											EH*D-7S11	10	9.62	3.5	-	18.9	20
														-	0.6	15.3	20
											-	-	-	3.5	0.6	19.7	20
											-	-	-	-	-	20.5	25
											EH*D-7S17	15	14.4	3.5	-	24.9	25
-	0.6	21.3	25														
-	-	-	3.5	0.6	25.7	30											
-	-	-	-	-	26.6	30											
EH*D-7S23	20	19.2	3.5	-	30.9	35											
			-	0.6	27.3	30											
-	-	-	3.5	0.6	31.7	35											
DFC0487W	575/3/60	1	4.4	33	1	0.33	0.67	Direct Drive High Static	1.2	2	-	-	-	-	-	8.12	15
											-	-	-	3.5	-	11.6	15
											-	-	-	-	0.6	8.72	15
											-	-	-	3.5	0.6	12.2	15
											-	-	-	-	-	8.51	15
											EH*D-7S06	5	4.81	3.5	-	12.9	15
														-	0.6	9.26	15
											-	-	-	3.5	0.6	13.6	15
											-	-	-	-	-	14.5	15
											EH*D-7S11	10	9.62	3.5	-	18.9	20
														-	0.6	15.3	20
											-	-	-	3.5	0.6	19.7	20
											-	-	-	-	-	20.5	25
											EH*D-7S17	15	14.4	3.5	-	24.9	25
-	0.6	21.3	25														
-	-	-	3.5	0.6	25.7	30											
-	-	-	-	-	26.6	30											
EH*D-7S23	20	19.2	3.5	-	30.9	35											
			-	0.6	27.3	30											
-	-	-	3.5	0.6	31.7	35											

# Electrical Data

Model Number	Electrical Rating	Compressor			Outdoor Fan Motor			Indoor Fan Motor			Optional Electric Heat			Optional Powered Convenience Outlet	Optional Power Exhaust	Power Supply	
		QTY	RLA	LRA	QTY	HP	FLA	Type	HP	FLA	Part #	KW*	FLA	FLA	FLA	MCA	MOP
DFC0601D	208/230/1/60	1	26.4	134	1	0.33	2	Direct Drive Standard Static	1	6.9	-	-	-	-	-	41.9/41.9	60/60
											-	-	-	9.6/8.7	-	51.5/50.6	70/70
											-	-	-	-	1.7/1.5	43.6/43.4	60/60
											-	-	-	9.6/8.7	1.7/1.5	53.2/52.1	70/70
											-	-	-	-	-	41.9/41.9	60/60
											EH*D-1S06	3.76/5.00	18.1/20.8	9.6/8.7	-	51.5/50.6	70/70
											-	-	-	-	1.7/1.5	43.6/43.4	60/60
											-	-	-	9.6/8.7	1.7/1.5	53.2/52.1	70/70
											-	-	-	-	-	53.8/60.7	60/70
											EH*D-1S11	7.51/10.0	36.1/41.7	9.6/8.7	-	65.8/71.6	70/80
											-	-	-	-	1.7/1.5	55.9/62.6	60/70
											-	-	-	9.6/8.7	1.7/1.5	67.9/73.5	70/80
											-	-	-	-	-	76.3/86.8	80/90
											EH*D-1S17	11.3/15.0	54.2/62.5	9.6/8.7	-	88.3/97.6	90/100
											-	-	-	-	1.7/1.5	78.5/88.6	80/90
											-	-	-	9.6/8.7	1.7/1.5	90.5/99.5	100/100
-	-	-	-	-	98.9/113	100/125											
EH*D-1S23	15.0/20.0	72.2/83.3	9.6/8.7	-	111/124	125/125											
-	-	-	-	1.7/1.5	101/115	110/125											
-	-	-	9.6/8.7	1.7/1.5	113/126	125/150											
DFC0603D	208/230/3/60	1	16	110	1	0.33	2	Direct Drive Standard Static	1	6.9	-	-	-	-	-	28.9/28.9	40/40
											-	-	-	9.6/8.7	-	38.5/37.6	50/50
											-	-	-	-	1.7/1.5	30.6/30.4	40/40
											-	-	-	9.6/8.7	1.7/1.5	40.2/39.1	50/50
											-	-	-	-	-	28.9/28.9	40/40
											EH*D-3S06	3.76/5.00	10.4/12.0	9.6/8.7	-	38.5/37.6	50/50
											-	-	-	-	1.7/1.5	30.6/30.4	40/40
											-	-	-	9.6/8.7	1.7/1.5	40.2/39.1	50/50
											-	-	-	-	-	34.7/38.7	40/40
											EH*D-3S11	7.51/10.0	20.8/24.1	9.6/8.7	-	46.7/49.6	50/50
											-	-	-	-	1.7/1.5	36.8/40.6	40/45
											-	-	-	9.6/8.7	1.7/1.5	48.8/51.4	50/60
											-	-	-	-	-	47.7/53.7	50/60
											EH*D-3S17	11.3/15.0	31.3/36.1	9.6/8.7	-	59.7/64.6	60/70
											-	-	-	-	1.7/1.5	49.8/55.6	50/60
											-	-	-	9.6/8.7	1.7/1.5	61.8/66.5	70/70
-	-	-	-	-	60.5/68.5	70/70											
EH*D-3S23	15.0/19.9	41.5/47.9	9.6/8.7	-	72.5/79.3	80/80											
-	-	-	-	1.7/1.5	62.6/70.3	70/80											
-	-	-	9.6/8.7	1.7/1.5	74.6/81.2	80/90											
DFC0603W	208/230/3/60	1	16	110	1	0.33	2	Direct Drive High Static	2.3	7.7	-	-	-	-	-	29.7/29.7	45/45
											-	-	-	9.6/8.7	-	39.3/38.4	50/50
											-	-	-	-	1.7/1.5	31.4/31.2	45/45
											-	-	-	9.6/8.7	1.7/1.5	41.0/39.9	50/50
											-	-	-	-	-	29.7/29.7	45/45
											EH*D-3S06	3.76/5.00	10.4/12.0	9.6/8.7	-	39.3/38.4	50/50
											-	-	-	-	1.7/1.5	31.4/31.2	45/45
											-	-	-	9.6/8.7	1.7/1.5	41.0/39.9	50/50
											-	-	-	-	-	35.7/39.7	45/45
											EH*D-3S11	7.51/10.0	20.8/24.1	9.6/8.7	-	47.7/50.6	50/60
											-	-	-	-	1.7/1.5	37.8/41.6	45/45
											-	-	-	9.6/8.7	1.7/1.5	49.8/52.4	50/60
											-	-	-	-	-	48.7/54.7	50/60
											EH*D-3S17	11.3/15.0	31.3/36.1	9.6/8.7	-	60.7/65.6	70/70
											-	-	-	-	1.7/1.5	50.8/56.6	60/60
											-	-	-	9.6/8.7	1.7/1.5	62.8/67.5	70/70
-	-	-	-	-	61.5/69.5	70/70											
EH*D-3S23	15.0/19.9	41.5/47.9	9.6/8.7	-	73.5/80.3	80/90											
-	-	-	-	1.7/1.5	63.6/71.3	70/80											
-	-	-	9.6/8.7	1.7/1.5	75.6/82.2	80/90											

# Electrical Data

Model Number	Electrical Rating	Compressor			Outdoor Fan Motor			Indoor Fan Motor			Optional Electric Heat			Optional Powered Convenience Outlet	Optional Power Exhaust	Power Supply		
		QTY	RLA	LRA	QTY	HP	FLA	Type	HP	FLA	Part #	KW*	FLA	FLA	FLA	MCA	MOP	
DFC0604D	460/3/60	1	7.8	52	1	0.33	0.85	Direct Drive Standard Static	1.2	2.5	-	-	-	-	-	13	20	
											-	-	-	4.3	-	17.3	25	
											-	-	-	-	0.5	13.5	20	
											-	-	-	4.3	0.5	17.8	25	
											EH*D-4S06	5	6.01	-	-	-	13	20
														4.3	-	17.3	25	
														-	0.5	13.5	20	
														4.3	0.5	17.8	25	
											EH*D-4S11	10	12	-	-	-	18.2	20
														4.3	-	23.5	25	
														-	0.5	18.8	20	
														4.3	0.5	24.2	25	
EH*D-4S17	15	18	-	-	-	25.7	30											
			4.3	-	31.1	35												
			-	0.5	26.3	30												
			4.3	0.5	31.7	35												
EH*D-4S23	20	24.1	-	-	-	33.2	35											
			4.3	-	38.6	40												
			-	0.5	33.8	35												
			4.3	0.5	39.2	40												
DFC0604W	460/3/60	1	7.8	52	1	0.33	0.85	Direct Drive High Static	2.3	4.5	-	-	-	-	-	15	20	
											-	-	-	4.3	-	19.3	25	
											-	-	-	-	0.5	15.5	20	
											-	-	-	4.3	0.5	19.8	25	
											EH*D-4S06	5	6.01	-	-	-	15	20
														4.3	-	19.3	25	
														-	0.5	15.5	20	
														4.3	0.5	19.8	25	
											EH*D-4S11	10	12	-	-	-	20.7	25
														4.3	-	26	30	
														-	0.5	21.3	25	
														4.3	0.5	26.7	30	
EH*D-4S17	15	18	-	-	-	28.2	30											
			4.3	-	33.6	35												
			-	0.5	28.8	30												
			4.3	0.5	34.2	35												
EH*D-4S23	20	24.1	-	-	-	35.7	40											
			4.3	-	41.1	45												
			-	0.5	36.3	40												
			4.3	0.5	41.7	45												
DFC0607D	575/3/60	1	5.7	38.9	1	0.33	0.67	Direct Drive Standard Static	1.2	2	-	-	-	-	-	9.8	15	
											-	-	-	3.5	-	13.3	15	
											-	-	-	-	0.6	10.4	15	
											-	-	-	3.5	0.6	13.9	15	
											EH*D-7S06	5	4.81	-	-	-	9.8	15
														3.5	-	13.3	15	
														-	0.6	10.4	15	
														3.5	0.6	13.9	15	
											EH*D-7S11	10	9.62	-	-	-	14.5	15
														3.5	-	18.9	20	
														-	0.6	15.3	20	
														3.5	0.6	19.7	20	
EH*D-7S17	15	14.4	-	-	-	20.5	25											
			3.5	-	24.9	25												
			-	0.6	21.3	25												
			3.5	0.6	25.7	30												
EH*D-7S23	20	19.2	-	-	-	26.6	30											
			3.5	-	30.9	35												
			-	0.6	27.3	30												
			3.5	0.6	31.7	35												

# Electrical Data

Model Number	Electrical Rating	Compressor			Outdoor Fan Motor			Indoor Fan Motor			Optional Electric Heat			Optional Powered Convenience Outlet	Optional Power Exhaust	Power Supply	
		QTY	RLA	LRA	QTY	HP	FLA	Type	HP	FLA	Part #	KW*	FLA	FLA	FLA	MCA	MOP
DFC0607W	575/3/60	1	5.7	38.9	1	0.33	0.67	Direct Drive High Static	2.3	3.8	-	-	-	-	-	11.6	15
											-	-	-	3.5	-	15.1	20
											-	-	-	-	0.6	12.2	15
											-	-	-	3.5	0.6	15.7	20
											-	-	-	-	-	11.6	15
											EH*D-7S06	5	4.81	3.5	-	15.1	20
											-	-	-	-	0.6	12.2	15
											-	-	-	3.5	0.6	15.9	20
											-	-	-	-	-	16.8	20
											EH*D-7S11	10	9.62	3.5	-	21.2	25
											-	-	-	-	0.6	17.5	20
											-	-	-	3.5	0.6	21.9	25
											-	-	-	-	-	22.8	25
											EH*D-7S17	15	14.4	3.5	-	27.2	30
-	-	-	-	0.6	23.5	25											
-	-	-	3.5	0.6	27.9	30											
-	-	-	-	-	28.8	30											
EH*D-7S23	20	19.2	3.5	-	33.2	35											
-	-	-	-	0.6	29.6	30											
-	-	-	3.5	0.6	33.9	35											
DFC0723D	208/230/3/60	1	17.6	136	1	0.33	2	Direct Drive Standard Static	1.2	5	-	-	-	-	-	29.0/29.0	45/45
											-	-	-	9.6/8.7	-	38.6/37.7	50/50
											-	-	-	-	1.7/1.5	30.7/30.5	45/45
											-	-	-	9.6/8.7	1.7/1.5	40.3/39.2	50/50
											-	-	-	-	-	29.0/29.0	45/45
											EH*D-3S06	3.76/5.00	10.4/12.0	9.6/8.7	-	38.6/37.7	50/50
											-	-	-	-	1.7/1.5	30.7/30.5	45/45
											-	-	-	9.6/8.7	1.7/1.5	40.3/39.2	50/50
											-	-	-	-	-	32.3/36.3	45/45
											EH*D-3S11	7.51/10.0	20.8/24.1	9.6/8.7	-	44.3/47.2	50/50
											-	-	-	-	1.7/1.5	34.4/38.2	45/45
											-	-	-	9.6/8.7	1.7/1.5	46.4/49.1	50/50
											-	-	-	-	-	45.3/51.4	50/60
											EH*D-3S17	11.3/15.0	31.3/36.1	9.6/8.7	-	57.3/62.2	60/70
											-	-	-	-	1.7/1.5	47.5/53.2	50/60
											-	-	-	9.6/8.7	1.7/1.5	59.5/64.1	60/70
											-	-	-	-	-	58.1/66.1	60/70
											EH*D-3S23	15.0/19.9	41.5/47.9	9.6/8.7	-	70.1/77.0	80/80
-	-	-	-	1.7/1.5	60.2/68.0	70/70											
-	-	-	9.6/8.7	1.7/1.5	72.2/78.8	80/80											
-	-	-	-	-	81.3/92.9	90/100											
EH*D-3S32	21.6/28.8	60.0/69.3	9.6/8.7	-	93.3/104	100/110											
-	-	-	-	1.7/1.5	83.4/94.7	90/100											
-	-	-	9.6/8.7	1.7/1.5	95.4/106	100/110											

# Electrical Data

Model Number	Electrical Rating	Compressor			Outdoor Fan Motor			Indoor Fan Motor			Optional Electric Heat			Optional Powered Convenience Outlet	Optional Power Exhaust	Power Supply	
		QTY	RLA	LRA	QTY	HP	FLA	Type	HP	FLA	Part #	KW*	FLA	FLA	FLA	MCA	MOP
DFC0723W	208/230/3/60	1	17.6	136	1	0.33	2	Direct Drive High Static	2.3	7.7	-	-	-	-	-	31.7/31.7	45/45
											-	-	-	9.6/8.7	-	41.3/40.4	50/50
											-	-	-	-	1.7/1.5	33.4/33.2	45/45
											-	-	-	9.6/8.7	1.7/1.5	43.0/41.9	50/50
											-	-	-	-	-	31.7/31.7	45/45
											EH*D-3S06	3.76/5.00	10.4/12.0	9.6/8.7	-	41.3/40.4	50/50
											-	-	-	-	1.7/1.5	33.4/33.2	45/45
											-	-	-	9.6/8.7	1.7/1.5	43.0/41.9	50/50
											-	-	-	-	-	35.7/39.7	45/45
											EH*D-3S11	7.51/10.0	20.8/24.1	9.6/8.7	-	47.7/50.6	50/60
											-	-	-	-	1.7/1.5	37.8/41.6	45/45
											-	-	-	9.6/8.7	1.7/1.5	49.8/52.4	50/60
											-	-	-	-	-	48.7/54.7	50/60
											EH*D-3S17	11.3/15.0	31.3/36.1	9.6/8.7	-	60.7/65.6	70/70
-	-	-	-	1.7/1.5	50.8/56.6	60/60											
-	-	-	9.6/8.7	1.7/1.5	62.8/67.5	70/70											
-	-	-	-	-	61.5/69.5	70/70											
EH*D-3S23	15.0/19.9	41.5/47.9	9.6/8.7	-	73.5/80.3	80/90											
-	-	-	-	1.7/1.5	63.6/71.3	70/80											
-	-	-	9.6/8.7	1.7/1.5	75.6/82.2	80/90											
-	-	-	-	-	84.7/96.2	90/100											
EH*D-3S32	21.6/28.8	60.0/69.3	9.6/8.7	-	96.7/107	100/110											
-	-	-	-	1.7/1.5	86.8/98.1	90/100											
-	-	-	9.6/8.7	1.7/1.5	98.8/109	100/110											
DFC0724D	460/3/60	1	8.5	66.1	1	0.33	0.85	Direct Drive Standard Static	1.2	2.5	-	-	-	-	-	13.9	20
											-	-	-	4.3	-	18.2	25
											-	-	-	-	0.5	14.4	20
											-	-	-	4.3	0.5	18.7	25
											-	-	-	-	-	13.9	20
											EH*D-4S06	5	6.01	4.3	-	18.2	25
											-	-	-	-	0.5	14.4	20
											-	-	-	4.3	0.5	18.7	25
											-	-	-	-	-	18.2	20
											EH*D-4S11	10	12	4.3	-	23.5	25
											-	-	-	-	0.5	18.8	20
											-	-	-	4.3	0.5	24.2	25
											-	-	-	-	-	25.7	30
											EH*D-4S17	15	18	4.3	-	31.1	35
-	-	-	-	0.5	26.3	30											
-	-	-	4.3	0.5	31.7	35											
-	-	-	-	-	33.2	35											
EH*D-4S23	20	24.1	4.3	-	38.6	40											
-	-	-	-	0.5	33.8	35											
-	-	-	4.3	0.5	39.2	40											
-	-	-	-	-	48.2	50											
EH*D-4S32	30	36.1	4.3	-	53.6	60											
-	-	-	-	0.5	48.9	50											
-	-	-	4.3	0.5	54.2	60											

# Electrical Data

Model Number	Electrical Rating	Compressor			Outdoor Fan Motor			Indoor Fan Motor			Optional Electric Heat			Optional Powered Convenience Outlet	Optional Power Exhaust	Power Supply	
		QTY	RLA	LRA	QTY	HP	FLA	Type	HP	FLA	Part #	KW*	FLA	FLA	FLA	MCA	MOP
DFC0724W	460/3/60	1	8.5	66.1	1	0.33	0.85	Direct Drive High Static	2.3	4.5	-	-	-	-	-	15.9	20
											-	-	-	4.3	-	20.2	25
											-	-	-	-	0.5	16.4	20
											-	-	-	4.3	0.5	20.7	25
											-	-	-	-	-	15.9	20
											EH*D-4S06	5	6.01	4.3	-	20.2	25
														-	0.5	16.4	20
											-	-	-	4.3	0.5	20.7	25
											EH*D-4S11	10	12	4.3	-	26	30
														-	0.5	21.3	25
											-	-	-	4.3	0.5	26.7	30
											EH*D-4S17	15	18	4.3	-	33.6	35
														-	0.5	28.8	30
											-	-	-	4.3	0.5	34.2	35
EH*D-4S23	20	24.1	4.3	-	35.7	40											
			-	0.5	41.1	45											
-	-	-	4.3	0.5	36.3	40											
EH*D-4S32	30	36.1	4.3	-	50.7	60											
			-	0.5	56.1	60											
-	-	-	4.3	0.5	51.4	60											
-	-	-	4.3	0.5	56.7	60											
DFC0727D	575/3/60	1	6.3	55.3	1	0.33	0.67	Direct Drive Standard Static	1.2	2	-	-	-	-	-	10.6	15
											-	-	-	3.5	-	14.1	20
											-	-	-	-	0.6	11.2	15
											-	-	-	3.5	0.6	14.7	20
											-	-	-	-	-	10.6	15
											EH*D-7S06	5	4.81	3.5	-	14.1	20
														-	0.6	11.2	15
											-	-	-	3.5	0.6	14.7	20
											EH*D-7S11	10	9.62	3.5	-	14.5	15
														-	0.6	18.9	20
											-	-	-	3.5	0.6	15.3	20
											EH*D-7S17	15	14.4	3.5	-	19.7	20
														-	0.6	20.5	25
											-	-	-	3.5	0.6	24.9	25
EH*D-7S23	20	19.2	3.5	-	21.3	25											
			-	0.6	25.7	30											
-	-	-	3.5	0.6	26.6	30											
EH*D-7S32	30	28.9	3.5	-	30.9	35											
			-	0.6	27.3	30											
-	-	-	3.5	0.6	31.7	35											
-	-	-	-	-	38.6	40											
-	-	-	3.5	0.6	43	45											
-	-	-	3.5	0.6	39.3	40											
-	-	-	3.5	0.6	43.7	45											
DFC0727W	575/3/60	1	6.3	55.3	1	0.33	0.67	Direct Drive High Static	2.3	3.8	-	-	-	-	-	12.4	15
											-	-	-	3.5	-	15.9	20
											-	-	-	-	0.6	13	15
											-	-	-	3.5	0.6	16.5	20
											-	-	-	-	-	12.4	15
											EH*D-7S06	5	4.81	3.5	-	15.9	20
														-	0.6	13	15
											-	-	-	3.5	0.6	16.5	20
											EH*D-7S11	10	9.62	3.5	-	16.8	20
														-	0.6	21.2	25
											-	-	-	3.5	0.6	17.5	20
											EH*D-7S17	15	14.4	3.5	-	21.9	25
														-	0.6	22.8	25
											-	-	-	3.5	0.6	27.2	30
EH*D-7S23	20	19.2	3.5	-	23.5	25											
			-	0.6	27.9	30											
-	-	-	3.5	0.6	27.9	30											
EH*D-7S32	30	28.9	3.5	-	28.8	30											
			-	0.6	33.2	35											
-	-	-	3.5	0.6	29.6	30											
-	-	-	-	-	33.9	35											
-	-	-	3.5	0.6	40.8	45											
-	-	-	3.5	0.6	45.2	50											
-	-	-	3.5	0.6	41.6	45											
-	-	-	3.5	0.6	46	50											



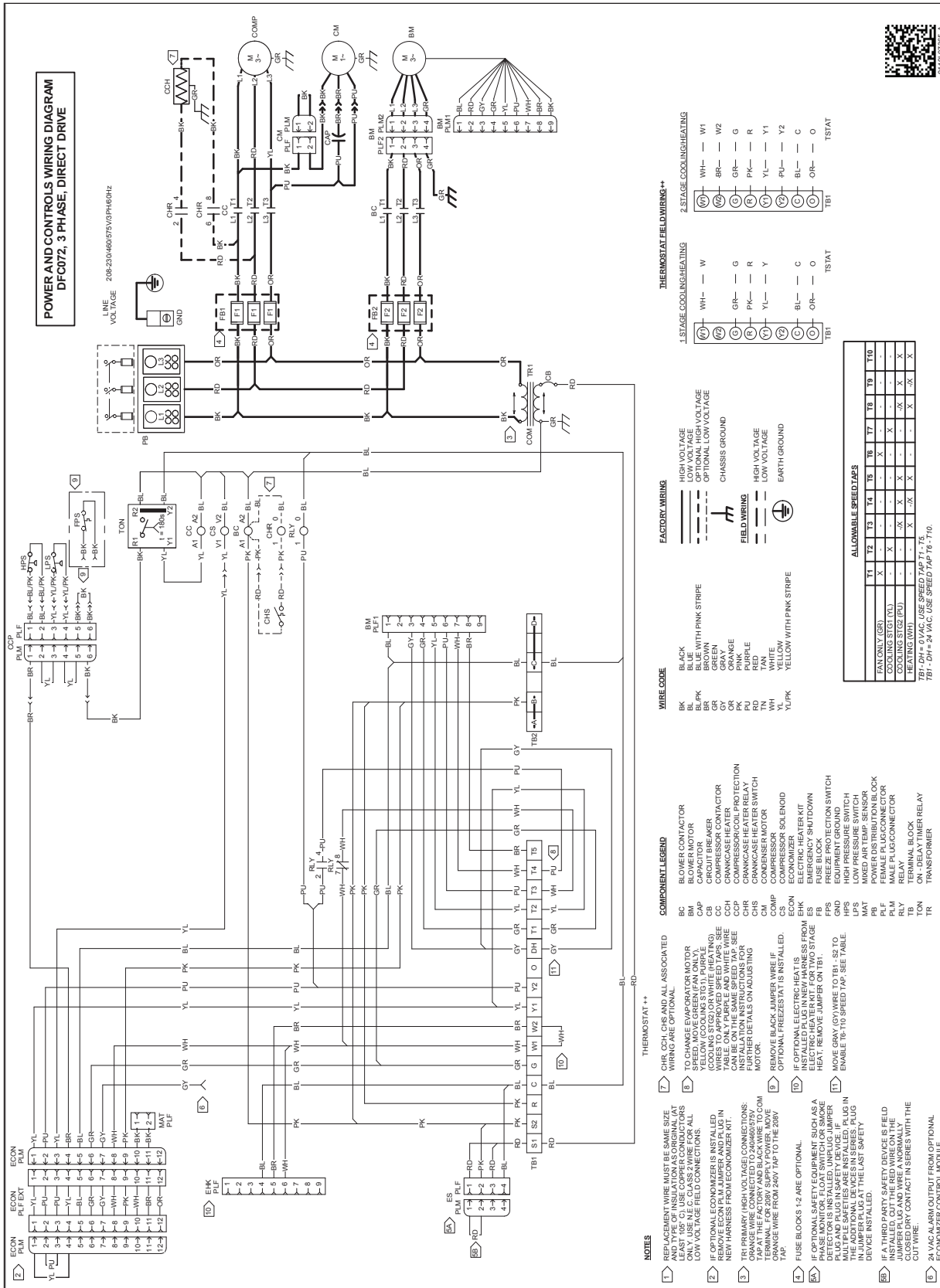

**WARNING**

High Voltage: Disconnect all power before servicing or installing this unit. Multiple power sources may be present. Failure to do so may cause property damage, personal injury, or death.

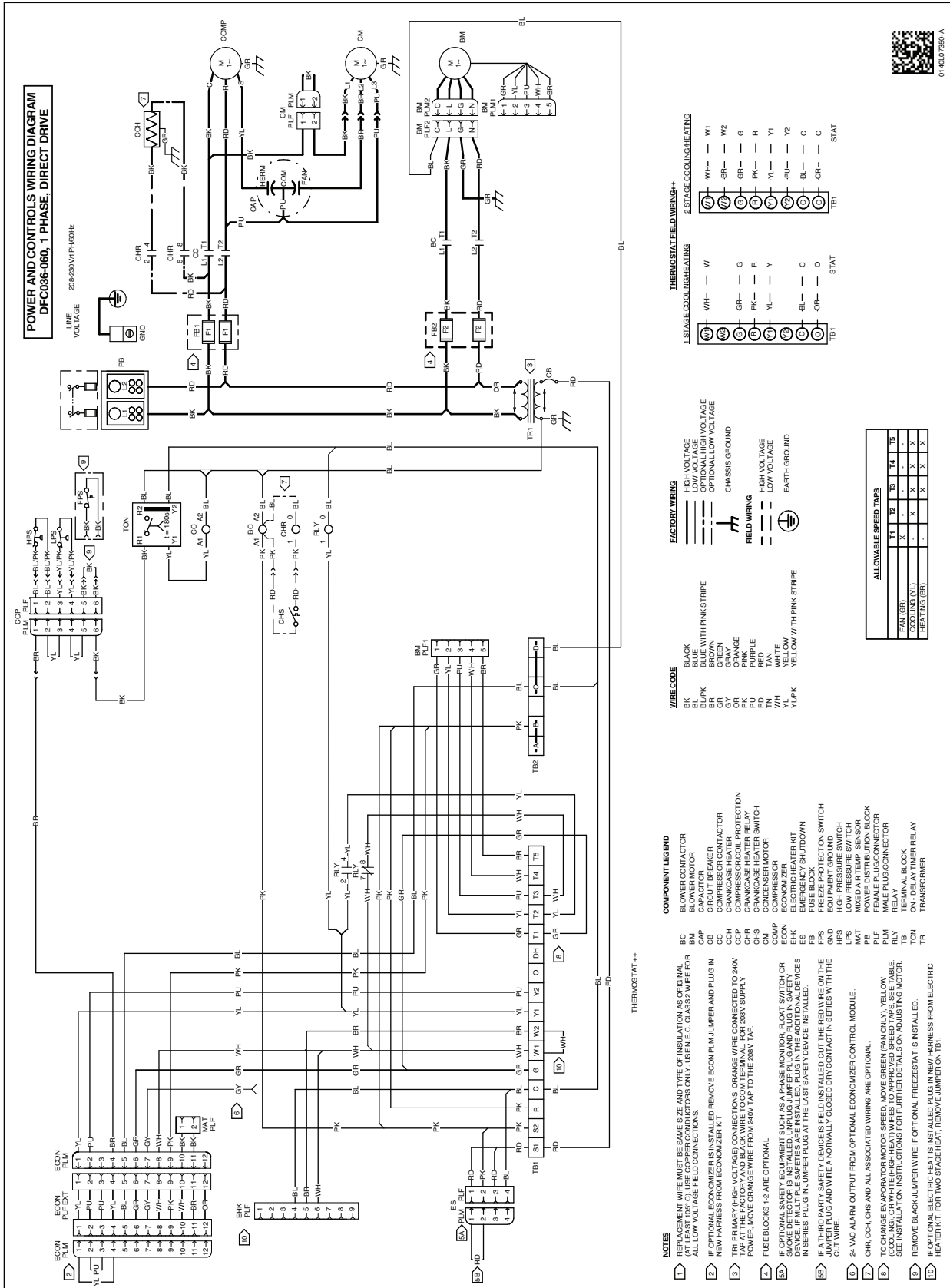

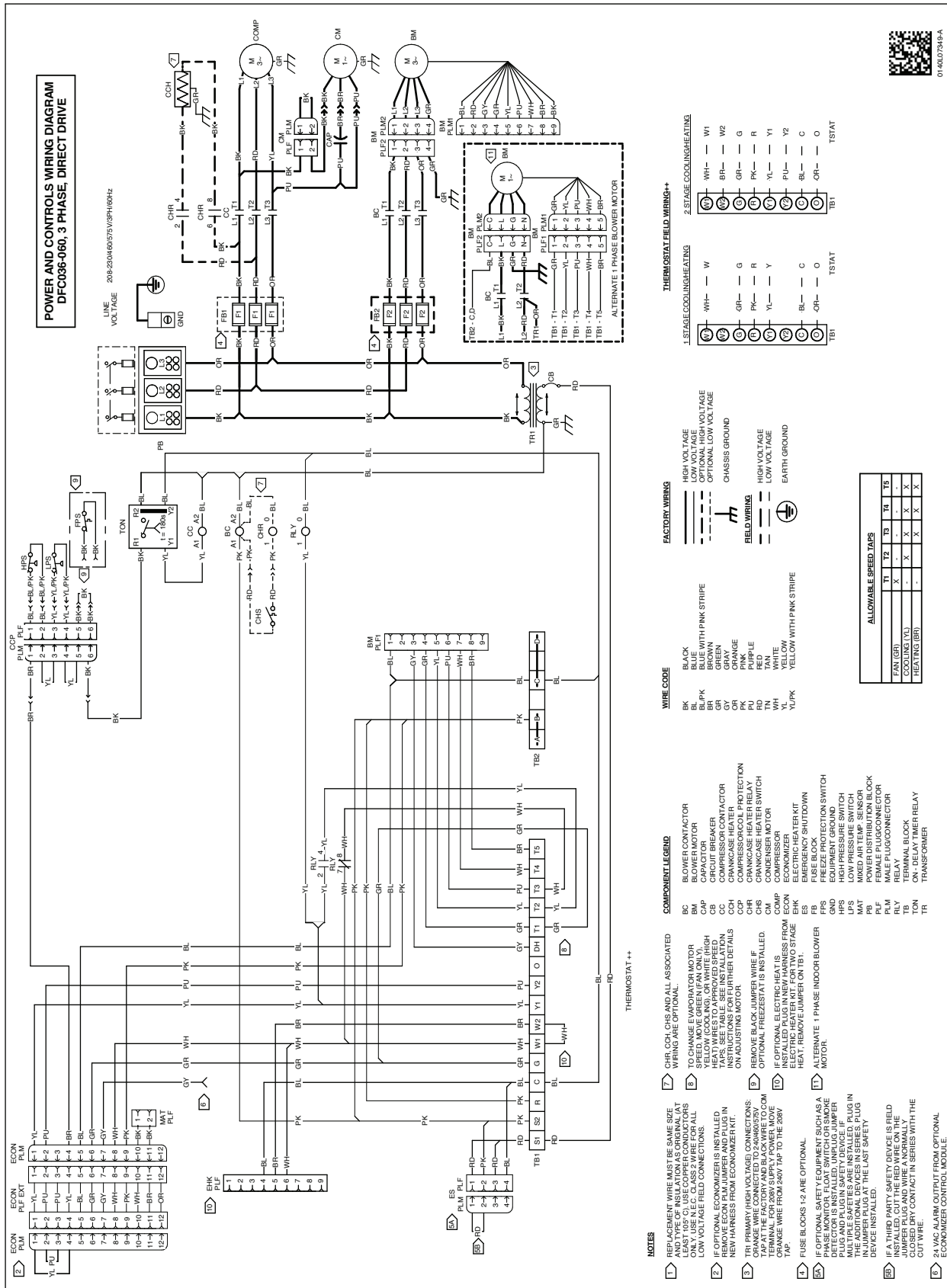

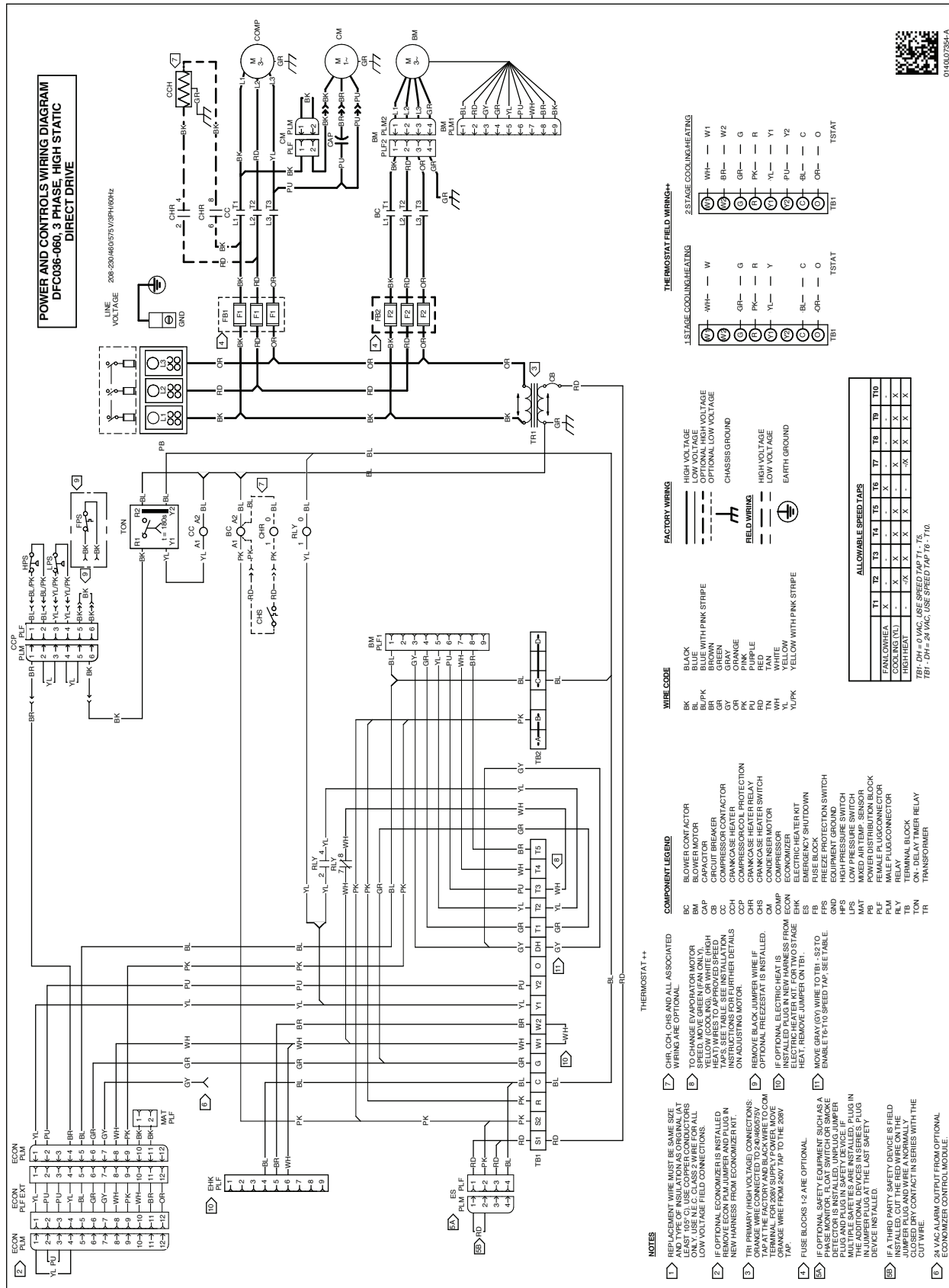

**WARNING**

High Voltage: Disconnect all power before servicing or installing this unit. Multiple power sources may be present. Failure to do so may cause property damage, personal injury, or death.

Wiring is subject to change. Always refer to the wiring diagram on the unit for the most up-to-date wiring.

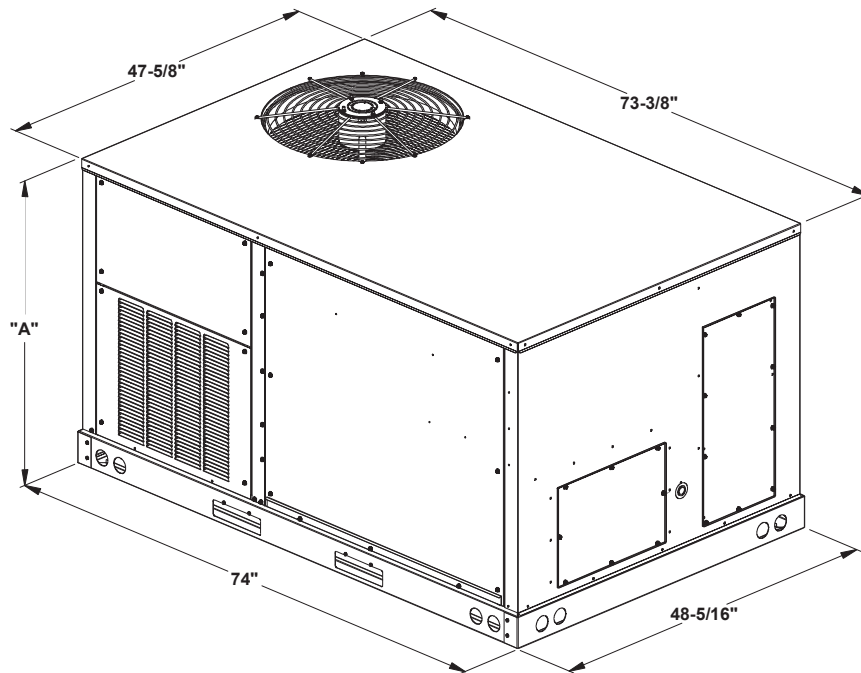

MODEL SIZE	DIM "A"
3 ton AC	39 7/8"
4 ton AC	39 7/8"
5 ton AC	39 7/8"
6 ton AC	43 1/2"

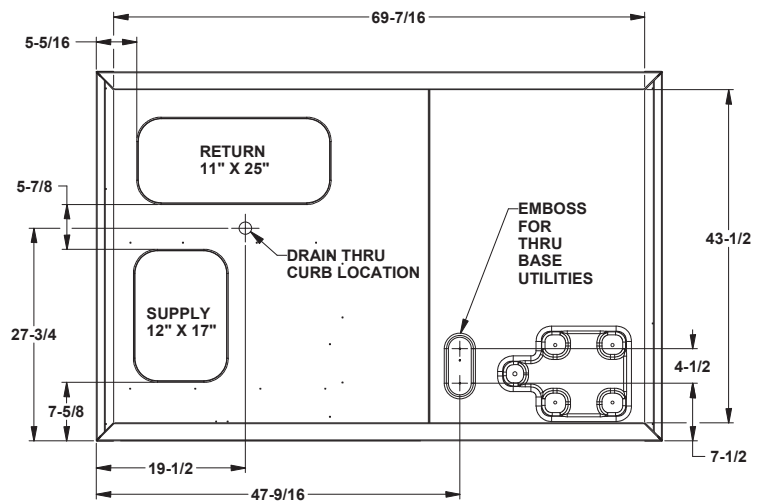
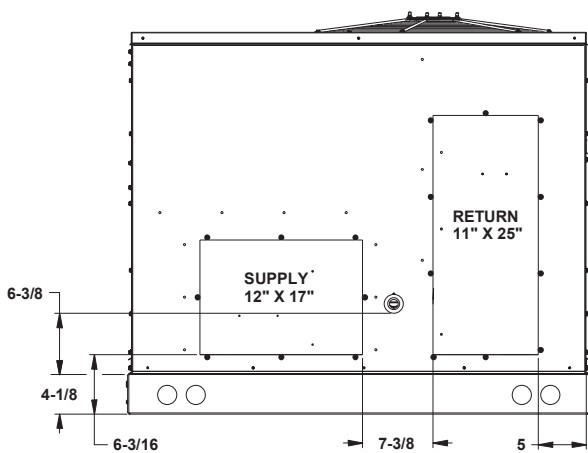

# Electrical Connections

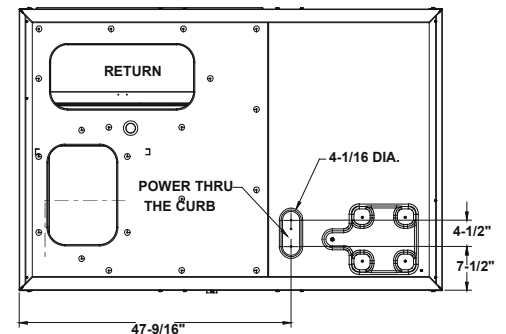
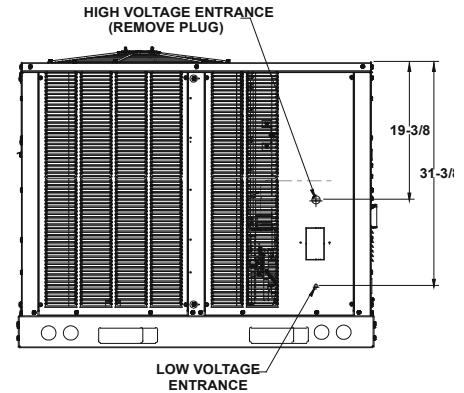
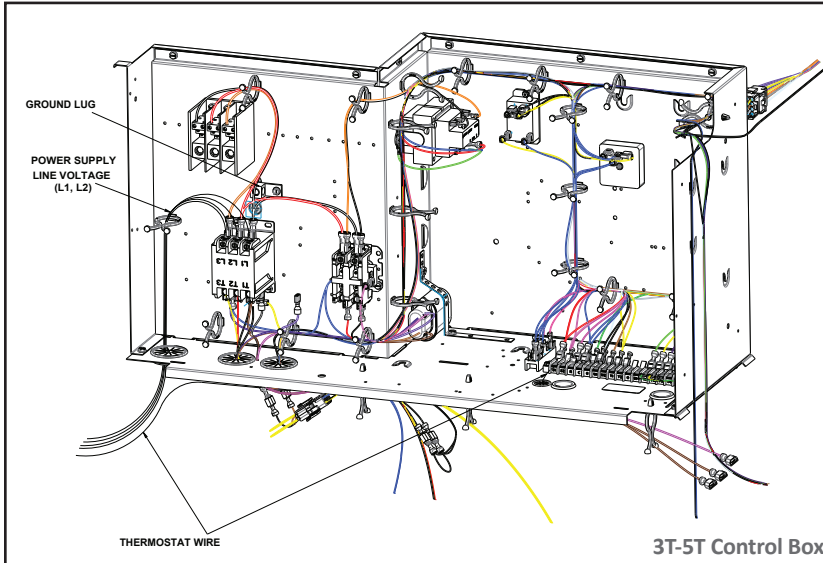

**Electrical Entrance and thru Curb  
(Bottom View of Unit)**

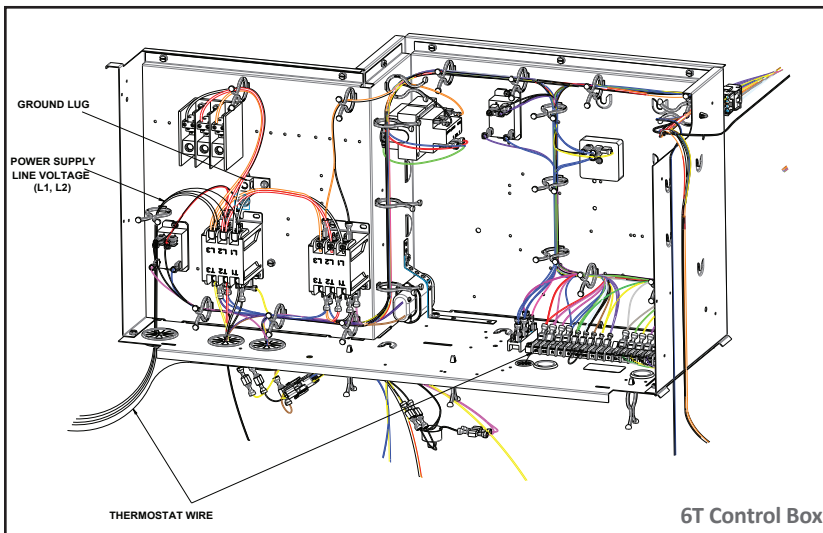

## Unit Clearances

### Service Clearance

Allow for recommended service clearances as shown in figure to the right. In situations that have multiple units, a 36" minimum clearance is required between the condenser coils. A clearance of 48" is recommended on all sides of the unit to allow service access and to ensure proper ventilation and condenser airflow. The top of the unit should be unobstructed. Provide a roof walkway along the sides of the unit for service and access to controls and components. Contact your Daikin sales representative for service requirements less than those recommended.

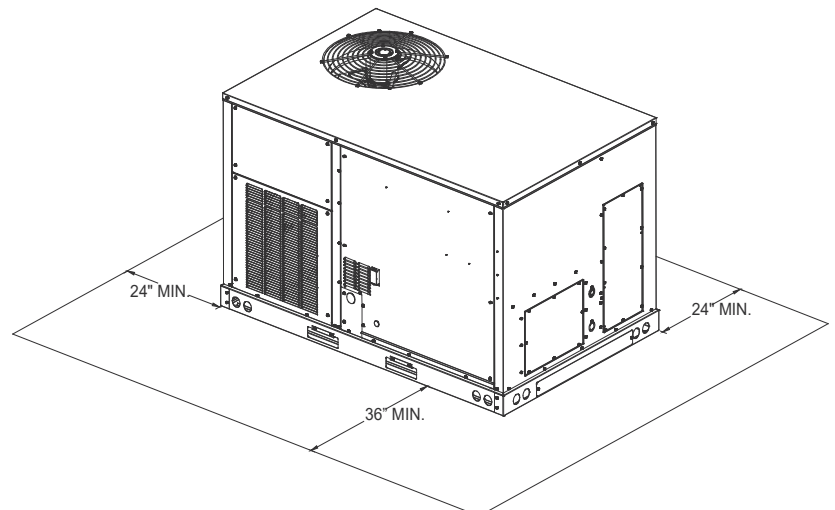

## Unit Location

The structural engineer must verify that the roof has adequate support and ability to minimize deflection. Take extreme caution when using on a wooden roof structure. Unit condenser coils should be in a location that avoids any heated exhaust air.

Allow sufficient space around the unit for maintenance/service clearance. Consult your Daikin sales representative if available clearances do not meet minimum recommendations.

Where code considerations, such as the NEC, require extended clearances, these take precedence.

Provisions for forks have been included in the unit base frame. No other fork locations are approved.

- » Unit must be lifted by the four lifting holes located at the base frame corners.
- » Lifting cables should be attached to the unit with shackles.
- » The distance between the crane hook and the top of the unit must not be less than 60”.
- » Two spreader bars must span over the unit to prevent damage to the cabinet by the lift cables. Spreader bars must be of sufficient length so that cables do not come in contact with the unit during transport. Remove wood struts mounted beneath unit base

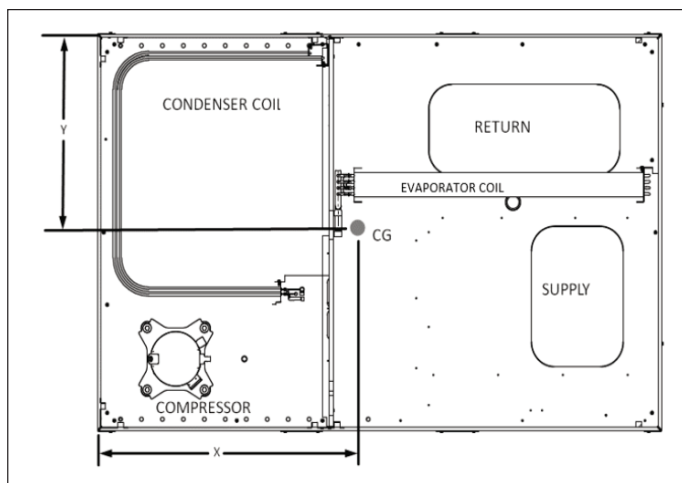

CORNER & CENTER-OF-GRAVITY LOCATIONS

frame before setting unit on roof curb. These struts are intended to protect unit base frame from forklift damage. To remove the struts, extract the sheet metal retainers and pull the struts through the base of the unit. Refer to rigging label on the unit.

**Important:** If using bottom discharge with roof curb, duct-work should be attached to the curb prior to installing the unit. Refer to the Roof Curb Installation Instructions for proper curb installation. Curbing must be installed in compliance with the National Roofing Contractors Association Manual. Lower unit carefully onto roof mounting curb. While rigging the unit, the center of gravity will cause the condenser end to be lower than the supply air end. Bring condenser end of unit into alignment with the curb. With condenser end of the unit resting on curb member and using curb as a fulcrum, lower opposite end of the unit until entire unit is seated on the curb. When a rectangular cantilever curb is used, take care to center the unit. Check for proper alignment and orientation of supply and return openings with duct.

## Roof Curb Installation

The roof curb is field-assembled and must be installed level (within 1/16” per foot side to side). A sub-base must be constructed by the contractor in applications involving pitched roofs. Gaskets are furnished and must be installed between the unit and curb. For proper installation, follow NRCA guidelines. In applications requiring post and rail installation, an I-beam securely mounted on multiple posts should support the unit on each side. In addition, the insulation on the underside of the unit should be protected from the elements. Applications in geographic areas subjected to seismic or hurricane conditions must meet code requirements for fastening the unit to the curb and the curb to the building structure. For further and more detailed information please refer to our Daikin Light Commercial Packaged unit IOD.

## Weights

Model	Shipping Weight (lbs)	Operating Weight (lbs)	Corner Weights (lbs)				Length X (in)	Width Y (in)
			A	B	C	D		
DFC0361D	554	484	117	142	80	145	34 <sup>3</sup> / <sub>16</sub>	28 <sup>3</sup> / <sub>16</sub>
DFC0363D	552	482	117	140	80	145	34 <sup>9</sup> / <sub>16</sub>	28 <sup>9</sup> / <sub>16</sub>
DFC0364D	560	490	117	142	80	151	34 <sup>3</sup> / <sub>16</sub>	28 <sup>3</sup> / <sub>16</sub>
DFC0367D	560	490	117	142	80	151	34 <sup>3</sup> / <sub>16</sub>	28 <sup>3</sup> / <sub>16</sub>
DFC0481D	577	507	134	152	87	134	32 <sup>3</sup> / <sub>16</sub>	27 <sup>3</sup> / <sub>16</sub>
DFC0483D	572	502	134	147	87	134	32 <sup>9</sup> / <sub>16</sub>	27 <sup>1</sup> / <sub>16</sub>
DFC0484D	576	506	134	147	87	138	32 <sup>3</sup> / <sub>16</sub>	27 <sup>3</sup> / <sub>16</sub>
DFC0487D	576	506	134	147	87	138	32 <sup>3</sup> / <sub>16</sub>	27 <sup>3</sup> / <sub>16</sub>
DFC0601D	582	512	113	166	104	129	33 <sup>11</sup> / <sub>16</sub>	27 <sup>13</sup> / <sub>16</sub>
DFC0603D	578	508	113	162	104	129	33 <sup>11</sup> / <sub>16</sub>	27 <sup>11</sup> / <sub>16</sub>
DFC0604D	582	512	113	162	104	133	34 <sup>3</sup> / <sub>16</sub>	27 <sup>13</sup> / <sub>16</sub>
DFC0607D	582	512	113	162	104	133	34 <sup>3</sup> / <sub>16</sub>	27 <sup>13</sup> / <sub>16</sub>
DFC0723D	651	581	143	178	90	170	33 <sup>3</sup> / <sub>16</sub>	28 <sup>153</sup> / <sub>16</sub>
DFC0724D	651	581	143	178	90	170	33 <sup>3</sup> / <sub>16</sub>	28 <sup>153</sup> / <sub>16</sub>
DFC0727D	651	581	143	178	90	170	33 <sup>3</sup> / <sub>16</sub>	28 <sup>153</sup> / <sub>16</sub>

For details on accessories refer to document **PM-LC-ACCESSORIES**

