

PACKAGED AIR CONDITIONER UNIT 3-6 TON DIRECT DRIVE BASE EFFICIENCY LIGHT COMMERCIAL DFC MODELS INSTALLATION INSTRUCTIONS

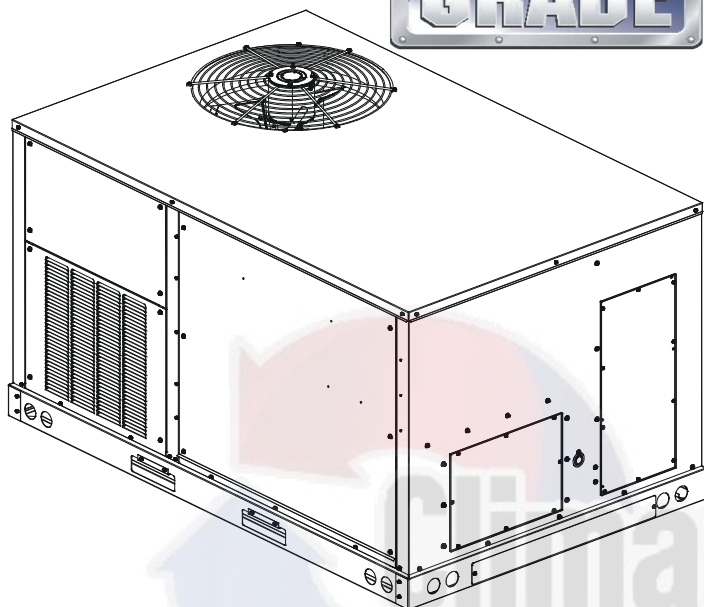

TABLE OF CONTENTS

- REPLACEMENT PARTS.....2
- SAFETY INSTRUCTIONS.....2
- GENERAL INFORMATION.....2
- UNIT LOCATION.....3
- CLEARANCES.....5
- ROOF CURB POST-INSTALLATION CHECKS.....5
- ROOF TOP DUCT CONNECTIONS.....5
- RIGGING DETAILS.....5
- ELECTRICAL WIRING.....7
- CIRCULATING AIR AND FILTERS.....9
- CONDENSATE DRAIN CONNECTION.....9
- STARTUP, ADJUSTMENTS, AND CHECKS.....9
- AIR FLOW ADJUSTMENTS.....10
- MAINTENANCE.....12
- APPENDIX A BLOWER PERFORMANCE TABLES.....15
- APPENDIX B ELECTRICAL DATA.....30
- APPENDIX C UNIT DIMENSIONS.....35
- APPENDIX D AIR FLOW FOR ELECTRIC HEAT.....36
- WIRING DIAGRAMS.....37
- STARTUP CHECKLIST.....41



! WARNING

ONLY PERSONNEL THAT HAVE BEEN TRAINED TO INSTALL, ADJUST, SERVICE OR REPAIR (HEREINAFTER, "SERVICE") THE EQUIPMENT SPECIFIED IN THIS MANUAL SHOULD SERVICE THE EQUIPMENT. THE MANUFACTURER WILL NOT BE RESPONSIBLE FOR ANY INJURY OR PROPERTY DAMAGE ARISING FROM IMPROPER SERVICE OR SERVICE PROCEDURES. IF YOU SERVICE THIS UNIT, YOU ASSUME RESPONSIBILITY FOR ANY INJURY OR PROPERTY DAMAGE WHICH MAY RESULT. IN ADDITION, IN JURISDICTIONS THAT REQUIRE ONE OR MORE LICENSES TO SERVICE THE EQUIPMENT SPECIFIED IN THIS MANUAL, ONLY LICENSED PERSONNEL SHOULD SERVICE THE EQUIPMENT. IMPROPER INSTALLATION, ADJUSTMENT, SERVICING OR REPAIR OF THE EQUIPMENT SPECIFIED IN THIS MANUAL, OR ATTEMPTING TO INSTALL, ADJUST, SERVICE OR REPAIR THE EQUIPMENT SPECIFIED IN THIS MANUAL WITHOUT PROPER TRAINING MAY RESULT IN PRODUCT DAMAGE, PROPERTY DAMAGE, PERSONAL INJURY OR DEATH.

! WARNING

DO NOT BYPASS SAFETY DEVICES.

! WARNING

THE APPLIANCE IS NOT TO BE USED BY PERSONS (INCLUDING CHILDREN) WITH REDUCED CAPABILITIES, OR LACK OF EXPERIENCE AND KNOWLEDGE, UNLESS THEY HAVE BEEN GIVEN SUPERVISION OR INSTRUCTION.

! WARNING

CHILDREN BEING SUPERVISED NOT TO PLAY WITH THE APPLIANCE.

Our continuing commitment to quality products may mean a change in specifications without notice.

© 2021 **DAIKIN MANUFACTURING COMPANY, L.P.**

19001 Kermier Rd. Waller, TX 77484

www.daikincomfort.com



REPLACEMENT PARTS

ORDERING PARTS

When reporting shortages or damages, or ordering repair parts, give the complete unit model and serial numbers as stamped on the unit's nameplate.

Replacement parts for this appliance are available through your contractor or local distributor. For the location of your nearest distributor, see website www.daikinac.com or contact:

EQUIPMENT SUPPORT
DAIKIN NORTH AMERICA LLC
19001 KERMIER ROAD
WALLER, TEXAS 77484
855-770-5678

SAFETY INSTRUCTIONS



RECOGNIZE THIS SYMBOL AS A SAFETY PRECAUTION.

These installation instructions cover the **outdoor** installation of single package heating and cooling units. See the Specification Sheet applicable to your model for information regarding accessories.

***NOTE: PLEASE CONTACT YOUR DISTRIBUTOR OR OUR WEBSITE FOR THE APPLICABLE SPECIFICATION SHEET REFERRED TO IN THIS MANUAL.**

TO THE INSTALLER

Before installing this unit, please read this manual to familiarize yourself on the specific items which must be adhered to, including maximum external static pressure to unit, air temperature rise, minimum or maximum CFM and motor speed connections.

Keep this literature in a safe place for future reference.



CAUTION

SHEET METAL PARTS, SCREWS, CLIPS AND SIMILAR ITEMS INHERENTLY HAVE SHARP EDGES, AND IT IS NECESSARY THAT THE INSTALLER AND SERVICE PERSONNEL EXERCISE CAUTION.



WARNING

DO NOT CONNECT TO OR USE ANY DEVICE THAT IS NOT DESIGN CERTIFIED BY THE MANUFACTURER FOR USE WITH THIS UNIT. SERIOUS PROPERTY DAMAGE, PERSONAL INJURY, REDUCED UNIT PERFORMANCE AND/OR HAZARDOUS CONDITIONS MAY RESULT FROM THE USE OF SUCH NON-APPROVED DEVICES.



WARNING

TO AVOID PROPERTY DAMAGE, PERSONAL INJURY OR DEATH, DO NOT USE THIS UNIT IF ANY PART HAS BEEN UNDER WATER. IMMEDIATELY CALL A QUALIFIED SERVICE TECHNICIAN TO INSPECT THE FURNACE AND TO REPLACE ANY PART OF THE CONTROL SYSTEM AND ANY GAS CONTROL HAVING BEEN UNDER WATER.



WARNING

THIS UNIT MUST NOT BE USED AS A "CONSTRUCTION HEATER" DURING THE FINISHING PHASES OF CONSTRUCTION ON A NEW STRUCTURE. THIS TYPE OF USE MAY RESULT IN PREMATURE FAILURE OF THE UNIT DUE TO EXTREMELY LOW RETURN AIR TEMPERATURE AND EXPOSURE TO CORROSIVE OR VERY DIRTY ATMOSPHERES.



WARNING

HIGH VOLTAGE!
DISCONNECT ALL POWER BEFORE SERVICING OR INSTALLING THIS UNIT. MULTIPLE POWER SOURCES MAY BE PRESENT. FAILURE TO DO SO MAY CAUSE PROPERTY DAMAGE, PERSONAL INJURY OR DEATH.



WARNING

TO PREVENT THE RISK OF PROPERTY DAMAGE, PERSONAL INJURY, OR DEATH, DO NOT STORE COMBUSTIBLE MATERIALS OR USE GASOLINE OR OTHER FLAMMABLE LIQUIDS OR VAPORS IN THE VICINITY OF THIS APPLIANCE.

GENERAL INFORMATION



WARNING

TO PREVENT PROPERTY DAMAGE, PERSONAL INJURY OR DEATH, DUE TO FIRE, EXPLOSIONS, SMOKE, SOOT, CONDENSATION, ELECTRIC SHOCK OR CARBON MONOXIDE, THIS UNIT MUST BE PROPERLY INSTALLED, REPAIRED, OPERATED, AND MAINTAINED.

This unit is approved for outdoor installation ONLY.

Rated performance is achieved after 20 hours of operation. Rated performance is delivered at the specified airflow. See product specification sheet for light commercial models. Specification sheets can be found at www.daikinac.com for Daikin brand products. Within the website, please select the commercial products menu and then select the submenu for the type of product to be installed, such as air conditioners or heat pumps, to access a list of product pages that each contain links to that model's specification sheet.

To assure that your unit operates safely and efficiently, it must be installed, operated, and maintained in accordance with these installation and operating instructions, all local building codes and ordinances.

EPA REGULATIONS

IMPORTANT: THE UNITED STATES ENVIRONMENTAL PROTECTION AGENCY (EPA) HAS ISSUED VARIOUS REGULATIONS REGARDING THE INTRODUCTION AND DISPOSAL OF REFRIGERANTS IN THIS UNIT. FAILURE TO FOLLOW THESE REGULATIONS MAY HARM THE ENVIRONMENT AND CAN LEAD TO THE IMPOSITION OF SUBSTANTIAL FINES. BECAUSE REGULATIONS MAY VARY DUE TO PASSAGE OF NEW LAWS, WE SUGGEST A CERTIFIED TECHNICIAN PERFORM ANY WORK DONE ON THIS UNIT. SHOULD YOU HAVE ANY QUESTIONS PLEASE CONTACT THE LOCAL OFFICE OF THE EPA.

NATIONAL CODES

This product is designed and manufactured to permit installation in accordance with National Codes. It is the installer's responsibility to install the product in accordance with National Codes and/or prevailing local codes and regulations.

The heating and cooling capacities of the unit should be greater than or equal to the design heating and cooling loads of the area to be conditioned. The loads should be calculated by an approved method or in accordance with ASHRAE Guide or Manual J - Load Calculations published by the Air Conditioning Contractors of America.

Obtain from:
American National Standards Institute
www.ansi.org

System design and installation should also, where applicable, follow information presented in accepted industry guides such as the ASHRAE Handbooks. The manufacturer assumes no responsibility for equipment installed in violation of any code or regulation. The mechanical installation of the packaged roof top units consists of making final connections between the unit and building services; supply and return duct connections; and drain connections (if required). The internal systems of the unit are completely factory-installed and tested prior to shipment.

Units are generally installed on a steel roof mounting curb assembly which has been shipped to the job site for installation on the roof structure prior to the arrival of the unit. The model number shown on the unit's identification plate identifies the various components of the unit such as refrigeration tonnage, heating output and voltage.

Carefully inspect the unit for damage including damage to the cabinetry. Any bolts or screws which may have loosened in transit must be re-tightened.

In the event of damage, the receiver should:

1. Make notation on delivery receipt of any visible damage to shipment or container.
2. Notify carrier promptly and request an inspection.
3. In case of concealed damage, carrier should be notified as soon as possible-preferably within 5 days.

4. File the claim with the following supporting documents:
 - a. Original Bill of Lading, certified copy, or indemnity bond.
 - b. Original paid freight bill or indemnity in lieu thereof.
 - c. Original invoice or certified copy thereof, showing trade and other discounts or reductions.
 - d. Copy of the inspection report issued by carrier representative at the time damage is reported to the carrier. The carrier is responsible for making prompt inspection of damage and for a thorough investigation of each claim. The distributor or manufacturer will not accept claims from dealers for transportation damage.

NOTE: WHEN INSPECTING THE UNIT FOR TRANSPORTATION DAMAGE, REMOVE ALL PACKAGING MATERIALS. RECYCLE OR DISPOSE OF THE PACKAGING MATERIAL ACCORDING TO LOCAL CODES.

PRE-INSTALLATION CHECKS

Carefully read all instructions for the installation prior to installing unit. Ensure each step or procedure is understood and any special considerations are taken into account before starting installation. Assemble all tools, hardware and supplies needed to complete the installation. Some items may need to be purchased locally.

UNIT LOCATION



WARNING

TO PREVENT POSSIBLE EQUIPMENT DAMAGE, PROPERTY DAMAGE, PERSONAL INJURY OR DEATH, THE FOLLOWING BULLET POINTS MUST BE OBSERVED WHEN INSTALLING THE UNIT.

IMPORTANT NOTE: REMOVE WOOD SHIPPING RAILS PRIOR TO INSTALLATION OF THE UNIT.

ALL INSTALLATIONS:

IMPORTANT NOTE: UNIT SHOULD BE ENERGIZED 24 HOURS PRIOR TO COMPRESSOR START UP TO ENSURE CRANKCASE HEATER HAS SUFFICIENTLY WARMED THE COMPRESSORS. COMPRESSOR DAMAGE MAY OCCUR IF THIS STEP IS NOT FOLLOWED.

NOTE: APPLIANCE IS SHIPPED FROM FACTORY FOR VERTICAL DUCT APPLICATION.

Proper installation of the unit ensures trouble-free operation. Improper installation can result in problems ranging from noisy operation to property or equipment damages, dangerous conditions that could result in injury or personal property damage and that are not covered by the warranty. Give this booklet to the user and explain it's provisions. The user should retain these instructions for future reference.

- To avoid possible illness or death of the building occupants, do NOT locate outside air intake device (economizer, manual fresh air intake, motorized fresh air intake) too close to an exhaust outlet, gas vent termination, or plumbing vent outlet. For specific distances required, consult local codes.
- Allow minimum clearances from the enclosure for fire protection, proper operation, and service access (see unit clearances). These clearances must be permanently maintained.
- When the unit is heating, the temperature of the return air entering the unit must be a minimum of 55° F.

GROUND LEVEL INSTALLATIONS ONLY:

- When the unit is installed on the ground adjacent to the building, a level concrete (or equal) base is recommended. Prepare a base that is 3” larger than the package unit footprint and a minimum of 3” thick.
- The base should also be located where no runoff of water from higher ground can collect in the unit.

ROOF TOP INSTALLATIONS ONLY:

- To avoid possible property damage or personal injury, the roof must have sufficient structural strength to carry the weight of the unit(s) and snow or water loads as required by local codes. Consult a structural engineer to determine the weight capabilities of the roof.
- The unit may be installed directly on wood floors or on Class A, Class B, or Class C roof covering material.
- To avoid possible personal injury, a safe, flat surface for service personnel should be provided.
- Adequate clearances from the unit to any adjacent public walkways, adjacent buildings, building openings or openable windows must be maintained in accordance with National Codes.

UNIT PRECAUTIONS

- Do not stand or walk on the unit.
- Do not drill holes anywhere in panels or in the base frame of the unit except where indicated. Unit access panels provide structural support.
- Do not remove any access panels until unit has been installed on roof curb or field supplied structure.
- Do not roll unit across finished roof without prior approval of owner or architect.
- Do not skid or slide on any surface as this may damage unit base. The unit must be stored on a flat, level surface. Protect the condenser coil because it is easily damaged.

ROOF CURB INSTALLATIONS ONLY:

Curb installations must comply with local codes and should be done in accordance with the established guidelines of the National Roofing Contractors Association.

Proper unit installation requires that the roof curb be firmly and permanently attached to the roof structure. Check for adequate fastening method prior to setting the unit on the curb.

Full perimeter roof curbs are available from the factory and are shipped unassembled. Field assembly, squaring, leveling and mounting on the roof structure are the responsibility of the installing contractor. All required hardware necessary for the assembly of the sheet metal curb is included in the curb accessory.

 WARNING
<p>TO PREVENT POSSIBLE EQUIPMENT DAMAGE, PROPERTY DAMAGE, PERSONAL INJURY OR DEATH, THE FOLLOWING BULLET POINTS MUST BE OBSERVED WHEN INSTALLING THE UNIT.</p>

- Sufficient structural support must be determined prior to locating and mounting the curb and package unit.
- Ductwork must be constructed using industry guidelines. The duct work must be placed into the roof curb before mounting the package unit. Our full perimeter curbs include duct connection frames to be assembled with the curb. Cantilevered type curbs are not available from the factory.
- Curb insulation, cant strips, flashing and general roofing material are furnished by the contractor.
- The curbs must be supported on parallel sides by roof members.
- The roof members must not penetrate supply and return duct opening areas as damage to the unit might occur.

NOTE: THE UNIT AND CURB ACCESSORIES ARE DESIGNED TO ALLOW VERTICAL DUCT INSTALLATION BEFORE UNIT PLACEMENT. DUCT INSTALLATION AFTER UNIT PLACEMENT IS NOT RECOMMENDED.

 CAUTION
<p>ALL CURBS LOOK SIMILAR. TO AVOID INCORRECT CURB POSITIONING, CHECK JOB PLANS CAREFULLY AND VERIFY MARKINGS ON CURB ASSEMBLY. INSTRUCTIONS MAY VARY IN CURB STYLES AND SUPERSEDES INFORMATION SHOWN.</p>

See the manual shipped with the roof curb for assembly and installation instructions.

CLEARANCES

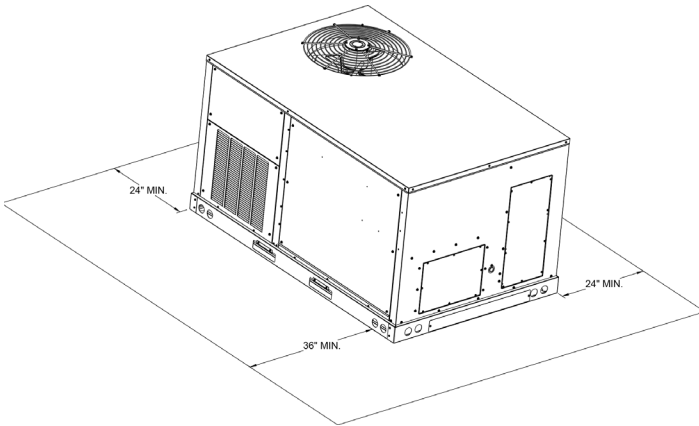

UNIT CLEARANCES

**In situations that have multiple units, a 36" minimum clearance is required between the condenser coils.*

Adequate clearance around the unit should be kept for safety, service, maintenance, and proper unit operation. A clearance of 48" is recommended on all sides of the unit to facilitate possible parts replacement, to allow service access and to insure proper ventilation and condenser airflow. The top of the unit should be completely unobstructed. If units are to be located under an overhang, there should be a minimum of 48" clearance and provisions made to deflect the warm discharge air out from the overhang. The unit should be installed remote from all building exhausts to inhibit ingestion of exhaust air into the unit fresh air intake.

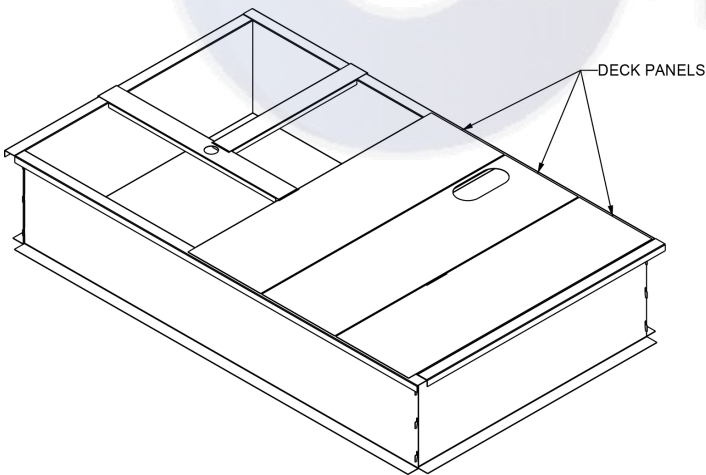

ROOF CURB INSTALLATION

ROOF CURB POST-INSTALLATION CHECKS

After installation, check the top of the curb, duct connection frame and duct flanges to make sure gasket has been applied properly. Gasket should be firmly applied to the top of the curb perimeter, duct flanges and any exposed duct connection frame. If gasket is loose, re-apply using strong weather resistant adhesive.

PROTRUSION

Inspect curb to ensure that none of the utility services (electric) routed through the curb protrude above the curb.



CAUTION

IF PROTRUSIONS EXIST, DO NOT ATTEMPT TO SET UNIT ON CURB.

ROOF TOP DUCT CONNECTIONS

Install all duct connections on the unit before placing the unit on rooftop.

HORIZONTAL DISCHARGE

Refer to IOD-7082 included in the literature pack for installing horizontal duct covers.

Flexible duct connectors between the unit and ducts are recommended. Insulate and weatherproof all external ductwork and joints as required and in accordance with local codes.

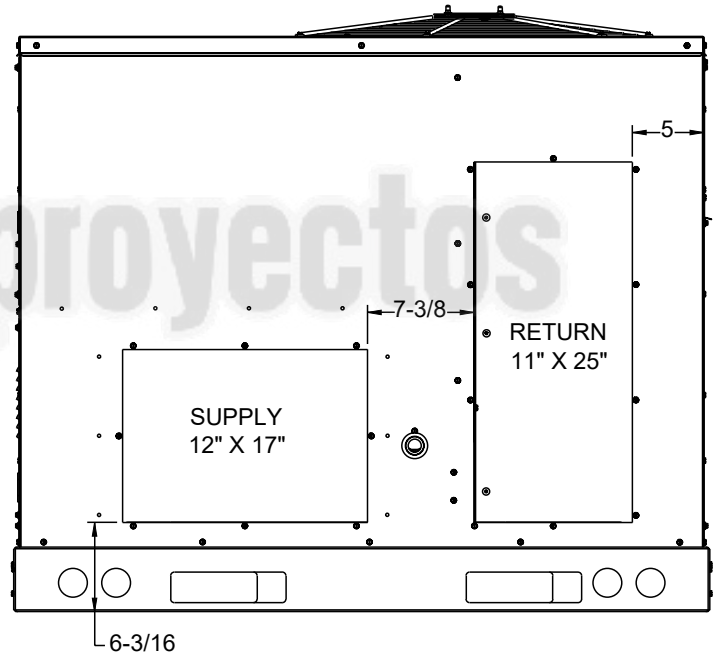

HORIZONTAL DISCHARGE DUCT CONNECTIONS

RIGGING DETAILS



WARNING

TO PREVENT PROPERTY DAMAGE, THE UNIT SHOULD REMAIN IN AN UPRIGHT POSITION DURING ALL RIGGING AND MOVING OPERATIONS. TO FACILITATE LIFTING AND MOVING WHEN A CRANE IS USED, PLACE THE UNIT IN AN ADEQUATE CABLE SLING.



CAUTION

IF UNITS ARE LIFTED TWO AT A TIME, THE FORK HOLES ON THE CONDENSER END OF THE UNIT MUST NOT BE USED. MINIMUM FORK LENGTH IS 42" TO PREVENT DAMAGE TO THE UNIT; HOWEVER, 48" IS RECOMMENDED.

PROVISIONS FOR FORKS HAVE BEEN INCLUDED IN THE UNIT BASE FRAME. NO OTHER FORK LOCATIONS ARE APPROVED.



WARNING

TO PREVENT POSSIBLE EQUIPMENT DAMAGE, PROPERTY DAMAGE, PERSONAL INJURY OR DEATH, THE FOLLOWING BULLET POINTS MUST BE OBSERVED WHEN INSTALLING THE UNIT.

- Unit must be lifted by the four lifting holes located at the base frame corners.
- Lifting cables should be attached to the unit with shackles.
- The distance between the crane hook and the top of the unit must not be less than 60".
- Two spreader bars must span over the unit to prevent damage to the cabinet by the lift cables. Spreader bars must be of sufficient length so that cables do not come in contact with the unit during transport. Remove wood struts mounted beneath unit base frame before setting unit on roof curb. These struts are intended to protect unit base frame from fork lift damage. Removal is accomplished by extracting the sheet metal retainers and pulling the struts through the base of the unit. Refer to rigging label on the unit.

IMPORTANT: IF USING BOTTOM DISCHARGE WITH ROOF CURB, DUCTWORK SHOULD BE ATTACHED TO THE CURB PRIOR TO INSTALLING THE UNIT. DUCTWORK DIMENSIONS ARE SHOWN IN ROOF CURB INSTALLATION INSTRUCTIONS.

Refer to the Roof Curb Installation Instructions for proper curb installation. Curbing must be installed in compliance with the National Roofing Contractors Association Manual.

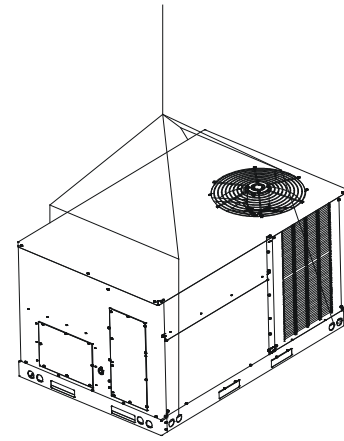

To assist in determining rigging requirements, unit weights and center of gravity are shown as follows:

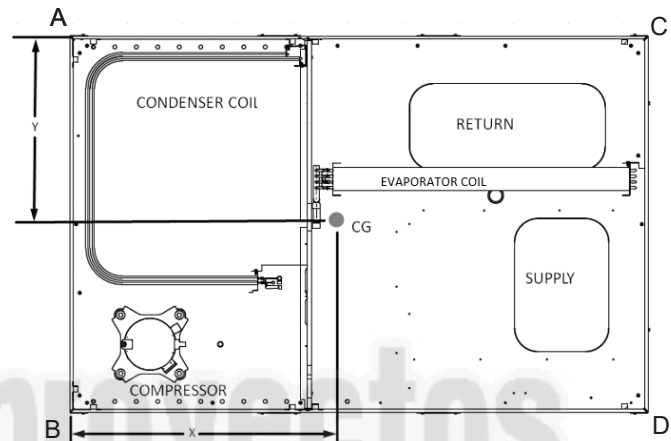

CORNER AND CENTER OF GRAVITY LOCATIONS

NOTE: UNIT SHOULD BE LIFTED AT A POINT ABOVE CENTER OF GRAVITY.

Model	Shipping Weight (lbs)	Operating Weight (lbs)	Corner Weights (lbs)				Length X (in)	Width Y (in)
			A	B	C	D		
DFC0361D	554	484	117	142	80	145	34.4	28.6
DFC0363D	552	482	117	140	80	145	34.5	28.6
DFC0364D	560	490	117	142	80	151	34.9	28.9
DFC0367D	560	490	117	142	80	151	34.9	28.9
DFC0481D	577	507	134	152	87	134	32.3	27.2
DFC0483D	572	502	134	147	87	134	32.6	27.0
DFC0484D	576	506	134	147	87	138	32.9	27.2
DFC0487D	576	506	134	147	87	138	32.9	27.2
DFC0601D	582	512	113	166	104	129	33.7	27.8
DFC0603D	578	508	113	162	104	129	33.9	27.7
DFC0604D	582	512	113	162	104	133	34.3	27.8
DFC0607D	582	512	113	162	104	133	34.3	27.8
DFC0723D	651	581	143	178	90	170	33.1	28.9
DFC0724D	651	581	143	178	90	170	33.1	28.9
DFC0727D	651	581	143	178	90	170	33.1	28.9

THE NUMBERS MAY SLIGHTLY VARY DEPENDING ON INSTALLED OPTIONS.



CAUTION

TO PREVENT DAMAGE TO THE WIRING, PROTECT WIRING FROM SHARP EDGES. FOLLOW NATIONAL ELECTRICAL CODE AND ALL LOCAL CODES AND ORDINANCES. DO NOT ROUTE WIRES THROUGH REMOVABLE ACCESS PANELS.



CAUTION

TO PREVENT SEVERE DAMAGE TO THE BOTTOM OF THE UNIT, DO NOT FORK LIFT UNIT AFTER WOOD STRUTS HAVE BEEN REMOVED.

Bring condenser end of unit into alignment with the curb first. Lower unit carefully onto roof mounting curb. When a rectangular cantilever curb is used, care should be taken to center the unit. Check for proper alignment and orientation of supply and return openings with duct.

RIGGING REMOVAL



CAUTION

TO PREVENT DAMAGE TO THE UNIT, DO NOT ALLOW CRANE HOOKS AND SPREADER BARS TO REST ON THE ROOF OF THE UNIT.

Remove spreader bars, lifting cables and other rigging equipment.

ELECTRICAL WIRING



WARNING

HIGH VOLTAGE!
DISCONNECT ALL POWER BEFORE SERVICING OR INSTALLING THIS UNIT. MULTIPLE POWER SOURCES MAY BE PRESENT. FAILURE TO DO SO MAY CAUSE PROPERTY DAMAGE, PERSONAL INJURY OR DEATH.



WARNING

HIGH VOLTAGE!
TO AVOID PERSONAL INJURY OR DEATH DUE TO ELECTRICAL SHOCK, DO NOT TAMPER WITH FACTORY WIRING. THE INTERNAL POWER AND CONTROL WIRING OF THESE UNITS ARE FACTORY-INSTALLED AND HAVE BEEN THOROUGHLY TESTED PRIOR TO SHIPMENT. CONTACT YOUR LOCAL REPRESENTATIVE IF ASSISTANCE IS REQUIRED.



CAUTION

CONDUIT AND FITTINGS MUST BE WEATHER-TIGHT TO PREVENT WATER ENTRY INTO THE BUILDING.

For unit protection, use a fuse or HACR circuit breaker that is in excess of the circuit ampacity, but less than or equal to the maximum overcurrent protection device. DO NOT EXCEED THE MAXIMUM OVERCURRENT DEVICE SIZE SHOWN ON UNIT DATA PLATE.

All line voltage connections must be made through weatherproof fittings. All exterior power supply and ground wiring must be in approved weatherproof conduit.

The main power supply wiring to the unit and low voltage wiring to accessory controls must be done in accordance with these instructions, the latest edition of the National Electrical Code (ANSI/NFPA 70), and all local codes and ordinances.

The unit is factory wired for the voltage shown on the unit's data plate. Refer to model nomenclature in Appendix B for voltage requirement for your unit.

NOTE: IF SUPPLY VOLTAGE IS 208V, LEAD ON PRIMARY OF TRANSFORMER(S) MUST BE MOVED FROM THE 230V TO THE 208V TAP. REFER TO WIRING DIAGRAM ON UNIT FOR DETAILS.

Main power wiring should be sized for the minimum circuit ampacity shown on the unit's database. Size wires in accordance with the ampacity tables in [Article 310 of the National Electrical Code](#). If long wires are required, it may be necessary to increase the wire size to prevent excessive voltage drop. Wires should be sized for a maximum of 3% voltage drop.



CAUTION

TO AVOID RISK OF PROPERTY DAMAGE, PERSONAL INJURY OR FIRE, USE ONLY COPPER CONDUCTORS.



CAUTION

LABEL ALL WIRES PRIOR TO DISCONNECTION WHEN SERVICING CONTROLS. WIRING ERRORS CAN CAUSE IMPROPER AND DANGEROUS OPERATION. VERIFY PROPER OPERATION AFTER SERVICING.

NOTE: A WEATHER-TIGHT DISCONNECT SWITCH, PROPERLY SIZED FOR THE UNIT TOTAL LOAD, MUST BE FIELD OR FACTORY INSTALLED. AN EXTERNAL FIELD SUPPLIED DISCONNECT MAY BE MOUNTED ON THE EXTERIOR PANEL. SWITCH SHALL BE PROVIDED TO ENSURE ALL-POLE DISCONNECTION FROM THE SUPPLY MAINS.

Ensure the data plate is not covered by the field-supplied disconnect switch.

- Some disconnect switches are not fused. Protect the power leads at the point of distribution in accordance with the unit data plate.
- The unit must be electrically grounded in accordance with local codes or, in the absence of local codes, with the latest edition of the National Electrical Code ANSI/NFPA 70, and/or the Canadian Electrical Code, CSA C22.1, Part 1. A ground lug is provided for this purpose. Do not use the ground lug for connecting a neutral conductor.

- Connect power wiring to the electrical power block located within the main control box.

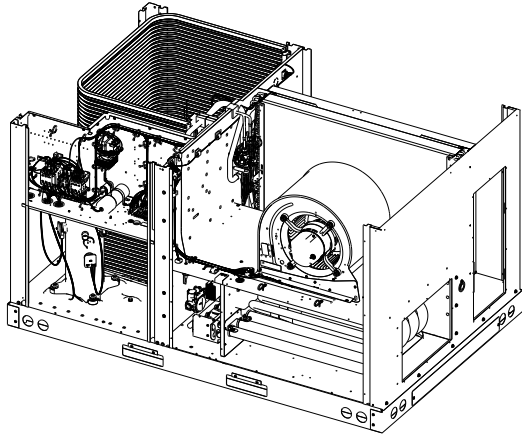

CONTROL BOX

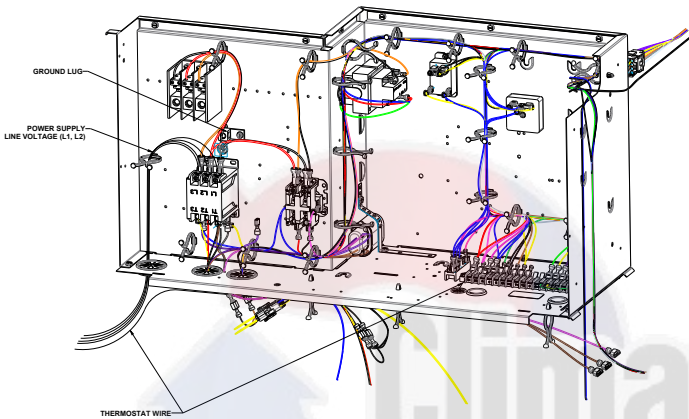

3T-5T AC CONTROL BOX

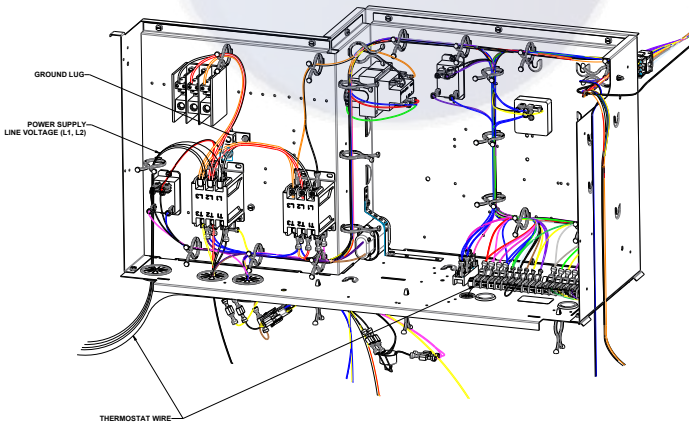

6T AC CONTROL BOX

AREAS WITHOUT CONVENIENCE OUTLET

It is recommended that an independent 115V power source be brought to the vicinity of the roof top unit for portable lights and tools used by the service mechanic.

NOTE: REFER TO LOCAL CODES FOR REQUIREMENTS. THESE OUTLETS CAN ALSO BE FACTORY INSTALLED.

UNITS INSTALLED ON ROOF TOPS

Main power and low voltage wiring may enter the unit through the condenser end of unit or through the roof curb. Install conduit connectors at the desired entrance locations. External connectors must be weatherproof. All holes in the unit base must be sealed (including those around conduit nuts) to prevent water leakage into building. All required conduit and fittings are to be field supplied.

Supply voltage to roof top unit must not vary by more than 10% of the value indicated on the unit data plate. Phase voltage unbalance must not exceed 2%. Contact your local power company for correction of improper voltage or phase unbalance.

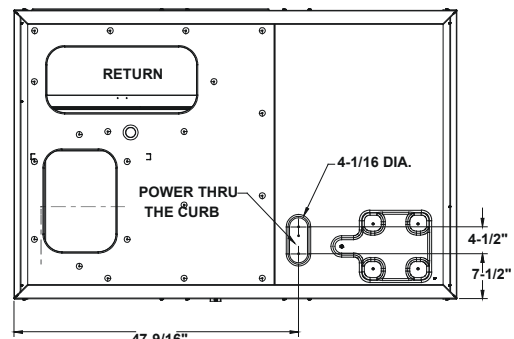
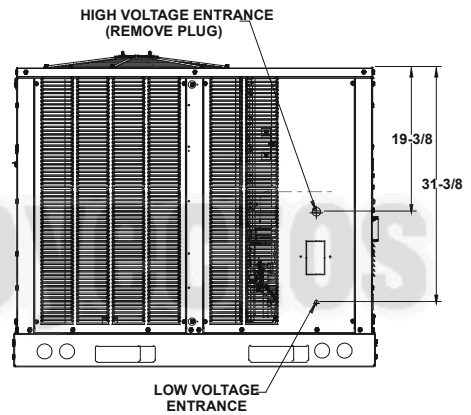

ELECTRICAL ENTRANCE AND THRU CURB (BOTTOM VIEW OF UNIT)

NOTE: DEPENDING ON THE OPTIONS INSTALLED, THE LOCATION OF THE COMPONENTS MAY VARY IN SOME MODELS.



WARNING

FAILURE OF UNIT DUE TO OPERATION ON IMPROPER LINE VOLTAGE OR WITH EXCESSIVE PHASE UNBALANCE CONSTITUTES PRODUCT ABUSE AND IS NOT COVERED BY THE WARRANTY AND MAY CAUSE SEVERE DAMAGE TO THE UNIT ELECTRICAL COMPONENTS.

LOW VOLTAGE CONTROL WIRING

1. A 24V thermostat must be installed for unit operation unless the unit is equipped with factory installed DDC control.
2. Locate thermostat or remote sensor in the conditioned space where it will sense average temperature. Do not locate the device where it may be directly exposed to supply air, sunlight or other sources of heat. Follow installation instructions packaged with the thermostat.

- Use #18 AWG wire for 24V control wiring runs not exceeding 75 feet. Use #16 AWG wire for 24V control wiring runs not exceeding 125 feet. Use #14 AWG wire for 24V control wiring runs not exceeding 200 feet. Low voltage wiring may be National Electrical Code (NEC) Class 2 where permitted by local codes.
- Route thermostat wires from sub-base terminals to the unit. Control wiring should enter through the condenser panel opening or through curb indicated in "Electrical Entrance" figure. Connect thermostat and any accessory wiring to low voltage terminal block TB1 in the main control box.

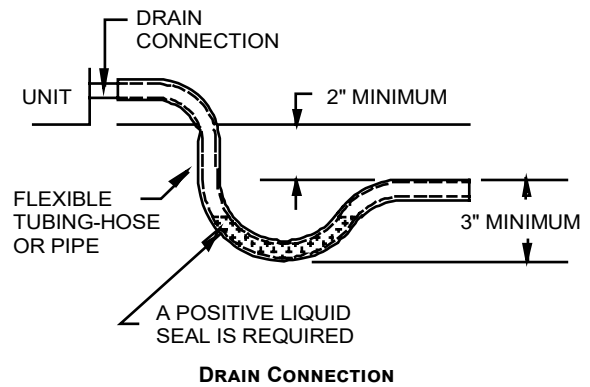

Install condensate drain trap as shown. Use $\frac{3}{4}$ " drain line and fittings or larger. Do not operate without trap.

HORIZONTAL DRAIN

Drainage of condensate directly onto the roof may be acceptable; refer to local code. It is recommended that a small drip pad of either stone, mortar, wood or metal be provided to prevent any possible damage to the roof.



VERTICAL DRAIN

To use the bottom drain connection, remove the drain plug from the bottom connection and install it in the horizontal connection.

CLEANING

Due to the fact that drain pans in any air conditioning unit will have some moisture in them, algae and fungus will grow due to airborne bacteria and spores. Periodic cleaning is necessary to prevent this build-up from plugging the drain.

STARTUP, ADJUSTMENTS, AND CHECKS

 WARNING	
<p>HIGH VOLTAGE! TO AVOID PERSONAL INJURY OR DEATH DUE TO ELECTRICAL SHOCK, BOND THE FRAME OF THIS UNIT TO THE BUILDING ELECTRICAL GROUND BY USE OF THE GROUNDING TERMINAL PROVIDED OR OTHER ACCEPTABLE MEANS. DISCONNECT ALL POWER BEFORE SERVICING OR INSTALLING THIS UNIT.</p>	

 CAUTION	
<p>TO PREVENT PROPERTY DAMAGE OR PERSONAL INJURY, DO NOT START THE UNIT UNTIL ALL NECESSARY PRE-CHECKS AND TESTS HAVE BEEN PERFORMED.</p>	

 WARNING	
<p>MOVING MACHINERY HAZARD! TO PREVENT POSSIBLE PERSONAL INJURY OR DEATH, DISCONNECT POWER TO THE UNIT AND PADLOCK IN THE "OFF" POSITION BEFORE SERVICING FANS.</p>	

NOTE: FIELD-SUPPLIED CONDUIT MAY NEED TO BE INSTALLED DEPENDING ON UNIT/CURB CONFIGURATION. USE #18 AWG SOLID CONDUCTOR WIRE WHENEVER CONNECTING THERMOSTAT WIRES TO TERMINALS ON SUB-BASE. DO NOT USE LARGER THAN #18 AWG WIRE. A TRANSITION TO #18 AWG WIRE MAY BE REQUIRED BEFORE ENTERING THERMOSTAT SUB-BASE.

NOTE: REFER TO UNIT WIRING DIAGRAMS FOR THERMOSTAT OR REMOTE SENSOR CONNECTIONS.

CIRCULATING AIR AND FILTERS

DUCTWORK

The supply duct from the unit through a wall may be installed without clearance. However, minimum unit clearances must be maintained (see "Clearances" section). The supply duct should be provided with an access panel large enough to inspect the air chamber downstream of the heat exchanger. A cover should be tightly attached to prevent air leaks.

Ductwork dimensions are shown in the roof curb installation manual.

If desired, supply and return duct connections to the unit may be made with flexible connections to reduce possible unit operating sound transmission.

CONDENSATE DRAIN CONNECTION

CONDENSATE DRAIN CONNECTION

A $\frac{3}{4}$ " female NPT drain connection is supplied on the end of the unit and bottom of the drain pan for condensate piping. An external trap must be installed for proper condensate drainage. Hand tighten drain fitting to the drain connection.

PRE-STARTUP INSTRUCTIONS

On new installations, or if a major component has been replaced, the operation of the unit must be checked.

Check unit operation as outlined in the following instructions. If any sparking, odors, or unusual sounds are encountered, shut off electrical power and recheck for wiring errors, or obstructions in or near the blower motors.

Duct covers must be removed before operating unit.

The Startup, Adjustments, and Checks procedure provides a step-by-step sequence which, if followed, will assure the proper startup of the equipment in the minimum amount of time. Air balancing of duct system is not considered part of this procedure. However, it is an important phase of any air conditioning system startup and should be performed upon completion of the Startup, Adjustments, and Checks procedure. The Startup, Adjustments, and Checks procedure at outside ambients below 55°F should be limited to a readiness check of the refrigeration system with the required final check and calibration left to be completed when the outside ambient rises above 55°F.

TEMPORARY HEATING OR COOLING

If the unit is to be used for temporary heating or cooling, a "Startup, Adjustments, and Checks" must first be performed in accordance with this manual. Damage or repairs due to failure to comply with these requirements are not covered under the warranty. **After** the machines are used for temporary heating or cooling, inspect the coils, fans, and motors for unacceptable levels of construction dust and dirt and install new filters.

CONTRACTOR RESPONSIBILITY

The installing contractor must be certain that:

- All supply and return air ductwork is in place, properly sealed, and corresponds with installation instructions.
- All thermostats and sensors are mounted and wired in accordance with installation instructions.
- All electric power, all gas, hot water or steam line connections, and the condensate drain installation have been made to each unit on the job. These main supply lines must be functional and capable of operating all units simultaneously.
- All filters are in place.

ROOF CURB INSTALLATION CHECK

Inspect the roof curb for correct installation. The unit and curb assembly should be level. Inspect the flashing of the roof mounting curb to the roof, especially at the corners, for good workmanship. Also check for leaks around gaskets. Note any deficiencies in a separate report and forward to the contractor.

OBSTRUCTIONS, FAN CLEARANCE AND WIRING

Remove any extraneous construction and shipping materials that may be found during this procedure. Rotate all fans manually to check for proper clearances and that

they rotate freely. Check for bolts and screws that may have jarred loose during shipment to the job site. Re-tighten if necessary. Re-tighten all electrical connections.

FIELD DUCT CONNECTIONS

Verify that all duct connections are tight and that there is no air bypass between supply and return.

FILTER SECTION CHECK

Remove filter section access panels and check that filters are properly installed. Note airflow arrows on filter frames.

PRE-STARTUP PRECAUTIONS

It is important to your safety that the unit has been properly grounded during installation. Check ground lug connection in main control box for tightness prior to closing circuit breaker or disconnect switch. Verify that supply voltage on line side of disconnect agrees with voltage on unit identification plate and is within the utilization voltage range as indicated in Appendix B Electrical Data.

System Voltage - That nominal voltage value assigned to a circuit or system for the purpose of designating its voltage class.

Nameplate Voltage - That voltage assigned to a piece of equipment for the purpose of designating its voltage class and for the purpose of defining the minimum and maximum voltage at which the equipment will operate.

Utilization Voltage - The voltage of the line terminals of the equipment at which the equipment must give fully satisfactory performance. Once it is established that supply voltage will be maintained within the utilization range under all system conditions, check and calculate if an unbalanced condition exists between phases. Calculate percent voltage unbalance as follows:

Three Phase Models Only

$$3) \text{ PERCENT VOLTAGE UNBALANCE} = 100 \times \frac{2) \text{ MAXIMUM VOLTAGE DEVIATIONS FROM AVERAGE VOLTAGE}}{1) \text{ AVERAGE VOLTAGE}}$$

HOW TO USE THE FORMULA:

EXAMPLE: Line to Neutral Voltage of 220, 216, and 213

1) Average Voltage = $220+216+213=649 / 3 = 216$

2) Maximum Voltage Deviations from Average Voltage = $220 - 216 = 4$

3) Percent Voltage Unbalance = $100 \times \frac{4}{216} = \frac{400}{216} = 1.8\%$

Percent voltage unbalance MUST NOT exceed 2%.

AIR FLOW ADJUSTMENTS

When the final adjustments are complete, the current draw of the motor should be checked and compared to the full load current rating of the motor. The amperage must not exceed the service factor stamped on the motor nameplate.

If an economizer is installed, check the unit operating balance with the economizer at full outside air and at minimum outside air.

High stage airflow setting to be between 300 and 500 CFM per ton. For models with electric heat the total airflow must not be less than that required for operation of the electric heaters. See Appendix D for minimum airflow for specific electric heaters.

NOTE: NEVER RUN CFM BELOW 300 CFM PER TON, EVAPORATOR FREEZING OR POOR UNIT PERFORMANCE IS POSSIBLE.

STANDARD STATIC DRIVE MOTOR

Adjust the CFM for the unit by changing the position of the low voltage leads on the terminal block TB1. Refer to Appendix A for blower performance at each speed tap

NOTE: IF MORE THAN ONE LEAD IS ENERGIZED SIMULTANEOUSLY, THE MOTOR WILL RUN AT THE HIGHER SPEED TAP.

Standard Static Drive Motors are set up to use motor speed taps T1-T5 Refer to Appendix A for blower performance at each speed tap.

Fan speed for G (Fan) is fixed at TB-1-T1 and cannot be moved.

Low Cool Y1, Yellow (YL) is movable and set to TB1-T1. Low Heat W1, White (WH) is movable and set to TB1-T2.

These wires can be moved together or separately and placed on any unoccupied terminal.

NOTE: ON UNITS WITH DDC CONTROLS INSTALLED, REFER TO THE DDC USER MANUAL FOR DETAILS ON MAKING AIRFLOW ADJUSTMENTS. INDIVIDUAL SETTINGS ARE AVAILABLE FOR FAN ONLY, LOW STAGE COOLING, HIGH STAGE COOLING, LOW STAGE HEATING, AND HIGH STAGE HEATING WHICH CAN BE ADJUSTED AS NEEDED TO MEET AIRFLOW REQUIREMENTS.

RECOMMENDED SPEED TAPS 3-5 TON STANDARD STATIC					
INDOOR MOTOR TAPS	T1	T2	T3	T4	T5
FAN (GR)	X	-	-	-	-
COOLING (YL)	-	X	X	X	X
HEATING (BR)	-	-	X	X	X

NOTE: IF MORE THAN ONE LEAD IS ENERGIZED SIMULTANEOUSLY, THE MOTOR WILL RUN AT THE HIGHER SPEED.

RECOMMENDED SPEED TAPS 3-5T HIGH STATIC										
INDOOR MOTOR TAPS	T1	T2	T3	T4	T5	T1'	T2'	T3'	T4'	T5'
FAN (GR)	X	-	-	-	-	X	-	-	-	-
COOLING (YL)	-	X	X	X	X	-	X	X	X	X
HIGH HEAT (BR)	-	X	X	X	X	-	X	X	X	X

RECOMMENDED SPEED TAPS 6T STANDARD AND HIGH STATIC										
INDOOR MOTOR TAPS	T1	T2	T3	T4	T5	T1'	T2'	T3'	T4'	T5'
FAN (GR)	X	-	-	-	-	X	-	-	-	-
COOLING STG1 (YL)	-	X	-	-	-	-	X	-	-	-
COOLING STG2 (PU)	-	-	X	X	X	-	-	X	X	X
HIGH HEAT (BR)	-	-	X	X	X	-	-	X	X	X

NOTE: FOR MOTORS WITH 10 SPEED TAPS DH = 0VAC USES SPEED TAPS T1-T5. DH = 24VAC USES SPEED TAPS T1'-T5'.

REFRIGERATION SYSTEM CHECKS

This unit is equipped with thermal expansion valves.

Ensure the hold-down bolts on the compressor are secure and have not vibrated loose during shipment. Check that the vibration grommets have been installed and visually check all piping for damage and leaks and repair if necessary. The entire system has been factory charged and tested, making it unnecessary to field charge. Factory refrigerant charge is shown on the unit's nameplate.

To confirm charge levels or, if a leak occurs and charge needs to be added to the system, it is recommended to evacuate the system and recharge refrigerant to the units nameplate specifications. This unit has been rated in the cooling mode at the AHRI rated conditions of indoor (80°F db / 67°F wb) and outdoor (95°F db). While operating at this condition the superheat and subcool should range as shown in the superheat and subcool table. Superheat should be measured at the suction service port located near the compressor. Subcool should be measured at the liquid line service port.

UNIT SUBCOOLING AND SUPERHEAT		
TONNAGE	SUPERHEAT (°F)	SUBCOOLING (°F)
3	8 - 10	14 - 16
4	8 - 10	14 - 16
5	11 - 13	15 - 17
6	9 - 11	17 - 19

START-UP PROCEDURE AND CHECKLIST

Begin with power turned off at all disconnects.

AIR CONDITIONING START-UP PROCEDURE



1. Ensure the thermostat is set to OFF and Fan is set to Auto.
2. Inspect all registers and set them to the normal open position.
3. Turn on the electrical supply at the disconnect.
4. Turn the fan switch to the "ON" position. The blower should operate after a 7 second delay.
5. Turn the fan switch to "Auto" position. The blower should stop after a 60 second delay.

6. Set the thermostat to Cool mode and slowly lower the cooling temperature until the unit starts. The compressor, blower and fan should now be operating. Allow the unit to run 10 minutes, make sure cool air is being supplied by the unit.
7. Check that the compressor is operating correctly. The scroll compressors in these units MUST operate in the proper rotation. To ensure the compressors are operating in the correct direction, check the compressor discharge line pressure or temperature after the compressor is started. The discharge pressure and discharge line temperature should increase. If this does not occur and the compressor is producing an exceptional amount of noise, this indicates that there is a phasing issue. Perform the following to correct:

- 7.1 Turn power to the unit OFF.
- 7.2 Switch any two leads of power supply at unit Single Point Power Block.
- 7.3 Turn power to the unit ON.
- 7.4 Perform step 7 again.

8. Turn the temperature setting to the highest position, stopping the unit. The indoor blower will continue to run for 60 seconds.
9. Turn the thermostat system switch to "OFF" and disconnect all power when servicing the unit.

NOTE: THE COMPRESSOR HAS 180 SECOND RE-START DELAY ON TIMER TO AVOID SHORT CYCLING.

 WARNING
<p>HIGH VOLTAGE! DISCONNECT ALL POWER BEFORE SERVICING OR INSTALLING THIS UNIT. MULTIPLE POWER SOURCES MAY BE PRESENT. FAILURE TO DO SO MAY CAUSE PROPERTY DAMAGE, PERSONAL INJURY OR DEATH.</p> 



FINAL SYSTEM CHECKS

10. Check to see if all supply and return air grilles are adjusted and the air distribution system is balanced for the best compromise between heating and cooling.
11. Check for air leaks in the ductwork. See Sections on Air Flow Adjustments.
12. Make sure the unit is free of "rattles", and the tubing in the unit is free from excessive vibration. Also make sure tubes or lines are not rubbing against each other or sheet metal surfaces or edges. If so, correct the trouble.
13. Set the thermostat at the appropriate setting for cooling and heating or automatic changeover for normal use.
14. Be sure the Owner is instructed on the unit operation, filter, servicing, correct thermostat operation, etc.

REFRIGERATION PERFORMANCE CHECK

Check that compressor RLA corresponds to values shown in Appendix B. RLA draw can be much lower than values listed at low load conditions and low ambient condensing temperatures. Values in Appendix B can slightly exceed at high load conditions and high ambient condensing temperatures.

MAINTENANCE

 WARNING
<p>HIGH VOLTAGE! DISCONNECT ALL POWER BEFORE SERVICING OR INSTALLING THIS UNIT. MULTIPLE POWER SOURCES MAY BE PRESENT. FAILURE TO DO SO MAY CAUSE PROPERTY DAMAGE, PERSONAL INJURY OR DEATH.</p> 

 WARNING
<p>TO PREVENT PERSONAL INJURY OR DEATH DUE TO IMPROPER INSTALLATION, ADJUSTMENT, ALTERATION, SERVICE OR MAINTENANCE, REFER TO THIS MANUAL. FOR ADDITIONAL ASSISTANCE OR INFORMATION, CONSULT A QUALIFIED INSTALLER, SERVICER AGENCY OR THE GAS SUPPLIER.</p>

 CAUTION
<p>SHEET METAL PARTS, SCREWS, CLIPS AND SIMILAR ITEMS INHERENTLY HAVE SHARP EDGES, AND IT IS NECESSARY THAT THE INSTALLER AND SERVICE PERSONNEL EXERCISE CAUTION.</p>

The Self Contained Packaged Air Conditioner should operate for many years without excessive service calls if the unit is installed properly. However it is recommended that the owner inspect the unit before a seasonal start up. The coils should be free of debris so adequate airflow is achieved. The return and supply registers should be free of any obstructions. The filters should be cleaned or replaced. These few steps will help to keep the product up time to a maximum. The Service section that follows should help in identifying problems if the unit does not operate properly.

 CAUTION
<p>TO PREVENT PROPERTY DAMAGE DUE TO FIRE AND LOSS OF EQUIPMENT EFFICIENCY OR EQUIPMENT DAMAGE DUE TO DUST AND LINT BUILD UP ON INTERNAL PARTS, NEVER OPERATE UNIT WITHOUT AN AIR FILTER INSTALLED IN THE RETURN AIR SYSTEM.</p>

FILTERS

Every application may require a different frequency of replacement of dirty filters. Filters must be replaced at least every three (3) months during operating seasons.

Dirty filters are the most common cause of inadequate heating or cooling performance. Filter inspection should be made at least every two months; more often if necessary because of local conditions and usage.

Dirty throwaway filters should be discarded and replaced with a new, clean filter.

Disposable return air filters are supplied with this unit. See the unit Specification Sheet or Technical Manual for the correct size and part number. To remove the filters, remove the filter access panel on return side of the unit.

CLEAN OUTSIDE COIL (QUALIFIED SERVICER ONLY)

The coil with the outside air flowing over it should be inspected annually and cleaned as frequently as necessary to keep the finned areas free of lint, hair and debris.

LUBRICATION

The supply fan motors, the condenser fan motors and compressors are permanently lubricated.

FUNCTIONAL PARTS

Refer to the unit Parts Catalog for a list of functional parts. Parts are available from your distributor.

CABINET FINISH MAINTENANCE

Use a fine grade automotive wax on the cabinet finish to maintain the finish's original high luster. This is especially important in installations with extended periods of direct sunlight.

MAINTENANCE OF MICROCHANNEL HEAT EXCHANGERS (MCHE)

Frequent servicing is essential to maintaining the required MCHE performance. For every installed Danfoss MCHE, service records must be documented.



CAUTION

PRIOR TO SERVICING MCHE, BE SURE TO DISCONNECT THE POWER SUPPLY AND USE LOCK-OUT METHODS TO PREVENT THE POWER FROM ACCIDENTALLY BEING TURNED ON.

SHUT DOWN PERIODS

During periods when the MCHE is not operated for longer than a week, the MCHE must be completely cleaned following the cleaning procedure. This practice must also be performed during short shut-down periods where corrosive deposits accumulate on the MCHE.

CLEANING PROCEDURE

Relative to tube & fin heat exchangers, MicroChannel heat exchanger coils tend to accumulate more dirt on the surface of the coil and less dirt inside the coil, making them easier to clean. Follow the steps below for proper cleaning:

STEP 1: Remove Surface Debris

Remove surface dirt, leaves, fibers, etc. with a vacuum cleaner (preferably with a brush or other soft attachment rather than a metal tube), compressed air blown from the inside out, and/or a soft bristle (not wire!) brush. Do not impact or scrape the coil with the vacuum tube, air nozzle, etc.

STEP 2: Rinse

Rinse the coil by following procedure:

1. Rinse the coil by approved MCHE cleaner first, or rinsing by water directly;
2. Waiting for 5 minutes;
3. Wash the coil by water;

Adjust the angle of gimbaled nozzle and insert it through fans. Using an extension rod if the nozzle cannot reach the bottom side. Preferably cleaning the coils from the inside-out and top to bottom (see figure 1), running the water through every fin passage until it comes out clean. The fins of MicroChannel coils are stronger than traditional tube & fin coil fins but still need to be handled with care. Do not hit the coil with the hose. We recommend placing your thumb over the end of the hose to obtain a gentler spray and reduce the possibility of impact damage. Please **PAY MORE ATTENTION** when using a pressure cleaning equipment to prevent damage.

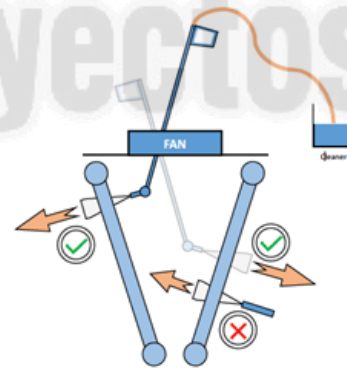

FIGURE 1

Highest pressure of cleaning equipment shall not exceed 15 bar, and tentatively move the cleaning equipment from far to near to prevent damage.

- KEEP the outlet of washer away from coil for at least 4in (see figure 2);
- KEEP the water gun perpendicular to the coil surface and the angle error shall less than 20°, or ±40° if the distance from washer to coil is more than 12in (see figure 2);
- Water outlet angle for high pressure cleaning equipment shall over 15° (see figure 3).

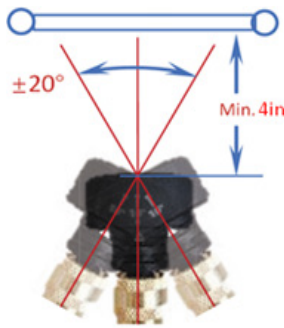

FIGURE 2



FIGURE 3

Warranty claims related to cleaning damage, especially for incorrect pressure washing operation, or corrosion resulting from applying non-recommended cleaners, will NOT be honored.

STEP 3: Remove Surface Debris

Depending on the installation and fin geometry, MicroChannel heat exchangers could possibly retain more water compared to traditional tube & fin coils. It is advised to blow off or vacuum out the residual water from the coil to speed up drying and prevent pooling. Daikin recommends a quarterly cleaning of the coils, as the minimum. The cleaning frequency should be increased depending on the level of dirt/dust accumulation and the environment (e.g., coastal areas with chlorides and salts) or industrial areas with aggressive substances.



WARNING

FIELD APPLIED COATINGS ARE NOT RECOMMENDED FOR BRAZED ALUMINUM MICROCHANNEL HEAT EXCHANGERS. MICROCHANNEL HEAT EXCHANGERS MUST NOT BE COATED USING ANY OTHER COATING, COATING OF A COIL USING A SUPPLIER OR COATING PROCESS IS NOT APPROVED AND IS NOT COVERED BY THE WARRANTY. IT MAY ALSO REDUCE THE LIFETIME AND/OR THE PERFORMANCE OF THE MICRO-CHANNEL HEAT EXCHANGER.

APPENDIX A BLOWER PERFORMANCE TABLES - AC

DFC0361D / DFC0363D DOWNSHOT					
TAP	STATIC	AIRFLOW (CFM)	RPM	WATTS	BHP
T1	0.1	1095	500	83	0.09
	0.2	910	535	98	0.10
	0.3	835	585	113	0.10
	0.4	760	635	120	0.11
	0.5	680	690	131	0.12
	0.6	570	740	141	0.13
	0.7	505	775	146	0.14
	0.8	435	820	153	0.15
T2	0.1	1390	600	197	0.20
	0.2	1300	635	210	0.21
	0.3	1240	680	219	0.23
	0.4	1180	720	228	0.24
	0.5	1120	760	239	0.25
	0.6	1055	805	251	0.27
	0.7	995	840	261	0.28
	0.8	935	880	273	0.29
T3	0.1	1400	605	203	0.21
	0.2	1320	640	215	0.22
	0.3	1255	680	224	0.23
	0.4	1200	725	233	0.25
	0.5	1140	765	245	0.26
	0.6	1075	805	257	0.27
	0.7	1015	845	267	0.29
	0.8	955	885	279	0.30
T4	0.1	1500	635	246	0.25
	0.2	1440	675	258	0.27
	0.3	1380	710	266	0.28
	0.4	1325	750	276	0.29
	0.5	1270	790	288	0.31
	0.6	1215	830	300	0.33
	0.7	1160	865	313	0.34
	0.8	1105	905	325	0.36
T5	0.1	1570	660	278	0.29
	0.2	1525	700	290	0.30
	0.3	1470	735	299	0.32
	0.4	1415	770	309	0.33
	0.5	1365	805	321	0.35
	0.6	1315	845	334	0.37
	0.7	1260	880	348	0.38
	0.8	1205	920	360	0.40

DFC0361D / DFC0363D HORIZONTAL					
TAP	STATIC	AIRFLOW (CFM)	RPM	WATTS	BHP
T1	0.1	1110	505	85	0.09
	0.2	925	540	100	0.10
	0.3	850	590	115	0.11
	0.4	770	640	122	0.11
	0.5	690	695	134	0.12
	0.6	580	745	144	0.13
	0.7	515	780	149	0.14
	0.8	440	825	156	0.15
T2	0.1	1410	605	201	0.20
	0.2	1320	640	214	0.21
	0.3	1260	685	223	0.23
	0.4	1200	725	233	0.24
	0.5	1135	765	244	0.25
	0.6	1070	810	256	0.27
	0.7	1010	845	266	0.28
	0.8	950	885	278	0.29
T3	0.1	1420	610	207	0.21
	0.2	1340	645	219	0.22
	0.3	1275	685	228	0.23
	0.4	1220	730	238	0.25
	0.5	1155	770	250	0.26
	0.6	1090	810	262	0.27
	0.7	1030	850	272	0.29
	0.8	970	890	285	0.30
T4	0.1	1520	640	251	0.25
	0.2	1460	680	263	0.27
	0.3	1400	715	271	0.28
	0.4	1345	755	282	0.30
	0.5	1290	795	294	0.31
	0.6	1235	835	306	0.33
	0.7	1175	870	319	0.34
	0.8	1120	910	332	0.36
T5	0.1	1595	665	284	0.29
	0.2	1550	705	296	0.30
	0.3	1490	740	305	0.32
	0.4	1435	775	315	0.33
	0.5	1385	810	327	0.35
	0.6	1335	850	341	0.37
	0.7	1280	885	355	0.38
	0.8	1225	925	367	0.40

APPENDIX A BLOWER PERFORMANCE TABLES - AC

DFC0364D / DFC0367D DOWNSHOT					
TAP	STATIC	AIRFLOW (CFM)	RPM	WATTS	BHP
T1	0.1	980	480	80	0.09
	0.2	910	535	88	0.10
	0.3	840	580	96	0.10
	0.4	795	615	102	0.11
	0.5	735	655	110	0.12
	0.6	660	705	119	0.13
	0.7	580	755	129	0.14
	0.8	500	805	139	0.15
T2	0.1	1365	600	190	0.20
	0.2	1305	640	202	0.21
	0.3	1245	685	214	0.23
	0.4	1195	720	224	0.24
	0.5	1145	755	235	0.25
	0.6	1090	790	245	0.26
	0.7	1030	830	256	0.28
	0.8	970	870	267	0.29
T3	0.1	1385	605	198	0.21
	0.2	1325	650	210	0.22
	0.3	1270	690	222	0.24
	0.4	1220	725	232	0.25
	0.5	1170	760	243	0.26
	0.6	1115	795	253	0.27
	0.7	1055	835	265	0.29
	0.8	995	875	275	0.30
T4	0.1	1485	640	235	0.28
	0.2	1430	680	248	0.29
	0.3	1375	715	261	0.31
	0.4	1325	750	272	0.32
	0.5	1280	785	284	0.34
	0.6	1225	820	295	0.36
	0.7	1175	855	306	0.37
	0.8	1120	890	317	0.39
T5	0.1	1575	665	270	0.29
	0.2	1525	705	284	0.31
	0.3	1470	740	298	0.32
	0.4	1420	775	310	0.34
	0.5	1375	810	322	0.35
	0.6	1325	845	334	0.37
	0.7	1275	875	346	0.38
	0.8	1230	910	357	0.39

DFC0364D / DFC0367D HORIZONTAL					
TAP	STATIC	AIRFLOW (CFM)	RPM	WATTS	BHP
T1	0.1	965	485	81	0.09
	0.2	895	545	89	0.10
	0.3	825	590	97	0.11
	0.4	785	625	104	0.11
	0.5	725	665	112	0.12
	0.6	650	715	121	0.13
	0.7	570	765	131	0.14
	0.8	495	815	141	0.15
T2	0.1	1345	610	193	0.20
	0.2	1285	650	205	0.22
	0.3	1225	695	217	0.23
	0.4	1175	730	227	0.24
	0.5	1130	765	239	0.25
	0.6	1075	800	249	0.27
	0.7	1015	840	260	0.28
	0.8	955	885	271	0.29
T3	0.1	1365	615	201	0.21
	0.2	1305	660	213	0.23
	0.3	1250	700	225	0.24
	0.4	1200	735	235	0.25
	0.5	1150	770	247	0.26
	0.6	1100	805	257	0.28
	0.7	1040	850	269	0.29
	0.8	980	890	279	0.31
T4	0.1	1465	650	239	0.28
	0.2	1410	690	252	0.30
	0.3	1355	725	265	0.31
	0.4	1305	760	276	0.33
	0.5	1260	795	288	0.34
	0.6	1205	830	299	0.36
	0.7	1155	870	311	0.38
	0.8	1105	905	322	0.39
T5	0.1	1550	675	274	0.29
	0.2	1500	715	288	0.31
	0.3	1450	750	302	0.32
	0.4	1400	785	315	0.34
	0.5	1355	820	327	0.36
	0.6	1305	860	339	0.37
	0.7	1255	890	351	0.39
	0.8	1210	925	362	0.40

APPENDIX A BLOWER PERFORMANCE TABLES - AC

DFC0363W / DFC0364W / DFC0367W DOWNSHOT					
TAP	STATIC	AIRFLOW (CFM)	RPM	WATTS	BHP
T1	0.8	1285	920	379	0.42
	0.9	1235	950	391	0.43
	1.0	1185	980	403	0.45
	1.1	1100	1020	416	0.47
	1.2	1050	1050	429	0.48
	1.3	1000	1085	442	0.50
	1.4	950	1115	453	0.51
	1.5	900	1145	466	0.52
	1.6	845	1180	478	0.54
	1.7	790	1205	489	0.55
1.8	750	1230	498	0.56	
T2	0.8	1375	935	416	0.46
	0.9	1325	965	428	0.48
	1.0	1280	995	440	0.49
	1.1	1200	1030	454	0.51
	1.2	1150	1060	468	0.52
	1.3	1100	1095	481	0.54
	1.4	1050	1120	493	0.55
	1.5	1000	1155	506	0.57
	1.6	945	1185	520	0.59
	1.7	895	1215	531	0.60
1.8	850	1240	542	0.61	
T3	0.8	1415	940	435	0.48
	0.9	1370	970	447	0.50
	1.0	1325	1000	460	0.51
	1.1	1250	1035	474	0.53
	1.2	1200	1065	487	0.55
	1.3	1150	1100	501	0.57
	1.4	1095	1125	513	0.58
	1.5	1050	1155	526	0.59
	1.6	995	1190	541	0.61
	1.7	940	1215	552	0.62
1.8	895	1245	564	0.64	
T4	0.8	1500	955	474	0.53
	0.9	1455	985	486	0.54
	1.0	1410	1015	499	0.56
	1.1	1340	1045	514	0.58
	1.2	1290	1075	528	0.59
	1.3	1240	1105	542	0.61
	1.4	1190	1135	554	0.63
	1.5	1145	1165	568	0.64
	1.6	1090	1195	584	0.66
	1.7	1040	1225	595	0.68
1.8	990	1255	609	0.69	
T5	0.8	1540	965	494	0.55
	0.9	1495	990	506	0.57
	1.0	1455	1020	520	0.58
	1.1	1385	1050	534	0.60
	1.2	1335	1080	548	0.62
	1.3	1290	1110	563	0.63
	1.4	1235	1140	575	0.65
	1.5	1195	1170	589	0.67
	1.6	1135	1200	605	0.69
	1.7	1085	1230	617	0.70
1.8	1040	1260	631	0.72	

DFC0363W / DFC0364W / DFC0367W DOWNSHOT					
TAP	STATIC	AIRFLOW (CFM)	RPM	WATTS	BHP
T1'	0.8	1500	955	474	0.53
	0.9	1455	985	486	0.54
	1.0	1410	1015	499	0.56
	1.1	1340	1045	514	0.58
	1.2	1290	1075	528	0.59
	1.3	1240	1105	542	0.61
	1.4	1190	1135	554	0.63
	1.5	1145	1165	568	0.64
	1.6	1090	1195	584	0.66
	1.7	1040	1225	595	0.68
1.8	990	1255	609	0.69	
T2'	0.8	1600	975	525	0.58
	0.9	1555	1000	537	0.60
	1.0	1515	1030	551	0.62
	1.1	1450	1060	565	0.64
	1.2	1400	1090	580	0.65
	1.3	1355	1120	594	0.67
	1.4	1300	1145	607	0.69
	1.5	1260	1175	622	0.70
	1.6	1205	1205	638	0.72
	1.7	1155	1235	650	0.74
1.8	1105	1265	665	0.76	
T3'	0.8	1635	985	545	0.61
	0.9	1595	1010	558	0.63
	1.0	1555	1035	572	0.64
	1.1	1490	1065	586	0.66
	1.2	1440	1095	601	0.68
	1.3	1395	1125	615	0.70
	1.4	1345	1150	628	0.71
	1.5	1305	1180	644	0.73
	1.6	1250	1210	660	0.75
	1.7	1200	1235	673	0.76
1.8	1150	1270	688	0.79	
T4'	0.8	1710	1000	587	0.66
	0.9	1670	1025	600	0.67
	1.0	1630	1050	615	0.69
	1.1	1570	1075	629	0.71
	1.2	1520	1105	644	0.73
	1.3	1480	1135	659	0.75
	1.4	1425	1160	672	0.76
	1.5	1390	1185	688	0.78
	1.6	1335	1220	705	0.80
	1.7	1285	1245	718	0.82
1.8	1240	1275	734	0.84	
T5'	0.8	1750	1010	614	0.69
	0.9	1715	1030	628	0.70
	1.0	1675	1060	642	0.72
	1.1	1615	1085	656	0.74
	1.2	1570	1115	672	0.76
	1.3	1525	1140	687	0.78
	1.4	1475	1165	700	0.79
	1.5	1440	1190	716	0.81
	1.6	1390	1225	733	0.83
	1.7	1340	1250	747	0.85
1.8	1290	1280	764	0.87	

APPENDIX A BLOWER PERFORMANCE TABLES - AC

DFC0363W / DFC0364W / DFC0367W HORIZONTAL					
TAP	STATIC	AIRFLOW (CFM)	RPM	WATTS	BHP
T1	0.8	1265	935	385	0.43
	0.9	1215	965	397	0.44
	1.0	1165	995	409	0.45
	1.1	1085	1035	422	0.47
	1.2	1035	1065	435	0.49
	1.3	985	1100	449	0.50
	1.4	935	1130	460	0.52
	1.5	885	1160	473	0.53
	1.6	830	1200	485	0.55
	1.7	780	1225	496	0.56
1.8	740	1250	505	0.57	
T2	0.8	1355	950	422	0.47
	0.9	1305	980	434	0.49
	1.0	1260	1010	447	0.50
	1.1	1180	1045	461	0.52
	1.2	1135	1075	475	0.53
	1.3	1085	1110	488	0.55
	1.4	1035	1135	500	0.56
	1.5	985	1170	514	0.58
	1.6	930	1205	528	0.60
	1.7	880	1235	539	0.61
1.8	835	1260	550	0.62	
T3	0.8	1395	955	442	0.49
	0.9	1350	985	454	0.51
	1.0	1305	1015	467	0.52
	1.1	1230	1050	481	0.54
	1.2	1180	1080	494	0.56
	1.3	1135	1115	509	0.57
	1.4	1080	1140	521	0.59
	1.5	1035	1170	534	0.60
	1.6	980	1210	549	0.62
	1.7	925	1235	560	0.63
1.8	880	1265	572	0.65	
T4	0.8	1480	970	481	0.54
	0.9	1435	1000	493	0.55
	1.0	1390	1030	506	0.57
	1.1	1320	1060	522	0.59
	1.2	1270	1090	536	0.60
	1.3	1220	1120	550	0.62
	1.4	1170	1150	562	0.63
	1.5	1130	1180	577	0.65
	1.6	1075	1215	593	0.67
	1.7	1025	1245	604	0.69
1.8	975	1275	618	0.70	
T5	0.8	1515	980	501	0.56
	0.9	1475	1005	514	0.57
	1.0	1435	1035	528	0.59
	1.1	1365	1065	542	0.61
	1.2	1315	1095	556	0.63
	1.3	1270	1125	571	0.64
	1.4	1215	1155	584	0.66
	1.5	1175	1190	598	0.68
	1.6	1120	1220	614	0.70
	1.7	1070	1250	626	0.71
1.8	1025	1280	640	0.73	

DFC0363W / DFC0364W / DFC0367W HORIZONTAL					
TAP	STATIC	AIRFLOW (CFM)	RPM	WATTS	BHP
T1'	0.8	1480	970	481	0.54
	0.9	1435	1000	493	0.55
	1.0	1390	1030	506	0.57
	1.1	1320	1060	522	0.59
	1.2	1270	1090	536	0.60
	1.3	1220	1120	550	0.62
	1.4	1170	1150	562	0.63
	1.5	1130	1180	577	0.65
	1.6	1075	1215	593	0.67
	1.7	1025	1245	604	0.69
1.8	975	1275	618	0.70	
T2'	0.8	1575	990	533	0.59
	0.9	1530	1015	545	0.61
	1.0	1490	1045	559	0.63
	1.1	1430	1075	573	0.64
	1.2	1380	1105	589	0.66
	1.3	1335	1135	603	0.68
	1.4	1280	1160	616	0.70
	1.5	1240	1195	631	0.72
	1.6	1185	1225	648	0.73
	1.7	1140	1255	660	0.75
1.8	1090	1285	675	0.77	
T3'	0.8	1610	1000	553	0.62
	0.9	1570	1025	566	0.63
	1.0	1530	1050	581	0.65
	1.1	1470	1080	595	0.67
	1.2	1420	1110	610	0.69
	1.3	1375	1140	624	0.71
	1.4	1325	1165	637	0.72
	1.5	1285	1200	654	0.74
	1.6	1230	1230	670	0.76
	1.7	1180	1255	683	0.78
1.8	1135	1290	698	0.80	
T4'	0.8	1685	1015	596	0.67
	0.9	1645	1040	609	0.68
	1.0	1605	1065	624	0.70
	1.1	1545	1090	638	0.72
	1.2	1495	1120	654	0.74
	1.3	1460	1150	669	0.76
	1.4	1405	1175	682	0.77
	1.5	1370	1205	698	0.79
	1.6	1315	1240	716	0.81
	1.7	1265	1265	729	0.83
1.8	1220	1295	745	0.85	
T5'	0.8	1725	1025	623	0.70
	0.9	1690	1045	637	0.71
	1.0	1650	1075	652	0.73
	1.1	1590	1100	666	0.75
	1.2	1545	1130	682	0.77
	1.3	1500	1155	697	0.79
	1.4	1455	1180	710	0.80
	1.5	1420	1210	727	0.82
	1.6	1370	1245	744	0.85
	1.7	1320	1270	758	0.86
1.8	1270	1300	775	0.88	

APPENDIX A BLOWER PERFORMANCE TABLES - AC

DFC0481D / DFC0483D DOWNSHOT					
TAP	STATIC	AIRFLOW (CFM)	RPM	WATTS	BHP
T1	0.1	1275	585	176	0.18
	0.2	1205	635	186	0.19
	0.3	1145	675	196	0.21
	0.4	1070	720	210	0.22
	0.5	1000	765	220	0.23
	0.6	935	805	231	0.25
	0.7	870	845	243	0.26
	0.8	825	890	246	0.27
T2	0.1	1780	750	384	0.42
	0.2	1725	780	401	0.44
	0.3	1675	815	417	0.46
	0.4	1630	845	431	0.47
	0.5	1575	880	446	0.49
	0.6	1520	910	459	0.51
	0.7	1465	945	473	0.53
	0.8	1405	980	491	0.55
T3	0.1	1805	755	398	0.43
	0.2	1755	790	414	0.46
	0.3	1700	820	430	0.47
	0.4	1655	850	445	0.49
	0.5	1605	885	460	0.51
	0.6	1550	915	473	0.53
	0.7	1495	950	487	0.55
	0.8	1435	985	506	0.57
T4	0.1	1900	785	448	0.49
	0.2	1850	815	465	0.51
	0.3	1800	845	482	0.53
	0.4	1755	875	496	0.55
	0.5	1705	905	512	0.57
	0.6	1650	935	525	0.59
	0.7	1600	970	541	0.61
	0.8	1540	1000	560	0.63
T5	0.1	1995	815	505	0.56
	0.2	1950	845	523	0.58
	0.3	1900	875	540	0.60
	0.4	1860	900	555	0.62
	0.5	1810	930	570	0.64
	0.6	1755	960	585	0.66
	0.7	1710	990	601	0.68
	0.8	1650	1020	622	0.70

DFC0481D / DFC0483D HORIZONTAL					
TAP	STATIC	AIRFLOW (CFM)	RPM	WATTS	BHP
T1	0.1	1235	610	185	0.19
	0.2	1170	660	195	0.20
	0.3	1110	700	206	0.21
	0.4	1040	750	221	0.23
	0.5	970	795	231	0.24
	0.6	905	835	243	0.25
	0.7	845	880	255	0.27
	0.8	800	925	258	0.28
T2	0.1	1725	780	403	0.44
	0.2	1675	810	421	0.45
	0.3	1625	850	438	0.48
	0.4	1580	880	453	0.49
	0.5	1530	915	468	0.51
	0.6	1475	945	482	0.53
	0.7	1420	985	497	0.55
	0.8	1365	1020	516	0.57
T3	0.1	1750	785	418	0.45
	0.2	1700	820	435	0.47
	0.3	1650	855	452	0.49
	0.4	1605	885	467	0.51
	0.5	1555	920	483	0.53
	0.6	1505	950	497	0.55
	0.7	1450	990	511	0.57
	0.8	1390	1025	531	0.59
T4	0.1	1845	815	470	0.51
	0.2	1795	850	488	0.53
	0.3	1745	880	506	0.55
	0.4	1700	910	521	0.57
	0.5	1655	940	538	0.59
	0.6	1600	970	551	0.61
	0.7	1550	1010	568	0.63
	0.8	1495	1040	588	0.65
T5	0.1	1935	850	530	0.58
	0.2	1890	880	549	0.60
	0.3	1845	910	567	0.62
	0.4	1805	935	583	0.64
	0.5	1755	965	599	0.66
	0.6	1700	1000	614	0.69
	0.7	1660	1030	631	0.71
	0.8	1600	1060	653	0.73

APPENDIX A BLOWER PERFORMANCE TABLES - AC

DFC0484D / DFC0487D DOWNSHOT					
TAP	STATIC	AIRFLOW (CFM)	RPM	WATTS	BHP
T1	0.1	1265	595	174	0.18
	0.2	1205	640	185	0.19
	0.3	1140	680	196	0.21
	0.4	1060	725	208	0.22
	0.5	990	765	220	0.23
	0.6	925	805	230	0.25
	0.7	850	840	239	0.26
	0.8	785	885	250	0.27
T2	0.1	1775	755	383	0.42
	0.2	1730	785	398	0.43
	0.3	1680	820	414	0.45
	0.4	1630	850	428	0.47
	0.5	1580	885	442	0.49
	0.6	1530	915	456	0.51
	0.7	1470	950	472	0.52
	0.8	1415	980	486	0.54
T3	0.1	1765	750	379	0.41
	0.2	1720	785	394	0.43
	0.3	1670	820	409	0.45
	0.4	1620	850	423	0.47
	0.5	1570	880	437	0.48
	0.6	1515	915	451	0.50
	0.7	1460	950	467	0.52
	0.8	1405	980	481	0.54
T4	0.1	1860	785	430	0.47
	0.2	1820	815	446	0.49
	0.3	1770	845	462	0.51
	0.4	1725	875	476	0.52
	0.5	1675	905	491	0.54
	0.6	1625	935	505	0.56
	0.7	1575	970	522	0.58
	0.8	1520	1000	537	0.60
T5	0.1	1945	810	479	0.52
	0.2	1900	840	495	0.54
	0.3	1855	870	511	0.56
	0.4	1815	895	526	0.58
	0.5	1770	925	541	0.60
	0.6	1720	955	556	0.62
	0.7	1670	990	573	0.64
	0.8	1620	1015	589	0.66

DFC0484D / DFC0487D HORIZONTAL					
TAP	STATIC	AIRFLOW (CFM)	RPM	WATTS	BHP
T1	0.1	1250	615	179	0.19
	0.2	1195	660	191	0.20
	0.3	1130	700	202	0.21
	0.4	1050	745	214	0.23
	0.5	980	790	227	0.24
	0.6	915	830	237	0.25
	0.7	840	865	246	0.26
	0.8	775	910	258	0.28
T2	0.1	1755	780	394	0.43
	0.2	1715	810	410	0.45
	0.3	1665	845	426	0.47
	0.4	1615	875	441	0.48
	0.5	1565	910	455	0.50
	0.6	1515	940	470	0.52
	0.7	1455	980	486	0.54
	0.8	1400	1010	501	0.56
T3	0.1	1745	775	390	0.42
	0.2	1705	810	406	0.44
	0.3	1655	845	421	0.46
	0.4	1605	875	436	0.48
	0.5	1555	905	450	0.50
	0.6	1500	940	465	0.51
	0.7	1445	980	481	0.54
	0.8	1390	1010	495	0.55
T4	0.1	1840	810	443	0.49
	0.2	1800	840	459	0.50
	0.3	1750	870	476	0.52
	0.4	1710	900	490	0.54
	0.5	1660	930	506	0.56
	0.6	1610	965	520	0.58
	0.7	1560	1000	538	0.60
	0.8	1505	1030	553	0.62
T5	0.1	1925	835	493	0.54
	0.2	1880	865	510	0.56
	0.3	1835	895	526	0.58
	0.4	1795	920	542	0.60
	0.5	1750	955	557	0.62
	0.6	1705	985	573	0.64
	0.7	1655	1020	590	0.66
	0.8	1605	1045	607	0.68

APPENDIX A BLOWER PERFORMANCE TABLES - AC

DFC0483W / DFC0484W / DFC0487W DOWNSHOT					
TAP	STATIC	AIRFLOW (CFM)	RPM	WATTS	BHP
T1	0.8	1560	1005	557	0.62
	0.9	1505	1040	572	0.64
	1.0	1450	1065	587	0.66
	1.1	1390	1095	602	0.68
	1.2	1345	1125	614	0.70
	1.3	1305	1145	626	0.71
	1.4	1250	1175	642	0.73
	1.5	1205	1200	654	0.74
	1.6	1175	1220	664	0.75
	1.7	1130	1245	678	0.77
1.8	1100	1265	684	0.78	
T2	0.8	1810	1055	703	0.79
	0.9	1755	1080	719	0.81
	1.0	1705	1110	736	0.83
	1.1	1645	1135	754	0.85
	1.2	1600	1165	771	0.87
	1.3	1555	1190	787	0.89
	1.4	1505	1215	803	0.91
	1.5	1465	1240	815	0.93
	1.6	1425	1260	828	0.94
	1.7	1385	1285	843	0.96
1.8	1355	1300	851	0.97	
T3	0.8	1825	1055	714	0.80
	0.9	1775	1085	731	0.82
	1.0	1720	1110	748	0.84
	1.1	1665	1140	766	0.86
	1.2	1620	1170	783	0.89
	1.3	1575	1195	799	0.90
	1.4	1525	1220	815	0.92
	1.5	1480	1240	827	0.94
	1.6	1445	1260	841	0.95
	1.7	1405	1285	856	0.97
1.8	1375	1300	864	0.98	
T4	0.8	1930	1075	789	0.88
	0.9	1880	1105	806	0.90
	1.0	1835	1130	823	0.93
	1.1	1780	1155	843	0.95
	1.2	1730	1185	863	0.97
	1.3	1685	1210	881	0.99
	1.4	1635	1240	897	1.02
	1.5	1595	1260	910	1.03
	1.6	1550	1280	925	1.05
	1.7	1510	1305	940	1.07
1.8	1480	1320	952	1.08	
T5	0.8	1960	1085	813	0.91
	0.9	1915	1110	829	0.93
	1.0	1865	1135	847	0.95
	1.1	1815	1160	868	0.97
	1.2	1765	1190	889	1.00
	1.3	1715	1220	907	1.02
	1.4	1665	1245	923	1.04
	1.5	1625	1265	936	1.06
	1.6	1585	1285	952	1.08
	1.7	1545	1310	967	1.10
1.8	1510	1325	980	1.11	

DFC0483W / DFC0484W / DFC0487W DOWNSHOT					
TAP	STATIC	AIRFLOW (CFM)	RPM	WATTS	BHP
T1'	0.8	1750	1040	664	0.74
	0.9	1695	1070	680	0.76
	1.0	1640	1100	697	0.79
	1.1	1580	1125	713	0.80
	1.2	1535	1155	729	0.82
	1.3	1495	1180	744	0.84
	1.4	1445	1205	760	0.86
	1.5	1400	1230	772	0.88
	1.6	1365	1250	784	0.89
	1.7	1325	1275	799	0.91
1.8	1295	1290	806	0.92	
T2'	0.8	2020	1095	861	0.96
	0.9	1975	1120	877	0.98
	1.0	1935	1145	895	1.00
	1.1	1880	1170	917	1.02
	1.2	1830	1200	940	1.05
	1.3	1780	1230	959	1.08
	1.4	1730	1255	975	1.10
	1.5	1690	1275	988	1.12
	1.6	1645	1295	1006	1.13
	1.7	1605	1320	1020	1.16
1.8	1570	1340	1036	1.17	
T3'	0.8	2035	1100	873	0.97
	0.9	1990	1125	889	1.00
	1.0	1950	1145	907	1.01
	1.1	1900	1175	930	1.04
	1.2	1845	1205	952	1.07
	1.3	1795	1230	972	1.09
	1.4	1745	1255	988	1.11
	1.5	1705	1275	1001	1.13
	1.6	1660	1300	1019	1.15
	1.7	1620	1320	1034	1.17
1.8	1585	1340	1051	1.19	
T4'	0.8	2125	1120	960	1.07
	0.9	2090	1140	976	1.09
	1.0	2060	1165	994	1.11
	1.1	2015	1190	1019	1.13
	1.2	1955	1220	1045	1.16
	1.3	1895	1250	1067	1.19
	1.4	1845	1275	1083	1.21
	1.5	1805	1295	1096	1.23
	1.6	1755	1320	1117	1.26
	1.7	1715	1340	1130	1.28
1.8	1670	1365	1154	1.30	
T5'	0.8	2125	1120	960	1.07
	0.9	2090	1140	976	1.09
	1.0	2060	1165	994	1.11
	1.1	2015	1190	1019	1.13
	1.2	1955	1220	1045	1.16
	1.3	1895	1250	1067	1.19
	1.4	1845	1275	1083	1.21
	1.5	1805	1295	1096	1.23
	1.6	1755	1320	1117	1.26
	1.7	1715	1340	1130	1.28
1.8	1670	1365	1154	1.30	

APPENDIX A BLOWER PERFORMANCE TABLES - AC

DFC0483W / DFC0484W / DFC0487W HORIZONTAL					
TAP	STATIC	AIRFLOW (CFM)	RPM	WATTS	BHP
T1	0.8	1545	1035	574	0.64
	0.9	1490	1070	589	0.66
	1.0	1435	1095	605	0.68
	1.1	1375	1130	620	0.70
	1.2	1330	1160	632	0.72
	1.3	1290	1180	645	0.73
	1.4	1240	1210	661	0.75
	1.5	1195	1235	674	0.76
	1.6	1165	1255	684	0.78
	1.7	1120	1280	698	0.79
1.8	1090	1305	705	0.81	
T2	0.8	1790	1085	724	0.81
	0.9	1735	1110	741	0.83
	1.0	1690	1145	758	0.86
	1.1	1630	1170	777	0.87
	1.2	1585	1200	794	0.90
	1.3	1540	1225	811	0.92
	1.4	1490	1250	827	0.93
	1.5	1450	1275	839	0.95
	1.6	1410	1300	853	0.97
	1.7	1370	1325	868	0.99
1.8	1340	1340	877	1.00	
T3	0.8	1805	1085	735	0.82
	0.9	1755	1120	753	0.85
	1.0	1705	1145	770	0.87
	1.1	1650	1175	789	0.89
	1.2	1605	1205	806	0.91
	1.3	1560	1230	823	0.93
	1.4	1510	1255	839	0.95
	1.5	1465	1275	852	0.96
	1.6	1430	1300	866	0.98
	1.7	1390	1325	882	1.00
1.8	1360	1340	890	1.01	
T4	0.8	1910	1105	813	0.90
	0.9	1860	1140	830	0.93
	1.0	1815	1165	848	0.95
	1.1	1760	1190	868	0.97
	1.2	1715	1220	889	1.00
	1.3	1670	1245	907	1.02
	1.4	1620	1275	924	1.04
	1.5	1580	1300	937	1.06
	1.6	1535	1320	953	1.08
	1.7	1495	1345	968	1.10
1.8	1465	1360	981	1.11	
T5	0.8	1940	1120	837	0.94
	0.9	1895	1145	854	0.96
	1.0	1845	1170	872	0.98
	1.1	1795	1195	894	1.00
	1.2	1745	1225	916	1.03
	1.3	1700	1255	934	1.05
	1.4	1650	1280	951	1.07
	1.5	1610	1305	964	1.09
	1.6	1570	1325	981	1.11
	1.7	1530	1350	996	1.13
1.8	1495	1365	1009	1.14	

DFC0483W / DFC0484W / DFC0487W HORIZONTAL					
TAP	STATIC	AIRFLOW (CFM)	RPM	WATTS	BHP
T1'	0.8	1735	1070	684	0.76
	0.9	1680	1100	700	0.79
	1.0	1625	1135	718	0.81
	1.1	1565	1160	734	0.83
	1.2	1520	1190	751	0.85
	1.3	1480	1215	766	0.87
	1.4	1430	1240	783	0.89
	1.5	1385	1265	795	0.90
	1.6	1350	1290	808	0.92
	1.7	1310	1315	823	0.94
1.8	1280	1330	830	0.95	
T2'	0.8	2000	1130	887	0.99
	0.9	1955	1155	903	1.01
	1.0	1915	1180	922	1.03
	1.1	1860	1205	945	1.06
	1.2	1810	1235	968	1.08
	1.3	1760	1265	988	1.11
	1.4	1715	1295	1004	1.13
	1.5	1675	1315	1018	1.15
	1.6	1630	1335	1036	1.17
	1.7	1590	1360	1051	1.19
1.8	1555	1380	1067	1.21	
T3'	0.8	2015	1135	899	1.00
	0.9	1970	1160	916	1.03
	1.0	1930	1180	934	1.04
	1.1	1880	1210	958	1.07
	1.2	1825	1240	981	1.10
	1.3	1775	1265	1001	1.12
	1.4	1730	1295	1018	1.15
	1.5	1690	1315	1031	1.16
	1.6	1645	1340	1050	1.19
	1.7	1605	1360	1065	1.20
1.8	1570	1380	1083	1.22	
T4'	0.8	2105	1155	989	1.10
	0.9	2070	1175	1005	1.12
	1.0	2040	1200	1024	1.14
	1.1	1995	1225	1050	1.17
	1.2	1935	1255	1076	1.19
	1.3	1875	1290	1099	1.23
	1.4	1825	1315	1115	1.25
	1.5	1785	1335	1129	1.27
	1.6	1735	1360	1151	1.29
	1.7	1700	1380	1164	1.31
1.8	1655	1405	1189	1.34	
T5'	0.8	2105	1155	989	1.10
	0.9	2070	1175	1005	1.12
	1.0	2040	1200	1024	1.14
	1.1	1995	1225	1050	1.17
	1.2	1935	1255	1076	1.19
	1.3	1875	1290	1099	1.23
	1.4	1825	1315	1115	1.25
	1.5	1785	1335	1129	1.27
	1.6	1735	1360	1151	1.29
	1.7	1700	1380	1164	1.31
1.8	1655	1405	1189	1.34	

APPENDIX A BLOWER PERFORMANCE TABLES - AC

DFC0601D / DFC0603D DOWNSHOT					
TAP	STATIC	AIRFLOW (CFM)	RPM	WATTS	BHP
T1	0.1	1565	680	285	0.30
	0.2	1505	720	299	0.32
	0.3	1450	755	313	0.34
	0.4	1395	790	327	0.35
	0.5	1335	830	340	0.37
	0.6	1275	865	352	0.39
	0.7	1215	900	365	0.40
	0.8	1160	940	378	0.42
	0.9	1105	975	391	0.44
	1.0	1065	1010	407	0.45
T2	0.1	1880	780	438	0.48
	0.2	1830	810	456	0.50
	0.3	1780	845	472	0.52
	0.4	1735	870	487	0.54
	0.5	1685	905	502	0.56
	0.6	1630	935	516	0.58
	0.7	1580	965	531	0.60
	0.8	1520	1000	550	0.62
	0.9	1470	1035	570	0.64
	1.0	1415	1070	588	0.66
T3	0.1	2090	845	566	0.63
	0.2	2045	870	583	0.65
	0.3	2000	900	600	0.67
	0.4	1955	925	615	0.69
	0.5	1905	955	632	0.71
	0.6	1855	985	647	0.73
	0.7	1810	1010	664	0.75
	0.8	1755	1040	685	0.77
	0.9	1705	1075	704	0.80
	1.0	1645	1105	723	0.82
T4	0.1	2010	820	515	0.57
	0.2	1965	850	533	0.59
	0.3	1915	880	549	0.61
	0.4	1875	905	565	0.63
	0.5	1825	935	580	0.65
	0.6	1775	965	595	0.67
	0.7	1725	995	611	0.69
	0.8	1670	1025	632	0.71
	0.9	1615	1060	652	0.74
	1.0	1560	1090	671	0.76
T5	0.1	2310	910	729	0.81
	0.2	2270	935	744	0.83
	0.3	2225	960	761	0.85
	0.4	2180	985	777	0.87
	0.5	2125	1015	794	0.90
	0.6	2080	1040	813	0.92
	0.7	2040	1065	831	0.94
	0.8	2000	1090	850	0.97
	0.9	1950	1115	864	0.99
	1.0	1895	1145	882	1.01

DFC0601D / DFC0603D HORIZONTAL					
TAP	STATIC	AIRFLOW (CFM)	RPM	WATTS	BHP
T1	0.1	1520	705	299	0.32
	0.2	1460	750	314	0.34
	0.3	1405	785	329	0.35
	0.4	1355	820	343	0.37
	0.5	1295	865	357	0.39
	0.6	1235	900	370	0.40
	0.7	1180	935	383	0.42
	0.8	1125	980	397	0.44
	0.9	1070	1015	411	0.45
	1.0	1035	1050	427	0.47
T2	0.1	1825	810	460	0.50
	0.2	1775	840	479	0.52
	0.3	1725	880	496	0.54
	0.4	1685	905	511	0.56
	0.5	1635	940	527	0.58
	0.6	1580	970	542	0.60
	0.7	1535	1005	558	0.62
	0.8	1475	1040	578	0.64
	0.9	1425	1075	599	0.67
	1.0	1375	1115	617	0.69
T3	0.1	2025	880	594	0.65
	0.2	1985	905	612	0.67
	0.3	1940	935	630	0.69
	0.4	1895	960	646	0.71
	0.5	1850	995	664	0.74
	0.6	1800	1025	679	0.76
	0.7	1755	1050	697	0.78
	0.8	1700	1080	719	0.80
	0.9	1655	1120	739	0.83
	1.0	1595	1150	759	0.85
T4	0.1	1950	855	541	0.59
	0.2	1905	885	560	0.62
	0.3	1860	915	576	0.64
	0.4	1820	940	593	0.65
	0.5	1770	970	609	0.67
	0.6	1720	1005	625	0.70
	0.7	1675	1035	642	0.72
	0.8	1620	1065	664	0.74
	0.9	1565	1100	685	0.76
	1.0	1515	1135	705	0.79
T5	0.1	2240	945	765	0.84
	0.2	2200	970	781	0.86
	0.3	2160	1000	799	0.89
	0.4	2115	1025	816	0.91
	0.5	2060	1055	834	0.93
	0.6	2020	1080	854	0.96
	0.7	1980	1110	873	0.98
	0.8	1940	1135	893	1.00
	0.9	1890	1160	907	1.03
	1.0	1840	1190	926	1.05

APPENDIX A BLOWER PERFORMANCE TABLES - AC

DFC0604D / DFC0607D DOWNSHOT					
TAP	STATIC	AIRFLOW (CFM)	RPM	WATTS	BHP
T1	0.1	1555	685	280	0.30
	0.2	1500	720	293	0.32
	0.3	1445	760	307	0.33
	0.4	1385	795	320	0.35
	0.5	1325	830	333	0.36
	0.6	1265	865	346	0.38
	0.7	1205	900	359	0.39
	0.8	1145	935	372	0.41
	0.9	1095	970	384	0.42
	1.0	1050	1000	394	0.44
T2	0.1	1860	785	430	0.47
	0.2	1820	815	446	0.49
	0.3	1770	845	462	0.51
	0.4	1725	875	476	0.52
	0.5	1675	905	491	0.54
	0.6	1625	935	505	0.56
	0.7	1575	970	522	0.58
	0.8	1520	1000	537	0.60
	0.9	1465	1030	552	0.62
	1.0	1410	1060	566	0.64
T3	0.1	2080	855	572	0.63
	0.2	2045	880	589	0.65
	0.3	2000	910	605	0.67
	0.4	1960	935	621	0.69
	0.5	1920	965	637	0.71
	0.6	1875	990	653	0.73
	0.7	1830	1020	670	0.75
	0.8	1785	1050	686	0.77
	0.9	1730	1075	703	0.79
	1.0	1675	1105	719	0.81
T4	0.1	1990	825	509	0.58
	0.2	1950	855	525	0.60
	0.3	1905	885	542	0.62
	0.4	1865	910	557	0.64
	0.5	1820	940	572	0.66
	0.6	1775	970	588	0.68
	0.7	1725	1000	605	0.70
	0.8	1675	1025	621	0.72
	0.9	1620	1055	636	0.74
	1.0	1565	1085	652	0.76
T5	0.1	2270	920	730	0.82
	0.2	2235	945	747	0.85
	0.3	2195	970	764	0.87
	0.4	2155	995	782	0.89
	0.5	2120	1020	799	0.91
	0.6	2080	1045	815	0.94
	0.7	2045	1070	832	0.96
	0.8	2005	1095	849	0.98
	0.9	1960	1120	865	1.00
	1.0	1915	1140	883	1.02

DFC0604D / DFC0607D HORIZONTAL					
TAP	STATIC	AIRFLOW (CFM)	RPM	WATTS	BHP
T1	0.1	1540	705	288	0.31
	0.2	1485	740	302	0.32
	0.3	1430	785	316	0.34
	0.4	1370	820	330	0.36
	0.5	1310	855	343	0.37
	0.6	1250	890	356	0.39
	0.7	1195	925	370	0.41
	0.8	1135	965	383	0.42
	0.9	1085	1000	396	0.44
	1.0	1040	1030	406	0.45
T2	0.1	1840	810	443	0.49
	0.2	1800	840	459	0.50
	0.3	1750	870	476	0.52
	0.4	1710	900	490	0.54
	0.5	1660	930	506	0.56
	0.6	1610	965	520	0.58
	0.7	1560	1000	538	0.60
	0.8	1505	1030	553	0.62
	0.9	1450	1060	569	0.64
	1.0	1395	1090	583	0.65
T3	0.1	2060	880	589	0.65
	0.2	2025	905	607	0.66
	0.3	1980	935	623	0.69
	0.4	1940	965	640	0.71
	0.5	1900	995	656	0.73
	0.6	1855	1020	673	0.75
	0.7	1810	1050	690	0.77
	0.8	1765	1080	707	0.79
	0.9	1715	1105	724	0.81
	1.0	1660	1140	741	0.84
T4	0.1	1970	850	524	0.60
	0.2	1930	880	541	0.62
	0.3	1885	910	558	0.64
	0.4	1845	935	574	0.66
	0.5	1800	970	589	0.68
	0.6	1755	1000	606	0.70
	0.7	1710	1030	623	0.73
	0.8	1660	1055	640	0.74
	0.9	1605	1085	655	0.76
	1.0	1550	1120	672	0.79
T5	0.1	2245	950	752	0.85
	0.2	2215	975	769	0.87
	0.3	2175	1000	787	0.89
	0.4	2135	1025	805	0.92
	0.5	2100	1050	823	0.94
	0.6	2060	1075	839	0.96
	0.7	2025	1100	857	0.98
	0.8	1985	1130	874	1.01
	0.9	1940	1155	891	1.03
	1.0	1895	1175	909	1.05

APPENDIX A BLOWER PERFORMANCE TABLES - AC

DFC0603W / DFC0604W / DFC0607W DOWNSHOT					
TAP	STATIC	AIRFLOW (CFM)	RPM	WATTS	BHP
T1	0.8	1780	1040	683	0.70
	0.9	1740	1070	700	0.72
	1.0	1700	1090	715	0.74
	1.1	1665	1115	730	0.75
	1.2	1625	1145	744	0.77
	1.3	1585	1170	762	0.79
	1.4	1545	1195	777	0.81
	1.5	1510	1215	791	0.82
	1.6	1475	1240	806	0.84
	1.7	1430	1260	818	0.85
	1.8	1395	1280	832	0.86
1.9	1350	1305	847	0.88	
2.0	1300	1325	856	0.89	
T2	0.8	2020	1100	871	0.92
	0.9	1945	1110	850	0.92
	1.0	1910	1135	866	0.94
	1.1	1875	1160	883	0.97
	1.2	1835	1185	898	0.99
	1.3	1800	1210	918	1.01
	1.4	1765	1235	935	1.03
	1.5	1725	1255	950	1.04
	1.6	1690	1275	966	1.06
	1.7	1650	1295	981	1.08
	1.8	1615	1320	995	1.10
1.9	1580	1340	1011	1.12	
2.0	1540	1360	1024	1.13	
T3	0.8	2090	1115	933	0.98
	0.9	2060	1140	951	1.00
	1.0	2030	1165	968	1.02
	1.1	1995	1190	987	1.05
	1.2	1960	1215	1003	1.07
	1.3	1925	1235	1024	1.09
	1.4	1895	1255	1042	1.10
	1.5	1855	1280	1057	1.13
	1.6	1825	1300	1075	1.14
	1.7	1785	1320	1090	1.16
	1.8	1745	1340	1106	1.18
1.9	1715	1360	1122	1.20	
2.0	1675	1380	1137	1.21	
T4	0.8	2090	1115	933	0.98
	0.9	2060	1140	951	1.00
	1.0	2030	1165	968	1.02
	1.1	1995	1190	987	1.05
	1.2	1960	1215	1003	1.07
	1.3	1925	1235	1024	1.09
	1.4	1895	1255	1042	1.10
	1.5	1855	1280	1057	1.13
	1.6	1825	1300	1075	1.14
	1.7	1785	1320	1090	1.16
	1.8	1745	1340	1106	1.18
1.9	1715	1360	1122	1.20	
2.0	1675	1380	1137	1.21	
T5	0.8	2200	1145	1041	1.10
	0.9	2170	1170	1059	1.12
	1.0	2140	1190	1078	1.14
	1.1	2110	1215	1097	1.16
	1.2	2075	1240	1114	1.19
	1.3	2045	1260	1136	1.21
	1.4	2010	1280	1154	1.23
	1.5	1980	1300	1172	1.25
	1.6	1945	1325	1190	1.27
	1.7	1905	1345	1206	1.29
	1.8	1875	1365	1222	1.31
1.9	1845	1380	1240	1.32	
2.0	1810	1400	1256	1.34	

DFC0603W / DFC0604W / DFC0607W DOWNSHOT					
TAP	STATIC	AIRFLOW (CFM)	RPM	WATTS	BHP
T1'	0.8	1950	1085	812	0.85
	0.9	1920	1105	830	0.87
	1.0	1885	1130	846	0.89
	1.1	1850	1155	863	0.91
	1.2	1810	1180	878	0.93
	1.3	1775	1205	898	0.95
	1.4	1735	1230	915	0.97
	1.5	1700	1250	929	0.98
	1.6	1665	1270	946	1.00
	1.7	1625	1290	959	1.01
	1.8	1590	1315	974	1.03
1.9	1550	1335	989	1.05	
2.0	1510	1355	1002	1.06	
T2'	0.8	2135	1130	975	1.03
	0.9	2105	1155	994	1.05
	1.0	2075	1175	1012	1.07
	1.1	2040	1200	1030	1.09
	1.2	2005	1225	1047	1.12
	1.3	1975	1245	1068	1.13
	1.4	1940	1265	1085	1.15
	1.5	1905	1290	1103	1.18
	1.6	1875	1310	1120	1.19
	1.7	1835	1330	1136	1.21
	1.8	1800	1350	1151	1.23
1.9	1770	1370	1168	1.25	
2.0	1730	1390	1183	1.27	
T3'	0.8	2270	1165	1109	1.17
	0.9	2235	1185	1128	1.19
	1.0	2205	1210	1147	1.22
	1.1	2175	1230	1166	1.24
	1.2	2140	1250	1183	1.26
	1.3	2110	1275	1207	1.28
	1.4	2080	1295	1225	1.30
	1.5	2045	1315	1244	1.32
	1.6	2015	1340	1262	1.35
	1.7	1980	1355	1279	1.36
	1.8	1945	1375	1295	1.38
1.9	1915	1395	1314	1.40	
2.0	1885	1415	1330	1.42	
T4'	0.8	2335	1180	1179	1.24
	0.9	2305	1205	1199	1.27
	1.0	2275	1225	1217	1.29
	1.1	2240	1250	1238	1.32
	1.2	2205	1265	1256	1.33
	1.3	2175	1285	1279	1.35
	1.4	2145	1310	1298	1.38
	1.5	2115	1330	1317	1.40
	1.6	2085	1350	1337	1.42
	1.7	2045	1370	1353	1.44
	1.8	2015	1390	1371	1.46
1.9	1985	1410	1390	1.48	
2.0	1955	1420	1407	1.49	
T5'	0.8	2530	1235	1429	1.49
	0.9	2500	1250	1451	1.51
	1.0	2470	1270	1472	1.54
	1.1	2445	1295	1493	1.57
	1.2	2410	1315	1514	1.59
	1.3	2385	1335	1538	1.61
	1.4	2355	1355	1558	1.64
	1.5	2325	1375	1581	1.66
	1.6	2295	1395	1601	1.69
	1.7	2265	1415	1620	1.71
	1.8	2230	1430	1641	1.73
1.9	2200	1445	1661	1.75	
2.0	2170	1465	1678	1.77	

APPENDIX A BLOWER PERFORMANCE TABLES - AC

DFC0603W / DFC0604W / DFC0607W HORIZONTAL					
TAP	STATIC	AIRFLOW (CFM)	RPM	WATTS	BHP
T1	0.8	1760	1070	703	0.72
	0.9	1725	1100	721	0.74
	1.0	1685	1125	736	0.76
	1.1	1650	1150	752	0.78
	1.2	1610	1180	766	0.80
	1.3	1570	1205	785	0.81
	1.4	1530	1230	800	0.83
	1.5	1495	1250	815	0.84
	1.6	1460	1275	830	0.86
	1.7	1415	1300	843	0.88
	1.8	1380	1320	857	0.89
	1.9	1335	1345	872	0.91
2.0	1285	1365	882	0.92	
T2	0.8	2000	1135	897	0.94
	0.9	1925	1145	875	0.95
	1.0	1890	1170	892	0.97
	1.1	1855	1195	910	0.99
	1.2	1815	1220	925	1.02
	1.3	1780	1245	946	1.04
	1.4	1745	1270	963	1.06
	1.5	1710	1295	978	1.08
	1.6	1675	1315	995	1.09
	1.7	1635	1335	1010	1.11
	1.8	1600	1360	1025	1.13
	1.9	1565	1380	1041	1.15
2.0	1525	1400	1055	1.17	
T3	0.8	2070	1150	961	1.01
	0.9	2040	1175	980	1.03
	1.0	2010	1200	997	1.06
	1.1	1975	1225	1017	1.08
	1.2	1940	1250	1033	1.10
	1.3	1905	1270	1055	1.12
	1.4	1875	1295	1073	1.14
	1.5	1835	1320	1089	1.16
	1.6	1805	1340	1107	1.18
	1.7	1765	1360	1123	1.20
	1.8	1730	1380	1139	1.21
	1.9	1700	1400	1156	1.23
2.0	1660	1420	1171	1.25	
T4	0.8	2070	1150	961	1.01
	0.9	2040	1175	980	1.03
	1.0	2010	1200	997	1.06
	1.1	1975	1225	1017	1.08
	1.2	1940	1250	1033	1.10
	1.3	1905	1270	1055	1.12
	1.4	1875	1295	1073	1.14
	1.5	1835	1320	1089	1.16
	1.6	1805	1340	1107	1.18
	1.7	1765	1360	1123	1.20
	1.8	1730	1380	1139	1.21
	1.9	1700	1400	1156	1.23
2.0	1660	1420	1171	1.25	
T5	0.8	2180	1180	1072	1.13
	0.9	2150	1205	1091	1.15
	1.0	2120	1225	1110	1.17
	1.1	2090	1250	1130	1.20
	1.2	2055	1275	1147	1.22
	1.3	2025	1300	1170	1.25
	1.4	1990	1320	1189	1.26
	1.5	1960	1340	1207	1.28
	1.6	1925	1365	1226	1.31
	1.7	1885	1385	1242	1.33
	1.8	1855	1405	1259	1.35
	1.9	1825	1420	1277	1.36
2.0	1790	1440	1294	1.38	

DFC0603W / DFC0604W / DFC0607W HORIZONTAL					
TAP	STATIC	AIRFLOW (CFM)	RPM	WATTS	BHP
T1'	0.8	1930	1115	836	0.88
	0.9	1900	1140	855	0.90
	1.0	1865	1165	871	0.92
	1.1	1830	1190	889	0.93
	1.2	1790	1215	904	0.95
	1.3	1755	1240	925	0.97
	1.4	1720	1265	942	0.99
	1.5	1685	1290	957	1.01
	1.6	1650	1310	974	1.03
	1.7	1610	1330	988	1.04
	1.8	1575	1355	1003	1.06
	1.9	1535	1375	1019	1.08
2.0	1495	1395	1032	1.10	
T2'	0.8	2115	1165	1004	1.06
	0.9	2085	1190	1024	1.08
	1.0	2055	1210	1042	1.10
	1.1	2020	1235	1061	1.13
	1.2	1985	1260	1078	1.15
	1.3	1955	1280	1100	1.17
	1.4	1920	1305	1118	1.19
	1.5	1885	1330	1136	1.21
	1.6	1855	1350	1154	1.23
	1.7	1815	1370	1170	1.25
	1.8	1780	1390	1186	1.27
	1.9	1750	1410	1203	1.28
2.0	1715	1430	1219	1.30	
T3'	0.8	2245	1200	1142	1.21
	0.9	2215	1220	1162	1.23
	1.0	2185	1245	1181	1.25
	1.1	2155	1265	1201	1.27
	1.2	2120	1290	1219	1.30
	1.3	2090	1315	1243	1.32
	1.4	2060	1335	1262	1.34
	1.5	2025	1355	1281	1.36
	1.6	1995	1380	1300	1.39
	1.7	1960	1395	1317	1.40
	1.8	1925	1415	1334	1.42
	1.9	1895	1435	1353	1.44
2.0	1865	1455	1370	1.46	
T4'	0.8	2310	1215	1214	1.28
	0.9	2280	1240	1235	1.31
	1.0	2250	1260	1254	1.33
	1.1	2220	1285	1275	1.35
	1.2	2185	1305	1294	1.37
	1.3	2155	1325	1317	1.39
	1.4	2125	1350	1337	1.42
	1.5	2095	1370	1357	1.44
	1.6	2065	1390	1377	1.46
	1.7	2025	1410	1394	1.48
	1.8	1995	1430	1412	1.51
	1.9	1965	1450	1432	1.53
2.0	1935	1465	1449	1.54	
T5'	0.8	2505	1270	1472	1.54
	0.9	2475	1290	1495	1.56
	1.0	2445	1310	1516	1.58
	1.1	2420	1335	1538	1.61
	1.2	2385	1355	1559	1.64
	1.3	2360	1375	1584	1.66
	1.4	2330	1395	1605	1.69
	1.5	2300	1415	1628	1.71
	1.6	2270	1435	1649	1.74
	1.7	2240	1455	1669	1.76
	1.8	2210	1475	1690	1.78
	1.9	2180	1490	1711	1.80
2.0	2150	1500	1728	1.81	

APPENDIX A BLOWER PERFORMANCE TABLES - AC

DFC0723D / DFC0724D / DFC0727D DOWNSHOT					
TAP	STATIC	AIRFLOW (CFM)	RPM	WATTS	BHP
T1	0.1	1955	800	459	0.50
	0.2	1920	825	473	0.51
	0.3	1880	855	487	0.53
	0.4	1845	880	500	0.54
	0.5	1810	910	516	0.56
	0.6	1765	940	531	0.58
	0.7	1725	975	547	0.60
	0.8	1680	1005	562	0.62
T2	0.1	1375	615	200	0.20
	0.2	1325	655	211	0.22
	0.3	1275	695	223	0.23
	0.4	1215	740	236	0.25
	0.5	1155	785	249	0.26
	0.6	1100	830	263	0.28
	0.7	1045	875	274	0.29
	0.8	985	920	288	0.31
T3	0.1	2455	970	850	0.92
	0.2	2425	990	865	0.94
	0.3	2390	1015	882	0.97
	0.4	2355	1035	899	0.99
	0.5	2320	1060	914	1.01
	0.6	2290	1080	932	1.03
	0.7	2255	1100	947	1.05
	0.8	2220	1120	963	1.07
T4	0.1	2180	875	604	0.66
	0.2	2145	900	619	0.68
	0.3	2110	920	634	0.69
	0.4	2080	945	648	0.71
	0.5	2045	970	664	0.73
	0.6	2010	995	680	0.75
	0.7	1975	1020	696	0.77
	0.8	1935	1050	712	0.79
T5	0.1	2455	970	850	0.92
	0.2	2425	990	865	0.94
	0.3	2390	1015	882	0.97
	0.4	2355	1035	899	0.99
	0.5	2320	1060	914	1.01
	0.6	2290	1080	932	1.03
	0.7	2255	1100	947	1.05
	0.8	2220	1120	963	1.07

DFC0723D / DFC0724D / DFC0727D HORIZONTAL					
TAP	STATIC	AIRFLOW (CFM)	RPM	WATTS	BHP
T1	0.1	1995	790	452	0.49
	0.2	1960	815	466	0.50
	0.3	1920	845	480	0.52
	0.4	1880	870	493	0.54
	0.5	1845	900	508	0.56
	0.6	1800	930	523	0.58
	0.7	1760	965	539	0.60
	0.8	1715	995	554	0.62
T2	0.1	1405	610	197	0.20
	0.2	1350	650	208	0.22
	0.3	1300	690	220	0.23
	0.4	1240	735	232	0.24
	0.5	1180	775	245	0.26
	0.6	1120	820	259	0.27
	0.7	1065	865	270	0.29
	0.8	1005	910	284	0.30
T3	0.1	2505	960	837	0.91
	0.2	2475	980	852	0.93
	0.3	2440	1005	869	0.96
	0.4	2400	1025	886	0.98
	0.5	2365	1050	900	1.00
	0.6	2335	1070	918	1.02
	0.7	2300	1090	933	1.04
	0.8	2265	1110	949	1.06
T4	0.1	2225	865	595	0.65
	0.2	2190	890	610	0.67
	0.3	2150	910	624	0.68
	0.4	2120	935	638	0.70
	0.5	2085	960	654	0.72
	0.6	2050	985	670	0.74
	0.7	2015	1010	686	0.76
	0.8	1975	1040	701	0.78
T5	0.1	2505	960	837	0.91
	0.2	2475	980	852	0.93
	0.3	2440	1005	869	0.96
	0.4	2400	1025	886	0.98
	0.5	2365	1050	900	1.00
	0.6	2335	1070	918	1.02
	0.7	2300	1090	933	1.04
	0.8	2265	1110	949	1.06

APPENDIX A BLOWER PERFORMANCE TABLES - AC

DFC0723W / DFC0724W / DFC0727W DOWNSHOT					
TAP	STATIC	AIRFLOW (CFM)	RPM	WATTS	BHP
T1	0.6	2115	1045	836	0.87
	0.7	2080	1070	854	0.89
	0.8	2045	1095	872	0.91
	0.9	1985	1120	891	0.93
	1.0	1970	1155	896	0.96
	1.1	1940	1170	924	0.97
	1.2	1910	1195	944	0.99
	1.3	1875	1215	962	1.01
	1.4	1850	1240	982	1.03
	1.5	1815	1265	1001	1.05
1.6	1775	1290	1017	1.07	
1.7	1740	1310	1037	1.09	
1.8	1705	1335	1055	1.11	
T2	0.6	1920	990	686	0.70
	0.7	1885	1020	703	0.72
	0.8	1845	1045	720	0.74
	0.9	1790	1075	736	0.76
	1.0	1770	1110	746	0.78
	1.1	1735	1125	769	0.80
	1.2	1700	1155	786	0.82
	1.3	1665	1180	803	0.83
	1.4	1650	1205	832	0.85
	1.5	1610	1230	850	0.87
1.6	1575	1260	866	0.89	
1.7	1535	1285	885	0.91	
1.8	1495	1310	902	0.93	
T3	0.6	2595	1175	1332	1.38
	0.7	2560	1195	1354	1.41
	0.8	2525	1220	1376	1.44
	0.9	2465	1240	1399	1.46
	1.0	2460	1275	1406	1.50
	1.1	2435	1280	1441	1.51
	1.2	2405	1300	1463	1.53
	1.3	2375	1320	1484	1.56
	1.4	2335	1340	1498	1.58
	1.5	2305	1360	1519	1.60
1.6	2275	1380	1538	1.63	
1.7	2245	1400	1559	1.65	
1.8	2210	1420	1580	1.67	
T4	0.6	2700	1205	1475	1.52
	0.7	2665	1225	1499	1.55
	0.8	2635	1245	1522	1.57
	0.9	2570	1265	1546	1.60
	1.0	2570	1300	1556	1.64
	1.1	2540	1305	1590	1.65
	1.2	2510	1325	1612	1.68
	1.3	2480	1345	1634	1.70
	1.4	2445	1365	1650	1.73
	1.5	2415	1385	1672	1.75
1.6	2380	1400	1692	1.77	
1.7	2355	1420	1713	1.80	
1.8	2320	1440	1735	1.82	
T5	0.6	2690	1200	1462	1.51
	0.7	2655	1220	1485	1.53
	0.8	2625	1245	1508	1.56
	0.9	2565	1265	1532	1.59
	1.0	2560	1295	1542	1.63
	1.1	2530	1305	1576	1.64
	1.2	2500	1325	1598	1.67
	1.3	2470	1340	1620	1.68
	1.4	2435	1360	1636	1.71
	1.5	2405	1380	1658	1.73
1.6	2375	1400	1678	1.76	
1.7	2345	1420	1699	1.78	
1.8	2310	1440	1720	1.81	

DFC0723W / DFC0724W / DFC0727W DOWNSHOT					
TAP	STATIC	AIRFLOW (CFM)	RPM	WATTS	BHP
T1'	0.6	2280	1085	980	1.02
	0.7	2240	1110	1000	1.05
	0.8	2205	1135	1019	1.07
	0.9	2150	1160	1039	1.09
	1.0	2140	1195	1043	1.13
	1.1	2105	1205	1074	1.14
	1.2	2075	1225	1096	1.15
	1.3	2045	1250	1114	1.18
	1.4	2010	1270	1130	1.20
	1.5	1980	1295	1149	1.22
1.6	1945	1315	1166	1.24	
1.7	1910	1340	1186	1.26	
1.8	1875	1360	1205	1.28	
T2'	0.6	2070	1030	797	0.83
	0.7	2030	1055	815	0.85
	0.8	1995	1085	833	0.87
	0.9	1940	1110	851	0.89
	1.0	1925	1145	857	0.92
	1.1	1890	1160	884	0.93
	1.2	1855	1185	903	0.95
	1.3	1825	1205	921	0.97
	1.4	1800	1230	943	0.99
	1.5	1765	1255	961	1.01
1.6	1725	1280	977	1.03	
1.7	1690	1305	997	1.05	
1.8	1650	1330	1015	1.07	
T3'	0.6	2750	1215	1543	1.58
	0.7	2715	1240	1567	1.62
	0.8	2680	1260	1590	1.64
	0.9	2620	1280	1615	1.67
	1.0	2620	1310	1627	1.71
	1.1	2590	1320	1661	1.72
	1.2	2560	1335	1683	1.74
	1.3	2530	1355	1705	1.77
	1.4	2490	1375	1722	1.79
	1.5	2465	1395	1745	1.82
1.6	2430	1415	1765	1.84	
1.7	2405	1430	1786	1.86	
1.8	2370	1450	1809	1.89	
T4'	0.6	2820	1240	1654	1.69
	0.7	2785	1260	1679	1.72
	0.8	2755	1280	1703	1.75
	0.9	2690	1300	1729	1.78
	1.0	2690	1325	1744	1.81
	1.1	2660	1335	1777	1.82
	1.2	2630	1355	1799	1.85
	1.3	2600	1375	1822	1.88
	1.4	2565	1395	1842	1.91
	1.5	2535	1415	1865	1.93
1.6	2505	1430	1887	1.95	
1.7	2480	1450	1908	1.98	
1.8	2445	1465	1931	2.00	
T5'	0.6	2855	1250	1712	1.75
	0.7	2820	1265	1737	1.77
	0.8	2790	1290	1762	1.80
	0.9	2725	1310	1787	1.83
	1.0	2725	1335	1804	1.87
	1.1	2695	1345	1837	1.88
	1.2	2665	1365	1858	1.91
	1.3	2635	1385	1882	1.94
	1.4	2600	1405	1904	1.96
	1.5	2575	1420	1927	1.99
1.6	2540	1440	1949	2.01	
1.7	2515	1460	1970	2.04	
1.8	2480	1475	1993	2.06	

APPENDIX A BLOWER PERFORMANCE TABLES - AC

DFC0723W / DFC0724W / DFC0727W HORIZONTAL					
TAP	STATIC	AIRFLOW (CFM)	RPM	WATTS	BHP
T1	0.6	2085	1080	869	0.90
	0.7	2050	1105	888	0.92
	0.8	2015	1135	907	0.94
	0.9	1955	1160	927	0.97
	1.0	1940	1195	932	0.99
	1.1	1910	1210	961	1.01
	1.2	1880	1235	982	1.03
	1.3	1845	1260	1000	1.05
	1.4	1820	1285	1021	1.07
	1.5	1790	1310	1041	1.09
1.6	1750	1335	1058	1.11	
1.7	1715	1355	1078	1.13	
1.8	1680	1380	1097	1.15	
T2	0.6	1890	1025	713	0.72
	0.7	1855	1055	731	0.75
	0.8	1815	1080	749	0.76
	0.9	1765	1115	765	0.79
	1.0	1745	1150	776	0.81
	1.1	1710	1165	800	0.82
	1.2	1675	1195	817	0.84
	1.3	1640	1220	835	0.86
	1.4	1625	1245	865	0.88
	1.5	1585	1275	884	0.90
1.6	1550	1305	901	0.92	
1.7	1510	1330	920	0.94	
1.8	1475	1355	938	0.96	
T3	0.6	2555	1215	1385	1.43
	0.7	2520	1235	1408	1.45
	0.8	2485	1265	1431	1.49
	0.9	2430	1285	1455	1.51
	1.0	2425	1320	1462	1.56
	1.1	2400	1325	1499	1.56
	1.2	2370	1345	1522	1.58
	1.3	2340	1365	1543	1.61
	1.4	2300	1385	1558	1.63
	1.5	2270	1410	1580	1.66
1.6	2240	1430	1600	1.68	
1.7	2210	1450	1621	1.71	
1.8	2175	1470	1643	1.73	
T4	0.6	2660	1245	1534	1.57
	0.7	2625	1270	1559	1.61
	0.8	2595	1290	1583	1.63
	0.9	2530	1310	1608	1.66
	1.0	2530	1345	1618	1.70
	1.1	2500	1350	1654	1.71
	1.2	2470	1370	1676	1.73
	1.3	2445	1390	1699	1.76
	1.4	2410	1415	1716	1.79
	1.5	2380	1435	1739	1.81
1.6	2345	1450	1760	1.83	
1.7	2320	1470	1782	1.86	
1.8	2285	1490	1804	1.88	
T5	0.6	2650	1240	1520	1.56
	0.7	2615	1265	1544	1.59
	0.8	2585	1290	1568	1.62
	0.9	2525	1310	1593	1.65
	1.0	2520	1340	1604	1.68
	1.1	2490	1350	1639	1.70
	1.2	2465	1370	1662	1.72
	1.3	2435	1385	1685	1.74
	1.4	2400	1410	1701	1.77
	1.5	2370	1430	1724	1.80
1.6	2340	1450	1745	1.82	
1.7	2310	1470	1767	1.85	
1.8	2275	1490	1789	1.87	

DFC0723W / DFC0724W / DFC0727W HORIZONTAL					
TAP	STATIC	AIRFLOW (CFM)	RPM	WATTS	BHP
T1'	0.6	2245	1125	1019	1.06
	0.7	2205	1150	1040	1.08
	0.8	2170	1175	1060	1.11
	0.9	2120	1200	1081	1.13
	1.0	2110	1235	1085	1.16
	1.1	2075	1245	1117	1.17
	1.2	2045	1270	1140	1.20
	1.3	2015	1295	1159	1.22
	1.4	1980	1315	1175	1.24
	1.5	1950	1340	1195	1.26
1.6	1915	1360	1213	1.28	
1.7	1880	1385	1233	1.31	
1.8	1845	1410	1253	1.33	
T2'	0.6	2040	1065	829	0.85
	0.7	2000	1090	848	0.87
	0.8	1965	1125	866	0.90
	0.9	1910	1150	885	0.92
	1.0	1895	1185	891	0.95
	1.1	1860	1200	919	0.96
	1.2	1825	1225	939	0.98
	1.3	1800	1245	958	1.00
	1.4	1775	1275	981	1.02
	1.5	1740	1300	999	1.04
1.6	1700	1325	1016	1.06	
1.7	1665	1350	1037	1.08	
1.8	1625	1375	1056	1.10	
T3'	0.6	2710	1260	1605	1.64
	0.7	2675	1285	1630	1.68
	0.8	2640	1305	1654	1.70
	0.9	2580	1325	1680	1.73
	1.0	2580	1355	1692	1.77
	1.1	2550	1365	1727	1.78
	1.2	2520	1380	1750	1.80
	1.3	2490	1400	1773	1.83
	1.4	2455	1425	1791	1.86
	1.5	2430	1445	1815	1.88
1.6	2395	1465	1836	1.91	
1.7	2370	1480	1857	1.93	
1.8	2335	1500	1881	1.96	
T4'	0.6	2780	1285	1720	1.76
	0.7	2745	1305	1746	1.78
	0.8	2715	1325	1771	1.81
	0.9	2650	1345	1798	1.84
	1.0	2650	1370	1814	1.87
	1.1	2620	1380	1848	1.89
	1.2	2590	1400	1871	1.91
	1.3	2560	1425	1895	1.95
	1.4	2525	1445	1916	1.97
	1.5	2495	1465	1940	2.00
1.6	2465	1480	1962	2.02	
1.7	2445	1500	1984	2.05	
1.8	2410	1515	2008	2.07	
T5'	0.6	2810	1295	1780	1.81
	0.7	2780	1310	1806	1.83
	0.8	2750	1335	1832	1.87
	0.9	2685	1355	1858	1.89
	1.0	2685	1380	1876	1.93
	1.1	2655	1390	1910	1.94
	1.2	2625	1415	1932	1.98
	1.3	2595	1435	1957	2.01
	1.4	2560	1455	1980	2.03
	1.5	2535	1470	2004	2.06
1.6	2500	1490	2027	2.08	
1.7	2475	1510	2049	2.11	
1.8	2445	1525	2073	2.13	

APPENDIX B ELECTRICAL DATA

Model Number	Electrical Rating	Compressor			Outdoor Fan Motor			Indoor Fan Motor			Optional Electric Heat			Optional Powered Convenience Outlet	Optional Power Exhaust	Power Supply	
		QTY	RLA	LRA	QTY	HP	FLA	Type	HP	FLA	Part #	KW*	FLA	FLA	FLA	MCA	MOP
DFC0361D	208/230/1/60	1	16.7	79	1	0.17	0.95	Direct Drive Standard Static	0.75	5.7	-	-	-	-	27.5/27.5	40/40	
											-	-	-	9.6/8.7	-	37.1/36.2	50/50
											-	-	-	-	1.7/1.5	29.2/29.0	40/40
											-	-	-	9.6/8.7	1.7/1.5	38.8/37.7	50/50
											-	-	-	-	-	29.7/33.2	40/40
											-	-	-	9.6/8.7	-	41.7/44.0	50/50
											-	-	-	1.7/1.5	-	31.8/35.0	40/40
											-	-	-	9.6/8.7	1.7/1.5	43.8/45.9	50/50
											-	-	-	-	-	52.3/59.2	60/60
											-	-	-	9.6/8.7	-	64.3/70.1	70/80
											-	-	-	1.7/1.5	-	54.4/61.1	60/70
											-	-	-	9.6/8.7	1.7/1.5	66.4/72.0	70/80
DFC0363D	208/230/3/60	1	10.4	73	1	0.17	0.95	Direct Drive Standard Static	0.75	5.7	-	-	-	-	19.7/19.7	30/30	
											-	-	-	9.6/8.7	-	29.3/28.4	35/35
											-	-	-	-	1.7/1.5	21.4/21.2	30/30
											-	-	-	9.6/8.7	1.7/1.5	31.0/29.9	35/35
											-	-	-	-	-	20.2/22.2	30/30
											-	-	-	9.6/8.7	-	32.2/33.0	35/35
											-	-	-	1.7/1.5	-	22.3/24.0	30/30
											-	-	-	9.6/8.7	1.7/1.5	34.3/34.9	35/35
											-	-	-	-	-	33.2/37.2	35/40
											-	-	-	9.6/8.7	-	45.2/48.1	50/50
											-	-	-	1.7/1.5	-	35.3/39.1	40/40
											-	-	-	9.6/8.7	1.7/1.5	47.3/49.9	50/50
DFC0363W	208/230/3/60	1	10.4	73	1	0.17	0.95	Direct Drive High Static	1.2	5	-	-	-	-	10.2	15	
											-	-	-	4.3	-	14.5	20
											-	-	-	-	0.5	10.7	15
											-	-	-	4.3	0.5	15	20
											-	-	-	-	-	10.6	15
											-	-	-	4.3	-	16	20
											-	-	-	5	6.01	11.3	15
											-	-	-	4.3	0.5	16.6	20
											-	-	-	-	-	18.2	20
											-	-	-	4.3	-	23.5	25
											-	-	-	10	12	18.8	20
											-	-	-	4.3	0.5	24.2	25
DFC0364D	460/3/60	1	5.8	38	1	0.17	0.48	Direct Drive Standard Static	1.2	2.5	-	-	-	-	10.2	15	
											-	-	-	4.3	-	14.5	20
											-	-	-	-	0.5	10.7	15
											-	-	-	4.3	0.5	15	20
											-	-	-	-	-	10.6	15
											-	-	-	4.3	-	16	20
											-	-	-	5	6.01	11.3	15
											-	-	-	4.3	0.5	16.6	20
											-	-	-	-	-	18.2	20
											-	-	-	4.3	-	23.5	25
											-	-	-	10	12	18.8	20
											-	-	-	4.3	0.5	24.2	25
DFC0364W	460/3/60	1	5.8	38	1	0.17	0.48	Direct Drive High Static	1.2	2.5	-	-	-	-	10.2	15	
											-	-	-	4.3	-	14.5	20
											-	-	-	-	0.5	10.7	15
											-	-	-	4.3	0.5	15	20
											-	-	-	-	-	10.6	15
											-	-	-	4.3	-	16	20
											-	-	-	5	6.01	11.3	15
											-	-	-	4.3	0.5	16.6	20
											-	-	-	-	-	18.2	20
											-	-	-	4.3	-	23.5	25
											-	-	-	10	12	18.8	20
											-	-	-	4.3	0.5	24.2	25
DFC0367D	575/3/60	1	3.8	36.5	1	0.17	0.39	Direct Drive Standard Static	1.2	2	-	-	-	-	7.12	15	
											-	-	-	3.5	-	10.6	15
											-	-	-	-	0.6	7.72	15
											-	-	-	3.5	0.6	11.2	15
											-	-	-	-	-	8.51	15
											-	-	-	3.5	-	12.9	15
											-	-	-	5	4.81	9.26	15
											-	-	-	3.5	0.6	13.6	15
											-	-	-	-	-	14.5	15
											-	-	-	3.5	-	18.9	20
											-	-	-	10	9.62	15.3	20
											-	-	-	3.5	0.6	19.7	20

APPENDIX B ELECTRICAL DATA

Model Number	Electrical Rating	Compressor			Outdoor Fan Motor			Indoor Fan Motor			Optional Electric Heat			Optional Powered Convenience Outlet		Optional Power Exhaust		Power Supply	
		QTY	RLA	LRA	QTY	HP	FLA	Type	HP	FLA	Part #	KW*	FLA	FLA	FLA	MCA	MOP		
DFC0367W	575/3/60	1	3.8	36.5	1	0.17	0.39	Direct Drive High Static	1.2	2	-	-	-	-	-	7.12	15		
											-	-	-	3.5	-	10.6	15		
											-	-	-	-	0.6	7.72	15		
											-	-	-	3.5	0.6	11.2	15		
											-	-	-	-	-	8.51	15		
											EH*D-7S06	5	4.81	3.5	-	12.9	15		
														-	0.6	9.26	15		
														3.5	0.6	13.6	15		
											-	-	-	-	-	14.5	15		
											-	-	-	3.5	-	18.9	20		
											EH*D-7S11	10	9.62	-	0.6	15.3	20		
														3.5	0.6	19.7	20		
-	-	20.5	25																
EH*D-7S17	15	14.4	3.5	-	24.9	25													
			-	0.6	21.3	25													
			3.5	0.6	25.7	30													
DFC0481D	208/230/1/60	1	19.9	109	1	0.33	2	Direct Drive Standard Static	1	6.9	-	-	-	-	-	33.7/33.7	50/50		
											-	-	-	9.6/8.7	-	43.3/42.4	60/60		
											-	-	-	-	1.7/1.5	35.4/35.2	50/50		
											-	-	-	9.6/8.7	1.7/1.5	45.0/43.9	60/60		
											-	-	-	-	-	33.7/34.7	50/50		
											EH*D-1S06	3.76/5.00	18.1/20.8	9.6/8.7	-	43.3/45.5	60/60		
														-	1.7/1.5	35.4/36.5	50/50		
														9.6/8.7	1.7/1.5	45.3/47.4	60/60		
											EH*D-1S11	7.51/10.0	36.1/41.7	-	-	53.8/60.7	60/70		
														9.6/8.7	-	65.8/71.6	70/80		
														-	1.7/1.5	55.9/62.6	60/70		
											EH*D-1S17	11.3/15.0	54.2/62.5	9.6/8.7	1.7/1.5	67.9/73.5	70/80		
														-	-	76.3/86.8	80/90		
														9.6/8.7	-	88.3/97.6	90/100		
											EH*D-1S23	15.0/20.0	72.2/83.3	-	1.7/1.5	78.5/88.6	80/90		
														9.6/8.7	1.7/1.5	90.5/99.5	100/100		
														-	-	98.9/113	100/125		
											-	-	-	9.6/8.7	-	111/124	125/125		
-	-	-	-	1.7/1.5	101/115	110/125													
-	-	-	9.6/8.7	1.7/1.5	113/126	125/150													
DFC0483D	208/230/3/60	1	13.1	83.1	1	0.33	2	Direct Drive Standard Static	1	6.9	-	-	-	-	-	25.3/25.3	35/35		
											-	-	-	9.6/8.7	-	34.9/34.0	45/45		
											-	-	-	-	1.7/1.5	27.0/26.8	35/35		
											-	-	-	9.6/8.7	1.7/1.5	36.6/35.5	45/45		
											-	-	-	-	-	25.3/25.3	35/35		
											EH*D-3S06	3.76/5.00	10.4/12.0	9.6/8.7	-	34.9/34.5	45/45		
														-	1.7/1.5	27.0/26.8	35/35		
														9.6/8.7	1.7/1.5	36.6/36.4	45/45		
											-	-	-	-	-	34.7/38.7	35/40		
											EH*D-3S11	7.51/10.0	20.8/24.1	9.6/8.7	-	46.7/49.6	50/50		
														-	1.7/1.5	36.8/40.6	40/45		
														9.6/8.7	1.7/1.5	48.8/51.4	50/60		
											EH*D-3S17	11.3/15.0	31.3/36.1	-	-	47.7/53.7	50/60		
														9.6/8.7	1.7/1.5	59.7/64.6	60/70		
														-	1.7/1.5	49.8/55.6	50/60		
											EH*D-3S23	15.0/19.9	41.5/47.9	9.6/8.7	1.7/1.5	61.8/66.5	70/70		
														-	-	60.5/68.5	70/70		
														9.6/8.7	1.7/1.5	72.5/79.3	80/80		
-	-	-	-	1.7/1.5	62.6/70.3	70/80													
-	-	-	9.6/8.7	1.7/1.5	74.6/81.2	80/90													
DFC0483W	208/230/3/60	1	13.1	83.1	1	0.33	2	Direct Drive High Static	1.2	5	-	-	-	-	-	33.0/32.1	45/45		
											-	-	-	9.6/8.7	1.7/1.5	25.1/24.9	35/35		
											-	-	-	9.6/8.7	1.7/1.5	34.7/33.6	45/45		
											-	-	-	-	-	23.4/23.4	35/35		
											EH*D-3S06	3.76/5.00	10.4/12.0	9.6/8.7	-	33.0/32.2	45/45		
														-	1.7/1.5	25.1/24.9	35/35		
														9.6/8.7	1.7/1.5	34.7/34.0	45/45		
											-	-	-	-	-	32.3/36.3	35/40		
											EH*D-3S11	7.51/10.0	20.8/24.1	9.6/8.7	-	44.3/47.2	45/50		
														-	1.7/1.5	34.4/38.2	35/40		
														9.6/8.7	1.7/1.5	46.4/49.1	50/50		
											-	-	-	-	-	45.3/51.4	50/60		
											EH*D-3S17	11.3/15.0	31.3/36.1	9.6/8.7	-	57.3/62.2	60/70		
														-	1.7/1.5	47.5/53.2	50/60		
														9.6/8.7	1.7/1.5	59.5/64.1	60/70		
											EH*D-3S23	15.0/19.9	41.5/47.9	-	-	58.1/66.1	60/70		
														9.6/8.7	-	70.1/77.0	80/80		
														-	1.7/1.5	60.2/68.0	70/70		
-	-	-	9.6/8.7	1.7/1.5	72.2/78.8	80/80													
DFC0484D	460/3/60	1	6.1	41	1	0.33	0.85	Direct Drive Standard Static	1.2	2.5	-	-	-	-	-	11	15		
											-	-	-	4.3	-	15.3	20		
											-	-	-	-	0.5	11.5	15		
											-	-	-	4.3	0.5	15.8	20		
											-	-	-	-	-	11	15		
											EH*D-4S06	5	6.01	4.3	-	16	20		
														-	0.5	11.5	15		
														4.3	0.5	16.6	20		
											-	-	-	-	-	18.2	20		
											EH*D-4S11	10	12	4.3	-	23.5	25		
														-	0.5	18.8	20		
														4.3	0.5	24.2	25		
											-	-	-	-	-	25.7	30		
											EH*D-4S17	15	18	4.3	-	31.1	35		
														-	0.5	26.3	30		
														4.3	0.5	31.7	35		
											-	-	-	-	-	33.2	35		
											EH*D-4S23	20	24.1	4.3	-	38.6	40		
-	0.5	33.8	35																
4.3	0.5	39.2	40																
-	-	-	-	-	11	15													
DFC0484W	460/3/60	1	6.1	41	1	0.33	0.85	Direct Drive High Static	1.2	2.5	-	-	-	-	-	15.3	20		
											-	-	-	4.3	-	11.5	15		
											-	-	-	-	0.5	15.8	20		
											-	-	-	4.3	0.5	15.8	20		
											-	-	-	-	-	11	15		
											EH*D-4S06	5	6.01	4.3	-	16	20		
														-	0.5	11.5	15		
														4.3	0.5	16.6	20		
											-	-	-	-	-	18.2	20		
											EH*D-4S11	10	12	4.3	-	23.5	25		
														-	0.5	18.8	20		
														4.3	0.5	24.2	25		
											-	-	-	-	-	25.7	30		
											EH*D-4S17	15	18	4.3	-	31.1	35		
														-	0.5	26.3	30		
														4.3	0.5	31.7	35		
											-	-	-	-	-	33.2	35		
											EH*D-4S23	20	24.1	4.3	-	38.6	40		
-	0.5	33.8	35																
4.3	0.5	39.2	40																

APPENDIX B ELECTRICAL DATA

Model Number	Electrical Rating	Compressor			Outdoor Fan Motor			Indoor Fan Motor			Optional Electric Heat			Optional Powered Convenience Outlet	Optional Power Exhaust	Power Supply	
		QTY	RLA	LRA	QTY	HP	FLA	Type	HP	FLA	Part #	KW*	FLA	FLA	FLA	MCA	MOP
DFC0487D	575/3/60	1	4.4	33	1	0.33	0.67	Direct Drive Standard Static	1.2	2	-	-	-	-	-	8.12	15
											-	-	-	3.5	-	11.6	15
											-	-	-	3.5	0.6	12.2	15
											-	-	-	3.5	-	8.51	15
											EH*D-7S06	5	4.81	-	-	12.9	15
														-	0.6	9.26	15
														-	0.6	13.6	15
											-	-	-	-	-	14.5	15
											EH*D-7S11	10	9.62	-	-	18.9	20
														-	0.6	15.3	20
														-	0.6	19.7	20
											-	-	-	-	-	20.5	25
											EH*D-7S17	15	14.4	-	-	24.9	25
														-	0.6	21.3	25
														-	0.6	25.7	30
-	-	-	-	-	26.6	30											
EH*D-7S23	20	19.2	-	-	30.9	35											
			-	0.6	27.3	30											
			-	0.6	31.7	35											
-	-	-	-	-	8.12	15											
DFC0487W	575/3/60	1	4.4	33	1	0.33	0.67	Direct Drive High Static	1.2	2	-	-	-	-	-	8.12	15
											-	-	-	3.5	-	11.6	15
											-	-	-	3.5	0.6	12.2	15
											-	-	-	3.5	-	8.51	15
											EH*D-7S06	5	4.81	-	-	12.9	15
														-	0.6	9.26	15
														-	0.6	13.6	15
											-	-	-	-	-	14.5	15
											EH*D-7S11	10	9.62	-	-	18.9	20
														-	0.6	15.3	20
														-	0.6	19.7	20
											-	-	-	-	-	20.5	25
											EH*D-7S17	15	14.4	-	-	24.9	25
														-	0.6	21.3	25
														-	0.6	25.7	30
-	-	-	-	-	26.6	30											
EH*D-7S23	20	19.2	-	-	30.9	35											
			-	0.6	27.3	30											
			-	0.6	31.7	35											
-	-	-	-	-	8.12	15											
DFC0601D	208/230/1/60	1	26.4	134	1	0.33	2	Direct Drive Standard Static	1	6.9	-	-	-	-	-	41.9/41.9	60/60
											-	-	-	9.6/8.7	-	51.5/50.6	70/70
											-	-	-	-	1.7/1.5	43.6/43.4	60/60
											-	-	-	9.6/8.7	1.7/1.5	53.2/52.1	70/70
											-	-	-	-	-	41.9/41.9	60/60
											EH*D-1S06	3.76/5.00	18.1/20.8	-	-	51.5/50.6	70/70
														-	1.7/1.5	43.6/43.4	60/60
														-	1.7/1.5	53.2/52.1	70/70
											-	-	-	-	-	53.8/60.7	60/70
											EH*D-1S11	7.51/10.0	36.1/41.7	-	-	65.8/71.6	70/80
														-	1.7/1.5	55.9/62.6	60/70
														-	1.7/1.5	67.9/73.5	70/80
											-	-	-	-	-	76.3/86.8	80/90
											EH*D-1S17	11.3/15.0	54.2/62.5	-	-	88.3/97.6	90/100
														-	1.7/1.5	78.5/88.6	80/90
-	1.7/1.5	90.5/99.5	100/100														
-	-	-	-	-	98.9/113	100/125											
EH*D-1S23	15.0/20.0	72.2/83.3	-	-	111/124	125/125											
			-	1.7/1.5	101/115	110/125											
			-	1.7/1.5	113/126	125/150											
-	-	-	-	-	28.9/28.9	40/40											
-	-	-	-	-	38.5/37.6	50/50											
-	-	-	-	-	30.6/30.4	40/40											
-	-	-	-	-	40.2/39.1	50/50											
-	-	-	-	-	28.9/28.9	40/40											
EH*D-3S06	3.76/5.00	10.4/12.0	-	-	38.5/37.6	50/50											
			-	1.7/1.5	30.6/30.4	40/40											
			-	1.7/1.5	40.2/39.1	50/50											
-	-	-	-	-	34.7/38.7	40/40											
EH*D-3S11	7.51/10.0	20.8/24.1	-	-	46.7/49.6	50/50											
			-	1.7/1.5	36.8/40.6	40/45											
			-	1.7/1.5	48.8/51.4	50/60											
-	-	-	-	-	47.7/53.7	50/60											
EH*D-3S17	11.3/15.0	31.3/36.1	-	-	59.7/64.6	60/70											
			-	1.7/1.5	49.8/55.6	50/60											
			-	1.7/1.5	61.8/66.5	70/70											
-	-	-	-	-	60.5/68.5	70/70											
EH*D-3S23	15.0/19.9	41.5/47.9	-	-	72.5/79.3	80/80											
			-	1.7/1.5	62.6/70.3	70/80											
			-	1.7/1.5	74.6/81.2	80/90											
-	-	-	-	-	29.7/29.7	45/45											
-	-	-	-	-	39.3/38.4	50/50											
-	-	-	-	-	31.4/31.2	45/45											
-	-	-	-	-	41.0/39.9	50/50											
-	-	-	-	-	29.7/29.7	45/45											
EH*D-3S06	3.76/5.00	10.4/12.0	-	-	39.3/38.4	50/50											
			-	1.7/1.5	31.4/31.2	45/45											
			-	1.7/1.5	41.0/39.9	50/50											
-	-	-	-	-	35.7/39.7	45/45											
EH*D-3S11	7.51/10.0	20.8/24.1	-	-	47.7/50.6	50/60											
			-	1.7/1.5	37.8/41.6	45/45											
			-	1.7/1.5	49.8/52.4	50/60											
-	-	-	-	-	48.7/54.7	50/60											
EH*D-3S17	11.3/15.0	31.3/36.1	-	-	60.7/65.6	70/70											
			-	1.7/1.5	50.8/56.6	60/60											
			-	1.7/1.5	62.8/67.5	70/70											
-	-	-	-	-	61.5/69.5	70/70											
EH*D-3S23	15.0/19.9	41.5/47.9	-	-	73.5/80.3	80/90											
			-	1.7/1.5	63.6/71.3	70/80											
			-	1.7/1.5	75.6/82.2	80/90											
-	-	-	-	-	13	20											
-	-	-	-	-	4.3	25											
-	-	-	-	-	0.5	20											
-	-	-	-	-	4.3	25											
-	-	-	-	-	0.5	20											
-	-	-	-	-	13	20											
EH*D-4S06	5	6.01	-	-	17.3	25											
			-	0.5	13.5	20											
			-	0.5	17.8	25											
-	-	-	-	-	13	20											
EH*D-4S11	10	12	-	-	17.3	25											
			-	0.5	13.5	20											
			-	0.5	17.8	25											
-	-	-	-	-	18.2	20											
EH*D-4S17	15	18	-	-	23.5	25											
			-	0.5	18.8	20											
			-	0.5	24.2	25											
-	-	-	-	-	25.7	30											
EH*D-4S23	20	24.1	-	-	31.1	35											
			-	0.5	26.3	30											
			-	0.5	31.7	35											
-	-	-	-	-	33.2	35											
-	-	-	-	-	38.6	40											
-	-	-	-	-	33.8	35											
-	-	-	-	-	39.2	40											

APPENDIX B ELECTRICAL DATA

Model Number	Electrical Rating	Compressor			Outdoor Fan Motor			Indoor Fan Motor			Optional Electric Heat			Optional Powered Convenience Outlet		Optional Power Exhaust		Power Supply	
		QTY	RLA	LRA	QTY	HP	FLA	Type	HP	FLA	Part #	KW*	FLA	FLA	FLA	MCA	MOP		
DFC0604W	460/3/60	1	7.8	52	1	0.33	0.85	Direct Drive High Static	2.3	4.5	-	-	-	4.3	-	15	20	-	-
											-	-	-	-	-	19.3	25	-	-
											-	-	-	-	-	15.5	20	-	-
											-	-	-	-	-	19.8	25	-	-
											-	-	-	-	-	15	20	-	-
											-	-	-	-	-	19.3	25	-	-
											-	-	-	-	-	15.5	20	-	-
											-	-	-	-	-	19.8	25	-	-
											-	-	-	-	-	20.7	25	-	-
											-	-	-	-	-	26	30	-	-
											-	-	-	-	-	21.3	25	-	-
											-	-	-	-	-	26.7	30	-	-
											-	-	-	-	-	28.2	30	-	-
											-	-	-	-	-	33.6	35	-	-
											DFC0607D	575/3/60	1	5.7	38.9	1	0.33	0.67	Direct Drive Standard Static
-	-	-	-	-	10.4	15	-	-											
-	-	-	-	-	13.9	15	-	-											
-	-	-	-	-	9.8	15	-	-											
-	-	-	-	-	13.3	15	-	-											
-	-	-	-	-	10.4	15	-	-											
-	-	-	-	-	9.8	15	-	-											
-	-	-	-	-	13.3	15	-	-											
-	-	-	-	-	10.4	15	-	-											
-	-	-	-	-	9.8	15	-	-											
-	-	-	-	-	13.3	15	-	-											
-	-	-	-	-	10.4	15	-	-											
-	-	-	-	-	9.8	15	-	-											
-	-	-	-	-	13.3	15	-	-											
DFC0607W	575/3/60	1	5.7	38.9	1	0.33	0.67	Direct Drive High Static	2.3	3.8									
											-	-	-	-	-	15.1	20	-	-
											-	-	-	-	-	12.2	15	-	-
											-	-	-	-	-	15.7	20	-	-
											-	-	-	-	-	11.6	15	-	-
											-	-	-	-	-	15.1	20	-	-
											-	-	-	-	-	12.2	15	-	-
											-	-	-	-	-	15.9	20	-	-
											-	-	-	-	-	16.8	20	-	-
											-	-	-	-	-	21.2	25	-	-
											-	-	-	-	-	17.5	20	-	-
											-	-	-	-	-	21.9	25	-	-
											-	-	-	-	-	22.8	25	-	-
											-	-	-	-	-	27.2	30	-	-
											DFC0723D	208/230/3/60	1	17.6	136	1	0.33	2	Direct Drive Standard Static
-	-	-	-	-	38.6/37.7	50/50	-	-											
-	-	-	-	-	30.7/30.5	45/45	-	-											
-	-	-	-	-	40.3/39.2	50/50	-	-											
-	-	-	-	-	29.0/29.0	45/45	-	-											
-	-	-	-	-	38.6/37.7	50/50	-	-											
-	-	-	-	-	30.7/30.5	45/45	-	-											
-	-	-	-	-	40.3/39.2	50/50	-	-											
-	-	-	-	-	32.3/36.3	45/45	-	-											
-	-	-	-	-	44.3/47.2	50/50	-	-											
-	-	-	-	-	41.3/38.2	45/45	-	-											
-	-	-	-	-	46.4/49.1	50/50	-	-											
-	-	-	-	-	45.3/51.4	50/60	-	-											
-	-	-	-	-	57.3/62.2	60/70	-	-											
-	-	-	-	-	47.5/53.2	50/60	-	-											
DFC0723W	208/230/3/60	1	17.6	136	1	0.33	2	Direct Drive High Static	2.3	7.7	-	-	-	9.6/8.7	-	70.1/72.0	80/80	-	-
											-	-	-	-	-	41.3/40.4	50/50	-	-
											-	-	-	-	-	33.4/33.2	45/45	-	-
											-	-	-	-	-	43.0/41.9	50/50	-	-
											-	-	-	-	-	35.3/39.7	45/45	-	-
											-	-	-	-	-	47.7/50.6	50/60	-	-
											-	-	-	-	-	37.8/41.6	45/45	-	-
											-	-	-	-	-	49.8/52.4	50/60	-	-
											-	-	-	-	-	48.7/54.7	50/60	-	-
											-	-	-	-	-	60.7/65.6	70/70	-	-
											-	-	-	-	-	50.8/56.6	60/60	-	-
											-	-	-	-	-	62.8/67.5	70/70	-	-
											-	-	-	-	-	61.5/69.5	70/70	-	-
											-	-	-	-	-	73.5/80.3	80/90	-	-
											-	-	-	-	-	63.6/71.3	70/80	-	-
DFC0724D	460/3/60	1	8.5	66.1	1	0.33	0.85	Direct Drive Standard Static	1.2	2.5	-	-	-	4.3	-	13.9	20	-	-
											-	-	-	-	-	14.4	20	-	-
											-	-	-	-	-	18.7	25	-	-
											-	-	-	-	-	13.9	20	-	-
											-	-	-	-	-	18.2	25	-	-
											-	-	-	-	-	14.4	20	-	-
											-	-	-	-	-	18.7	25	-	-
											-	-	-	-	-	13.9	20	-	-
											-	-	-	-	-	18.2	25	-	-
											-	-	-	-	-	23.5	25	-	-
											-	-	-	-	-	18.8	20	-	-
											-	-	-	-	-	24.2	25	-	-
											-	-	-	-	-	25.7	30	-	-
											-	-	-	-	-	31.1	35	-	-
											-	-	-	-	-	26.3	30	-	-
-	-	-	-	-	31.7	35	-	-											
-	-	-	-	-	33.2	35	-	-											
-	-	-	-	-	38.6	40	-	-											
-	-	-	-	-	33.8	35	-	-											
-	-	-	-	-	39.2	40	-	-											
-	-	-	-	-	48.2	50	-	-											
-	-	-	-	-	53.6	60	-	-											
-	-	-	-	-	48.9	50	-	-											
-	-	-	-	-	54.2	60	-	-											

APPENDIX B ELECTRICAL DATA

Model Number	Electrical Rating	Compressor			Outdoor Fan Motor			Indoor Fan Motor			Optional Electric Heat			Optional Powered Convenience Outlet	Optional Power Exhaust	Power Supply	
		QTY	RLA	LRA	QTY	HP	FLA	Type	HP	FLA	Part #	KW*	FLA	FLA	FLA	MCA	MOP
DFC0724W	460/3/60	1	8.5	66.1	1	0.33	0.85	Direct Drive High Static	2.3	4.5	-	-	-	-	-	15.9	20
											-	-	-	4.3	-	20.2	25
											-	-	-	-	0.5	16.4	20
											-	-	-	4.3	0.5	20.7	25
											-	-	-	-	-	15.9	20
											EH*D-4S06	5	6.01	4.3	-	20.2	25
														-	0.5	16.4	20
														4.3	0.5	20.7	25
														-	-	20.7	25
														4.3	-	26	30
														-	0.5	21.3	25
											EH*D-4S11	10	12	4.3	-	26.7	30
														-	-	28.2	30
														4.3	-	33.6	35
														-	0.5	28.8	30
														4.3	0.5	34.2	35
														-	-	35.7	40
											EH*D-4S17	15	18	4.3	-	41.1	45
														-	-	41.1	45
														4.3	-	41.1	45
														-	0.5	36.3	40
														4.3	0.5	41.7	45
														-	-	50.7	60
											EH*D-4S23	20	24.1	4.3	-	56.1	60
-	-	56.1	60														
4.3	-	51.4	60														
-	0.5	51.4	60														
4.3	0.5	56.7	60														
-	-	10.6	15														
DFC0727D	575/3/60	1	6.3	55.3	1	0.33	0.67	Direct Drive Standard Static	1.2	2	-	-	-	-	-	10.6	15
											-	-	-	3.5	-	14.1	20
											-	-	-	-	0.6	11.2	15
											-	-	-	3.5	0.6	14.7	20
											-	-	-	-	-	10.6	15
											EH*D-7S06	5	4.81	3.5	-	14.1	20
														-	0.6	11.2	15
														3.5	0.6	14.7	20
														-	-	14.5	15
														3.5	-	18.9	20
														-	0.6	15.3	20
											EH*D-7S11	10	9.62	3.5	0.6	19.7	20
														-	-	20.5	25
														3.5	-	24.9	25
														-	0.6	21.3	25
														3.5	0.6	25.7	30
														-	-	26.6	30
											EH*D-7S17	15	14.4	3.5	-	30.9	35
														-	0.6	27.3	30
														3.5	0.6	31.7	35
														-	-	38.6	40
														3.5	-	43	45
														-	0.6	39.3	40
											EH*D-7S23	20	19.2	3.5	0.6	43.7	45
-	-	12.4	15														
3.5	-	15.9	20														
-	0.6	13	15														
3.5	0.6	16.5	20														
-	-	12.4	15														
EH*D-7S06	5	4.81	3.5	-	15.9	20											
			-	0.6	13	15											
			3.5	0.6	16.5	20											
			-	-	16.8	20											
			3.5	-	21.2	25											
			-	0.6	17.5	20											
EH*D-7S11	10	9.62	3.5	0.6	21.9	25											
			-	-	22.8	25											
			3.5	-	27.2	30											
			-	0.6	23.5	25											
			3.5	0.6	27.9	30											
			-	-	28.8	30											
EH*D-7S17	15	14.4	3.5	-	33.2	35											
			-	0.6	29.6	30											
			3.5	0.6	33.9	35											
			-	-	40.8	45											
			3.5	-	45.2	50											
			-	0.6	41.6	45											
EH*D-7S23	20	19.2	3.5	0.6	46	50											
			-	-	-	-											
			3.5	-	-	-											
			-	0.6	-	-											
			3.5	0.6	-	-											
			-	-	-	-											

APPENDIX C UNIT DIMENSIONS

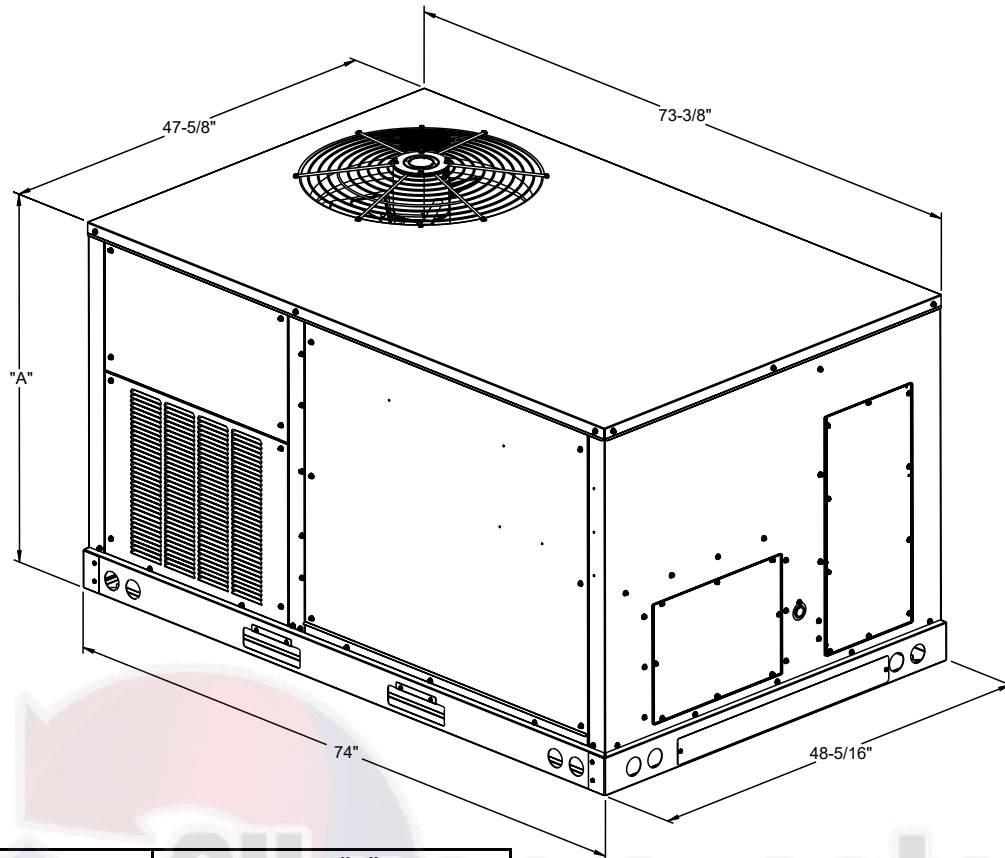

MODEL SIZE	DIM "A"
3 TON	39-7/8"
4 TON	39-7/8"
5 TON	39-7/8"
6 TON	43-1/2"

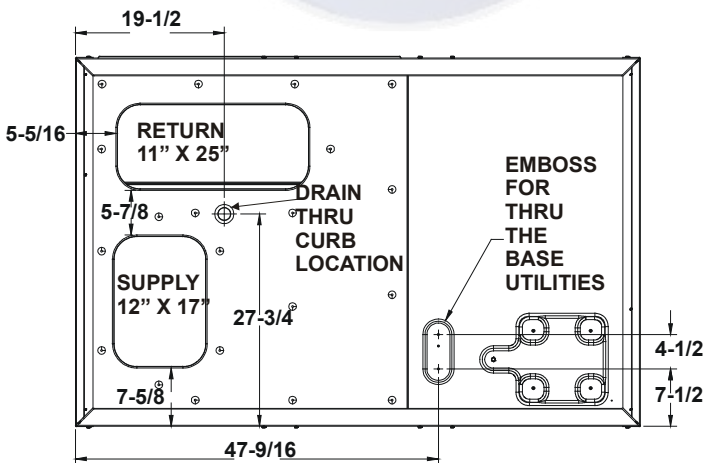

BOTTOM VIEW OF UNIT

VERTICAL DISCHARGE

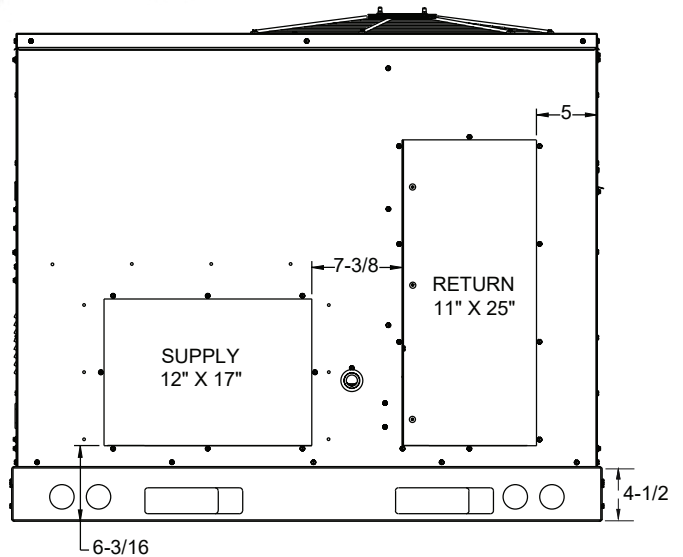

HORIZONTAL DISCHARGE

NOTE: REFER TO IOD-7082 INCLUDED IN THE LITERATURE PACK FOR INSTALLING HORIZONTAL DUCT COVERS.

APPENDIX D AIR FLOW FOR ELECTRIC HEAT

ELECTRIC HEATERS					
UNIT	HEATER KIT MODEL NUMBER	KW	HEATING MINIMUM AIRFLOW	COOLING MINIMUM AIRFLOW	MAXIMUM CFM
3 TON AC STD STATIC	EH*D-*S06	5	1200	900	1500
	EH*D-*S11	10			
	EH*D-*S17	15			
3 TON AC HIGH STATIC	EH*D-*S06	5	1200	900	1500
	EH*D-*S11	10			
	EH*D-*S17	15			
4 TON AC STD STATIC	EH*D-*S06	5	1600	1200	2000
	EH*D-*S11	10			
	EH*D-*S17	15			
	EH*D-*S23	20			
4 TON AC HIGH STATIC	EH*D-*S06	5	1600	1200	2000
	EH*D-*S11	10			
	EH*D-*S17	15			
	EH*D-*S23	20			
5 TON AC STD STATIC	EH*D-*S06	5	1625	1500	2500
	EH*D-*S11	10			
	EH*D-*S17	15			
	EH*D-*S23	20			
5 TON AC HIGH STATIC	EH*D-*S06	5	1625	1500	2500
	EH*D-*S11	10			
	EH*D-*S17	15			
	EH*D-*S23	20			
6 TON AC STD STATIC	EH*D-*S06	5	2000	1800	3000
	EH*D-*S11	10			
	EH*D-*S17	15			
	EH*D-*S23	20			
	EH*D-*S32	30			
6 TON AC HIGH STATIC	EH*D-*S06	5	2400	1800	3000
	EH*D-*S11	10			
	EH*D-*S17	15			
	EH*D-*S23	20			
	EH*D-*S32	30			

HEATER KIT MODEL NUMBER NOMENCLATURE

	EH	X	D	-	3	S	15
	1	2	3	-	4	5	6, 7
Electric Heater							
Heater Type							
X	Staged						
S	SCR (modulating)						
Drive System							
B	Belt Drive						
D	Direct Drive						
Voltage							
1	208-230/1/60	Single phase 60 Hz					
3	208-230/3/60	Three phase 60 Hz					
4	460/3/60	Three phase 60 Hz					
7	575/3/60	Three phase 60 Hz					
Chassis							
S	Small						
M	Medium						
L	Large						
Kilowatt							
5	05 KW						
6	05 KW						
10	10 KW						
11	10 KW						
15	15 KW						
16	15 KW						
17	15 KW						
18	18 KW						
20	20 KW						
21	20 KW						
22	20 KW						
23	20 KW						
30	30 KW						
31	30 KW						
32	30 KW						

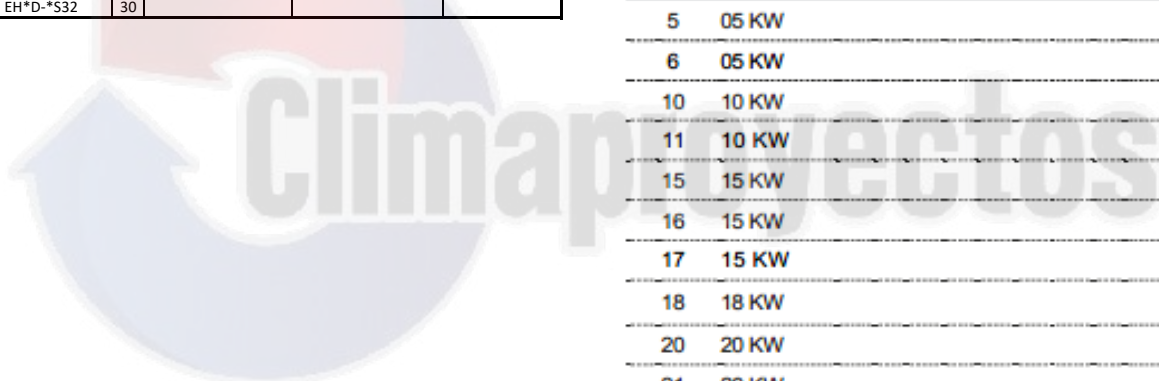

WIRING DIAGRAM

DFC036-060, 1 PHASE, STD STATIC

WARNING

HIGH VOLTAGE!
DISCONNECT ALL POWER BEFORE SERVICING OR INSTALLING THIS UNIT. MULTIPLE POWER SOURCES MAY BE PRESENT. FAILURE TO DO SO MAY CAUSE PROPERTY DAMAGE, PERSONAL INJURY OR DEATH.

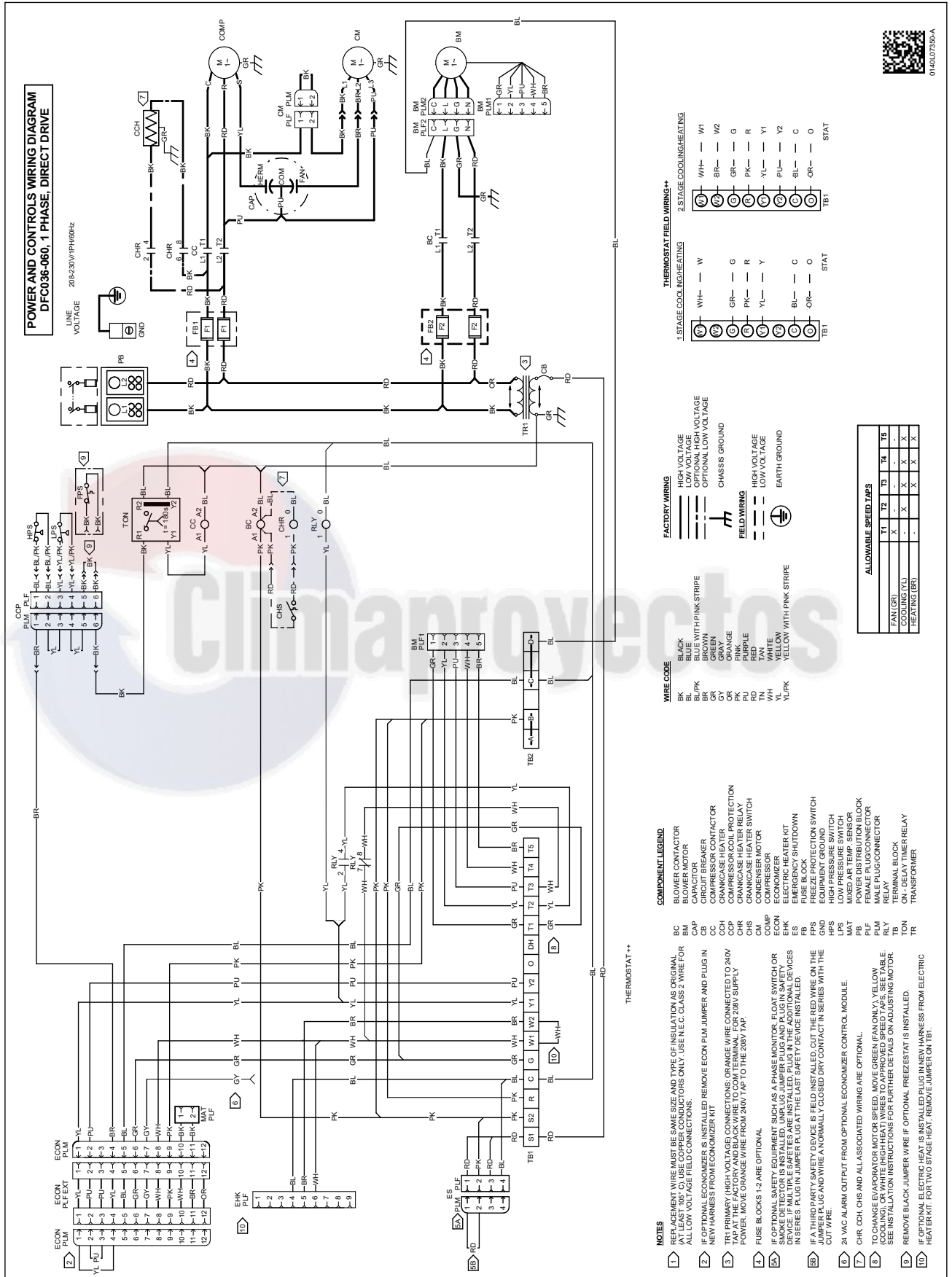

POWER AND CONTROLS WIRING DIAGRAM
DFC036-060, 1 PHASE, DIRECT DRIVE

LINE VOLTAGE
208-230V/1PH/60HZ

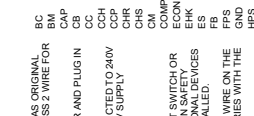
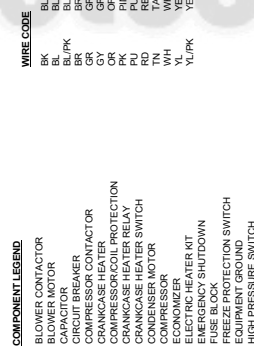
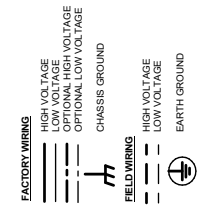
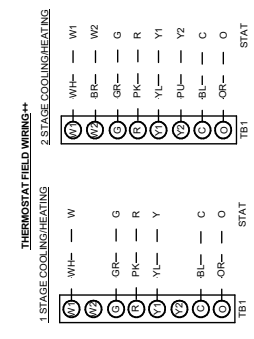

0146107356-A

Wiring is subject to change. Always refer to the wiring diagram on the unit for the most up-to-date wiring.

WARNING

HIGH VOLTAGE!
DISCONNECT ALL POWER BEFORE SERVICING OR INSTALLING THIS UNIT. MULTIPLE POWER SOURCES MAY BE PRESENT. FAILURE TO DO SO MAY CAUSE PROPERTY DAMAGE, PERSONAL INJURY OR DEATH.

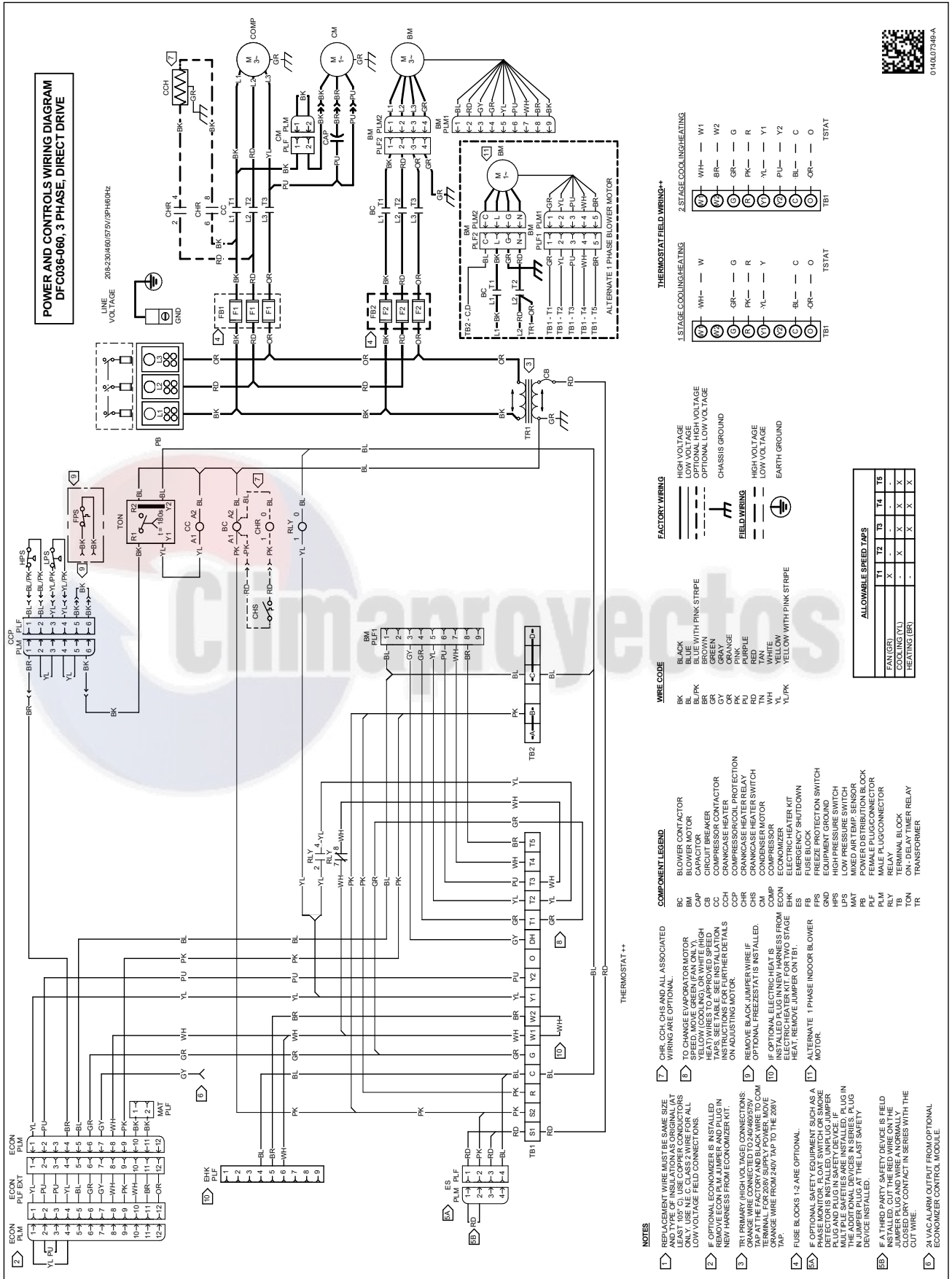

POWER AND CONTROLS WIRING DIAGRAM
DFC036-060, 3 PHASE, DIRECT DRIVE

LINE VOLTAGE 208-230V/60/575/3PH/60HZ

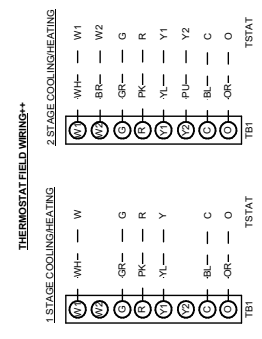

0146L0734B-A

Wiring is subject to change. Always refer to the wiring diagram on the unit for the most up-to-date wiring.

WARNING

HIGH VOLTAGE!
DISCONNECT ALL POWER BEFORE SERVICING OR INSTALLING THIS UNIT. MULTIPLE POWER SOURCES MAY BE PRESENT. FAILURE TO DO SO MAY CAUSE PROPERTY DAMAGE, PERSONAL INJURY OR DEATH.

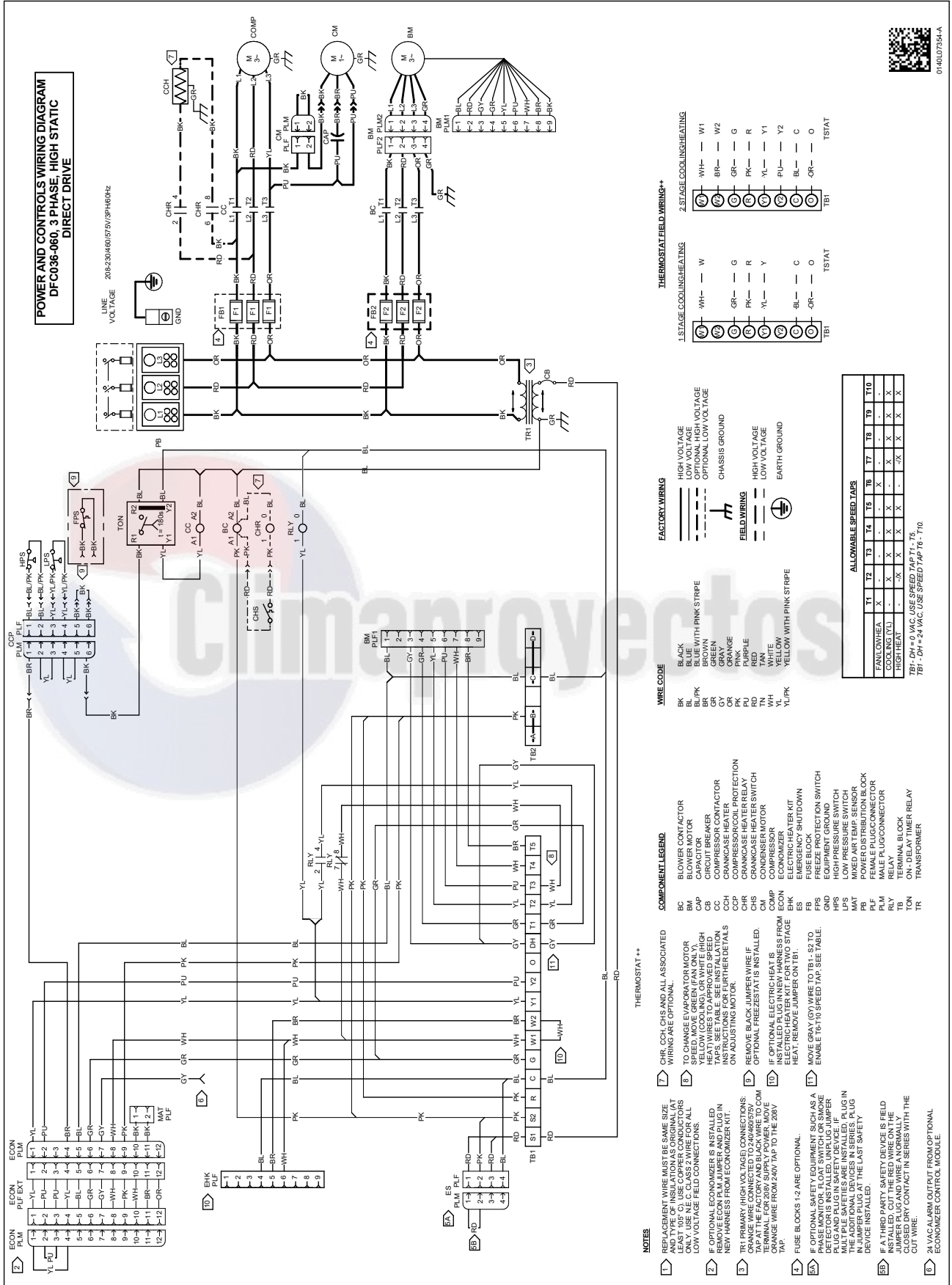

NOTES

1. REFER TO THE WIRING DIAGRAM FOR THE SIZE AND TYPE OF WIRING AND CONDUIT. USE AT LEAST 105°C WIRING. USE COPPER CONDUCTORS ONLY. USE NE C CLASS WIRE FOR ALL LOW VOLTAGE FIELD CONNECTIONS.
2. FORTHOPT LEAD WIRE IS INSTALLED IN NEW HARNESS FROM ECONOMIZER KIT.
3. TR1 PRIMARY (HIGH VOLTAGE) CONNECTIONS: ORANGE WIRE CONNECTED TO 240/460/575V TERMINAL FOR 208V SUPPLY POWER. LOW VOLTAGE WIRE FROM 240V TAP TO THE 208V TAP.
4. IF OPTIONAL ELECTRIC HEAT IS LESS FROM ECONOMIZER KIT, FOR TWO STAGE ELECTRIC HEATER KIT, FOR TWO STAGE HEAT, REMOVE JUMPER ON TB1.
5. FUSE BLOCKS 1,2 ARE OPTIONAL.
6. IF OPTIONAL SAFETY EQUIPMENT SUCH AS A PHASE MONITOR, FLOAT SWITCH OR SMOKE DETECTOR IS INSTALLED, REMOVE JUMPER PLUG AND BURN IN SAFETY DEVICE IF MULTIPLE SAFETIES ARE INSTALLED. PLUG IN JUMPER PLUG AT THE LAST SAFETY DEVICE INSTALLED.
7. IF A THIRD PARTY SAFETY DEVICE IS FIELD INSTALLED, CUT THE RED WIRE ON THE CLOSED DRY CONTACT IN SERIES WITH THE CUT WIRE.
8. 24 VAC ALARM OUTPUT FROM OPTIONAL ECONOMIZER CONTROL MODULE.

COMPONENT LEGEND

BC BLOWER CONTACTOR
BM BLOWER MOTOR
CB CIRCUIT BREAKER
CC COMPRESSOR CONTACTOR
CCH CRANKCASE HEATER
COP COMPRESSOR COIL PROTECTION
CHS CRANKCASE HEATER SWITCH
CM COMPRESSOR MOTOR
COM CONDENSER MOTOR
EON ELECTRIC HEATER KIT
ES EMERGENCY SHUT DOWN
FB FUSE BLOCK
FR FREEZE PROTECTION SWITCH
HPS HIGH PRESSURE SWITCH
LPS LOW PRESSURE SWITCH
MAT MIXED AIR TEMP SENSOR
PE POWER DISCONNECT BLOCK
PLM MALE PLUG CONNECTOR
RLY RELAY
TB1 TERMINAL BLOCK
TR TRANSFORMER

WIRE CODE

BL BLACK
BL/PK BLUE WITH PINK STRIPE
BR BROWN
GR GREEN
OR ORANGE
PK PINK
RD RED
TN TAN
WH WHITE
YL/YLW YELLOW WITH PINK STRIPE

FACTORY WIRING

HIGH VOLTAGE
LOW VOLTAGE
OPTIONAL LOW VOLTAGE
CHASSIS GROUND
HIGH VOLTAGE
EARTH GROUND

FIELD WIRING

1 STAGE COOLING/HEATING

WHI - W
GR - G
PK - R
YL - Y
BL - C
OR - O
TS1

2 STAGE COOLING/HEATING

WHI - W1
BR - W2
GR - G
PK - R
YL - Y1
YL - Y2
BL - C
OR - O
TS1

ALLOWABLE SPEED TAPS

	T1	T2	T3	T4	T5	T6	T7	T8	T9	T10
FAN/LOW HEAT	X	X	X	X	X	X	X	X	X	X
COOLING (Y1)	X	X	X	X	X	X	X	X	X	X
HIGH HEAT	-	-X	-	-	-	-	-X	-	-	-

TB1 - DH = 0 VAC. USE SPEED TAP T1 - T5.
TB1 - DH = 24 VAC. USE SPEED TAP T6 - T10.

Wiring is subject to change. Always refer to the wiring diagram on the unit for the most up-to-date wiring.

WIRING DIAGRAM

DFC072, 3 PHASE, STD & HIGH STATIC

WARNING

HIGH VOLTAGE!
DISCONNECT ALL POWER BEFORE SERVICING OR INSTALLING THIS UNIT. MULTIPLE POWER SOURCES MAY BE PRESENT. FAILURE TO DO SO MAY CAUSE PROPERTY DAMAGE, PERSONAL INJURY OR DEATH.

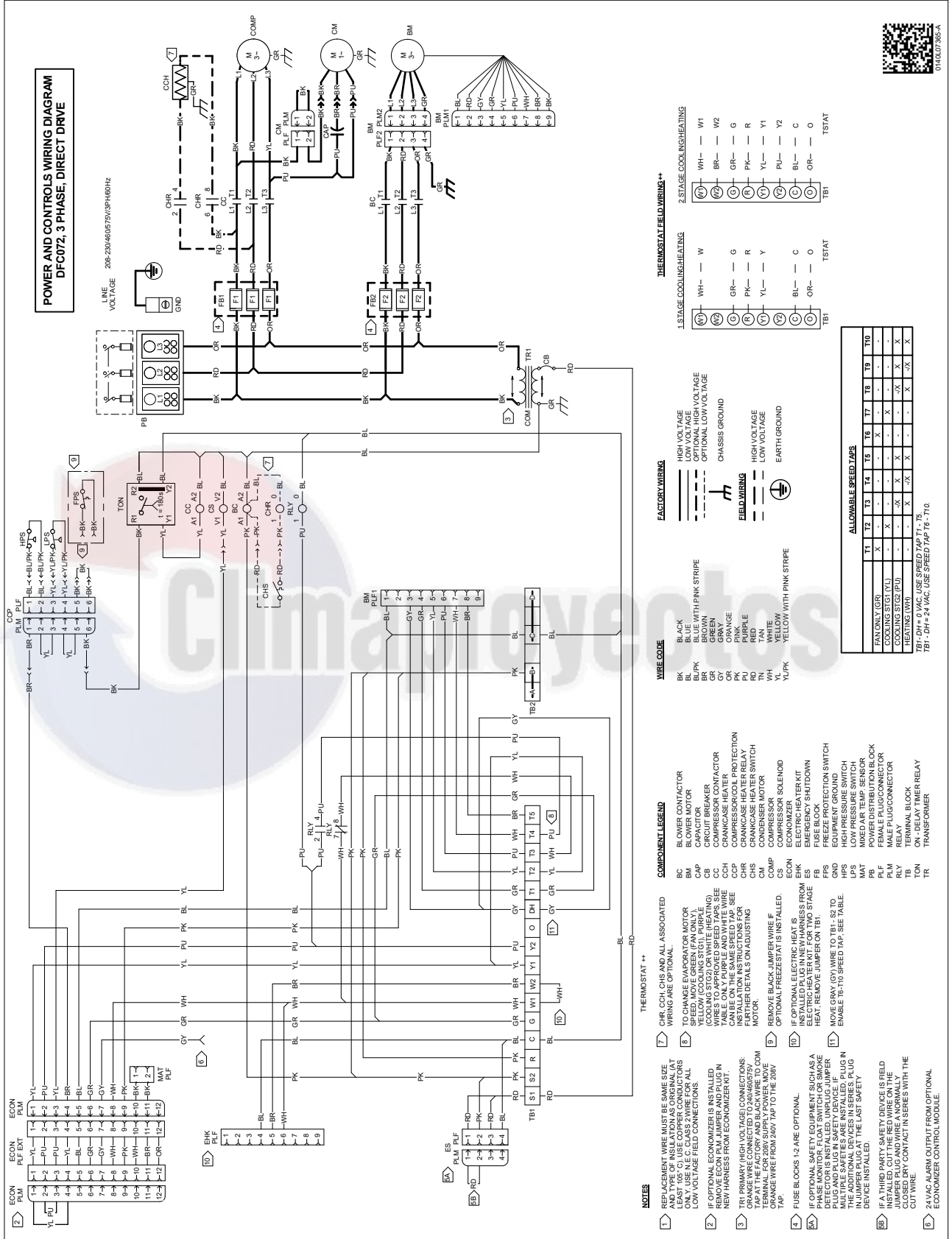

Wiring is subject to change. Always refer to the wiring diagram on the unit for the most up-to-date wiring.

Date: _____ Location: _____
Model Number: _____
Serial Number: _____
Technician: _____ Unit #: _____

Pre Start-Up

(Check each item as completed)

- Verify all packaging material has been removed.
- Remove all shipping brackets per installation instructions.
- Verify the job site voltage agrees with the unit serial plate.
- Verify condensate connection is installed per installation instructions.
- Verify proper clearance around the unit for safety, service, maintenance and proper unit operation.
- Verify proper weatherproofing of all ductwork, roof curbs and electrical connections.
- Check that the flue screen is in place.
- Check gas piping for leaks.
- Verify gas pressure to the unit is within the range specified on the serial plate.
- Check to ensure that all fans, pulleys and wheels are secure.
- Check for proper belt tension and alignment per installation instructions.
- Check refrigerant piping for rubbing and leaks. *Repair if necessary.*
- Check unit wiring to ensure it is not in contact with refrigerant piping or sharp metal edges.
- Check all electrical connections and terminals. *Tighten as needed.*
- Verify that the crankcase heaters have been energized for 24 hours.
- Verify the scroll compressor(s) are rotating in the right direction.
- Verify all accessories are installed and operating correctly.
- Check filters and replace if necessary.
- Verify the installation of the thermostat.



Start-up Checklist

Start-Up
(Insert the values as each item is completed.)

ELECTRICAL

Supply Voltage	L1 - L2	_____	L2 - L3	_____	L3 - L1	_____
Circuit 1 Compressor Amps	L1	_____	L2	_____	L3	_____
Circuit 2 Compressor Amps	L1	_____	L2	_____	L3	_____
Blower Amps	L1	_____	L2	_____	L3	_____
Condenser Fan Amps	Fan 1	_____	Fan 2	_____	Fan 3	_____

BLOWER EXTERNAL STATIC PRESSURE

Return Air Static Pressure	_____	IN. W.C.
Supply Air Static Pressure	_____	IN. W.C.
Total External Static Pressure	_____	IN. W.C.
Blower Wheel RPM	_____	RPM

TEMPERATURES

Outdoor Air Temperature	_____	DB	_____	WB
Return Air Temperature	_____	DB	_____	WB
Cooling Supply Air Temperature	_____	DB	_____	WB
Heating Supply Air Temperature	_____	DB	_____	

PRESSURES

Gas Inlet Pressure	_____	IN. W.C.		
Gas Manifold Pressure	_____	IN. W.C. (Low Fire)	_____	IN. W.C. (High Fire)
Suction Circuit 1	_____	PSIG	_____	°F
Superheat (Orifice System)	_____		_____	°F
Suction Circuit 2	_____	PSIG	_____	°F
Superheat (Orifice System)	_____		_____	°F
Discharge Circuit 1	_____	PSIG	_____	°F
Subcooling (TXV System)	_____		_____	°F
Discharge Circuit 2	_____	PSIG	_____	°F
Subcooling (TXV System)	_____		_____	°F

(HEAT PUMP ONLY)

Suction Circuit 1	_____	PSIG	_____	°F
Suction Circuit 2	_____	PSIG	_____	°F
Discharge Circuit 1	_____	PSIG	_____	°F
Discharge Circuit 2	_____	PSIG	_____	°F

THIS PAGE LEFT INTENTIONALLY BLANK.



CUSTOMER FEEDBACK

Daikin is very interested in all product comments.
Please fill out the feedback form on the following link:

<https://daikincomfort.com/contact-us>

You can also scan the QR code on the right to be directed to the feedback page.



Our continuing commitment to quality products may mean a change in specifications without notice.

© 2021 **DAIKIN MANUFACTURING COMPANY, L.P.**

19001 Kermier Rd. Waller, TX 77484

www.daikincomfort.com