

DAIKIN Service Instructions

**Base Efficiency (DB* series) 3-25 Ton, High Efficiency (DR* series) 3-12.5 Ton,
and 2023 Standard Efficiency (DF* series)
Commercial Packaged Units with 410A Refrigerant**



WARNING

ONLY PERSONNEL THAT HAVE BEEN TRAINED TO INSTALL, ADJUST, SERVICE OR REPAIR (HEREINAFTER, "SERVICE") THE EQUIPMENT SPECIFIED IN THIS MANUAL SHOULD SERVICE THE EQUIPMENT. THE MANUFACTURER WILL NOT BE RESPONSIBLE FOR ANY INJURY OR PROPERTY DAMAGE ARISING FROM IMPROPER SERVICE OR SERVICE PROCEDURES. IF YOU SERVICE THIS UNIT, YOU ASSUME RESPONSIBILITY FOR ANY INJURY OR PROPERTY DAMAGE WHICH MAY RESULT. IN ADDITION, IN JURISDICTIONS THAT REQUIRE ONE OR MORE LICENSES TO SERVICE THE EQUIPMENT SPECIFIED IN THIS MANUAL, ONLY LICENSED PERSONNEL SHOULD SERVICE THE EQUIPMENT. IMPROPER INSTALLATION, ADJUSTMENT, SERVICING OR REPAIR OF THE EQUIPMENT SPECIFIED IN THIS MANUAL, OR ATTEMPTING TO INSTALL, ADJUST, SERVICE OR REPAIR THE EQUIPMENT SPECIFIED IN THIS MANUAL WITHOUT PROPER TRAINING MAY RESULT IN PRODUCT DAMAGE, PROPERTY DAMAGE, PERSONAL INJURY OR DEATH.

TABLE OF CONTENTS

IMPORTANT INFORMATION.....	2
SYSTEM OPERATION.....	3
CONTROL BOX AND COMPONENT LOCATIONS.....	7
TROUBLESHOOTING FLOWCHARTS.....	17
ELECTRICAL TROUBLESHOOTING.....	18
ELECTRICAL SERVICING TABLE OF CONTENTS.....	27
REFRIGERANT TROUBLESHOOTING.....	35
REFRIGERANT SERVICING TABLE OF CONTENTS.....	36
IGNITION CONTROL BOARD (PCBAG123)	
TROUBLESHOOTING.....	46
GAS HEAT SERVICING TABLE OF CONTENTS.....	60
ACCESSORIES.....	74
ECONOMIZER (JADE).....	75
SMOKE DETECTOR.....	90
WIRING DIAGRAMS DBC UNITS.....	91
WIRING DIAGRAMS DBH UNITS.....	105
WIRING DIAGRAMS DBG UNITS.....	111
WIRING DIAGRAMS DFC UNITS.....	129
WIRING DIAGRAMS DFG UNITS.....	133
WIRING DIAGRAMS DRC UNITS.....	144
WIRING DIAGRAMS DRG UNITS.....	155
WIRING DIAGRAMS DRH UNITS.....	173
SCHEDULED MAINTENANCE.....	178

This manual is to be used by qualified, professionally trained HVAC technicians only. Daikin does not assume any responsibility for property damage or personal injury due to improper service procedures or services performed by an unqualified person.

RSD6412025r5
March 2022

IMPORTANT INFORMATION

IMPORTANT NOTICES

RECOGNIZE SAFETY SYMBOLS, WORDS AND LABELS

 **WARNING**

TO PREVENT THE RISK OF PROPERTY DAMAGE, PERSONAL INJURY, OR DEATH, DO NOT STORE COMBUSTIBLE MATERIALS OR USE GASOLINE OR OTHER FLAMMABLE LIQUIDS OR VAPORS IN THE VICINITY OF THIS APPLIANCE.

 **WARNING**

HIGH VOLTAGE
DISCONNECT ALL POWER BEFORE SERVICING OR INSTALLING THIS UNIT. MULTIPLE POWER SOURCES MAY BE PRESENT. FAILURE TO DO SO MAY CAUSE PROPERTY DAMAGE, PERSONAL INJURY OR DEATH.



 **WARNING**

THIS UNIT SHOULD NOT BE CONNECTED TO, OR USED IN CONJUNCTION WITH, ANY DEVICES THAT ARE NOT DESIGN CERTIFIED FOR USE WITH THIS UNIT OR HAVE NOT BEEN TESTED AND APPROVED BY THE MANUFACTURER. SERIOUS PROPERTY DAMAGE OR PERSONAL INJURY, REDUCED UNIT PERFORMANCE AND/OR HAZARDOUS CONDITIONS MAY RESULT FROM THE USE OF DEVICES THAT HAVE NOT BEEN APPROVED OR CERTIFIED BY THE MANUFACTURER.

SAFE REFRIGERANT HANDLING

While these items will not cover every conceivable situation, they should serve as a useful guide.

 **WARNING**

THE COMPRESSOR POE OIL FOR R-410A UNITS IS EXTREMELY SUSCEPTIBLE TO MOISTURE ABSORPTION AND COULD CAUSE COMPRESSOR FAILURE. DO NOT LEAVE SYSTEM OPEN TO ATMOSPHERE ANY LONGER THAN NECESSARY FOR INSTALLATION.

 **WARNING**

REFRIGERANTS ARE HEAVIER THAN AIR. THEY CAN “PUSH OUT” THE OXYGEN IN YOUR LUNGS OR IN ANY ENCLOSED SPACE. TO AVOID POSSIBLE DIFFICULTY IN BREATHING OR DEATH:

- NEVER PURGE REFRIGERANT INTO AN ENCLOSED ROOM OR SPACE. BY LAW, ALL REFRIGERANT MUST BE RECLAIMED.
- IF AN INDOOR LEAK IS SUSPECTED, THOROUGHLY VENTILATE THE AREA BEFORE BEGINNING WORK.
- LIQUID REFRIGERANT CAN BE VERY COLD. TO AVOID POSSIBLE FROSTBITE OR BLINDNESS, AVOID CONTACT WITH REFRIGERANT AND WEAR GLOVES AND GOGGLES. IF LIQUID REFRIGERANT DOES CONTACT YOUR SKIN OR EYES, SEEK MEDICAL HELP IMMEDIATELY.
- ALWAYS FOLLOW EPA REGULATIONS. NEVER BURN REFRIGERANT, AS POISONOUS GAS WILL BE PRODUCED.

 **WARNING**

TO AVOID POSSIBLE INJURY, EXPLOSION OR DEATH, PRACTICE SAFE HANDLING OF REFRIGERANTS.

 **WARNING**

TO AVOID POSSIBLE EXPLOSION:

- NEVER APPLY FLAME OR STEAM TO A REFRIGERANT CYLINDER. IF YOU MUST HEAT A CYLINDER FOR FASTER CHARGING, PARTIALLY IMMERSE IT IN WARM WATER.
- NEVER FILL A CYLINDER MORE THAN 80% FULL OF LIQUID REFRIGERANT.
- NEVER ADD ANYTHING OTHER THAN R-22 TO AN R-22 CYLINDER OR R-410A TO AN R-410A CYLINDER. THE SERVICE EQUIPMENT USED MUST BE LISTED OR CERTIFIED FOR THE TYPE OF REFRIGERANT USED.
- STORE CYLINDERS IN A COOL, DRY PLACE. NEVER USE A CYLINDER AS A PLATFORM OR A ROLLER.

 **WARNING**

TO AVOID POSSIBLE EXPLOSION, USE ONLY RETURNABLE (NOT DISPOSABLE) SERVICE CYLINDERS WHEN REMOVING REFRIGERANT FROM A SYSTEM.

- ENSURE THE CYLINDER IS FREE OF DAMAGE WHICH COULD LEAD TO A LEAK OR EXPLOSION.
- ENSURE THE HYDROSTATIC TEST DATE DOES NOT EXCEED 5 YEARS.
- ENSURE THE PRESSURE RATING MEETS OR EXCEEDS 400 LBS.

WHEN IN DOUBT, DO NOT USE CYLINDER.

OUTSIDE THE U.S., call 1-713-861-2500.

(Not a technical assistance line for dealers.) Your telephone company will bill you for the call.

SYSTEM OPERATION

NORMAL SEQUENCE OF OPERATION – HEATING

This unit has one (RS) Manual Reset Limit Control Switch. Check the limit to make sure it has not tripped. The limit may arrive at the job site tripped as a result of shipping shock.

If the vent motor comes on, but the unit does not attempt ignition, check if the ALS (Automatic Reset High Limit Control Switch) requires resetting.

1. With electricity and gas turned on, the system switch in the “HEAT” or “AUTO” position and the fan switch in the “AUTO” position, the thermostat will close the circuit between unit terminals R and W (R-W) when the temperature falls below the thermostat setting.
2. D1 on IIC energizes relay VMR.
3. Relay VMR energizes the vent motor.
4. Operation of the vent motor closes the pressure switch PS located in the burner compartment. The control then initiates a 15-second pre-purge time delay. During this period, the vent motor will clear the combustion chamber of any residual gas.
5. After the pre-purge period, the ignition control energizes the WI-C gas valve and simultaneously initiates a “three (3)-try” spark ignition sequence.
6. When the burners are ignited, a minimum four (4) micro-amp DC current will flow through the flame between the sensor electrode and the grounded burner.
7. When the controller proves that the flame has been established, it will keep the gas valve energized and discontinue the ignition spark. First stage manifold pressure will be approximately 2.0” w.c. for natural gas and 7.0” w.c. for propane (LP).
8. If the control is unable to ignite the burners after its initial attempt, it will initiate another purge and spark sequence. A third purge and spark sequence will be initiated if the second attempt is unsuccessful. If the third attempt is unsuccessful, the controller will close the gas valve and lock itself out. It may be reset by momentarily interrupting power. This may be accomplished by briefly lowering the room thermostat set-point below room temperature, or by shutting off the main power to the unit. (See TP-105 for more details.)
9. Integrated ignition control will close its normally open contacts after a delay of approximately 30 seconds. This action energizes contactor BC and starts the supply fan motor. Operation of the supply fan circulates air across the heat exchanger and delivers heated air to the conditioned space.

10. When the space temperature rises, the thermostat will open R-W. Opening R-W will cause the gas valve to close, and the furnace to shut down.
11. The furnace has three high temperature limit controls, which can shut down the burner. They do not shut down the vent motor.

UNIT SHUTDOWN

1. Set the thermostat to lowest setting.
2. Turn off the electrical power supply to the unit.
3. Remove the heat exchanger door on the side of the unit by removing screws.
4. Move the gas control valve switch to the OFF position. Do not force.
5. Close manual gas shut off valve external to the unit.
6. Replace the heat exchanger door on the unit.
7. If cooling and/or air circulation will be desired, turn ON the electrical power.

NORMAL SEQUENCE OF OPERATION – COOLING

REFRIGERATION SEQUENCE CHECK

With the disconnect switch open, remove the field connected thermostat wire from terminal R on TB1 terminal block. Place a jumper across terminals R and G, and across R and Y1 on TB1 terminal block. On 6-25 ton systems place a jumper on Y1 and Y2 to engage 2nd stage of cooling. Close the disconnect switch. The following operational sequence should be observed.

1. Current through primary winding of transformer TRANS1 energizes the 24-volt control circuit. The control voltage is passed through any installed safety shutdown devices such as the smoke detector before providing 24VAC to TB1.
2. To simulate a mechanical call for cooling from the wall thermostat, place a jumper across terminals R and Y1 of terminal block TB1. Add a jumper from Y1 to Y2 for high stage cooling.
3. **UNIT WITH ECONOMIZER OPTION:** The compressor circuit is interlocked through terminals 3 and 4 of the economizer module. If the outdoor air enthalpy (temperature and humidity) is not suitable for cooling, the economizer terminals will be closed permitting compressor to be energized.
4. The blower motor is operated to provide cool supply air to the space.

SYSTEM OPERATION

For 3 phase belt drive motors: Check supply fan rotation. If the supply fan is rotating in the wrong direction, disconnect and lock off Single Point Power Block. Do not attempt to change load side wiring. Internal wiring is set at the factory to assure that the supply fan and compressors all rotate in the proper direction. Verification of correct supply fan rotation at initial startup will also indicate correct compressor rotation. Reconnect power and check for proper operation.

5. Compressor contactor closes its contacts to provide power to the compressor motor. In addition, the condenser fan motor is energized through the compressor contactor.

Check that each compressor is operating correctly. The scroll compressors in these units **MUST** operate in the proper rotation. To ensure the compressors are operating in the correct direction, check the compressor discharge line pressure or temperature after each compressor is started. The discharge pressure and discharge line temperature should increase. If this does not occur and the compressor is producing an exceptional amount of noise, perform the following checks.

- Ensure all compressors and the supply fan motor are operating in the proper direction. If a single motor is operating backwards, check the power wiring for that motor and correct any leads that have been interchanged at the contactor or at the motor.
 - If all the motors are operating backward, disconnect the unit power supply and lock it in the "OFF" position. Switch two leads of the power supply at the unit Single Point Power Block. Reconnect power and check for compressor and supply fan motor operation.
6. With all safety devices closed, the system will continue cooling operation until the thermostat is satisfied.
 7. Disconnecting the jumper wire between R and Y1 and Y2 and between R and G on TB1 terminal block will simulate a satisfied thermostat. The compressors will cycle off and IIC (pin 12) will initiate its time delay cycle. The compressor and the supply fan will cycle off.
 8. After a time delay of approximately 3 minutes, the compressor control circuits will be ready to respond to a subsequent call for cooling from the wall thermostat.
 9. Open disconnect switch. Reconnect the field thermostat wire at terminal R on terminal block TB1.

HEAT PUMP OPERATION

COOLING CYCLE

When the heat pump is in the cooling cycle, it operates exactly as a Summer Air Conditioner unit. In this mode, all the charts and data for service that apply to summer air conditioning apply to the heat pump. Most apply on the heating cycle except that "condenser" becomes "evaporator", "evaporator" becomes "condenser", "cooling" becomes "heating".

HEATING CYCLE

The heat pump operates in the heating cycle by redirecting refrigerant flow through the refrigerant circuit external to the compressor. This is accomplished with through the reversing valve. Hot discharge vapor from the compressor is directed to the indoor coil (evaporator on the cooling cycle) where the heat is removed, and the vapor condenses to liquid. It then goes through the expansion device to the outdoor coil (condenser on the cooling cycle) where the liquid is evaporated, and the vapor goes to the compressor.

When the solenoid valve coil is operated either from heating to cooling or vice versa, the piston in the reversing valve to the low pressure (high pressure) reverse positions in the reversing valve.

The following figures show a schematic of a heat pump on the cooling cycle and the heating cycle. In addition to a reversing valve, a heat pump is equipped with an expansion device and check valve for the indoor coil, and similar equipment for the outdoor coil. It is also provided with a defrost control system.

The expansion devices are flowrator distributors and perform the same function on the heating cycle as on the cooling cycle. The flowrator distributors also act as check valves to allow for the reverse of refrigerant flow.

SYSTEM OPERATION

When the heat pump is on the heating cycle, the outdoor coil is functioning as an evaporator. The temperature of the refrigerant in the outdoor coil must be below the temperature of the outdoor air in order to extract heat from the air. Thus, the greater the difference in the outdoor temperature and the outdoor coil temperature, the greater the heating capacity of the heat pump. This phenomenon is a characteristic of a heat pump. It is a good practice to provide supplementary heat for all heat pump installations in areas where the temperature drops below 45° F. It is also a good practice to provide sufficient supplementary heat to handle the entire heating requirement should there be a component failure of the heat pump, such as a compressor, or refrigerant leak, etc.

Since the temperature of the refrigerant in the outdoor coil on the heating cycle is generally below freezing point, frost forms on the surfaces of the outdoor coil under certain weather conditions of temperature and relative humidity. Therefore, it is necessary to reverse the flow of the refrigerant to provide hot gas in the outdoor coil to melt the frost accumulation. This is accomplished by reversing the heat pump to the cooling cycle. At the same time, the outdoor fan stops to hasten the temperature rise of the outdoor coil and lessen the time required for defrosting. The indoor blower continues to run, and the supplementary heaters are energized.

DEFROST CONTROL

NOTE: DBH models have one stage of mechanical heating. The defrost accumulation period will start when either first or second stage defrost thermostat closes. Defrost termination occurs when both thermostats open or the 10 minute cycle has completed.

During operation the power to the circuit board is controlled by a temperature sensor, which is clamped to a feeder tube entering the outdoor coil. Defrost timing periods of 30,60 and 90 minutes may be selected by connecting the circuit board jumper to 30, 60 and 90 respectively. Accumulation of time for the timing period selected starts when the sensor closes (approximately 31° F), and when the wall thermostat calls for heat. At the end of the timing period, the unit's defrost cycle will be initiated provided the sensor remains closed. When the sensor opens (approximately 75° F), the defrost cycle is terminated and the timing period is reset. If the defrost cycle is not terminated due to the sensor temperature, a ten minute override interrupts the unit's defrost period.

SYSTEM OPERATION

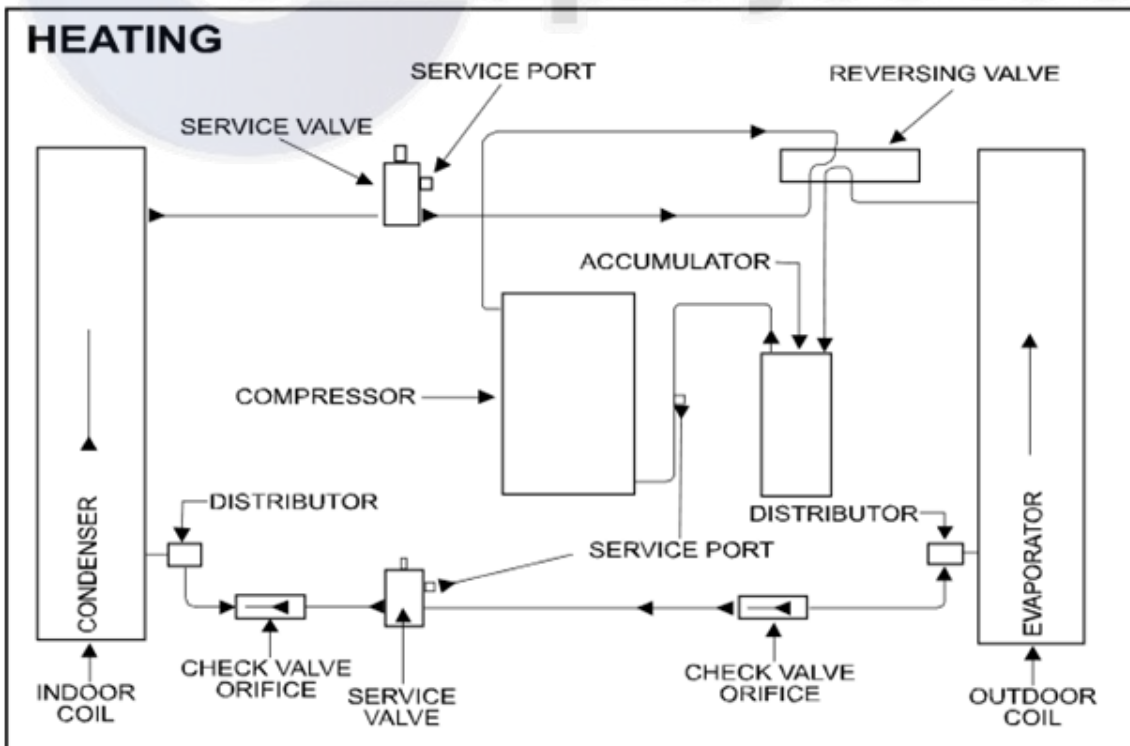
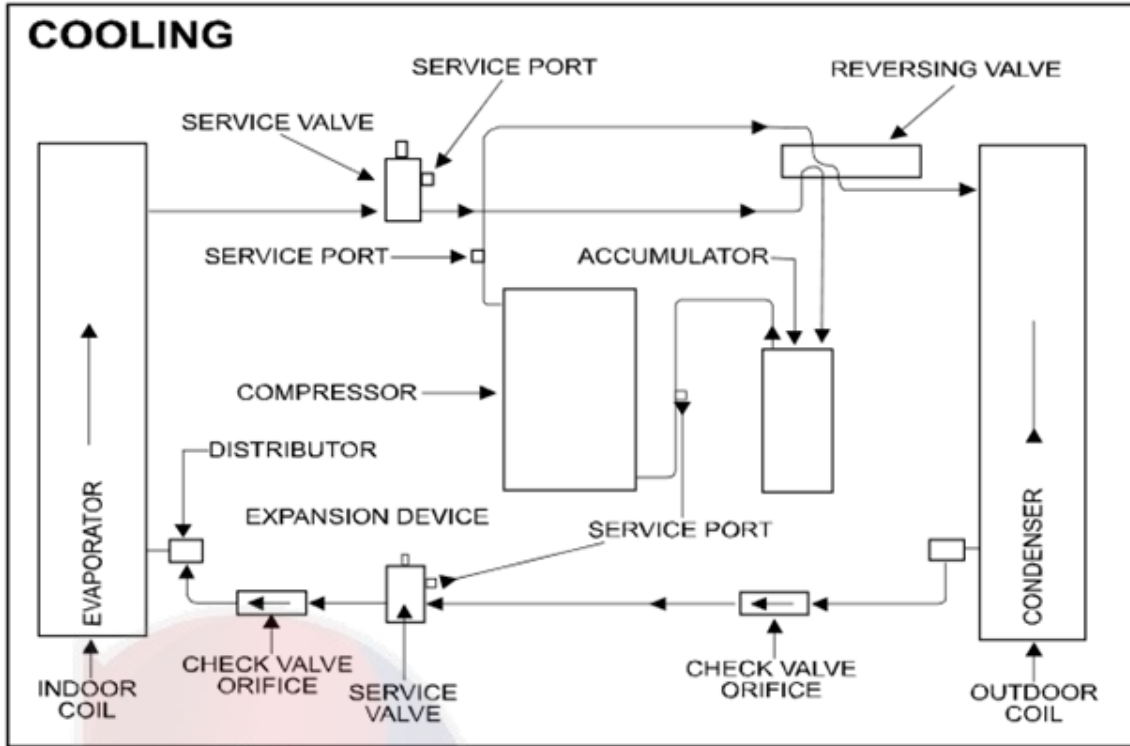

CONTROL BOX AND COMPONENT LOCATIONS



CONTROL BOX AND COMPONENT LOCATIONS

3 TO 6 TON CONTROL BOX

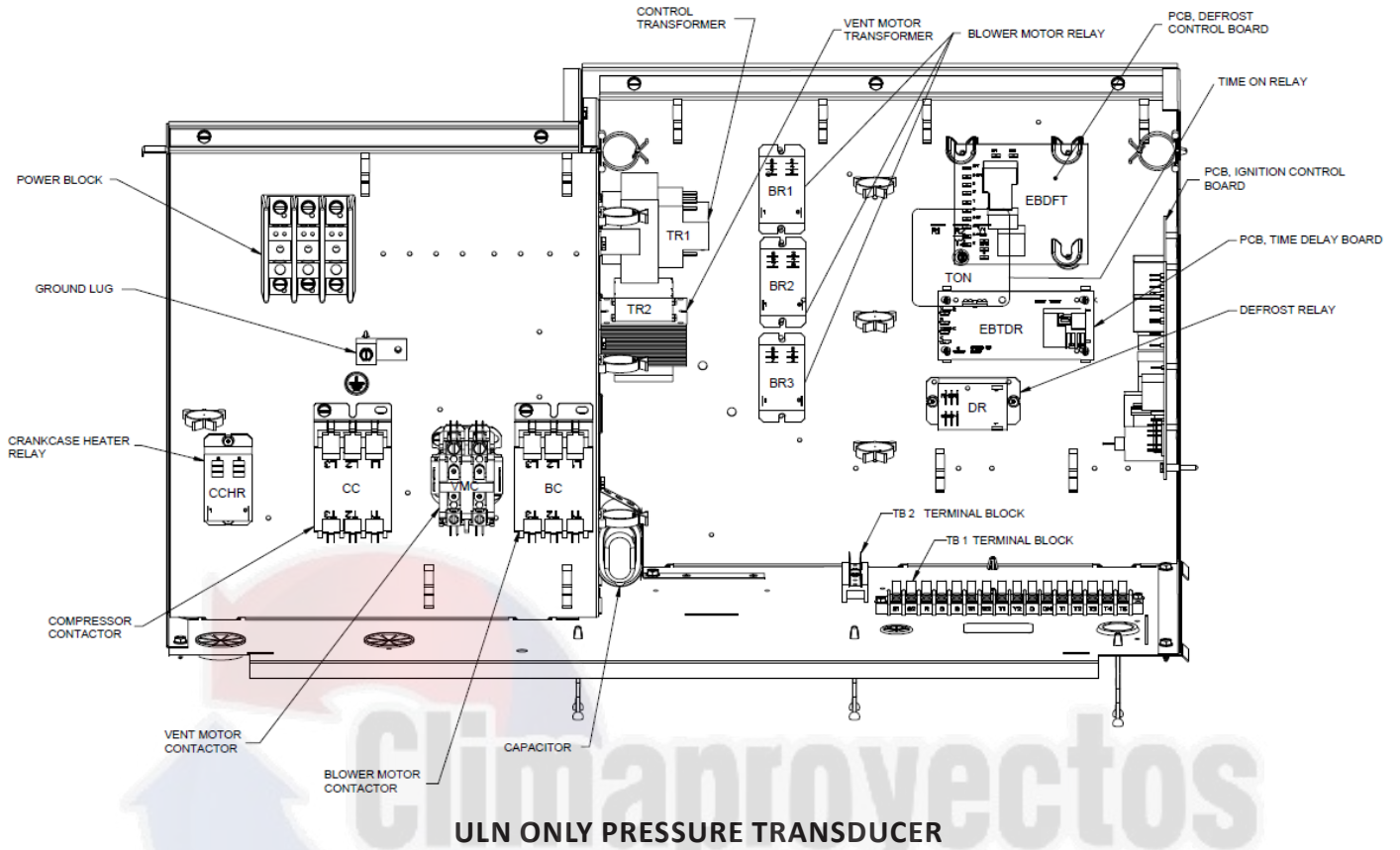

NOTE: All components shown are included with every product.

CONTROL BOX AND COMPONENT LOCATIONS

7.5 TO 12.5 TON CONTROL BOX



NOTE: All components shown are included with every product.

CONTROL BOX AND COMPONENT LOCATIONS

7.5 TO 12.5 TON CONTROL BOX

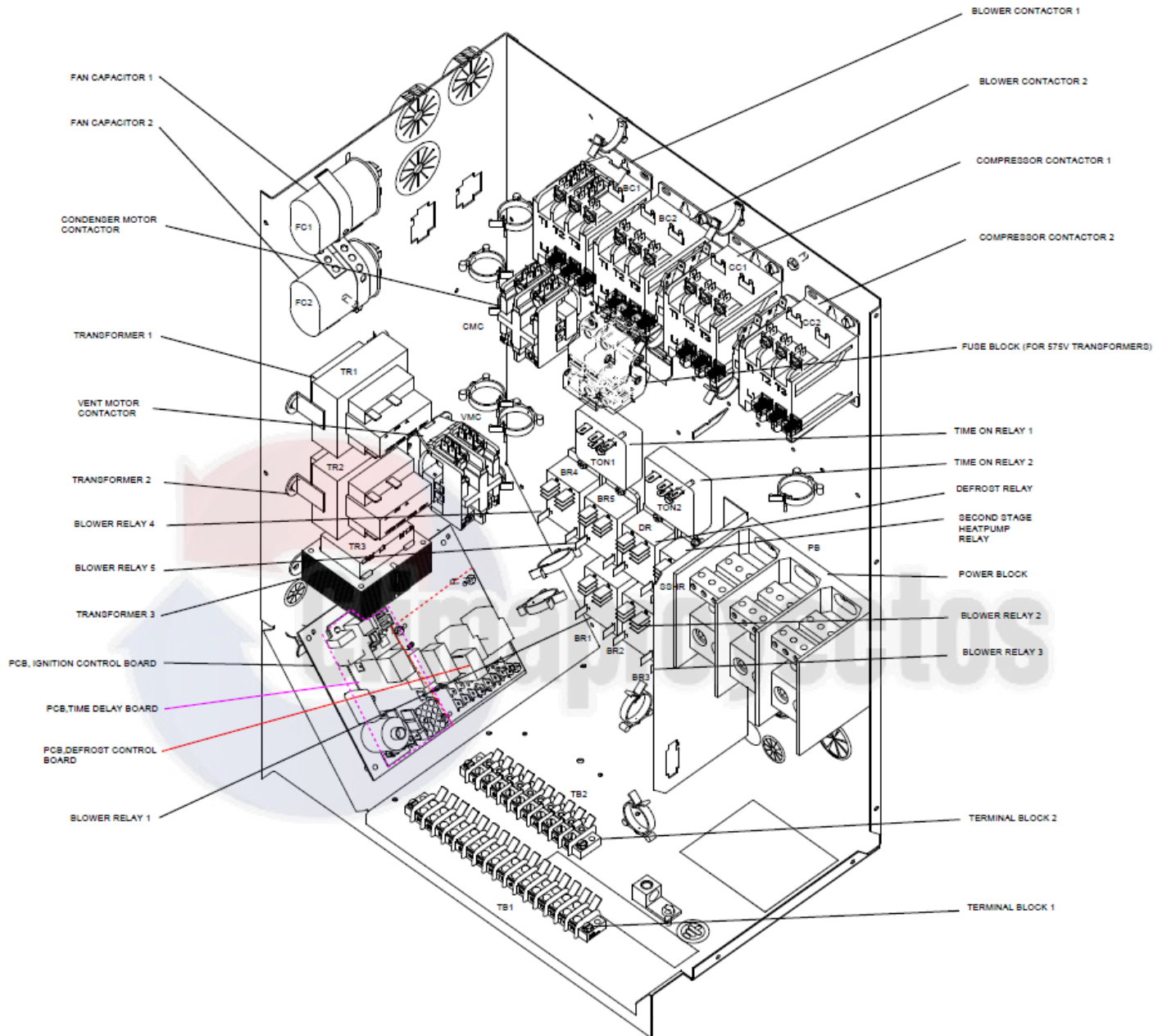

NOTE: All components shown are included with every product.

CONTROL BOX AND COMPONENT LOCATIONS

15 TO 20 TON CONTROL BOX

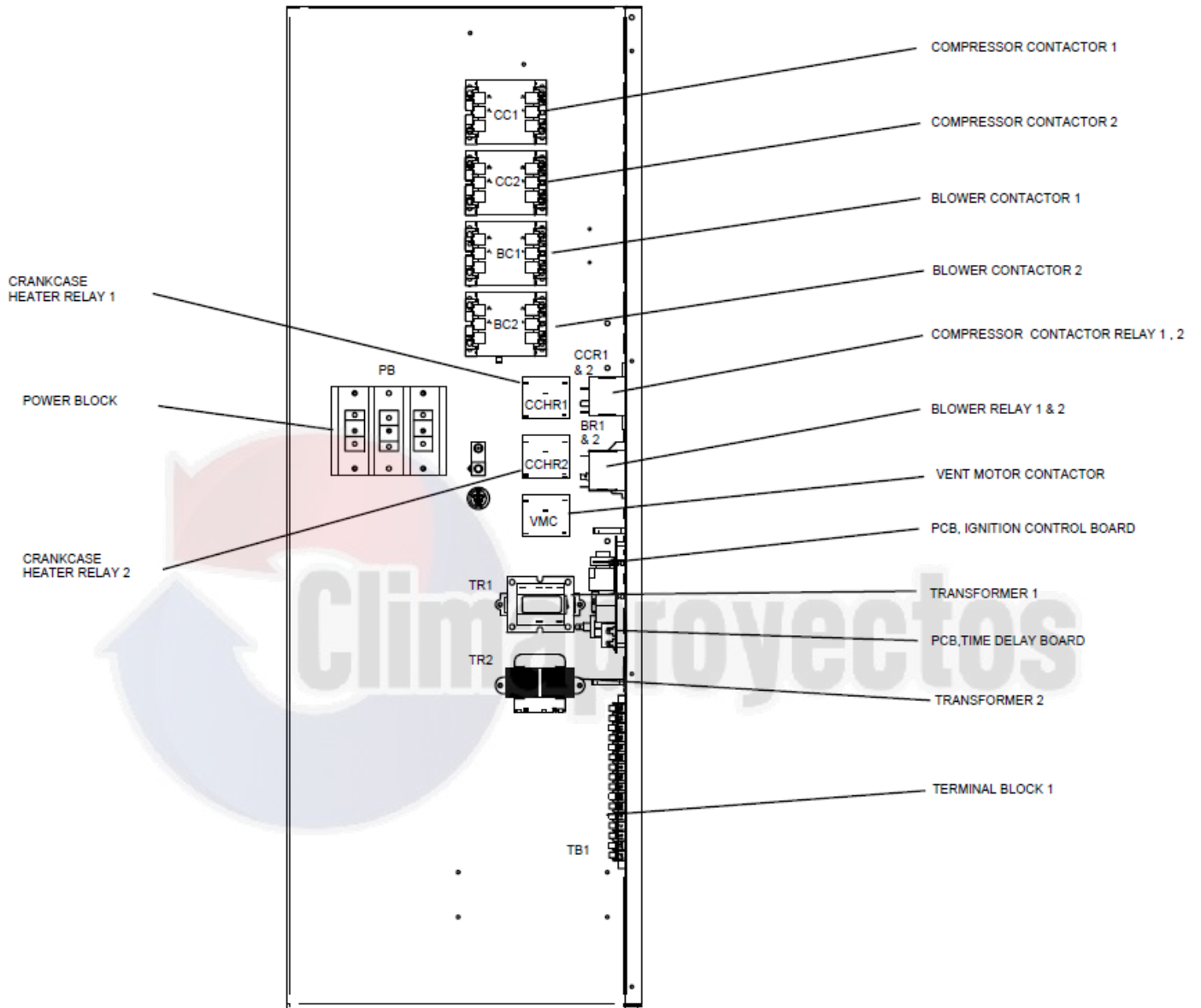

NOTE: All components shown are included with every product.

CONTROL BOX AND COMPONENT LOCATIONS

15 TO 20 TON CONTROL BOX

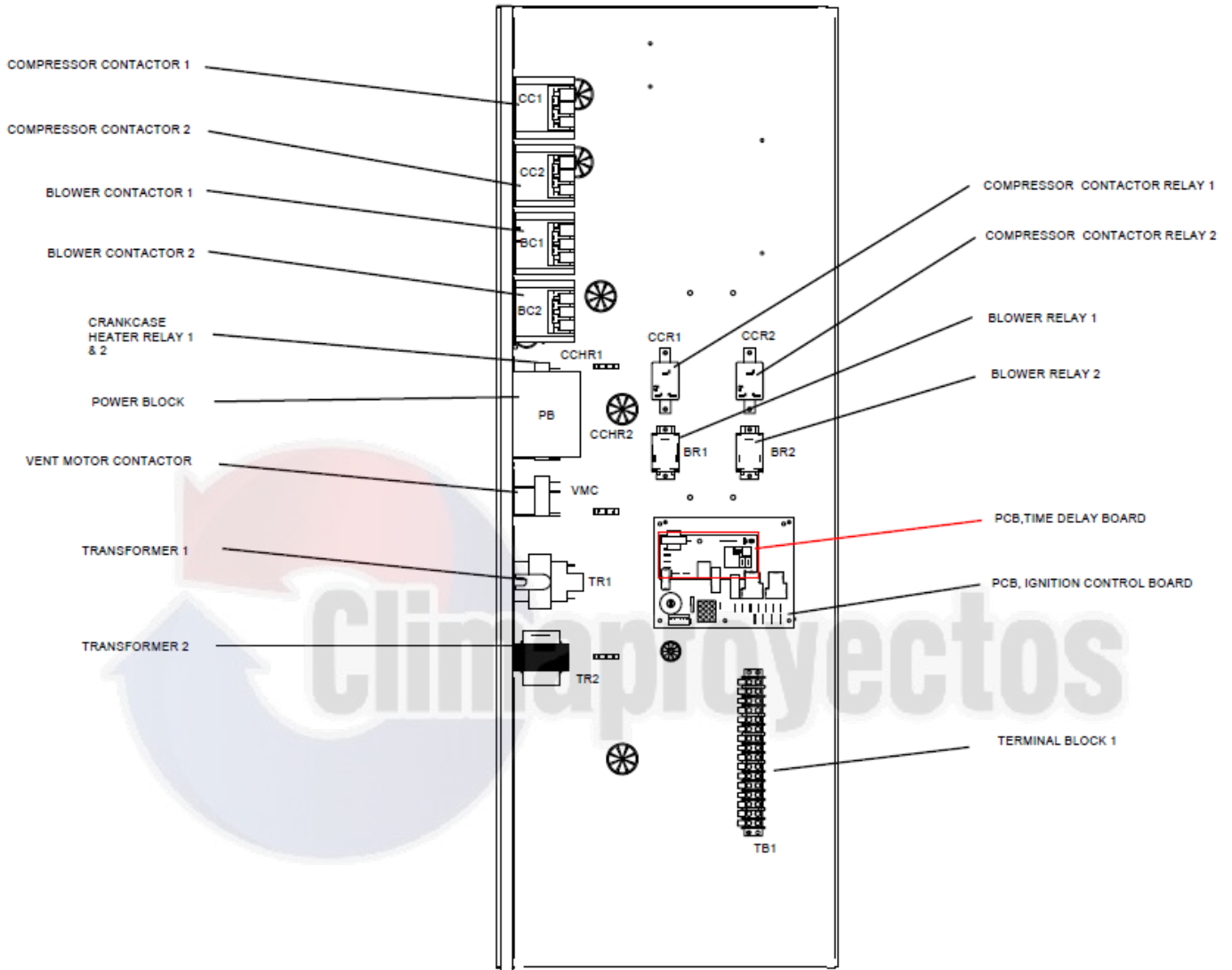

NOTE: All components shown are included with every product.

CONTROL BOX AND COMPONENT LOCATIONS

15 TO 20 TON CONTROL BOX

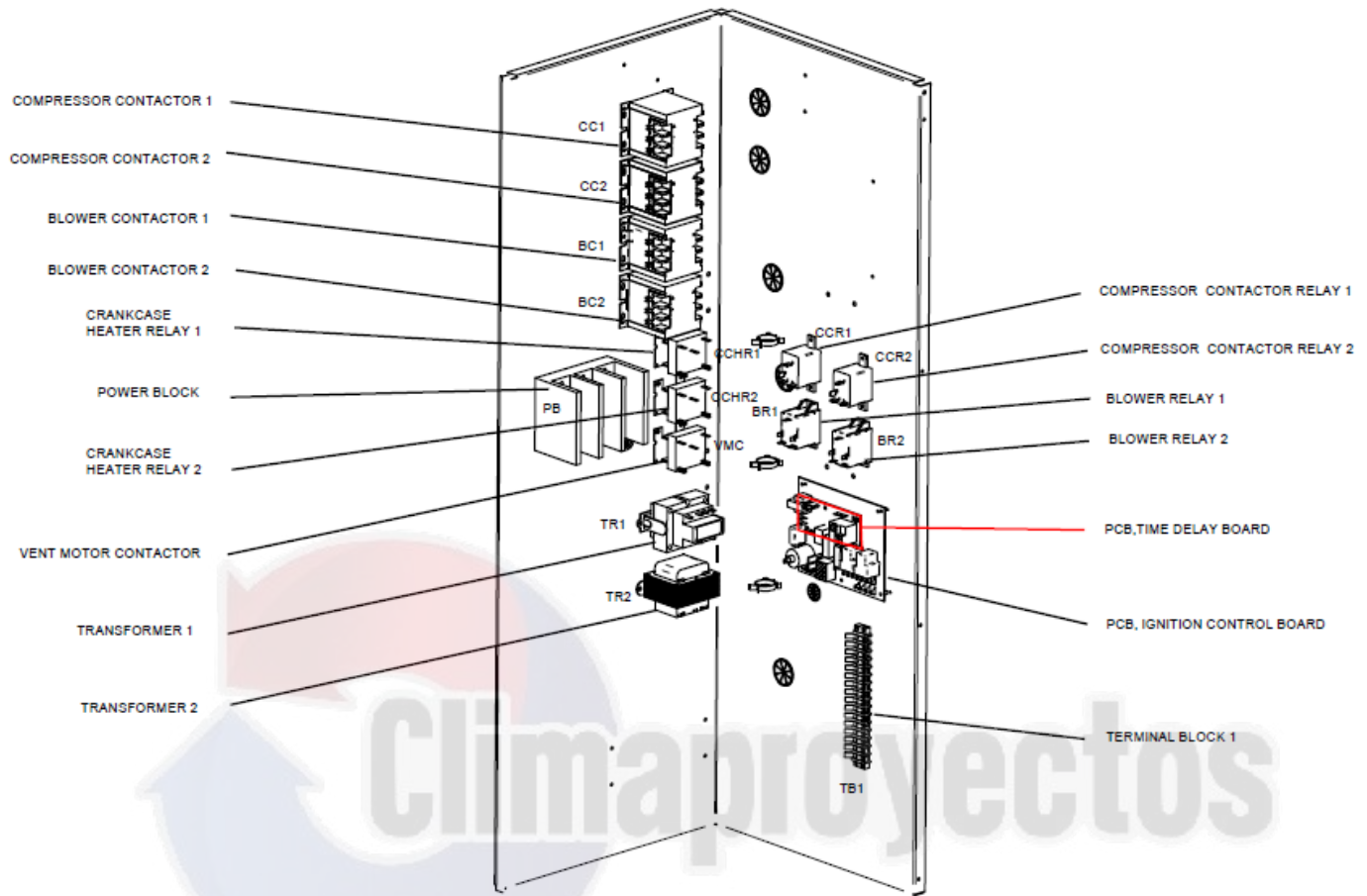

NOTE: All components shown are included with every product.

CONTROL BOX AND COMPONENT LOCATIONS

25 TON CONTROL BOX

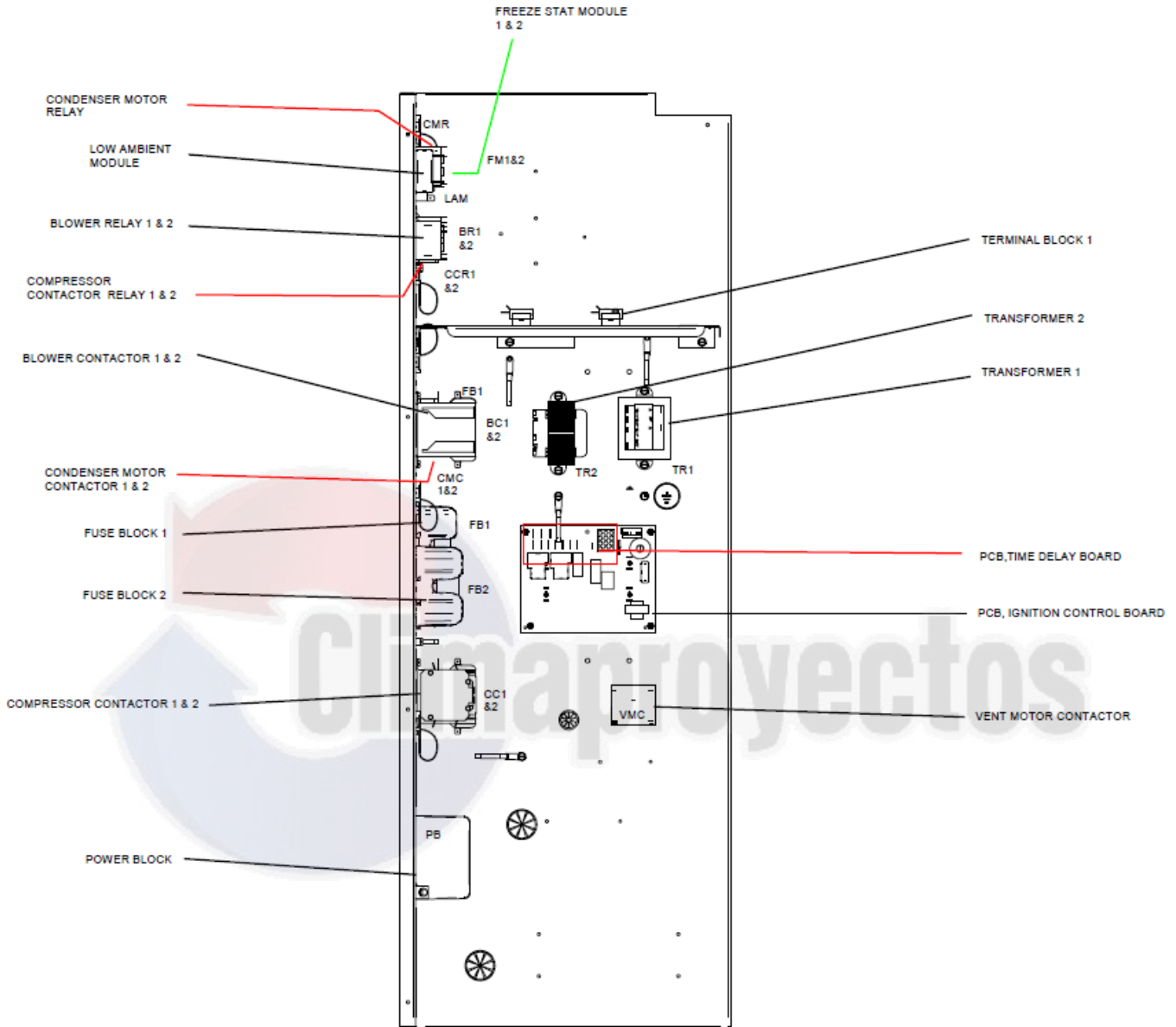

NOTE: All components shown are included with every product.

CONTROL BOX AND COMPONENT LOCATIONS

25 TON CONTROL BOX

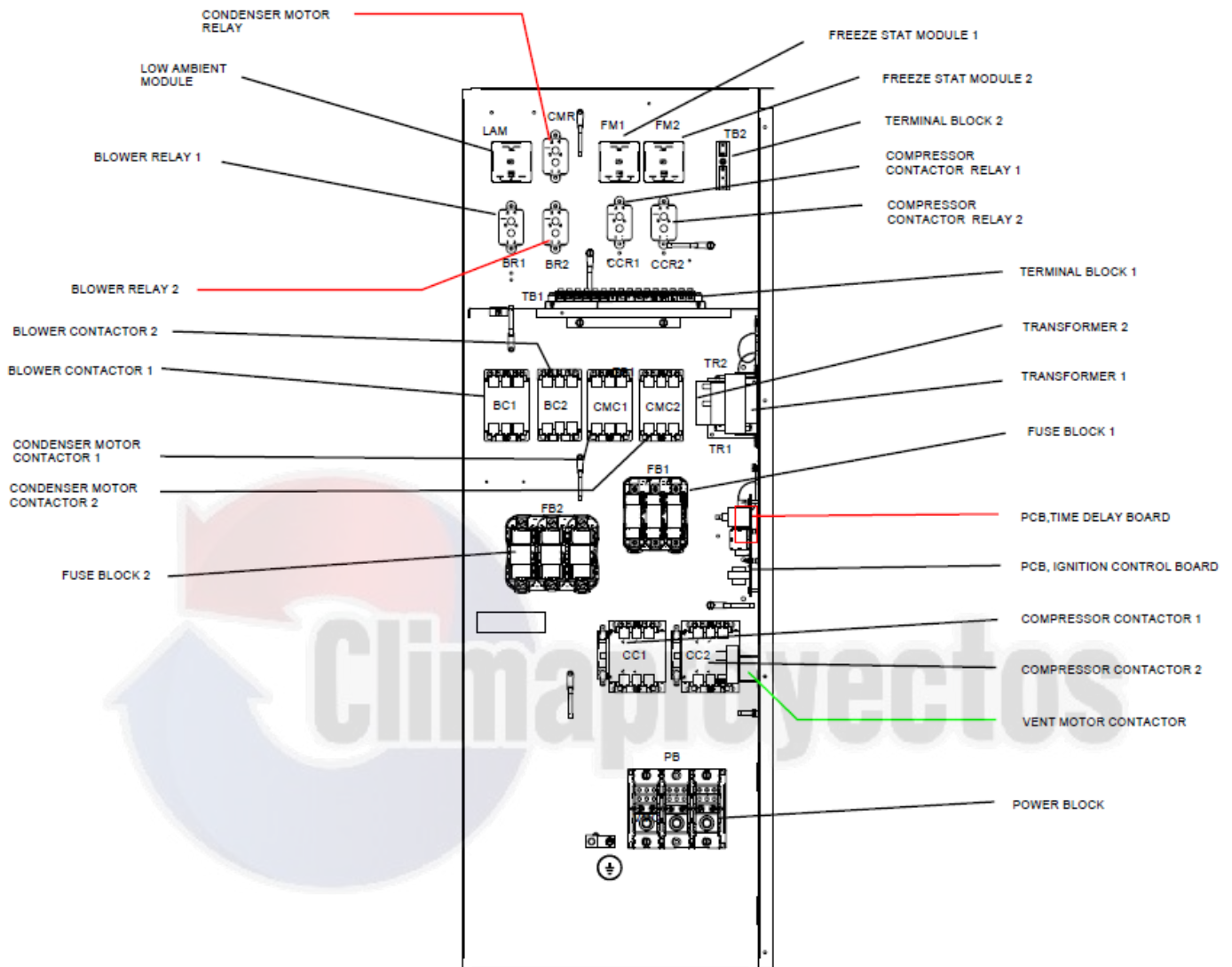

NOTE: All components shown are included with every product.

CONTROL BOX AND COMPONENT LOCATIONS

25 TON CONTROL BOX

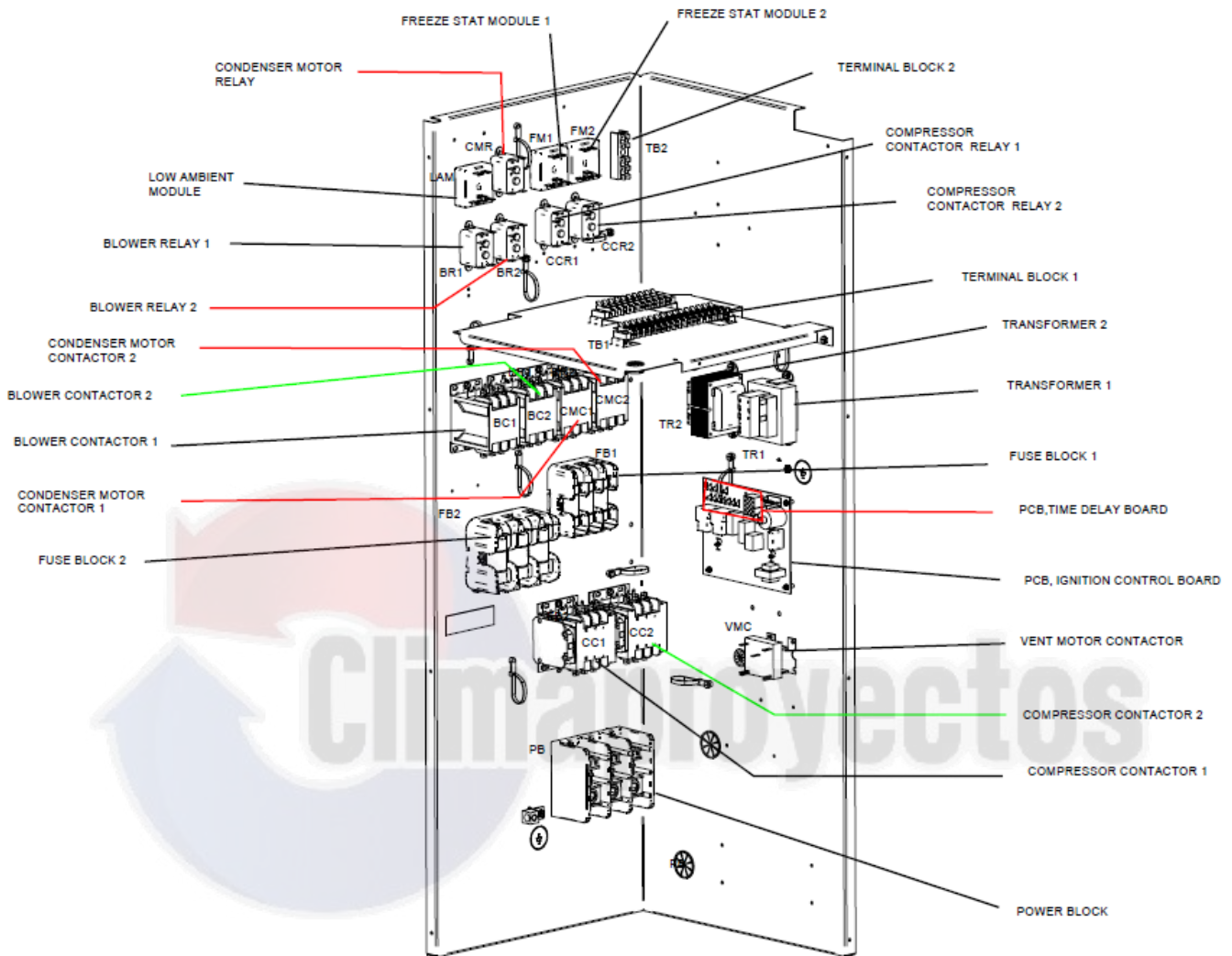

NOTE: All components shown are included with every product.

TROUBLESHOOTING FLOWCHARTS



TROUBLESHOOTING FLOWCHARTS

Voltage Troubleshooting Flowchart

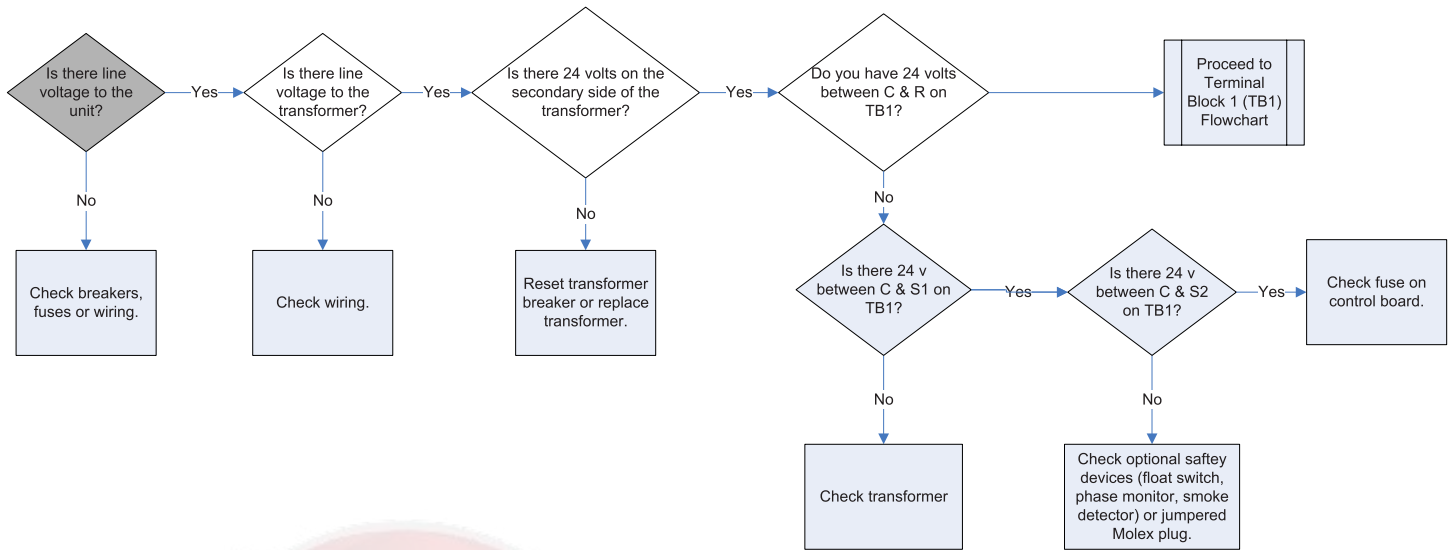

Terminal Block 1 (TB1) Troubleshooting Flowchart

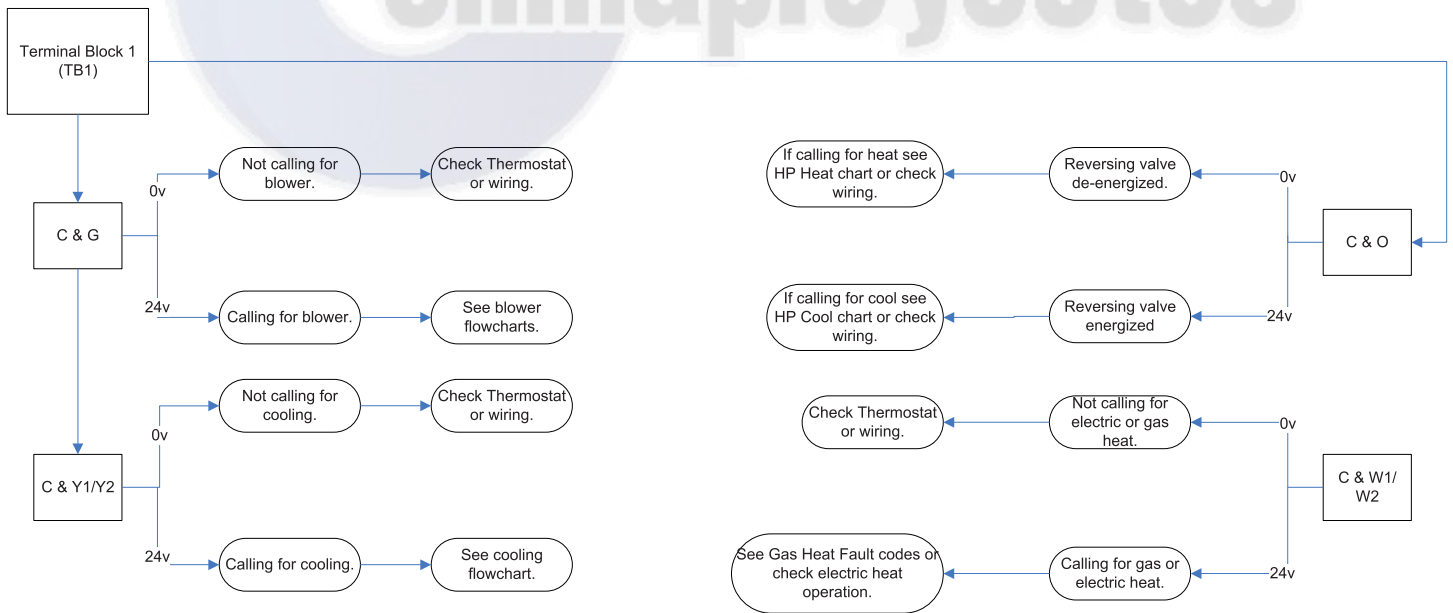

TROUBLESHOOTING FLOWCHARTS

ECM Blower Troubleshooting Flowchart

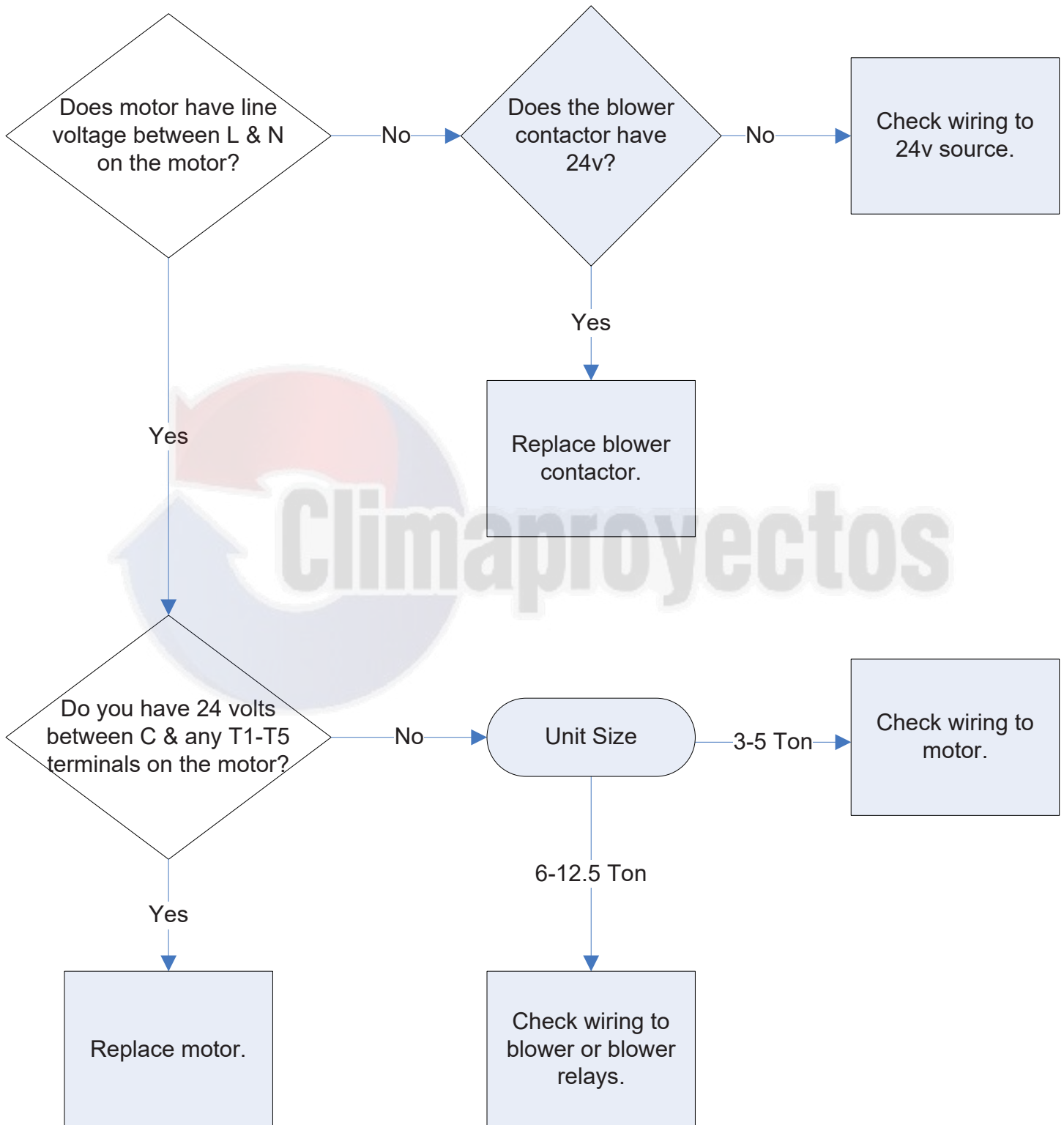

TROUBLESHOOTING FLOWCHARTS

Belt Drive Motor Troubleshooting Flowchart

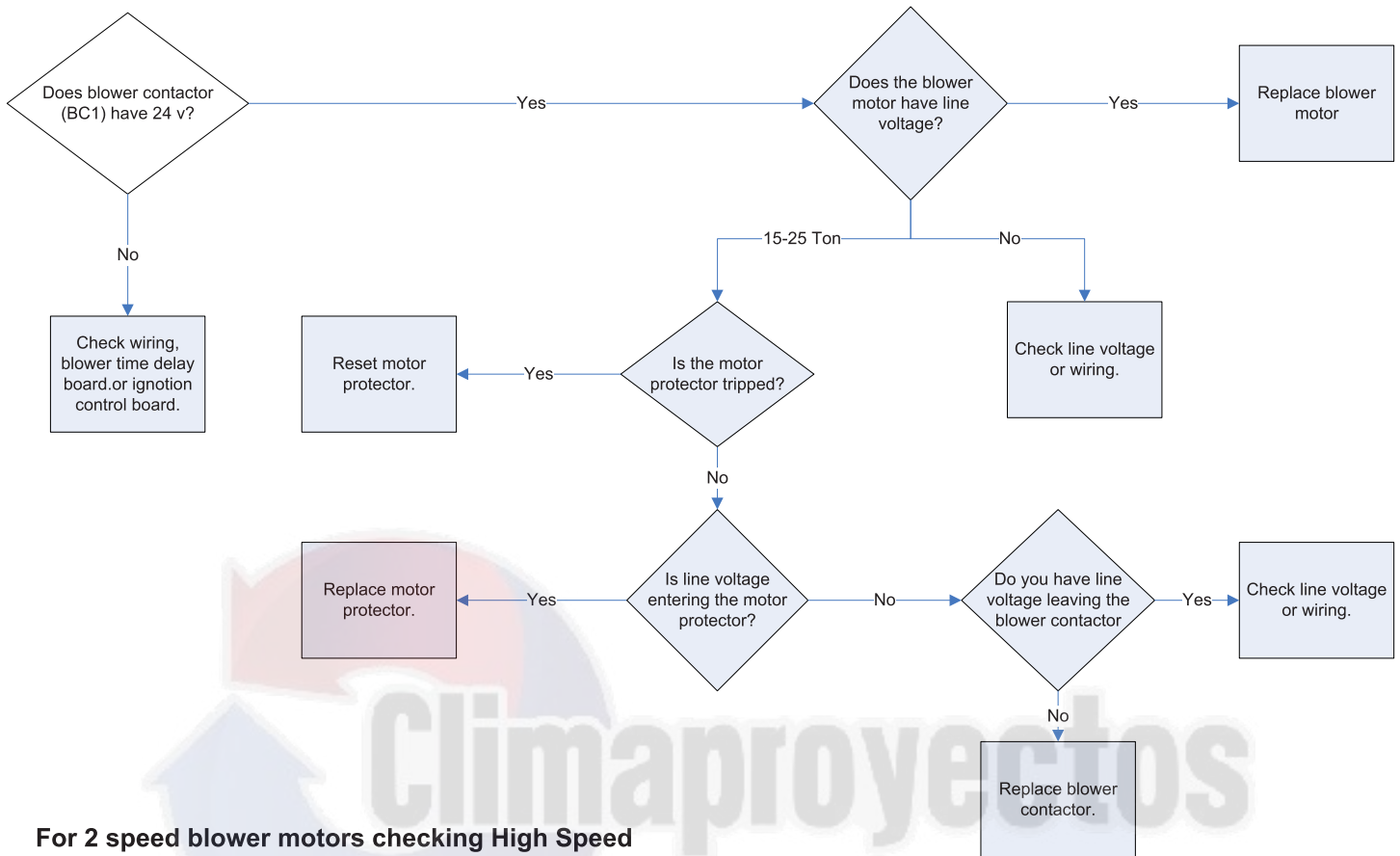

For 2 speed blower motors checking High Speed

1. Follow same procedure starting with blower contactor 2 (BC2) as low speed BC1.
2. Blower contactors BC1 and BC2 should never be energized at the same time. If this occurs, check wiring.
3. On 15-25 ton systems, if the external motor breaker trips on high speed but not low speed, check that the motor speed are wired to the correct high and low speed breakers and verify motor amperage.
4. If the blower spins in different directions when switching between low and high speeds, check the motor phasing of the speed spinning the wrong direction.

TROUBLESHOOTING FLOWCHARTS

Low Stage Gas/Electric Unit Cooling Troubleshooting Flowchart

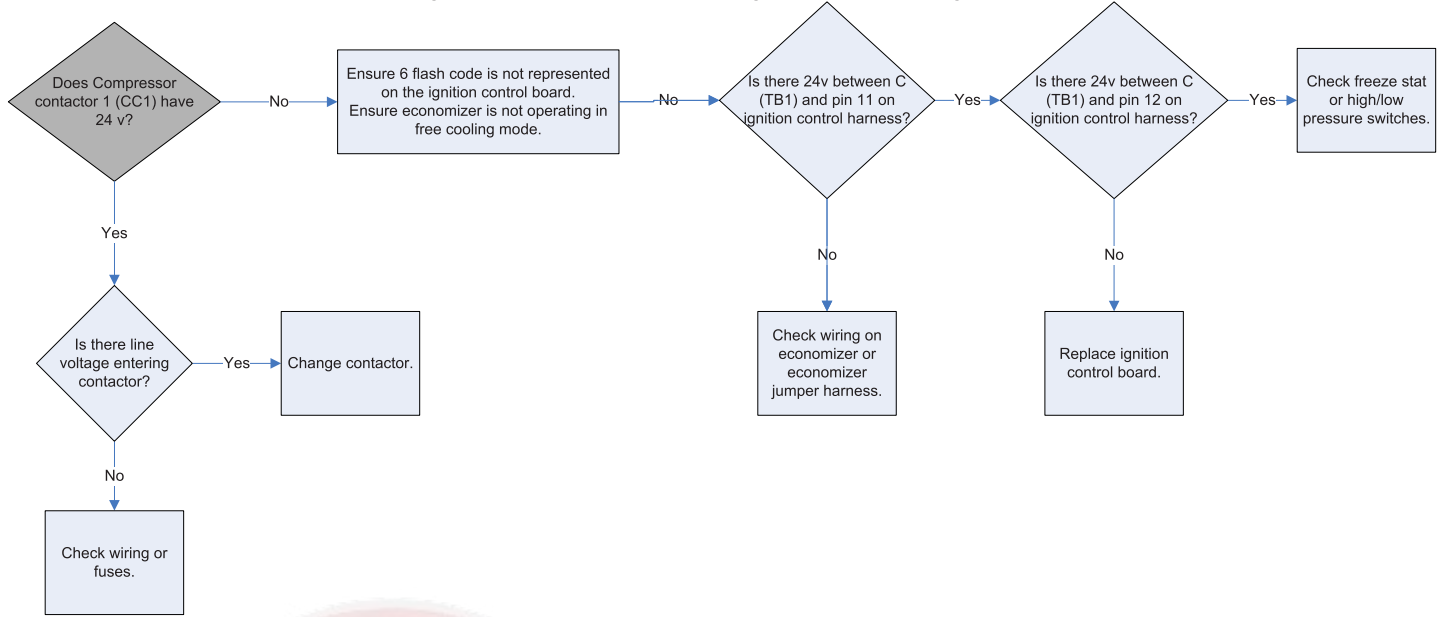

High Stage Gas/Electric Unit Cooling Troubleshooting Flowchart

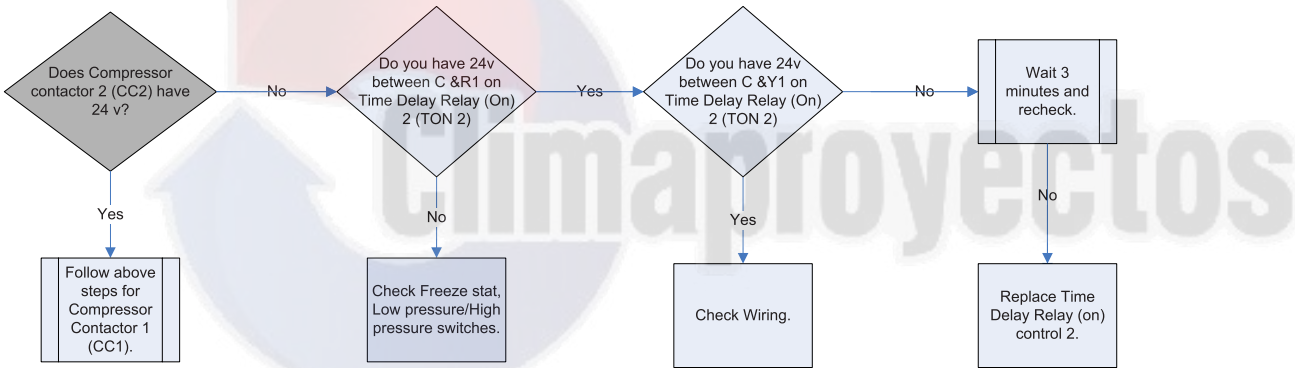

TROUBLESHOOTING FLOWCHARTS

Heat Pump (Not Cooling) Troubleshooting Flowchart

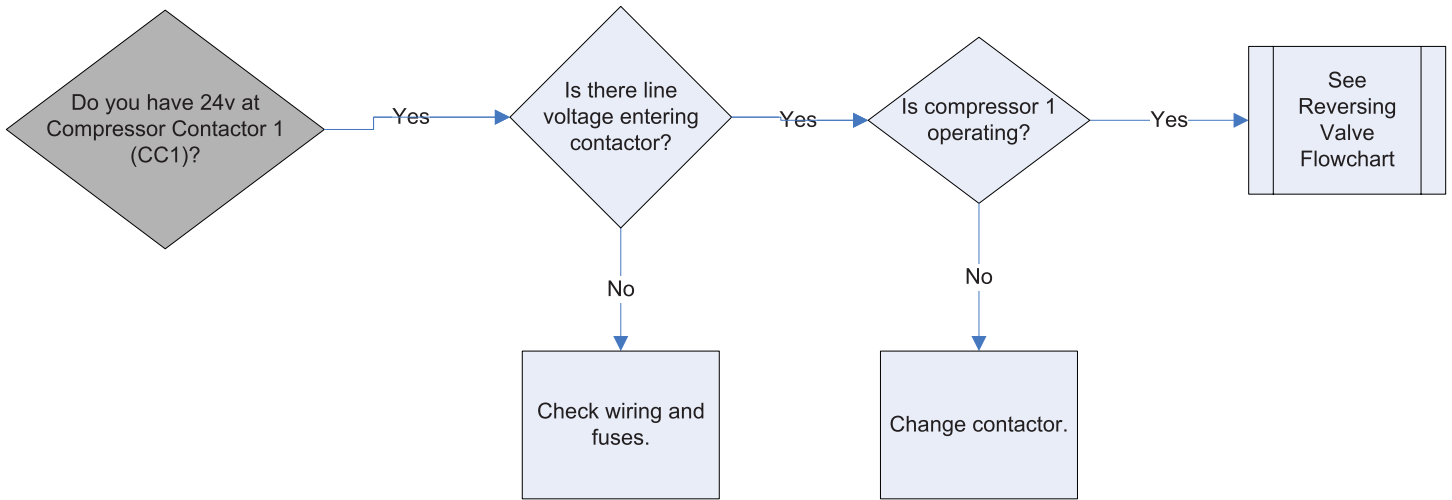

TROUBLESHOOTING FLOWCHARTS

Reversing Valve (When Checking Cooling) Troubleshooting Flowchart

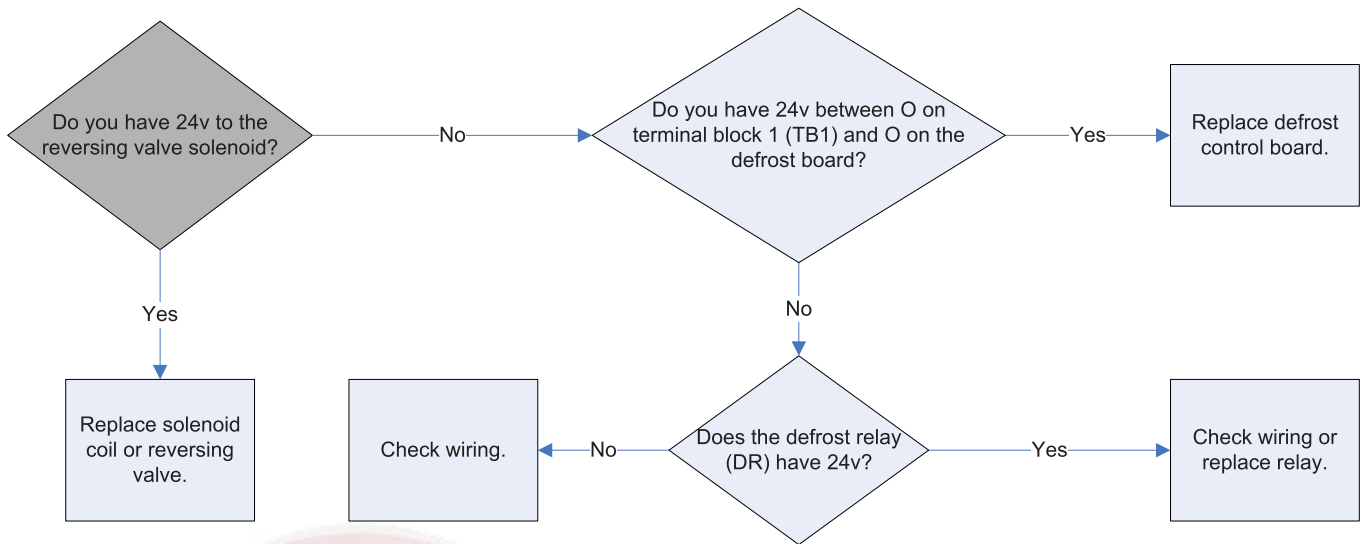

Reversing Valve (When Checking Heating) Troubleshooting Flowchart

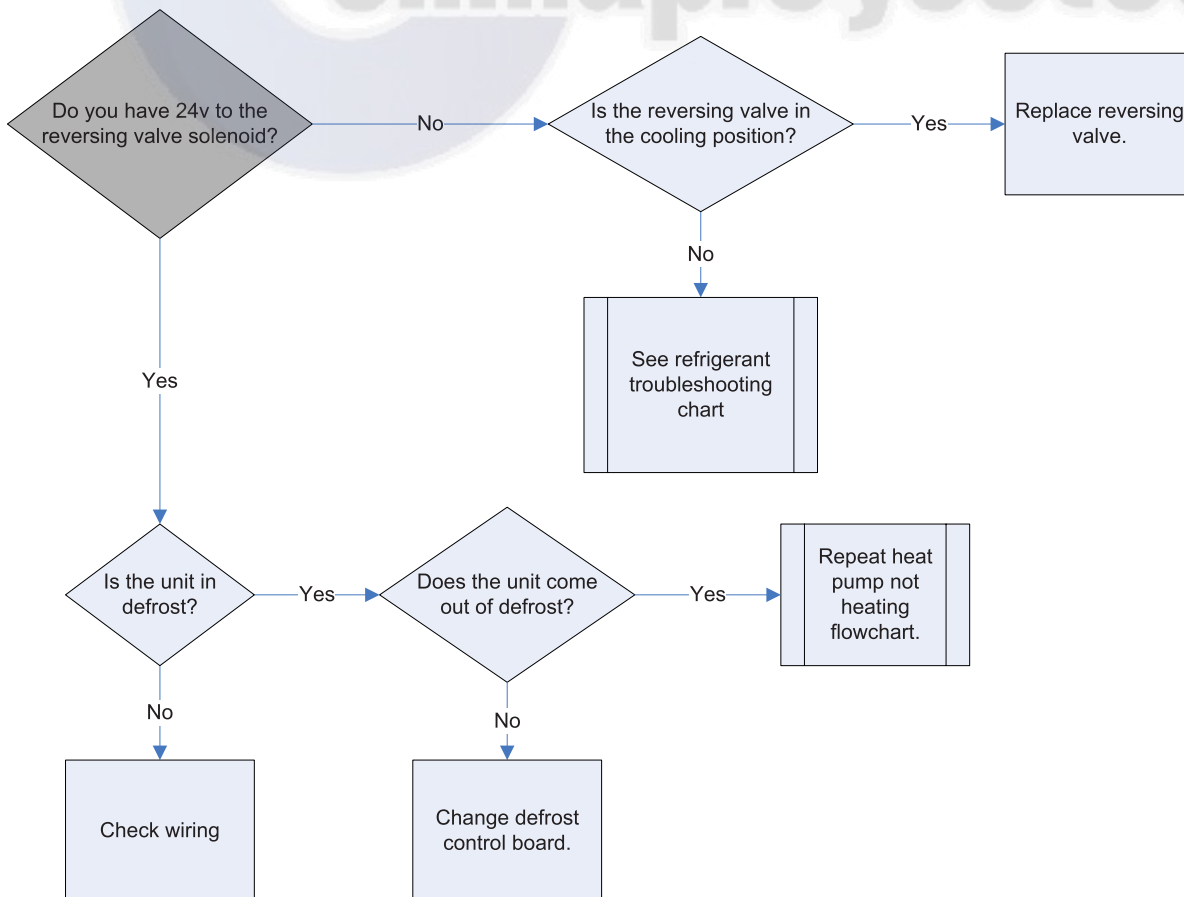

TROUBLESHOOTING FLOWCHARTS

Air Conditioner Unit Troubleshooting Flowchart

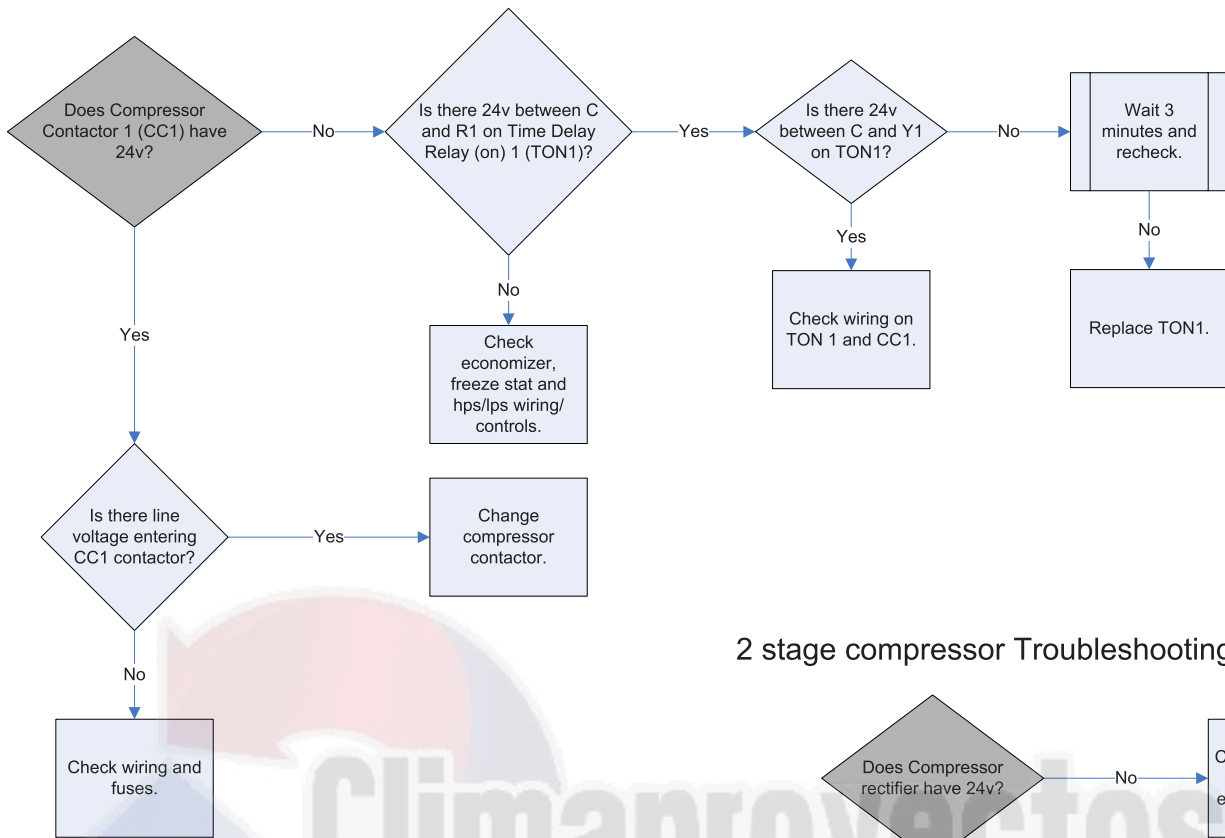

2 stage compressor Troubleshooting Flowchart

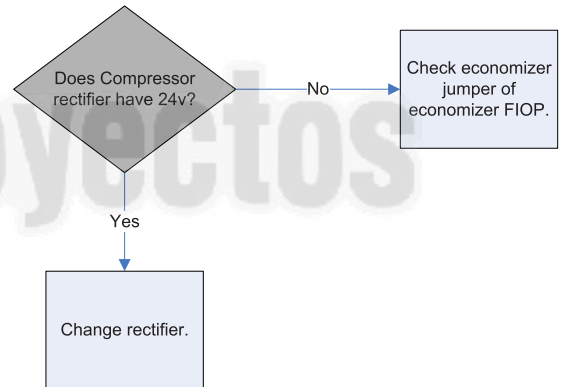

*Use same procedure for checking 2nd stage compressor starting with compressor contactor 2 (CC2).

TROUBLESHOOTING FLOWCHARTS

No Electric Heat Troubleshooting Flowchart

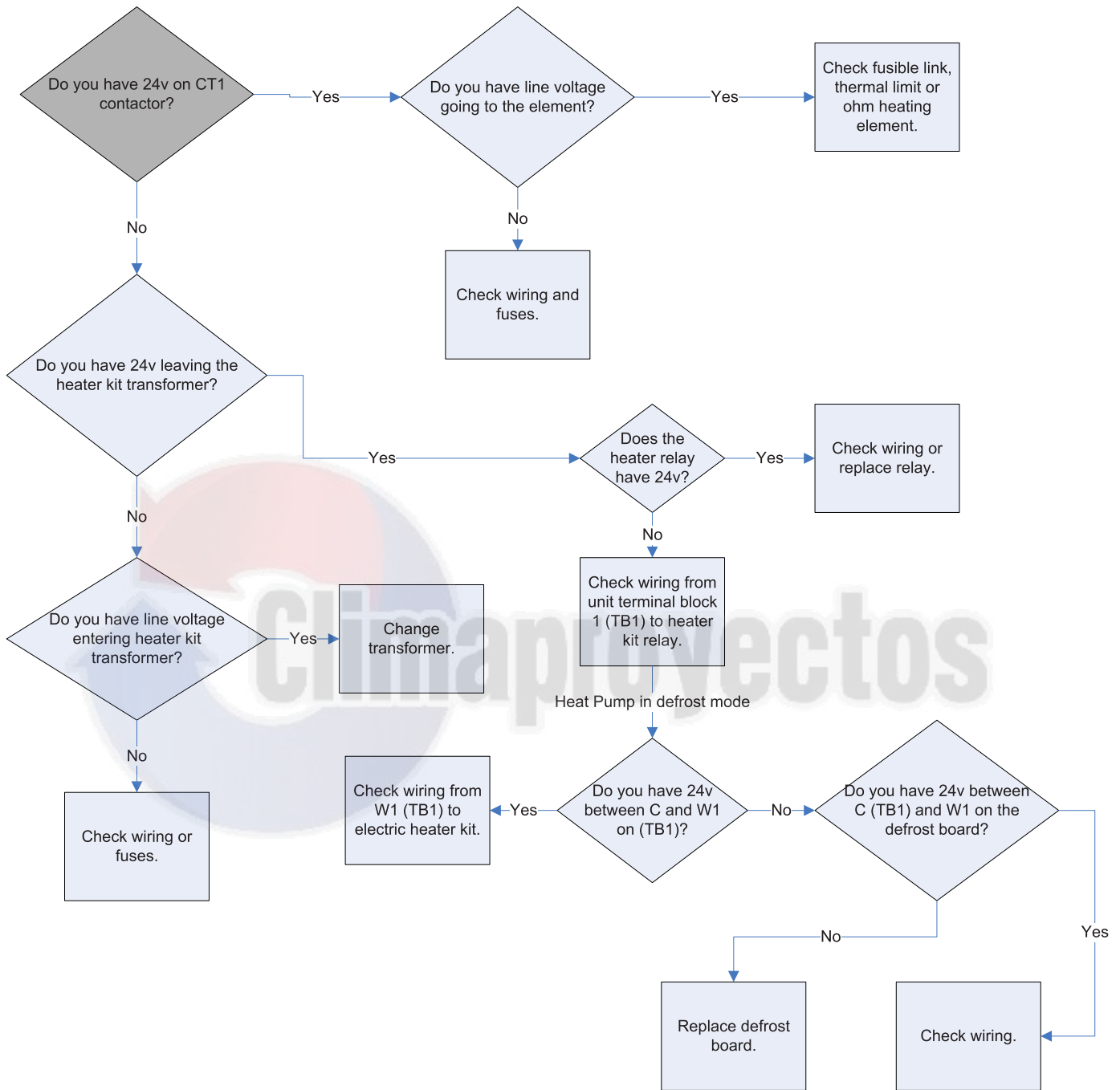

For 2 stage heaters, follow the same procedure for the additional contactors.

SERVICING

ELECTRICAL SERVICING TABLE OF CONTENTS

S-1 CHECKING VOLTAGE.....	28
S-2 CHECKING WIRING.....	29
S-4 CHECKING TRANSFORMER AND CONTROL CIRCUIT.	29
S-8 CHECKING CONTACTOR CONTACTS	29
S-9 CHECKING FAN RELAY CONTACTS	30
S-11 CHECKING LOSS OF CHARGE PROTECTOR	30
S-13 CHECKING LOW PRESSURE CONTROL.....	30
S-15 CHECKING CAPACITOR	31
S-16D CHECKING ECM MOTORS	31
S-17 CHECKING COMPRESSOR WINDINGS.....	31
S-18 TESTING CRANKCASE HEATER	32
S-21 CHECKING REVERSING VALVE AND SOLENOID.....	32
S-24 TESTING DEFROST CONTROL.....	32
S-25 TESTING DEFROST THERMOSTAT	33
S-50 CHECKING HEATER LIMIT CONTROLS	33
S-52 CHECKING HEATER ELEMENTS.....	34
S-201 CHECKING TEMPERATURE RISE	34
S-206 INDOOR FAN ROTATION CHECK	34



SERVICING

S-1 CHECKING VOLTAGE



WARNING

HIGH VOLTAGE!
 Disconnect ALL power before servicing or installing this unit. Multiple power sources may be present. Failure to do so may cause property damage, personal injury or death.



1. Remove doors, control panel cover, etc. from unit being tested.

With power ON:



WARNING

Line Voltage now present.

2. Using a voltmeter, measure the voltage across terminals L1 and L2 of the contactor for single phase units, and L3, for 3 phase units.
3. No reading - indicates open wiring, open fuse(s) no power or etc. from unit to fused disconnect service. Repair as needed.
4. With ample voltage at line voltage connectors, energize the unit.
5. Measure the voltage with the unit starting and operating, and determine the unit Locked Rotor Voltage.

Locked Rotor Voltage is the actual voltage available at the compressor during starting, locked rotor, or a stalled condition. Measured voltage should be above minimum listed in chart below.

To measure Locked Rotor Voltage attach a voltmeter to the run "R" and common "C" terminals of the compressor, or to the T₁ and T₂ terminals of the contactor. Start the unit and allow the compressor to run for several seconds, then shut down the unit. Immediately attempt to restart the unit while measuring the Locked Rotor Voltage.

6. Voltmeter should read within the voltage tabulation as shown. If the voltage falls below the minimum voltage, check the line wire size. Long runs of undersized wire can cause low voltage. If wire size is adequate, notify the local power company in regards to either low or high voltage.

Unit Supply Voltage		
Voltage	Min.	Max.
208/230	198	253
460	437	506
575	546	604

Three phase units require a balanced 3 phase power supply to operate. If the percentage of voltage imbalance exceeds 3% the unit must not be operated until the voltage condition is corrected.

$$\% \text{ Voltage Imbalance} = \frac{\text{Max. Voltage Deviation From Average Voltage}}{\text{Average Voltage}} \times 100$$

To find the percentage of imbalance, measure the incoming power supply.

$$\begin{aligned} L1 - L2 &= 240V \\ L1 - L3 &= 232V \\ L2 - L3 &= 238V \\ \text{Total} &= 710V \end{aligned} \quad \text{Avg. } V = \frac{710}{3} = 236.7$$

To find Max. deviation:

$$\begin{aligned} 240 - 236.7 &= +3.3 \\ 232 - 236.7 &= -4.7 \\ 238 - 236.7 &= +1.3 \end{aligned}$$

Max deviation was 4.7V
 $\% \text{ Voltage Imbalance} = \frac{4.7}{236.7} = 1.99\%$

If the percentage of imbalance had exceeded 3%, it must be determined if the imbalance is in the incoming power supply or the equipment. To do this rotate the legs of the incoming power and retest voltage as shown below.

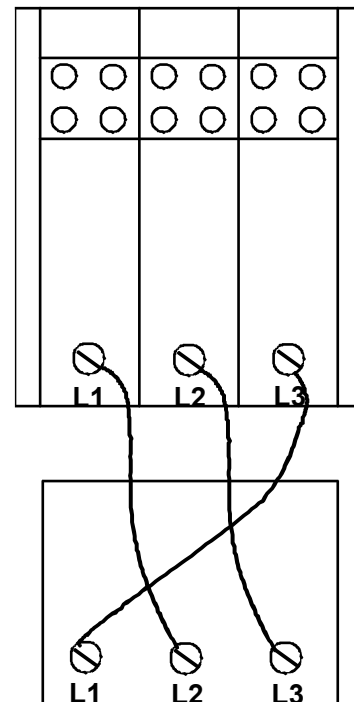

SERVICING

By the voltage readings we see that the imbalance rotated or traveled with the switching of the incoming legs. Therefore the imbalance lies within the incoming power supply.

If the imbalance had not changed then the problem would lie within the equipment. Check for current leakage, shorted motors, etc.

S-2 CHECKING WIRING

 **WARNING**

HIGH VOLTAGE!
Disconnect ALL power before servicing or installing this unit. Multiple power sources may be present. Failure to do so may cause property damage, personal injury or death.



1. Check wiring visually for signs of overheating, damaged insulation and loose connections.
2. Use an ohmmeter to check continuity of any suspected open wires.
3. If any wires must be replaced, replace with comparable gauge and insulation thickness.

S-4 CHECKING TRANSFORMER AND CONTROL CIRCUIT

 **WARNING**

HIGH VOLTAGE!
Disconnect ALL power before servicing or installing this unit. Multiple power sources may be present. Failure to do so may cause property damage, personal injury or death.



A step-down transformer (either 208-240, 460 or 575 volt primary to 24 volt secondary) is provided with each unit. This allows ample capacity for use with resistance heaters.

 **WARNING**

Disconnect ALL power before servicing.

1. Remove control panel cover to gain access to transformer.

With power ON:

 **WARNING**

Line Voltage now present.

2. Using a voltmeter, check voltage across secondary voltage side of transformer (R to C).
3. No voltage indicates faulty transformer, bad wiring, or bad splices.
4. Check transformer primary voltage at incoming line voltage connections and/or splices.
5. If line voltage available at primary voltage side of transformer and wiring and splices good, transformer is inoperative. Replace.

S-8 CHECKING CONTACTOR CONTACTS

 **WARNING**

HIGH VOLTAGE!
Disconnect ALL power before servicing or installing this unit. Multiple power sources may be present. Failure to do so may cause property damage, personal injury or death.



1. Disconnect the wire leads from the terminal (T) side of the contactor.
2. With power ON, energize the contactor.

 **WARNING**

Line Voltage now present.

3. Using a voltmeter, test across terminals.
 - A. L1-L2, L1-L3, and L2-L3 - If voltage is present, proceed to B. If voltage is not present, check breaker or fuses on main power supply.
 - B. T1-T2, T1-T3, and T2-T3 - If voltage readings are not the same as in "A", replace contactor.

SERVICING

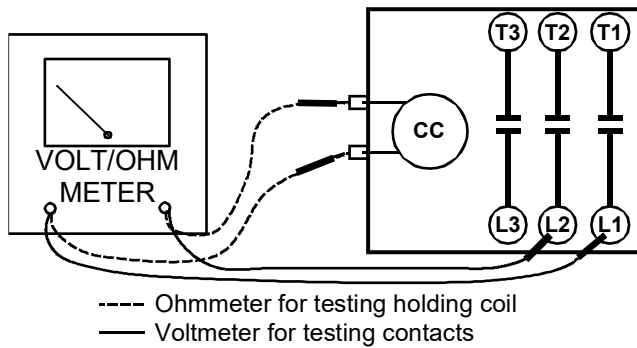

TESTING COMPRESSOR CONTACTOR
(THREE PHASE)

S-9 CHECKING FAN RELAY CONTACTS

FAN CONTROLS

DBG: The fan control is incorporated into the control board. See Ignition Control Board (PCBAG123) section for checking control board for gas models.

For 3 phase and belt drive models, the procedure for testing the fan relay contacts will be the same as checking the compressor contactor contacts

DBC/DBH: The Electronic Blower Time Delay Relay (PCBFM103) is used on belt driven models.

WARNING

HIGH VOLTAGE!
Disconnect ALL power before servicing or installing this unit. Multiple power sources may be present. Failure to do so may cause property damage, personal injury or death.



Checking EBTDR Contact Operation

1. With power off, remove wires from terminals NC, COM, and NO.
2. Using a VOM, check for resistance from NO to COM. Should read open. Next, check for resistance from NC to COM. Should read closed.
3. If not as above, replace EBTDR.

CHECKING EBTDR CONTACT OPERATION

With power on:

1. Set the thermostat to the fan “on” position.
2. Check for 24 volts at the C and G terminals of the EBTDR.
3. If no voltage present, check fan circuit from thermostat. If 24 volts present, proceed to step 4.

4. Using a VOM, check for line voltage from the purple wire at the transformer (terminal 3 on 240 volt units, terminal 2 on 208 volt units) to terminal NO on the EBTDR. Should read line voltage. If no voltage present, check line voltage wiring in unit. If line voltage present, proceed to step 5.
5. Using a VOM, check for line voltage from the purple wire at the transformer (terminal 3 on 240 volt units, terminal 2 on 208 volt units) to the COM terminal on the EBTDR. Should read line voltage. If not as above, replace EBTDR.

On the 5 ton units with the ECM motor, a standard fan relay is used.

1. Apply 24 volts to coil terminals 1 and 3.
2. Using a VOM, check for 24 volts from terminals 3 and 2 of relay. Should read 24 volts. If no voltage, check low voltage wiring from transformer to relay. If voltage present, proceed to step 5.
3. Using a VOM, check for 24 volts from terminals 3 and 4 of relay. Should read 24 volts. If not as above, replace relay.

S-11 CHECKING LOSS OF CHARGE PROTECTOR (HEAT PUMP MODELS)

The loss of charge protector senses the pressure in the liquid line and will open its contacts on a drop in pressure. The low pressure control will automatically reset itself with a rise in pressure.

The low pressure control is designed to cut-out (open) at approximately 22 PSIG. It will automatically cut-in (close) at approximately 50 PSIG.

Test for continuity using a VOM and if not as above, replace the control.

S-13 CHECKING LOW PRESSURE CONTROL

The low pressure control senses the pressure in the suction line and will open its contacts on a drop in pressure. The low pressure control will automatically reset itself with a rise in pressure.

The low pressure control is designed to cut-out (open) at approximately 22 PSIG \pm 7 PSIG. It will automatically cut-in (close) at approximately 50 PSIG \pm 7 PSIG.

Test for continuity using a VOM and if not as above, replace the control.

NOTE: Screw on style pressure switches have schrader cores installed so the switch can be replaced without loss of charge.

SERVICING

S-15 CHECKING CAPACITOR CAPACITOR, RUN

A run capacitor is wired across the auxiliary and main windings of a single phase permanent split capacitor motor. The capacitor primary function is to reduce the line current while greatly improving the torque characteristics of a motor. This is accomplished by using the 90° phase relationship between the capacitor current and voltage in conjunction with the motor windings so that the motor will give two phase operation when connected to a single phase circuit. The capacitor also reduces the line current to the motor by improving the power factor.

CAPACITOR, START SCROLL COMPRESSOR MODELS

Hard start components are not required on Scroll compressor equipped units due to a non-replaceable check valve located in the discharge line of the compressor. However hard start kits are available and may improve low voltage starting characteristics.

This check valve closes off high side pressure to the compressor after shut down allowing equalization through the scroll flanks. Equalization requires only about one or two seconds during which time the compressor may turn backwards.

Your unit comes with a 180-second anti-short cycle to prevent the compressor from starting and running backwards.

S-16D CHECKING ECM (ENERGY EFFICIENT MOTOR) MOTORS

APPLIES ONLY TO UNITS WITH ECM MOTORS

The ECM Motor is a one piece, fully encapsulated, 3 phase brushless DC (single phase AC input) motor with ball bearing construction. Unlike the ECM 2.3/2.5 motors, the ECM features an integral control module.

NOTE: The GE TECMate will not currently operate the GE ECM motor.

1. Using a voltmeter, check for 230 volts to the motor connections L and N. If 230 volts is present, proceed to step 2. If 230 volts is not present, check the line voltage circuit to the motor.
2. Using a voltmeter, check for 24 volts from terminal C to either terminal 1, 2, 3, 4, or 5, depending on which tap is being used, at the motor. If voltage present, proceed to step 3. If no voltage, check 24 volt circuit to motor.

3. If voltage was present in steps 1 and 2, the motor has failed and will need to be replaced.

NOTE: When replacing motor, ensure the belly band is between the vents on the motor and the wiring has the proper drip loop to prevent condensate from entering the motor.

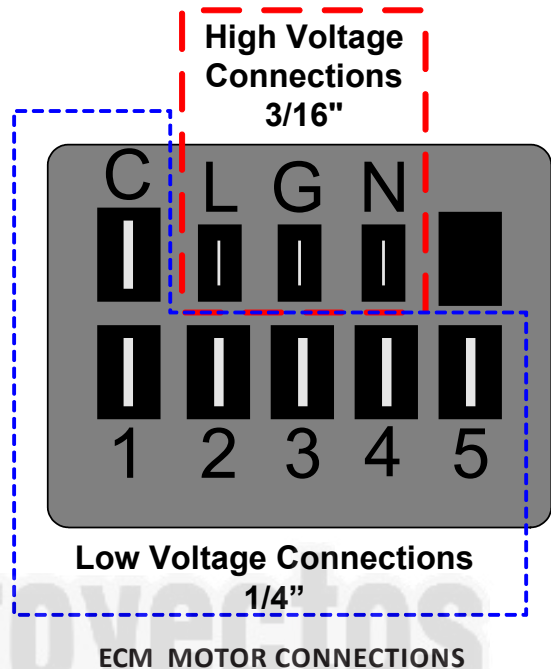

S-17 CHECKING COMPRESSOR WINDINGS



WARNING

Hermetic compressor electrical terminal venting can be dangerous. When insulating material which supports a hermetic compressor or electrical terminal suddenly disintegrates due to physical abuse or as a result of an electrical short between the terminal and the compressor housing, the terminal may be expelled, venting the vapor and liquid contents of the compressor housing and system.

If the compressor terminal PROTECTIVE COVER and gasket (if required) are not properly in place and secured, there is a remote possibility if a terminal vents, that the vaporous and liquid discharge can be ignited, spouting flames several feet, causing potentially severe or fatal injury to anyone in its path.

This discharge can be ignited external to the compressor if the terminal cover is not properly in place and if the discharge impinges on a sufficient heat source.

SERVICING

Ignition of the discharge can also occur at the venting terminal or inside the compressor, if there is sufficient contaminant air present in the system and an electrical arc occurs as the terminal vents.

Ignition cannot occur at the venting terminal without the presence of contaminant air, and cannot occur externally from the venting terminal without the presence of an external ignition source.

Therefore, proper evacuation of a hermetic system is essential at the time of manufacture and during servicing.

To reduce the possibility of external ignition, all open flame, electrical power, and other heat sources should be extinguished or turned off prior to servicing a system.

S-18 TESTING CRANKCASE HEATER (OPTIONAL ITEM)

The crankcase heater must be energized a minimum of four (4) hours before the condensing unit is operated.

Crankcase heaters are used to prevent migration or accumulation of refrigerant in the compressor crankcase during the off cycles and prevents liquid slugging or oil pumping on start up.

A crankcase heater will not prevent compressor damage due to a floodback or over charge condition.



WARNING

Disconnect ALL power before servicing.

1. Disconnect the heater lead in wires.
2. Using an ohmmeter, check heater continuity - should test continuous. If not, replace.

The condition of the scroll flanks is checked in the following manner.

1. Attach gauges to the high and low side of the system.
2. Start the system and run a "Cooling Performance Test."

If the test shows:

- A. Below normal high side pressure.
- B. Above normal low side pressure.
- C. Low temperature difference across coil.
- D. Low amp draw at compressor.

And the charge is correct. The compressor is faulty - replace the compressor.

S-21 CHECKING REVERSING VALVE AND SOLENOID

Occasionally the reversing valve may stick in the heating or cooling position or in the mid-position.

When stuck in the mid-position, part of the discharge gas from the compressor is directed back to the suction side, resulting in excessively high suction pressure. An increase in the suction line temperature through the reversing valve can also be measured. Check operation of the valve by starting the system and switching the operation from COOLING to HEATING cycle.

If the valve fails to change its position, test the voltage (24V) at the valve coil terminals, while the system is on the COOLING cycle.

If no voltage is registered at the coil terminals, check the operation of the thermostat and the continuity of the connecting wiring from the "O" terminal of the thermostat to the unit.

If voltage is registered at the coil, tap the valve body lightly while switching the system from HEATING to COOLING, etc. If this fails to cause the valve to switch positions, remove the coil connector cap and test the continuity of the reversing valve solenoid coil. If the coil does not test continuous - replace it.

If the coil test continuous and 24 volts is present at the coil terminals, the valve is inoperative - replace it.

S-24 TESTING DEFROST CONTROL

To check the defrost control for proper sequencing, proceed as follows: With power ON; unit not running.

1. Jumper defrost thermostat by placing a jumper wire across the terminals "DFT" and "R" at defrost control board.
2. Connect jumper across test pins on defrost control board.
3. Set thermostat to call for heating. System should go into defrost within 21 seconds.
4. Immediately remove jumper from test pins.
5. Using VOM check for voltage across terminals "C & O". Meter should read 24 volts.
6. Using VOM check for voltage across fan terminals DF1 and DF2 on the board. You should read line voltage (208-230 VAC) indicating the relay is open in the defrost mode.
7. Using VOM check for voltage across "W2 & C" terminals on the board. You should read 24 volts.
8. If not as above, replace control board.

SERVICING

9. Set thermostat to off position and disconnect power before removing any jumpers or wires.

NOTE: Remove jumper across defrost thermostat before returning system to service.

S-25 TESTING DEFROST THERMOSTAT

1. Install a thermocouple type temperature test lead on the tube adjacent to the defrost control. Insulate the lead point of contact.
2. Check the temperature at which the control closes its contacts by lowering the temperature of the control. On 2 and 2.5 ton units, it should close at $34^{\circ}\text{F} \pm 5^{\circ}\text{F}$. On 3 thru 5 ton units, it should close at $31^{\circ}\text{F} \pm 3^{\circ}\text{F}$.
3. Check the temperature at which the control opens its contacts by raising the temperature of the control. On 2 and 2.5 ton units, it should open at $60^{\circ}\text{F} \pm 5^{\circ}\text{F}$. On 3 thru 5 ton units, it should open at $75^{\circ}\text{F} \pm 6^{\circ}\text{F}$.
4. If not as above, replace control.

TROUBLESHOOTING

THE FOLLOWING INFORMATION IS FOR USE BY QUALIFIED SERVICE AGENCY ONLY: OTHERS SHOULD NOT ATTEMPT TO SERVICE THIS EQUIPMENT.

COMMON CAUSES OF UNSATISFACTORY OPERATION OF HEAT PUMP ON THE HEATING CYCLE.

INADEQUATE AIR VOLUME THROUGH INDOOR COIL

When a heat pump is in the heating cycle, the indoor coil is functioning as a condenser. The return air filter must always be clean, and sufficient air volume must pass through the indoor coil to prevent excessive discharge pressure, and high pressure cut out.

OUTSIDE AIR INTO RETURN DUCT

Do not introduce cold outside air into the return duct of a heat pump installation. For units with 2-speed motors, do not allow air entering the indoor coil to drop below 65°F . Air below this temperature will cause low discharge pressure, thus low suction pressure, and excessive defrost cycling resulting in low heating output. It may also cause false defrosting.

UNDERCHARGE

An undercharged heat pump on the heating cycle will cause low discharge pressure resulting in low suction pressure and frost accumulation on the outdoor coil.

POOR "TERMINATING" SENSOR CONTACT

The unit's defrost terminating sensor must make good thermal contact with the outdoor coil tubing. Poor contact may not terminate the unit's defrost cycle quickly enough to prevent the unit from cutting out on high discharge pressure.

MALFUNCTIONING REVERSING VALVE - THIS MAY BE DUE TO:

1. **Solenoid not energized** - In order to determine if the solenoid is energized, touch the nut that holds the solenoid cover in place with a screwdriver. If the nut magnetically holds the screwdriver, the solenoid is energized and the unit is in the cooling cycle.
2. **No voltage at unit's solenoid** - Check unit voltage. If no voltage, check wiring circuit.
3. **Valve will not shift:**
 - A. **Undercharged** - check for leaks;
 - B. **Valve Body Damaged** - Replace valve;
 - C. **Unit Properly Charged** - If it is on the heating cycle, raise the discharge pressure by restricting airflow through the indoor coil. If the valve does not shift, tap it **lightly** on both ends with a screwdriver handle. **DO NOT TAP THE VALVE BODY.** If the unit is on the cooling cycle, raise the discharge pressure by restricting airflow through the outdoor coil. If the valve does not shift after the above attempts, cut the unit off and wait until the discharge and suction pressure equalize, and repeat above steps. If the valve does not shift, replace it.

S-50 CHECKING HEATER LIMIT CONTROL(S) **(OPTIONAL ELECTRIC HEATERS)**

Each individual heater element is protected with an automatic rest limit control connected in series with each element to prevent overheating of components in case of low airflow. This limit control will open its circuit at approximately 150°F . to 160°F and close at approximately 110°F .



WARNING

Disconnect ALL power before servicing.



1. Remove the wiring from the control terminals.
2. Using an ohmmeter test for continuity across the normally closed contacts. No reading indicates the control is open - replace if necessary. Make sure the limits are cool before testing.

IF FOUND OPEN - REPLACE - DO NOT WIRE AROUND.

SERVICING

S-52 CHECKING HEATER ELEMENTS

Optional electric heaters may be added, in the quantities shown in the spec sheet for each model unit, to provide electric resistance heating. Under no condition shall more heaters than the quantity shown be installed.

**WARNING**
HIGH VOLTAGE!
Disconnect ALL power before servicing or installing this unit. Multiple power sources may be present. Failure to do so may cause property damage, personal injury or death.

1. Disassemble and remove the heating element(s).
2. Visually inspect the heater assembly for any breaks in the wire or broken insulators.
3. Using an ohmmeter, test the element for continuity - no reading indicates the element is open. Replace as necessary.

S-201 CHECKING TEMPERATURE RISE

Temperature rise is related to the BTUH output of the unit and the amount of air (CFM) circulated over the heat exchanger.

All units are designed for a given range of temperature increase. This is the temperature of the air leaving the unit minus the temperature of the air entering the unit.

The more air (CFM) being delivered through a given unit the less the rise will be; so the less air (CFM) being delivered, the greater the rise. The temperature rise should be adjusted in accordance to a given unit specifications and its external static pressure.

1. Check BTUH input to unit do not exceed input rating stamped on rating plate.
2. Take entering and leaving air temperatures.
3. Select the proper speed tap or dip switch setting for direct drive units.
4. For gas heat units, the airflow must be adjusted so that the air temperature rise falls within the ranges given stated on Data Plate by adjusting the variable pitch sheave on the motor (see Blower Performance section in appropriate Specifications Sheet Manual for correct pulley adjustment).
5. Take motor amperage draw to determine that the motor is not overloaded during adjustments.

S-206 INDOOR FAN ROTATION CHECK

EVAPORATOR FAN ROTATION CHECK (THREE PHASE MODELS ONLY)

Check that fan rotates clockwise when viewed from the drive side of unit and in accordance with rotation arrow shown on blower housing. If it does not, reverse any two incoming power cables at Single Point Power Block. In this case, repeat bearing check.

Do not attempt to change load side wiring. Internal wiring assures all motors and compressors will rotate in correct direction once evaporator fan motor rotation check has been made.

SERVICING

Air Conditioning Diagnostic Chart					
Issue	Discharge Pressure	Suction Pressure	(Orifice) Superheat	(TXV) Subcooling	Temperature Split
Liquid Line Restriction	↓	↓	↑	↑	↓
System Undercharge	↓	↓	↑	↓	↓
System Overcharge	↑	↑	↓	↑	↓
Non Condensibles	↑	↑	↑	↑	↓
Low Indoor Airflow	↓	↓	↓	↑	↑
Inefficient Compressor	↓	↑	↑	↓	↓

Heat Pump Diagnostic Chart					
Issue	Discharge Pressure	Suction Pressure	(Orifice) Superheat	(TXV) Subcooling	Temperature Split
Liquid Line Restriction	↑	↓	↑	↑	↓
System Undercharge	↓	↓	↑	↓	↓
Leaking Reversing Valve	↓	↑	Normal	↓	↓
Low Indoor Airflow	↑	↑	Normal	Normal	↑
Inefficient Compressor	↓	↑	Normal	↓	↓

NOTE: Superheat and Subcooling is determined by the system metering device.

SERVICING

REFRIGERANT SERVICING TABLE OF CONTENTS

S-100 REFRIGERATION REPAIR PRACTICE.....	37
S-101 LEAK TESTING (NITROGEN OR NITROGEN-TRACED)	37
S-102 EVACUATION	37
S-103 CHARGING.....	38
S-104 CHECKING COMPRESSOR EFFICIENCY.....	39
S-106 OVERFEEDING.....	39
S-108 CHECKING SUPERHEAT	39
S-109 CHECKING SUBCOOLING.....	40
S-110 CHECKING EXPANSION VALVE OPERATION	40
S-112 CHECKING RESTRICTED LIQUID LINE	40
S-113A OVERCHARGE OF REFRIGERANT.....	41
S-113B UNDERCHARGE OF REFRIGERANT.....	41
S-114 NON-CONDENSABLES	41
S-115 COMPRESSOR BURNOUT.....	44
S-200 CHECKING EXTERNAL STATIC PRESSURE	44
S-205 CHECKING BELT TENSION	45
S-207 MOTOR SHEAVE ADJUSTMENTS	45

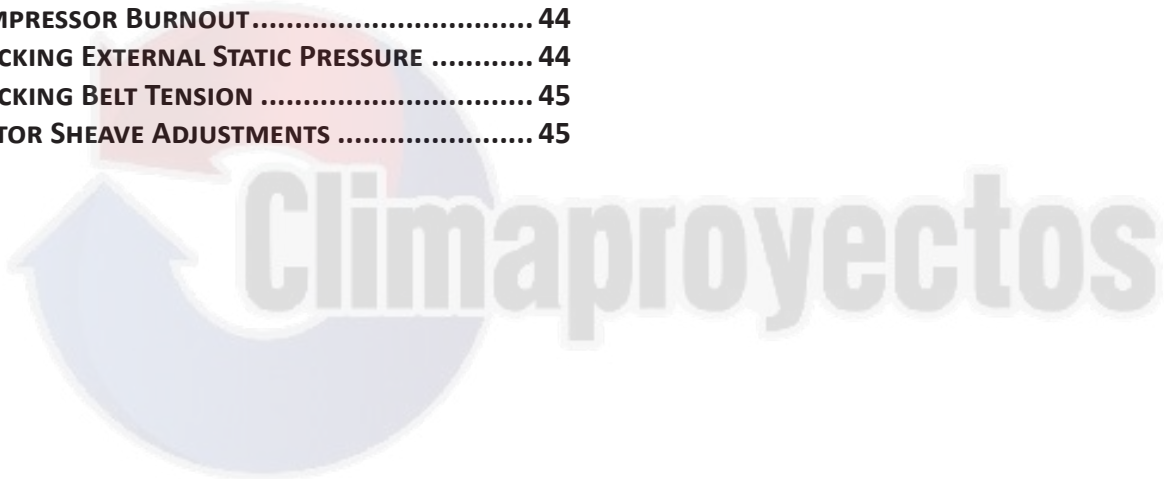

SERVICING

S-100 REFRIGERATION REPAIR PRACTICE



DANGER

Always remove the refrigerant charge in a proper manner before applying heat to the system.

When repairing the refrigeration system:



WARNING

Disconnect ALL power before servicing.

1. Never open a system that is under vacuum. Air and moisture will be drawn in.
2. Plug or cap all openings.
3. Remove all burrs and clean the brazing surfaces of the tubing with sand cloth or paper. Brazing materials do not flow well on oxidized or oily surfaces.
4. Clean the inside of all new tubing to remove oils and pipe chips.
5. When brazing, sweep the tubing with dry nitrogen to prevent the formation of oxides on the inside surfaces.
6. Complete any repair by replacing the liquid line drier in the system, evacuate and charge.

BRAZING MATERIALS

Copper to Copper Joints - Sil-Fos used without flux (alloy of 15% silver, 80% copper, and 5% phosphorous). Recommended heat 1400°F.

Copper to Steel Joints - Silver Solder used without a flux (alloy of 30% silver, 38% copper, 32% zinc). Recommended heat - 1200°F.

S-101 LEAK TESTING (NITROGEN OR NITROGEN-TRACED)



WARNING

To avoid the risk of fire or explosion, never use oxygen, high pressure air or flammable gases for leak testing of a refrigeration system.



WARNING

To avoid possible explosion, the line from the nitrogen cylinder must include a pressure regulator and a pressure relief valve. The pressure relief valve must be set to open at no more than 150 psig.

Pressure test the system using dry nitrogen and soapy water to locate leaks. If you wish to use a leak detector, charge the system to 10 psi using the appropriate refrigerant then use nitrogen to finish charging the system to working pressure, then apply the detector to suspect areas. If leaks are found, repair them. After repair, repeat the pressure test. If no leaks exist, proceed to system evacuation.

S-102 EVACUATION



WARNING

**REFRIGERANT UNDER PRESSURE!
Failure to follow proper procedures may cause property damage, personal injury or death.**

This is the most important part of the entire service procedure. The life and efficiency of the equipment is dependent upon the thoroughness exercised by the serviceman when evacuating air (non-condensables) and moisture from the system.

Air in a system causes high condensing temperature and pressure, resulting in increased power input and reduced performance.

Moisture chemically reacts with the refrigerant oil to form corrosive acids. These acids attack motor windings and parts, causing breakdown.

The equipment required to thoroughly evacuate the system is a high vacuum pump, capable of producing a vacuum equivalent to 25 microns absolute and a thermocouple vacuum gauge to give a true reading of the vacuum in the system

NOTE: Never use the system compressor as a vacuum pump or run when under a high vacuum. Motor damage could occur.



WARNING

Do not front seat the service valve(s) with the compressor open, with the suction line of the compressor closed or severely restricted.

1. Connect the vacuum pump, vacuum tight manifold set with high vacuum hoses, thermocouple vacuum gauge and charging cylinder as shown.

SERVICING

2. Start the vacuum pump and open the shut off valve to the high vacuum gauge manifold only. After the compound gauge (low side) has dropped to approximately 29 inches of vacuum, open the valve to the vacuum thermocouple gauge. See that the vacuum pump will blank-off to a maximum of 25 microns. A high vacuum pump can only produce a good vacuum if its oil is non-contaminated.

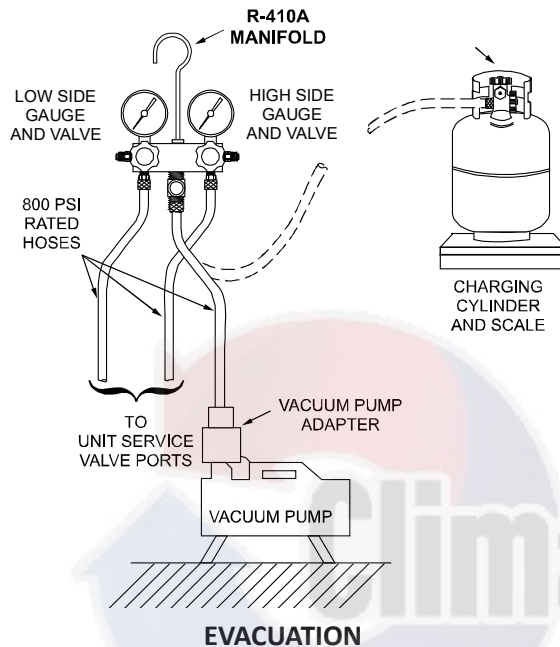

3. If the vacuum pump is working properly, close the valve to the vacuum thermocouple gauge and open the high and low side valves to the high vacuum manifold set. With the valve on the charging cylinder closed, open the manifold valve to the cylinder.
4. Evacuate the system to at least 29 inches gauge before opening valve to thermocouple vacuum gauge.
5. Continue to evacuate to a maximum of 250 microns. Close valve to vacuum pump and watch rate of rise. If vacuum does not rise above 1500 microns in three to five minutes, system can be considered properly evacuated.
6. If thermocouple vacuum gauge continues to rise and levels off at about 5000 microns, moisture and non-condensables are still present. If gauge continues to rise a leak is present. Repair and re-evacuate.
7. Close valve to thermocouple vacuum gauge and vacuum pump. Shut off pump and prepare to charge.

S-103 CHARGING



WARNING

REFRIGERANT UNDER PRESSURE!

- * Do not overcharge system with refrigerant.
 - * Do not operate unit in a vacuum or at negative pressure.
- Failure to follow proper procedures may cause property damage, personal injury or death.



CAUTION

Only use refrigerant certified to AHRI standards. Used refrigerant may cause compressor damage. The manufacturer is not responsible for damage or the need for repairs resulting from the use of unapproved refrigerant types or used or recycled refrigerant. Most portable machines cannot clean used refrigerant to meet AHRI standards.

Charge the system with the exact amount of refrigerant.

Refer to the specification section or check the unit nameplates for the correct refrigerant charge.

An inaccurately charged system will cause future problems.

1. Using a quality set of charging scales, weigh the proper amount of refrigerant for the system. Allow liquid refrigerant only to enter the high side.
2. After the system will take all it will take, close the valve on the high side of the charging manifold.
3. Start the system and charge the balance of the refrigerant through the low side.

NOTE: R410A should be drawn out of the storage container or drum in liquid form due to its fractionation properties, but should be "Flashed" to its gas state before entering the system. There are commercially available restriction devices that fit into the system charging hose set to accomplish this. DO NOT charge liquid R410A into the compressor.

4. With the system still running, close the valve on the charging cylinder. At this time, you may still have some liquid refrigerant in the charging cylinder hose and will definitely have liquid in the liquid hose. Reseat the liquid line core. Slowly open the high side manifold valve and transfer the liquid refrigerant from the liquid line hose and charging cylinder hose into the suction service valve port. CAREFUL: Watch so that liquid refrigerant does not enter the compressor.

SERVICING

FINAL CHARGE ADJUSTMENT

The outdoor temperature must be 60°F or higher. Set the room thermostat to COOL, fan switch to AUTO, and set the temperature control well below room temperature.

After system has stabilized per startup instructions, compare the operating pressures and outdoor unit amp draw to the numbers listed in the spec sheet manual. If pressures and amp draw are too low, add charge. If pressures and amp draw are too high, remove charge. Check subcooling and superheat as detailed in the following section.

5. With the system still running, remove hose and reinstall both valve caps.
6. Check system for leaks.

Due to their design, Scroll compressors are inherently more tolerant of liquid refrigerant.

NOTE: Even though the compressor section of a Scroll compressor is more tolerant of liquid refrigerant, continued floodback or flooded start conditions may wash oil from the bearing surfaces causing premature bearing failure.

The condition of the valves or scroll flanks is checked in the following manner.

1. Attach gauges to the high and low side of the system.
2. Start the system and run a Cooling Performance Test.

If the test shows-

- ⇒ Below normal high side pressure.
- ⇒ Above normal low side pressure.
- ⇒ Low temperature difference across coil.
- ⇒ Low amp draw at compressor.

-and the charge is correct. The compressor is faulty - replace the compressor.

S-104 CHECKING COMPRESSOR EFFICIENCY

The reason for compressor inefficiency is broken or damaged scroll flanks on Scroll compressors, reducing the ability of the compressor to pump refrigerant vapor.

During the "OFF" cycle, the high side pressure bleeds to the low side through the fixed orifice restriction device. Check equalization time as follows:

1. Attach a gauge manifold to the suction and liquid line dill valves.
2. Start the system and allow the pressures to stabilize.
3. Stop the system and check the time it takes for the high and low pressure gauge readings to equalize.

If it takes more than seven (7) minutes to equalize, the restrictor device is inoperative. Replace, install a liquid line drier, evacuate and recharge.

S-106 OVERFEEDING

Overfeeding by the expansion valve results in high suction pressure, cold suction line, and possible liquid slugging of the compressor.

If these symptoms are observed:

1. Check for an overcharged unit by referring to the cooling performance charts in the spec sheet manual.
2. Check the operation of the power element in the valve as explained in S-110 Checking Expansion Valve Operation.
3. Check for restricted or plugged equalizer tube.

S-108 CHECKING SUPERHEAT

Refrigerant gas is considered superheated when its temperature is higher than the saturation temperature corresponding to its pressure. The degree of superheat equals the degrees of temperature increase above the saturation temperature at existing pressure. See Temperature - Pressure Chart .



CAUTION

To prevent personal injury, carefully connect and disconnect manifold gauge hoses. Escaping liquid refrigerant can cause burns. Do not vent refrigerant to atmosphere. Recover during system repair or final unit disposal.

1. Run system at least 10 minutes to allow pressure to stabilize.
2. Temporarily install thermometer on suction (large) line near compressor with adequate contact and insulate for best possible reading.
3. Refer to the superheat table provided for proper system superheat. Add charge to lower superheat or recover charge to raise superheat.

Superheat Formula = Suct. Line Temp. - Sat. Suct. Temp.

SERVICING

Ambient Condenser Inlet Temp (°F Drybulb)	Return Air Temp. (°F Drybulb)				
	65	70	75	80	85
100	---	---	---	10	10
95	---	---	10	10	10
90	---	---	12	15	18
85	---	10	13	17	20
80	---	10	15	21	26
75	10	13	17	25	29
70	10	17	20	28	32
65	13	19	26	32	35
60	17	25	30	33	37

SYSTEM SUPERHEAT

EXAMPLE:

- A. Suction Pressure = 143
- B. Corresponding Temp. °F. = 50
- C. Thermometer on Suction Line = 59°F.

To obtain the degrees temperature of superheat, subtract 50.0 from 59.0°F.

The difference is 9° Superheat. The 9° Superheat would fall in the ± range of allowable superheat.

S-109 CHECKING SUBCOOLING

Refrigerant liquid is considered subcooled when its temperature is lower than the saturation temperature corresponding to its pressure. The degree of subcooling equals the degrees of temperature decrease below the saturation temperature at the existing pressure.

1. Attach an accurate thermometer or preferably a thermocouple type temperature tester to the liquid line close to the pressure switch.
2. Install a high side pressure gauge on the high side (liquid) service valve at the front of the unit.
3. Record the gauge pressure and the temperature of the line.
4. Compare the hi-pressure reading to the "Required Liquid Line Temperature" chart on the preceding page. Find the hi-pressure value on the left column. Follow that line right to the column under the design subcooling value. Where the two intersect is the required liquid line temperature.
Alternately you can convert the liquid line pressure gauge reading to temperature by finding the gauge reading in Temperature - Pressure Chart and reading to the left, find the temperature in the °F. Column.
5. The difference between the thermometer reading and pressure to temperature conversion is the amount of subcooling.

Add charge to raise subcooling. Recover charge to lower subcooling.

Subcooling Formula = Sat. Liquid Temp. - Liquid Line Temp.

EXAMPLE:

- A. Liquid Line Pressure = 417
- B. Corresponding Temp. °F. = 120°
- C. Thermometer on Liquid line = 109°F.

To obtain the amount of subcooling, subtract 109°F from 120°F.

The difference is 11° subcooling. See the specification sheet for the design subcooling range for your unit.

See R410A Pressure vs. Temperature chart.

S-110 CHECKING EXPANSION VALVE OPERATION

1. Remove the remote bulb of the expansion valve from the suction line.
2. Start the system and cool the bulb in a container of ice water, closing the valve. As you cool the bulb, the suction pressure should fall and the suction temperature will rise.
3. Next warm the bulb in your hand. As you warm the bulb, the suction pressure should rise and the suction temperature will fall.
4. If a temperature or pressure change is noticed, the expansion valve is operating. If no change is noticed, the valve is restricted, the power element is faulty, or the equalizer tube is plugged.
5. Capture the charge, replace the valve and drier, evacuate and recharge.

S-112 CHECKING RESTRICTED LIQUID LINE

When the system is operating, the liquid line is warm to the touch. If the liquid line is restricted, a definite temperature drop will be noticed at the point of restriction. In severe cases, frost will form at the restriction and extend down the line in the direction of the flow.

Discharge and suction pressures will be low, giving the appearance of an undercharged unit. However, the unit will have normal to high subcooling. Locate the restriction, replace the restricted part, replace drier, evacuate and recharge.

SERVICING

S-113A OVERCHARGE OF REFRIGERANT

An overcharge of refrigerant is normally indicated by an excessively high head pressure.

An evaporator coil, using an expansion valve metering device, will basically modulate and control a flooded evaporator and prevent liquid refrigerant return to the compressor.

An evaporator coil, using a fixed orifice restrictor device (flowrator) metering device, could allow liquid refrigerant to return to the compressor under extreme overcharge conditions.

Also with a fixed orifice restrictor device (flowrator) metering device, extreme cases of insufficient indoor air can cause icing of the indoor coil and liquid refrigerant return to the compressor, but the head pressure would be lower.

There are other causes for high head pressure which may be found in the "Service Problem Analysis Guide."

If other causes check out normal, an overcharge or a system containing non-condensables would be indicated.

If this system is observed:

1. Start the system.
2. Remove and capture small quantities of refrigerant as from the suction line access fitting until the head pressure is reduced to normal.
3. Observe the system while running a cooling performance test. If a shortage of refrigerant is indicated, then the system contains non-condensables.

S-113B UNDERCHARGE OF REFRIGERANT

An undercharge of refrigerant is normally indicated by an excessively low head pressure. An evaporator coil, using an expansion valve metering device, will open fully due to a lack of superheat provided by the system. An evaporator coil, using a fixed orifice restrictor device (flowrator) metering device, will not flash liquid refrigerant entering the evaporator coil under extreme undercharge conditions. Also with a fixed orifice restrictor device (flowrator) metering device, extreme cases of insufficient indoor air can cause icing of the indoor coil and higher than normal suction temperature return to the compressor, which can cause the compressor to overheat.

"If other causes check out normal, an undercharge or a system containing non-condensables would be indicated.

If this system is observed:

1. Start the system.
2. Add small quantities of refrigerant as from the suction line access fitting until the head pressure is increased to normal.

Or

Recover all refrigerant, evacuate system and recharge the system with the amount of refrigerant indicated on the unit's nameplate.

3. Observe the system while running a cooling performance test. If a shortage of refrigerant is indicated, then the system contains non-condensables.

(HEAT PUMP) UNDERCHARGE

An undercharged heat pump on the heating cycle will cause low discharge pressure resulting in low suction pressure and frost accumulation on the outdoor coil.

S-114 NON-CONDENSABLES

If non-condensables are suspected, shut down the system and allow the pressures to equalize. Wait at least 15 minutes. Compare the pressure to the temperature of the coldest coil since this is where most of the refrigerant will be. If the pressure indicates a higher temperature than that of the coil temperature, non-condensables are present.

Non-condensables are removed from the system by first removing the refrigerant charge, replacing and/or installing liquid line drier, evacuating and recharging.

SERVICING

Pressure vs. Temperature Chart

R-410A

PSIG	°F	PSIG	°F	PSIG	°F	PSIG	°F	PSIG	°F	PSIG	°F
12	-37.7	114.0	37.8	216.0	74.3	318.0	100.2	420.0	120.7	522.0	137.6
14	-34.7	116.0	38.7	218.0	74.9	320.0	100.7	422.0	121.0	524.0	137.9
16	-32.0	118.0	39.5	220.0	75.5	322.0	101.1	424.0	121.4	526.0	138.3
18	-29.4	120.0	40.5	222.0	76.1	324.0	101.6	426.0	121.7	528.0	138.6
20	-36.9	122.0	41.3	224.0	76.7	326.0	102.0	428.0	122.1	530.0	138.9
22	-24.5	124.0	42.2	226.0	77.2	328.0	102.4	430.0	122.5	532.0	139.2
24	-22.2	126.0	43.0	228.0	77.8	330.0	102.9	432.0	122.8	534.0	139.5
26	-20.0	128.0	43.8	230.0	78.4	332.0	103.3	434.0	123.2	536.0	139.8
28	-17.9	130.0	44.7	232.0	78.9	334.0	103.7	436.0	123.5	538.0	140.1
30	-15.8	132.0	45.5	234.0	79.5	336.0	104.2	438.0	123.9	540.0	140.4
32	-13.8	134.0	46.3	236.0	80.0	338.0	104.6	440.0	124.2	544.0	141.0
34	-11.9	136.0	47.1	238.0	80.6	340.0	105.1	442.0	124.6	548.0	141.6
36	-10.1	138.0	47.9	240.0	81.1	342.0	105.4	444.0	124.9	552.0	142.1
38	-8.3	140.0	48.7	242.0	81.6	344.0	105.8	446.0	125.3	556.0	142.7
40	-6.5	142.0	49.5	244.0	82.2	346.0	106.3	448.0	125.6	560.0	143.3
42	-4.5	144.0	50.3	246.0	82.7	348.0	106.6	450.0	126.0	564.0	143.9
44	-3.2	146.0	51.1	248.0	83.3	350.0	107.1	452.0	126.3	568.0	144.5
46	-1.6	148.0	51.8	250.0	83.8	352.0	107.5	454.0	126.6	572.0	145.0
48	0.0	150.0	52.5	252.0	84.3	354.0	107.9	456.0	127.0	576.0	145.6
50	1.5	152.0	53.3	254.0	84.8	356.0	108.3	458.0	127.3	580.0	146.2
52	3.0	154.0	54.0	256.0	85.4	358.0	108.8	460.0	127.7	584.0	146.7
54	4.5	156.0	54.8	258.0	85.9	360.0	109.2	462.0	128.0	588.0	147.3
56	5.9	158.0	55.5	260.0	86.4	362.0	109.6	464.0	128.3	592.0	147.9
58	7.3	160.0	56.2	262.0	86.9	364.0	110.0	466.0	128.7	596.0	148.4
60	8.6	162.0	57.0	264.0	87.4	366.0	110.4	468.0	129.0	600.0	149.0
62	10.0	164.0	57.7	266.0	87.9	368.0	110.8	470.0	129.3	604.0	149.5
64	11.3	166.0	58.4	268.0	88.4	370.0	111.2	472.0	129.7	608.0	150.1
66	12.6	168.0	59.0	270.0	88.9	372.0	111.6	474.0	130.0	612.0	150.6
68	13.8	170.0	59.8	272.0	89.4	374.0	112.0	476.0	130.3	616.0	151.2
70	15.1	172.0	60.5	274.0	89.9	376.0	112.4	478.0	130.7	620.0	151.7
72	16.3	174.0	61.1	276.0	90.4	378.0	112.6	480.0	131.0	624.0	152.3
74	17.5	176.0	61.8	278.0	90.9	380.0	113.1	482.0	131.3	628.0	152.8
76	18.7	178.0	62.5	280.0	91.4	382.0	113.5	484.0	131.6	632.0	153.4
78	19.8	180.0	63.1	282.0	91.9	384.0	113.9	486.0	132.0	636.0	153.9
80	21.0	182.0	63.8	284.0	92.4	386.0	114.3	488.0	132.3	640.0	154.5
82	22.1	184.0	64.5	286.0	92.8	388.0	114.7	490.0	132.6	644.0	155.0
84	23.2	186.0	65.1	288.0	93.3	390.0	115.0	492.0	132.9	648.0	155.5
86	24.3	188.0	65.8	290.0	93.8	392.0	115.5	494.0	133.3	652.0	156.1
88	25.4	190.0	66.4	292.0	94.3	394.0	115.8	496.0	133.6	656.0	156.6
90	26.4	192.0	67.0	294.0	94.8	396.0	116.2	498.0	133.9	660.0	157.1
92	27.4	194.0	67.7	296.0	95.2	398.0	116.6	500.0	134.0	664.0	157.7
94	28.5	196.0	68.3	298.0	95.7	400.0	117.0	502.0	134.5	668.0	158.2
96	29.5	198.0	68.9	300.0	96.2	402.0	117.3	504.0	134.8	672.0	158.7
98	30.5	200.0	69.5	302.0	96.6	404.0	117.7	506.0	135.2	676.0	159.2
100	31.2	202.0	70.1	304.0	97.1	406.0	118.1	508.0	135.5	680.0	159.8
102	32.2	204.0	70.7	306.0	97.5	408.0	118.5	510.0	135.8	684.0	160.3
104	33.2	206.0	71.4	308.0	98.0	410.0	118.8	512.0	136.1	688.0	160.8
106	34.1	208.0	72.0	310.0	98.4	412.0	119.2	514.0	136.4	692.0	161.3
108	35.1	210.0	72.6	312.0	98.9	414.0	119.6	516.0	136.7	696.0	161.8
110	35.5	212.0	73.2	314.0	99.3	416.0	119.9	518.0	137.0		
112	36.9	214.0	73.8	316.0	99.7	418.0	120.3	520.0	137.3		

*Based on ALLIED SIGNAL Data

SERVICING

REQUIRED LIQUID LINE TEMPERATURE						
LIQUID PRESSURE AT ACCESS FITTING (PSIG)	REQUIRED SUBCOOLING TEMPERATURE (°F)					
	8	10	12	14	16	18
189	58	56	54	52	50	48
195	60	58	56	54	52	50
202	62	60	58	56	54	52
208	64	62	60	58	56	54
215	66	64	62	60	58	56
222	68	66	64	62	60	58
229	70	68	66	64	62	60
236	72	70	68	66	64	62
243	74	72	70	68	66	64
251	76	74	72	70	68	66
259	78	76	74	72	70	68
266	80	78	76	74	72	70
274	82	80	78	76	74	72
283	84	82	80	78	76	74
291	86	84	82	80	78	76
299	88	86	84	82	80	78
308	90	88	86	84	82	80
317	92	90	88	86	84	82
326	94	92	90	88	86	84
335	96	94	92	90	88	86
345	98	96	94	92	90	88
354	100	98	96	94	92	90
364	102	100	98	96	94	92
374	104	102	100	98	96	94
384	106	104	102	100	98	96
395	108	106	104	102	100	98
406	110	108	106	104	102	100
416	112	110	108	106	104	102
427	114	112	110	108	106	104
439	116	114	112	110	108	106
450	118	116	114	112	110	108
462	120	118	116	114	112	110
474	122	120	118	116	114	112
486	124	122	120	118	116	114
499	126	124	122	120	118	116
511	128	126	124	122	120	118

SERVICING

S-115 COMPRESSOR BURNOUT

When a compressor burns out, high temperature develops causing the refrigerant, oil and motor insulation to decompose forming acids and sludge.

If a compressor is suspected of being burned-out, attach a refrigerant hose to the liquid line dill valve and properly remove and dispose of the refrigerant.



NOTICE

Violation of EPA regulations may result in fines or other penalties.

Now determine if a burn out has actually occurred. Confirm by analyzing an oil sample using a Sporlan Acid Test Kit, AK-3 or its equivalent.

Remove the compressor and obtain an oil sample from the suction stub. If the oil is not acidic, either a burnout has not occurred or the burnout is so mild that a complete clean-up is not necessary.

If acid level is unacceptable, the system must be cleaned by using the clean-up drier method.



CAUTION

Do not allow the sludge or oil to contact the skin. Severe burns may result.

NOTE: Daikin does NOT approve the flushing method using R-11 refrigerant.

SUCTION LINE DRIER CLEAN-UP METHOD

The POE oils used with R410A refrigerant is an excellent solvent. In the case of a burnout, the POE oils will remove any burnout residue left in the system. If not captured by the refrigerant filter, they will collect in the compressor or other system components, causing a failure of the replacement compressor and/or spread contaminants throughout the system, damaging additional components.

The suction line filter drier should be installed as close to the compressor suction fitting as possible. The filter must be accessible and be rechecked for a pressure drop after the system has operated for a time. It may be necessary to use new tubing and form as required.

NOTE: At least twelve (12) inches of the suction line immediately out of the compressor stub must be discarded due to burned residue and contaminates.

1. Remove the liquid line drier and expansion valve.
2. Purge all remaining components with dry nitrogen or carbon dioxide until clean.
3. Install new components **including** liquid line drier.
4. Braze all joints, leak test, evacuate, and recharge system.
5. Start up the unit and record the pressure drop across the drier.
6. Continue to run the system for a minimum of twelve (12) hours and recheck the pressure drop across the drier. Pressure drop should not exceed 6 PSIG.
7. Continue to run the system for several days, repeatedly checking pressure drop across the suction line drier. If the pressure drop never exceeds the 6 PSIG, the drier has trapped the contaminants. Remove the suction line drier from the system.
8. If the pressure drop becomes greater, then it must be replaced and steps 5 through 9 repeated until it does not exceed 6 PSIG.

NOTICE: Regardless, the cause for burnout must be determined and corrected before the new compressor is started.

S-200 CHECKING EXTERNAL STATIC PRESSURE

The minimum and maximum allowable duct static pressure is found in the Specifications Sheet Manual.

Too great of an external static pressure will result in insufficient air that can cause icing of the coil, whereas too much air can cause poor humidity control, and condensate to be pulled off the evaporator coil causing condensate leakage. Too much air can cause motor overloading and in many cases this constitutes a poorly designed system. To determine proper air movement, proceed as follows:

1. Using a draft gauge (inclined manometer) measure the static pressure of the return duct at the inlet of the unit, (Negative Pressure).
2. Measure the static pressure of the supply duct, (Positive Pressure).
3. Add the two readings together.

NOTE: Both readings may be taken simultaneously and read directly on the manometer if so desired.

4. Consult proper table for quantity of air.

If the external static pressure exceeds the minimum or maximum allowable statics, check for closed dampers, dirty filters, undersized or poorly laid out ductwork.

SERVICING

S-205 CHECKING BELT TENSION

NOTE: Section on high static tables may require a field motor change.

BELT DRIVE TENSION AND ALIGNMENT ADJUSTMENT

Check drive for adequate run-in belt tension. Correct belt tension is very important. A belt that is loose will have a substantially shorter life, and a belt that is too tight may cause premature motor and bearing failure. Correct belt tension on these units can be checked by measuring the force required to deflect the belt 1/8" at the midpoint of the span length (Figure 21). Belt tension force can be measured using a belt tension checker, available through most belt manufacturers. The correct deflection force is 5 lbs. for a new belt and 3.5 lbs. for a belt that has been run in. New belt tension includes initial belt stretch.

When new V-belts are installed on a drive the initial tension will drop rapidly during the first few hours. Check tension frequently during the first 24 hours of operation.

Subsequent retensioning should fall between the minimum and maximum force. To determine the deflection distance from the normal position, use a straightedge or stretch a cord from sheave to sheave to use as a reference line. On multiple belt drives, an adjacent undeflected belt can be used as a reference.

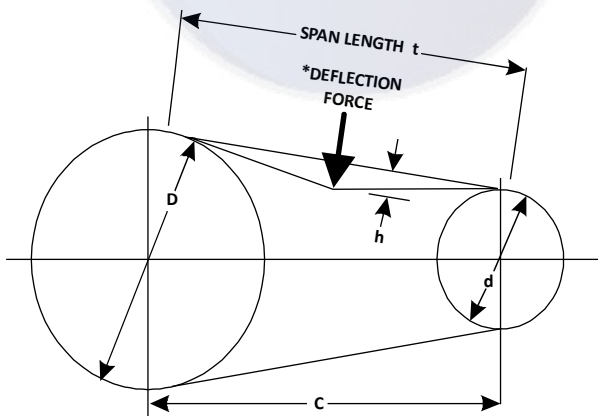

***APPLY FORCE TO THE CENTER OF THE SPAN.**

- t = Span length, inches
- C = Center distance, inches
- D = Larger sheave diameter, inches
- d = Smaller sheave diameter, inches
- h = Deflection height, inches

DRIVE BELT TENSION ADJUSTMENT

15&20 TON MODELS

MODEL	TYPE		SHEAVE DIAMETER (in)	DEFLECTION FORCE (lbs)		DEFLECTION (in)
	BELT	DRIVE		Used	New	
15 Ton	B, BA	Standard	4.3 to 5.5	5.5 ± .5	8.2 ± .5	1/4 ± 1/16
20 Ton 25 Ton	B, BA	Standard	4.3 to 5.5	5.5 ± .5	8.2 ± .5	1/4 ± 1/16

RECOMMENDED POUNDS OF FORCE PER BELT

S-207 MOTOR SHEAVE ADJUSTMENTS

VL, VM & ZVP VARIABLE PITCH KEY TYPE MOTOR SHEAVES

The driving and driven motor sheaves should be in alignment with each other and the shafts parallel.

VL & VM SHEAVES ADJUSTMENT

1. Loosen set screw "B" using a 5/32" Allen key.
2. Making half or full turns from closed position, adjust sheave pitch diameter for desired speed. DO NOT OPEN MORE THAN SIX FULL TURNS.
3. Tighten set screw "B" securely over flat.
4. Carefully put on belts and adjust belt tension. DO NOT FORCE BELTS OVER GROOVES.
5. Ensure all keys are in place and the set screws tight before starting drive. Recheck set screws and belt tension after 24 hours service.

NOTE: Future adjustments should be made by loosening the belt tension and increasing or decreasing the pitch diameter of the sheave by half or full turns as required. Readjust belt tension before starting drive.

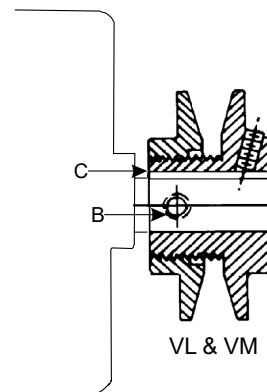

NOTE: Do not operate sheave with flange projecting beyond the hub end.

SERVICING

PCBAG123 IGNITION CONTROL TROUBLESHOOTING FLOWCHART

Steady On - Normal

No Light - Check Power or Wiring

1 Flash – Ignition Lockout (3 Failed Ignition Trials)

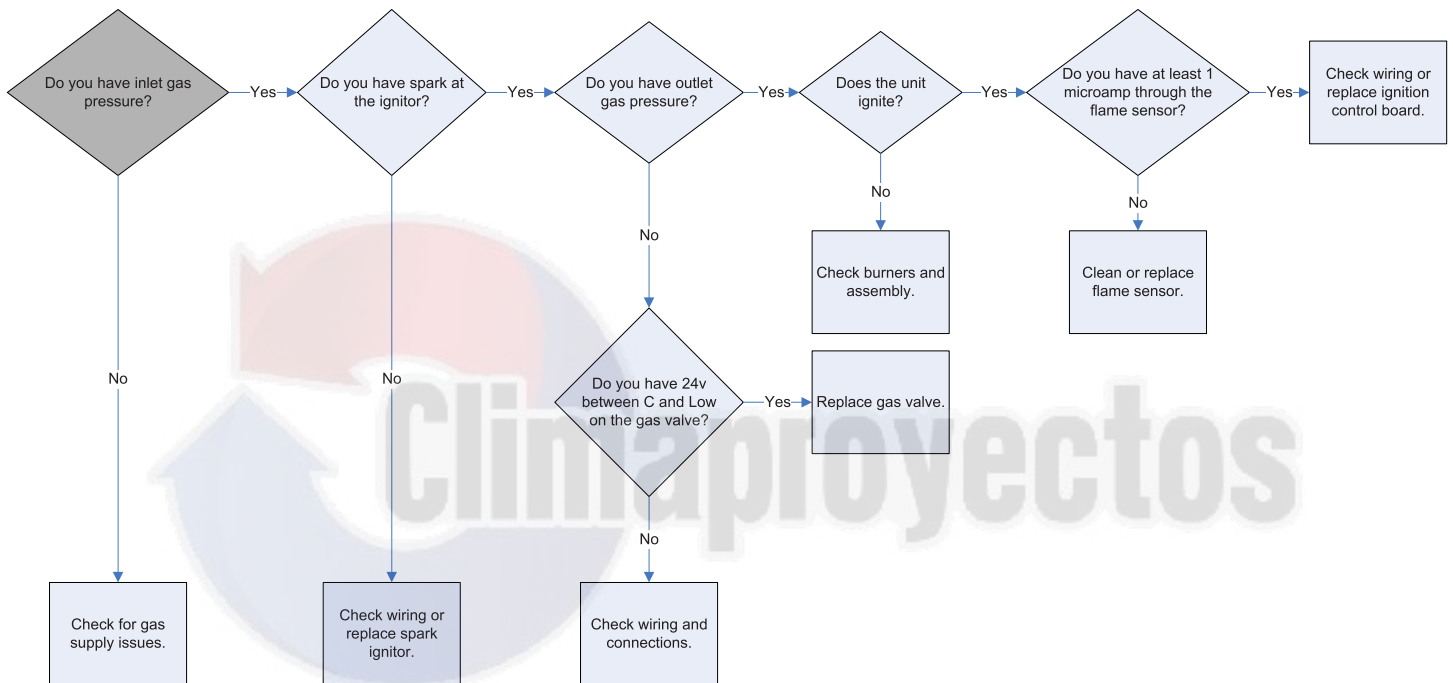

SERVICING

2 Flash – Pressure Switch Stuck Closed

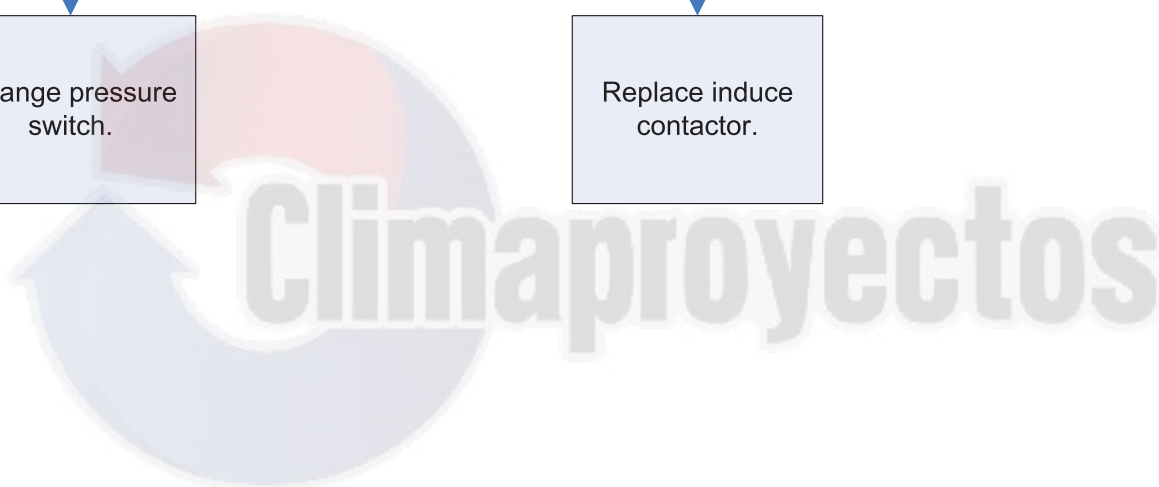
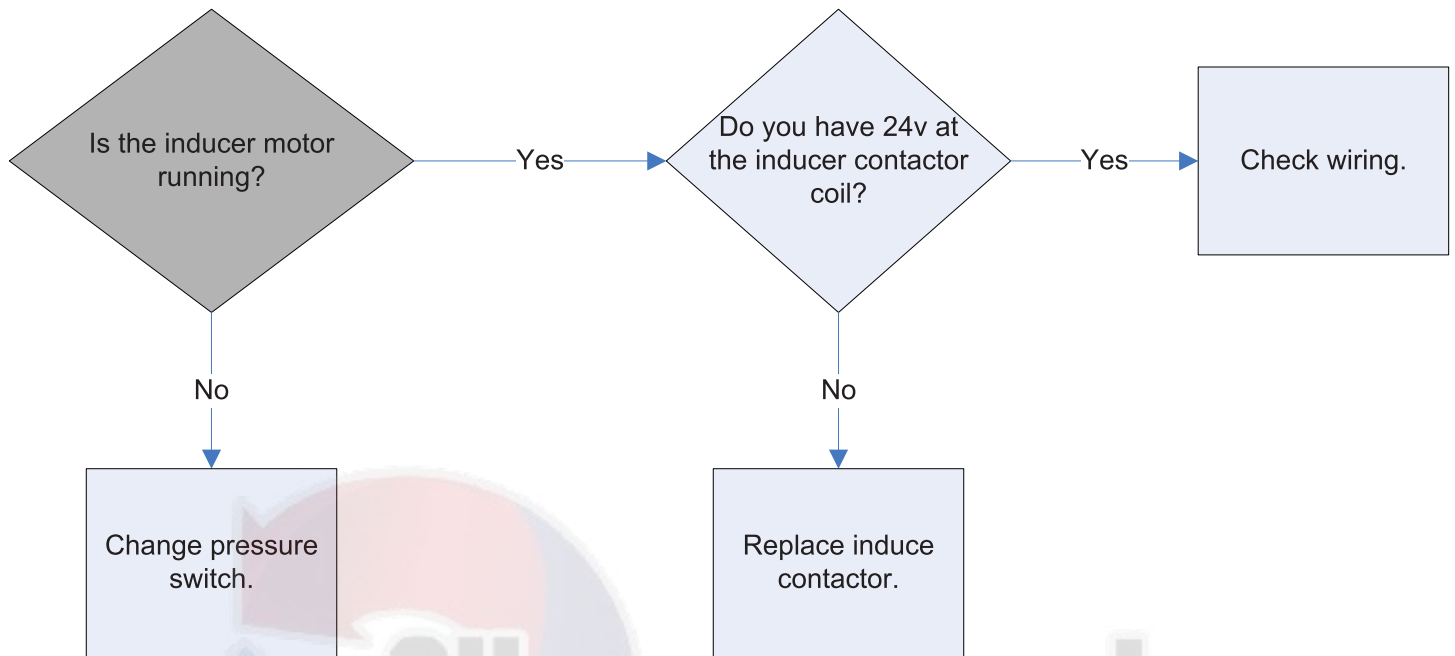

SERVICING

3 Flash – Pressure Switch Stuck Open

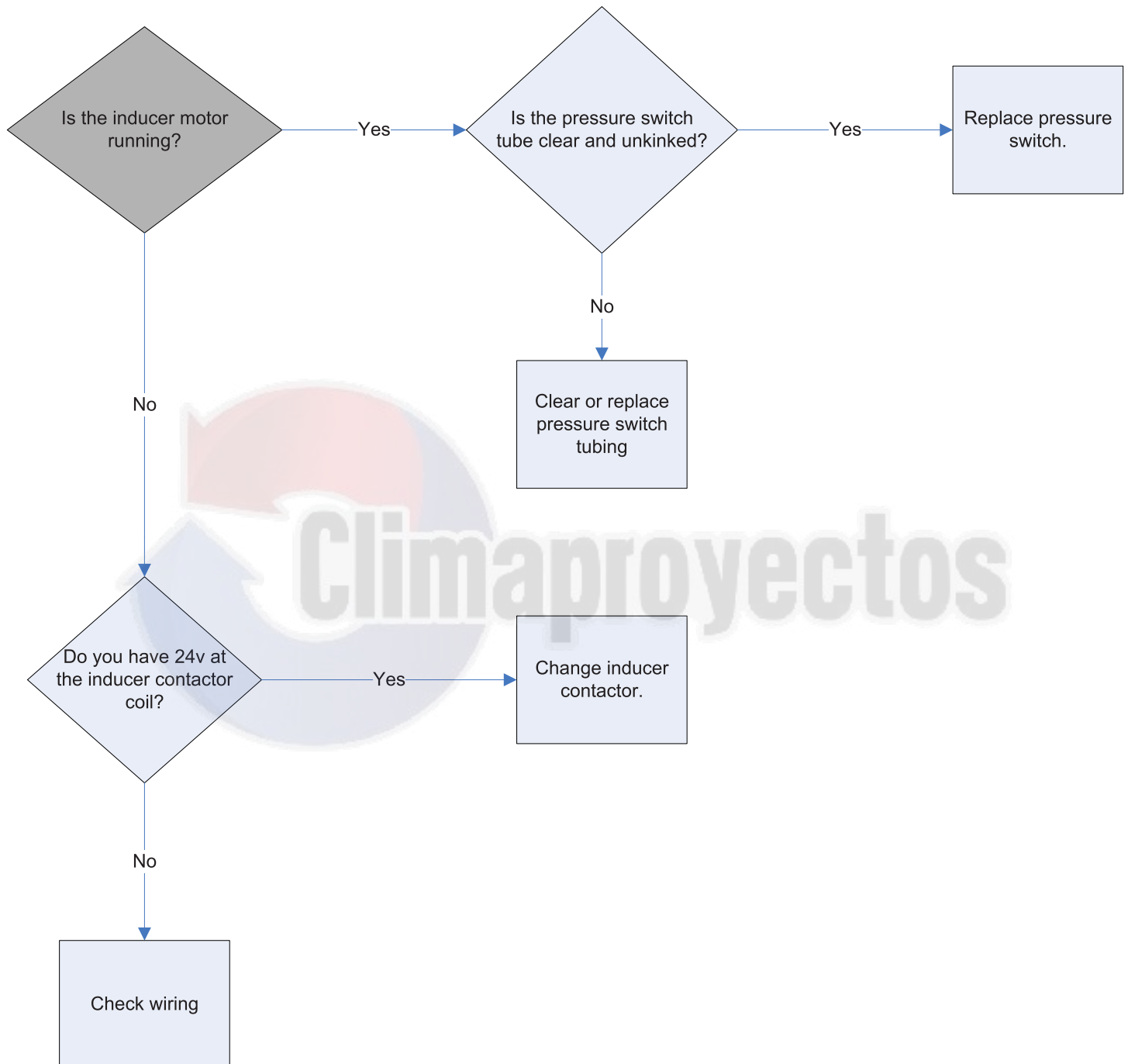

SERVICING

4 Flash – Open High Temperature Limit

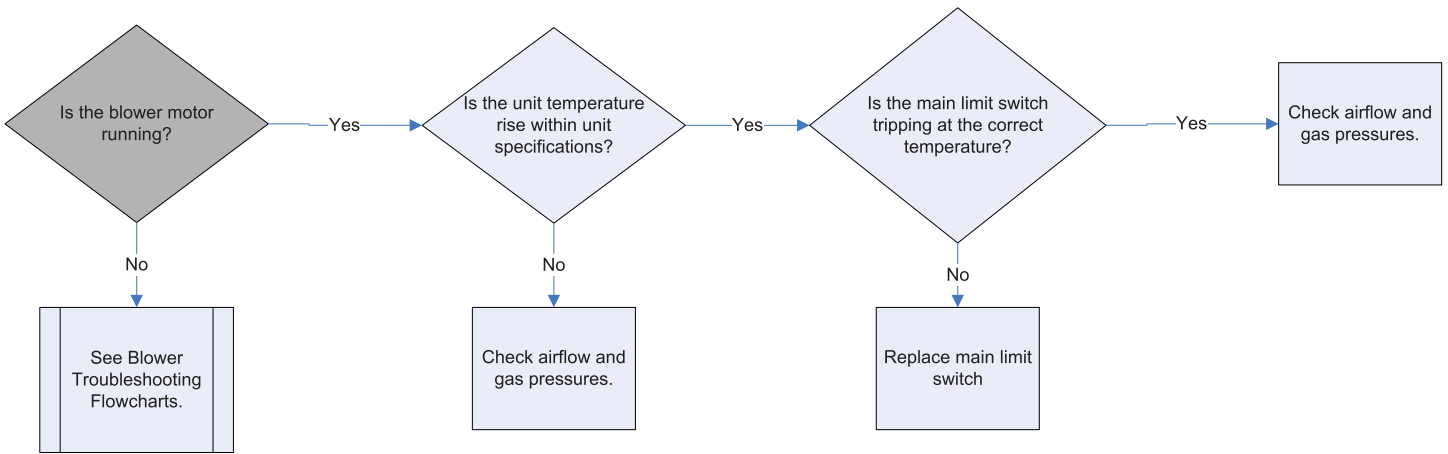

5 Flash – Flame Detected with Gas Valve De-Energized

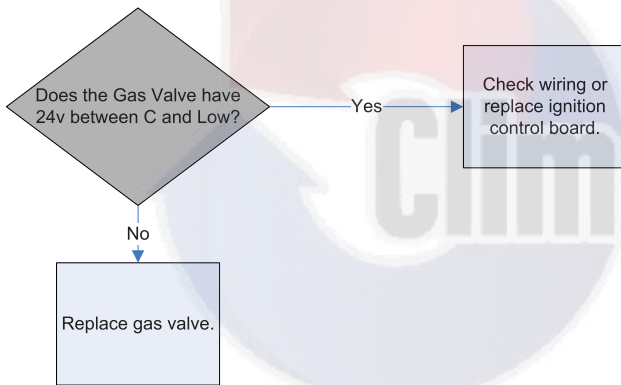

6 Flash – Compressor Short Cycle Delay Active (3 minute delay)

SERVICING

ULTRA LOW NOX

LED ACTIVITY	RED	AMBER	GREEN
BOOT-UP	ON	ON	ON
STEADY ON	CONTROL FAULT DETECTED	OEM TEST MODE	STANDBY NORMAL OPERATION NO THERMOSTAT REQUESTS
RAPID FLASH	_____	FIELD TEST MODE	CLEAR ERROR HISTORY
1 FLASH	IGNITION RETRIES EXCEEDED	LOW FLAME SENSE	CALL FOR HEATING
2 FLASH	PRESSURE SENSOR NULL ERROR: INCONSISTENT READING WITH INDUCER OFF	ID PLUG FAILURE	CALL FOR COOLING
3 FLASH	PRESSURE SENSOR SPAN ERROR: INCONSISTENT READING WITH INDUCER ON, OR INDUCER FAILS TO REACH TARGET PRESSURE	CONTROL FUSE OPEN	CONTINUOUS FAN OPERATION
4 FLASH	HIGH LIMIT SWITCH OPEN	_____	_____
5 FLASH	FLAME PRESENT WITH GAS VALVE OFF	_____	_____
6 FLASH	NORMALLY CLOSED BURNER SWITCH/AUXILIARY SWITCH OPEN	_____	_____
7 FLASH	GAS VALVE CIRCUIT SHORTED	_____	_____
10 FLASH	HIGH LIMIT SWITCH RECOVERY TIMER EXPIRED	_____	_____
OFF NO LED ACTIVITY	NO 24 VAC POWER TO CONTROL		

SERVICING

ULN ONLY

LED Flashing - None

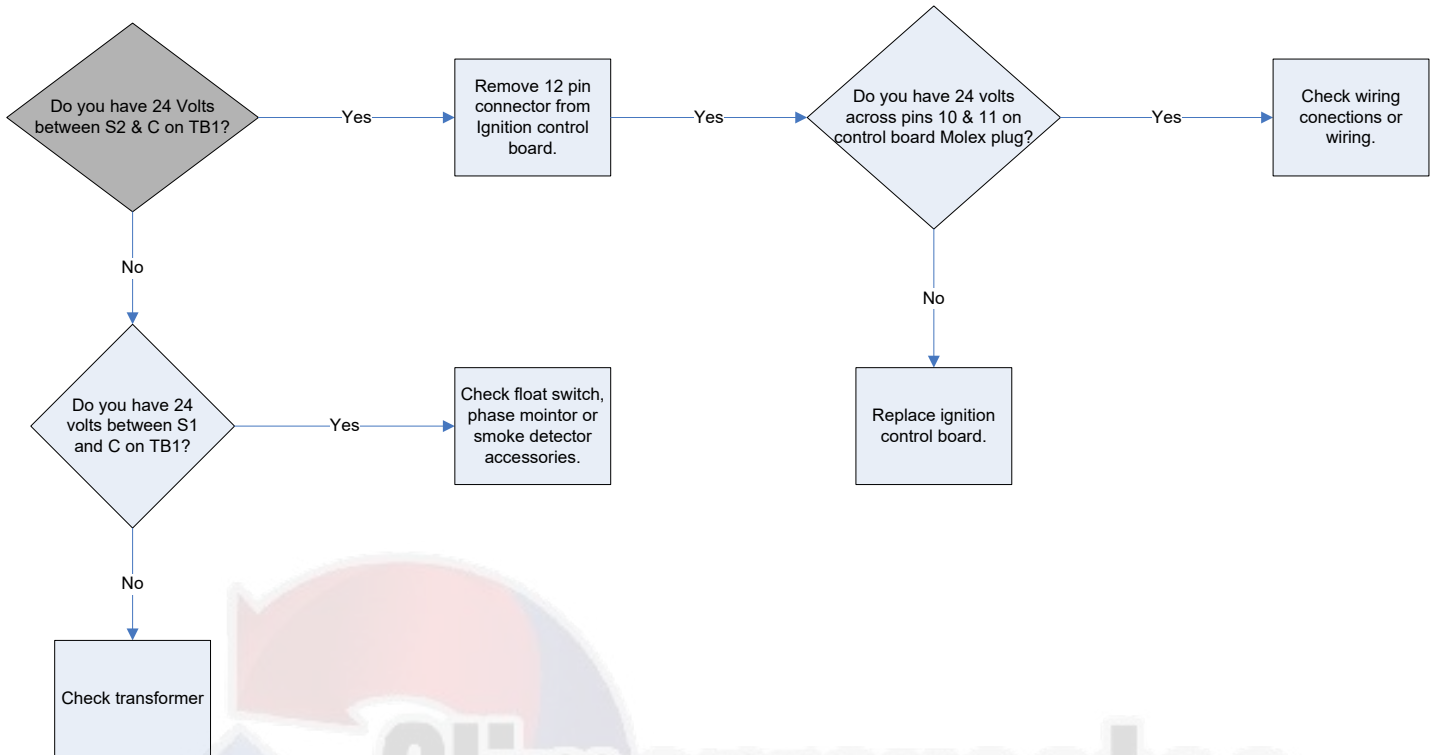

SERVICING

ULN ONLY

LED Flashing – Steady Red

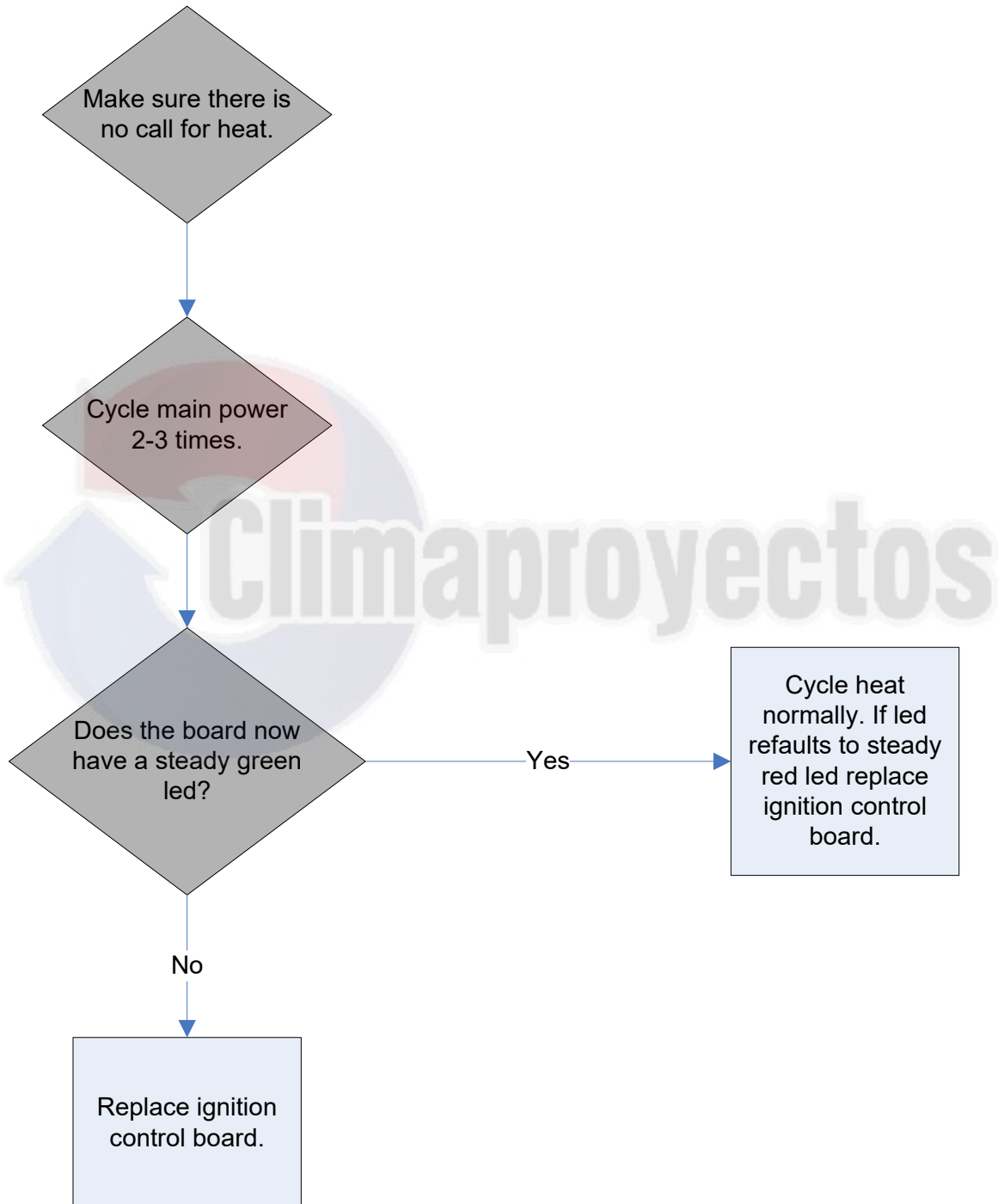

SERVICING

ULN ONLY

LED Flashing – 1 Red

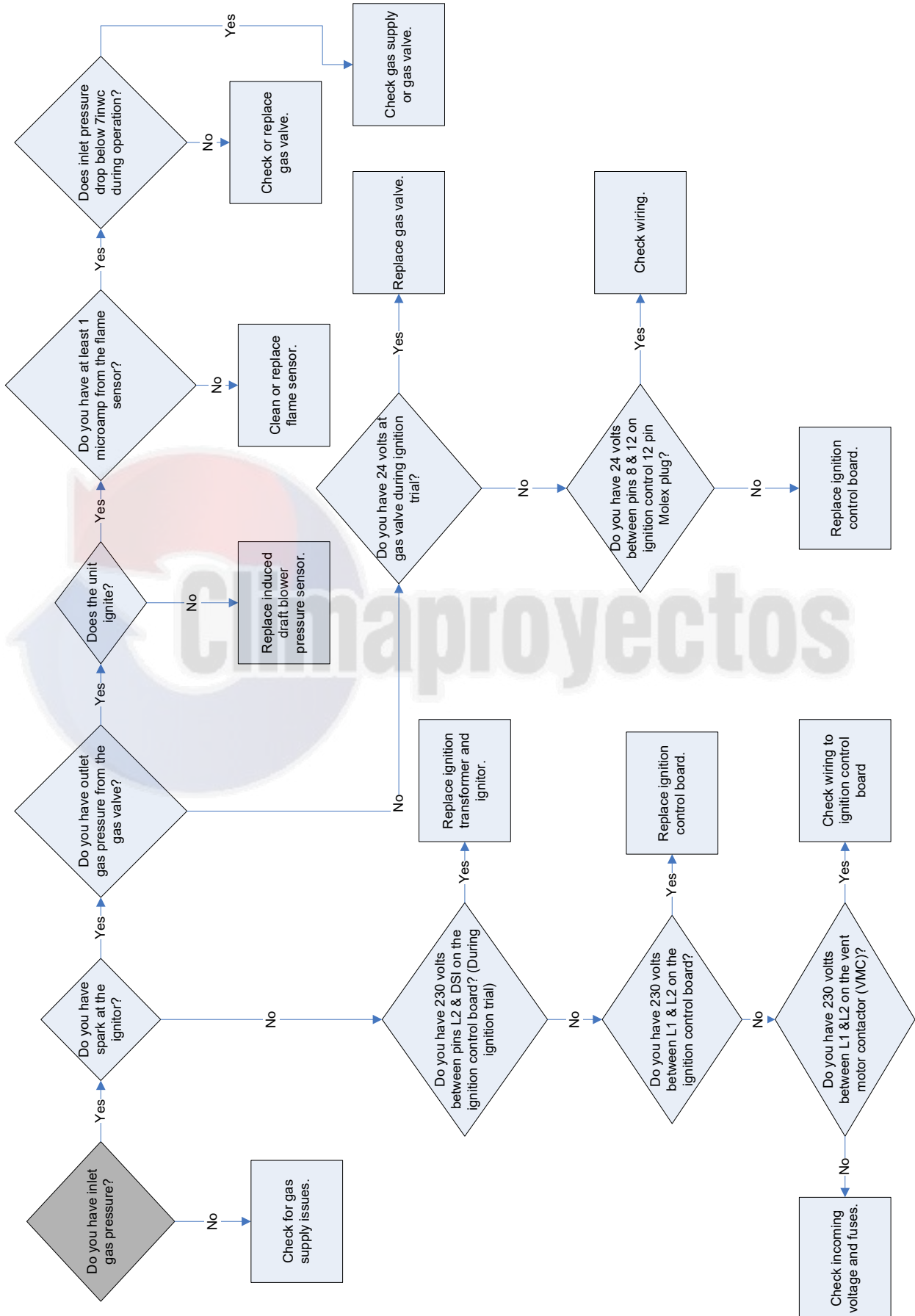

SERVICING

ULN ONLY

LED Flashing – 3 Red

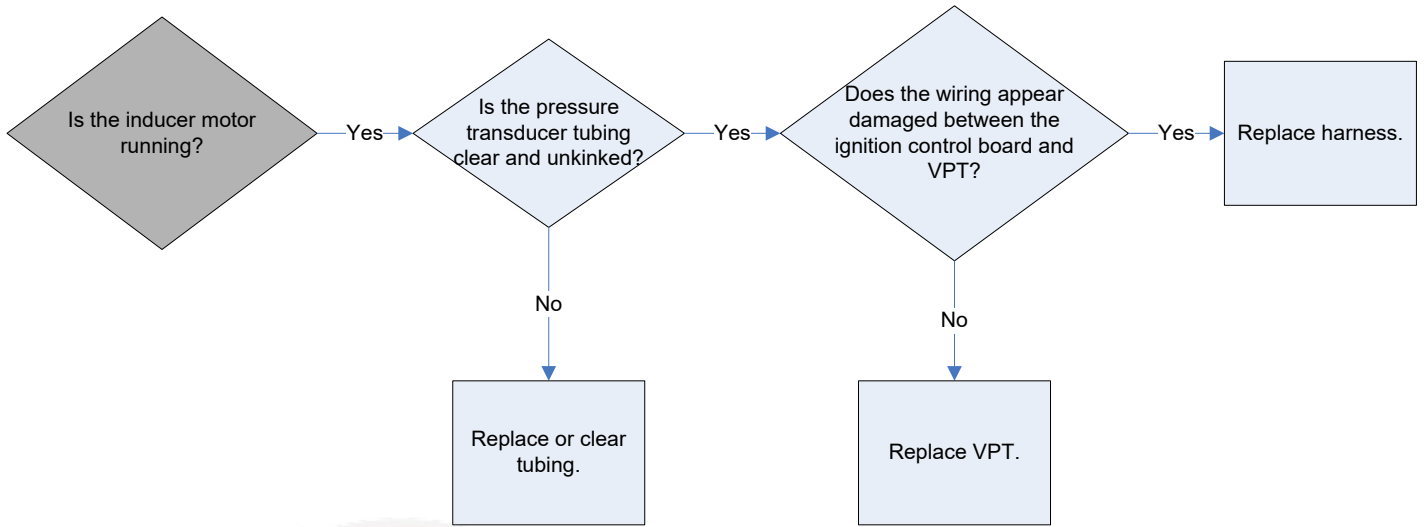

SERVICING

ULN ONLY

LED Flashing – 6 Red

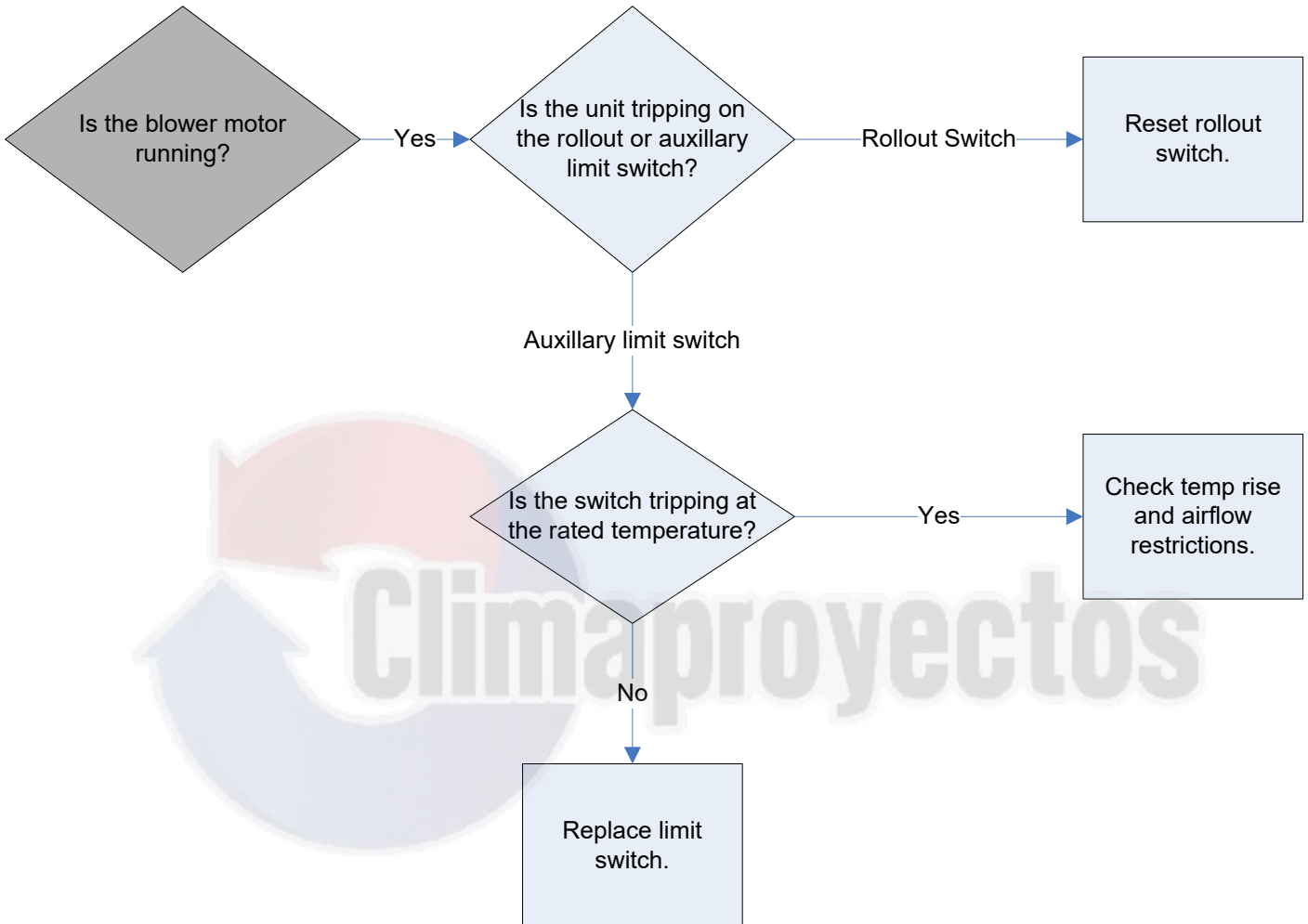

SERVICING

ULN ONLY

LED Flashing – 7 Red

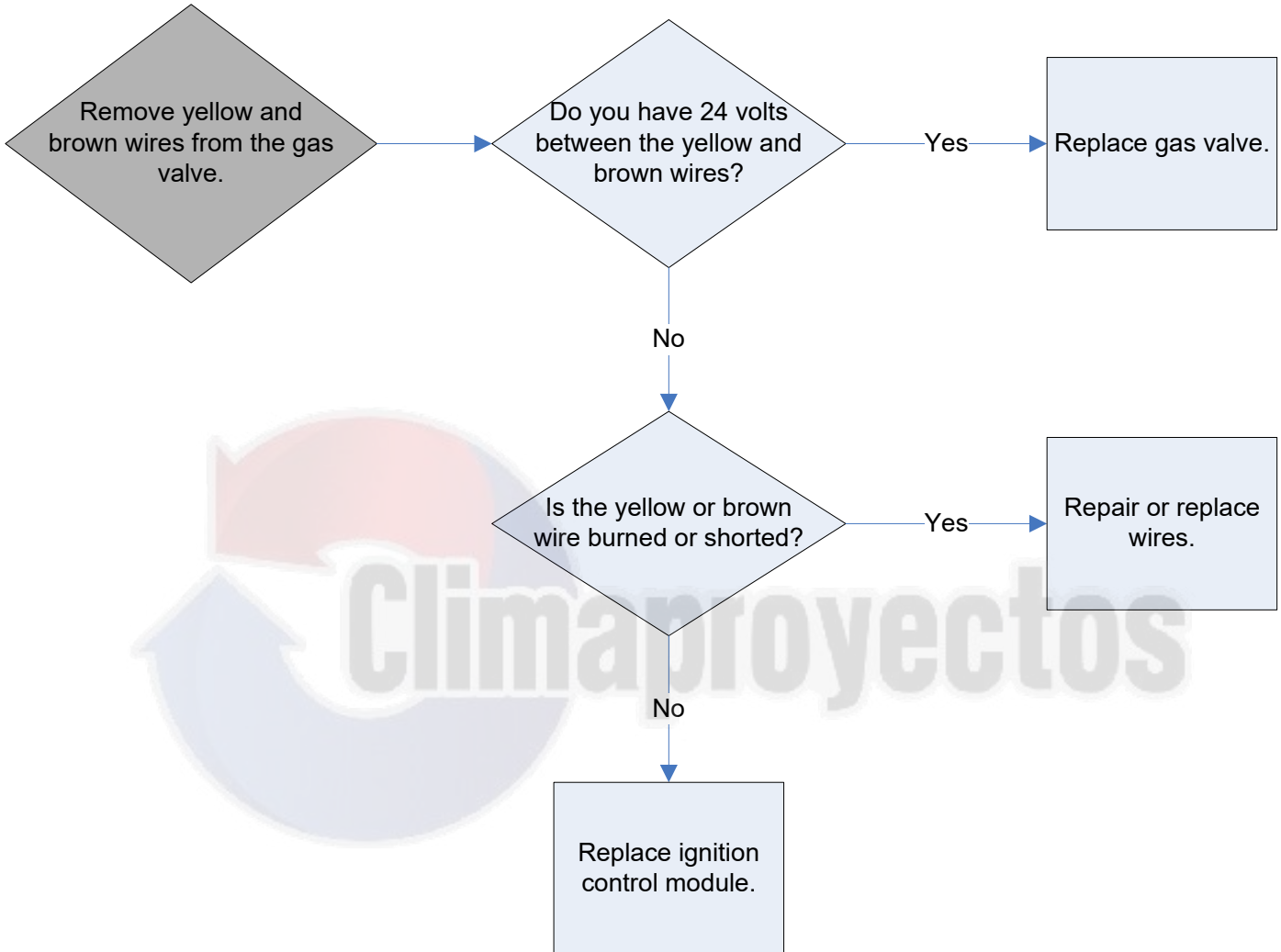

LED Flashing – 10 Red

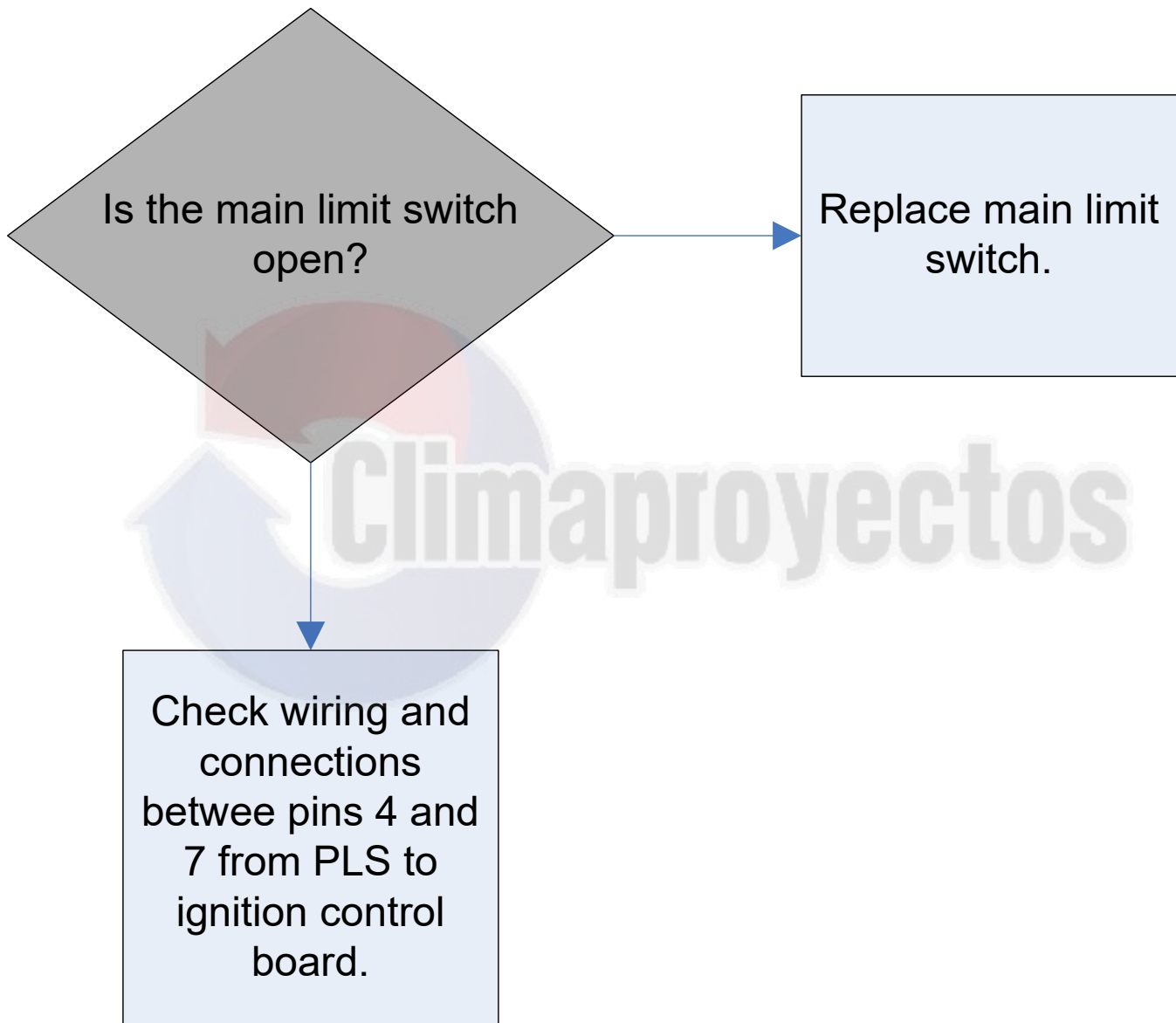

SERVICING

ULN ONLY

LED Flashing – 1 Amber

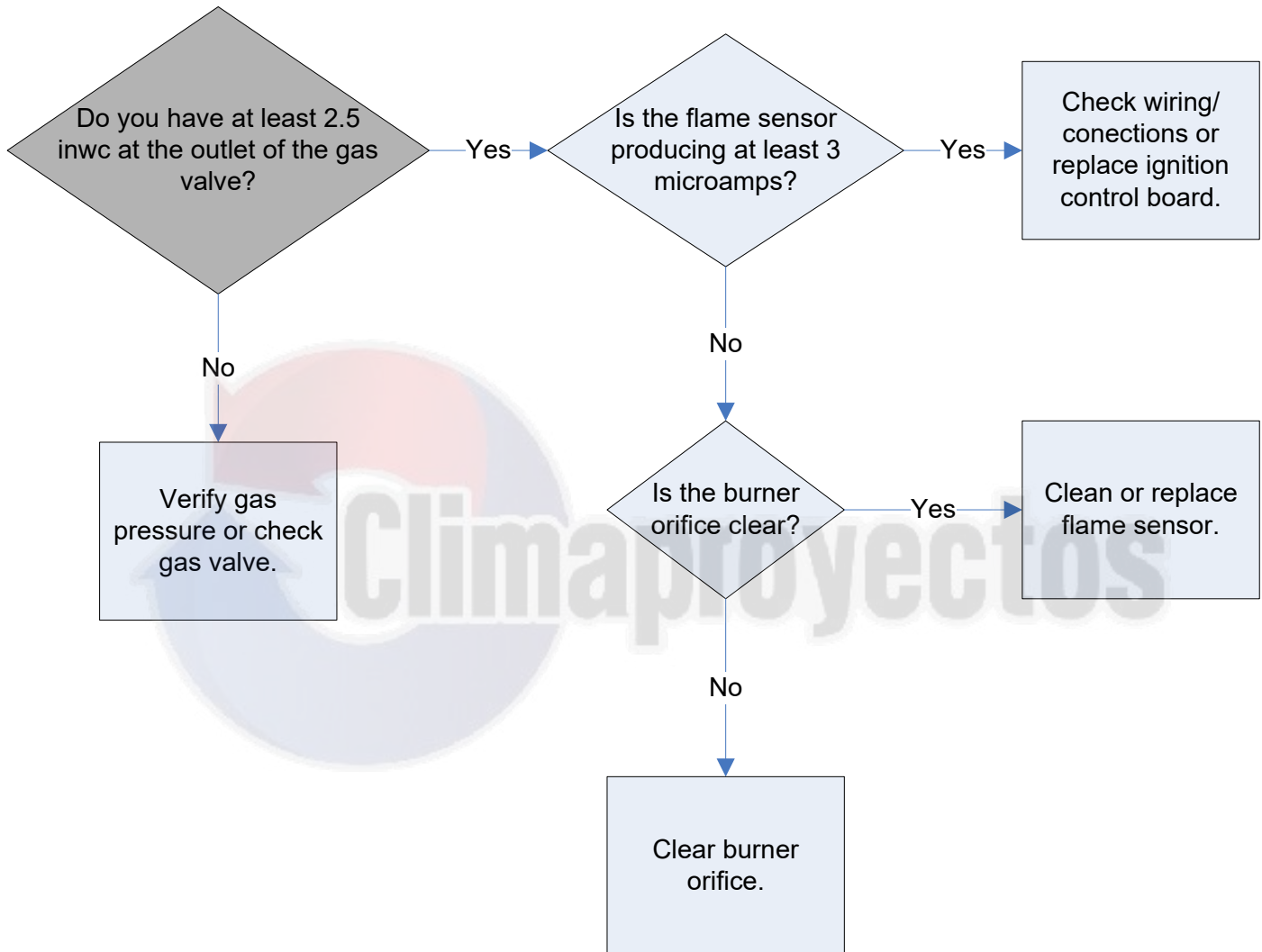

SERVICING

ULN ONLY

LED Flashing – 3 Amber

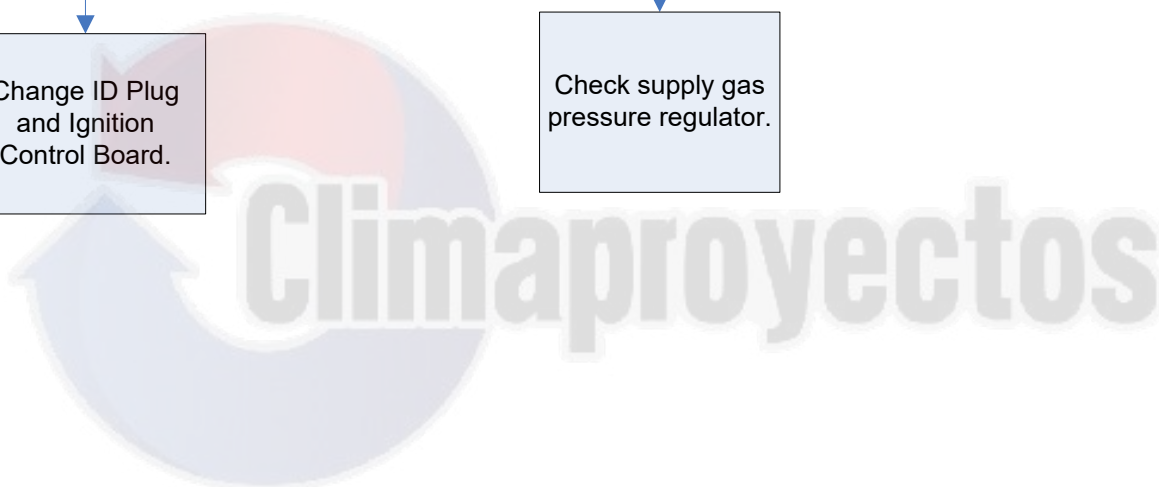
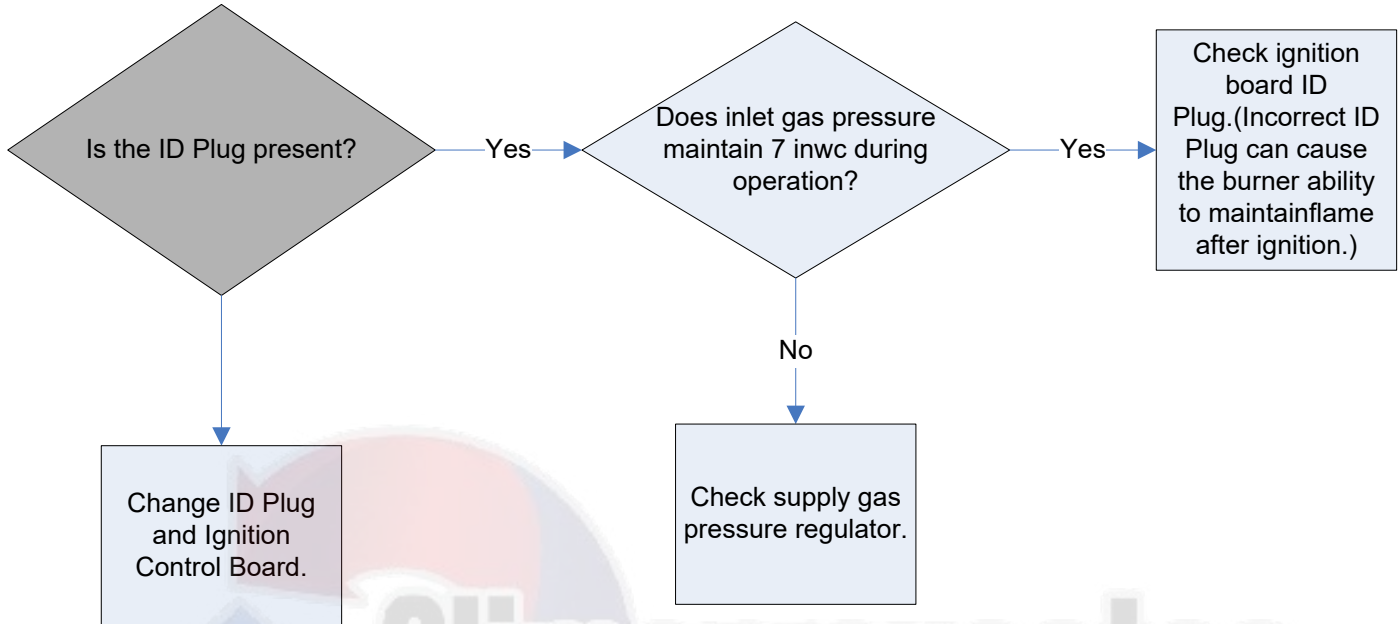

SERVICING

GAS HEAT SERVICING TABLE OF CONTENTS

S-201 CHECKING TEMPERATURE RISE	61
S-300 TESTING PRIMARY LIMIT CONTROL	61
S-301 TESTING AUXILIARY LIMIT	61
S-302 CHECKING FLAME ROLLOUT SWITCH.....	62
S-303 ULN BURNER LIMIT SWITCH	63
S-304 TESTING GAS VALVE.....	64
S-305 CHECKING MAIN BURNERS.....	64
S-306 CHECKING ORIFICES.....	65
S-307 CHECKING GAS PRESSURE	65
S-308 CHECKING FOR DELAYED IGNITION.....	66
S-308B CHECKING FOR DELAYED IGNITION.....	67
S-309 CHECKING FOR FLASHBACK	67
S-310 CHECKING PRESSURE CONTROL	67
S-311 HIGH ALTITUDE APPLICATION	68
S-313 TESTING IGNITION CONTROL MODULE.....	68
S-314 CHECKING FLAME SENSOR	72



SERVICING

S-201 CHECKING TEMPERATURE RISE

Temperature rise is related to the BTUH output of the unit and the amount of air (CFM) circulated over the heat exchanger.

All units are designed for a given range of temperature increase. This is the temperature of the air leaving the unit minus the temperature of the air entering the unit.

The more air (CFM) being delivered through a given unit the less the rise will be; so the less air (CFM) being delivered, the greater the rise. The temperature rise should be adjusted in accordance to a given unit specifications and its external static pressure.

1. Check BTUH input to unit do not exceed input rating stamped on rating plate.
2. Take entering and leaving air temperatures.
3. Select the proper speed tap or dip switch setting for direct drive units.
4. For gas heat units, the airflow must be adjusted so that the air temperature rise falls within the ranges given stated on Data Plate by adjusting the variable pitch sheave on the motor (see Blower Performance section in appropriate Specifications Sheet Manual for correct pulley adjustment).
5. Take motor amperage draw to determine that the motor is not overloaded during adjustments.

S-300 TESTING PRIMARY LIMIT CONTROL

DCG units use a snap-disk type primary limit device. Sometimes referred to as “stat on a stick”. The limit setting is fixed and must not be readjusted in the field.

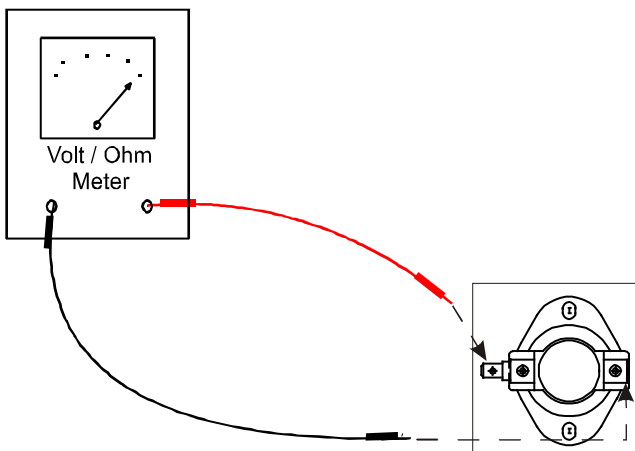

TESTING PRIMARY LIMIT CONTROL

Refer to the specification section to determine the proper limit cutout temperature for the model being serviced.

In all instances the limit control is wired in series with the ignition control.

If the temperature within the furnace should exceed this setting, the control will open, de-energizing the ignition control which in turn will open the electrical circuit to the gas valve.

The control will automatically reset when the temperature within the combustion chamber is sufficiently lowered.

⚠ WARNING

HIGH VOLTAGE!
Disconnect ALL power before servicing or installing this unit. Multiple power sources may be present. Failure to do so may cause property damage, personal injury or death.



1. Remove electrical power to unit. Some units may have more than one source of power.
2. Remove the wires from the limit control terminals.
3. Using an ohmmeter, test for continuity across the two terminals.
4. If limit test open allow unit to cool and retest.
5. If still open, replace the control.

S-301 TESTING AUXILIARY LIMIT

The auxiliary limit control is a preset nonadjustable control mounted in the blower compartment area.

It is connected in series with the rollout switch wiring to the gas valve. If its temperature should be exceeded, it will open, interrupting the voltage to the gas valve causing it to open.

An additional limit (primary limit) control is required for safety control of high temperature within the furnace or ductwork.

SERVICING

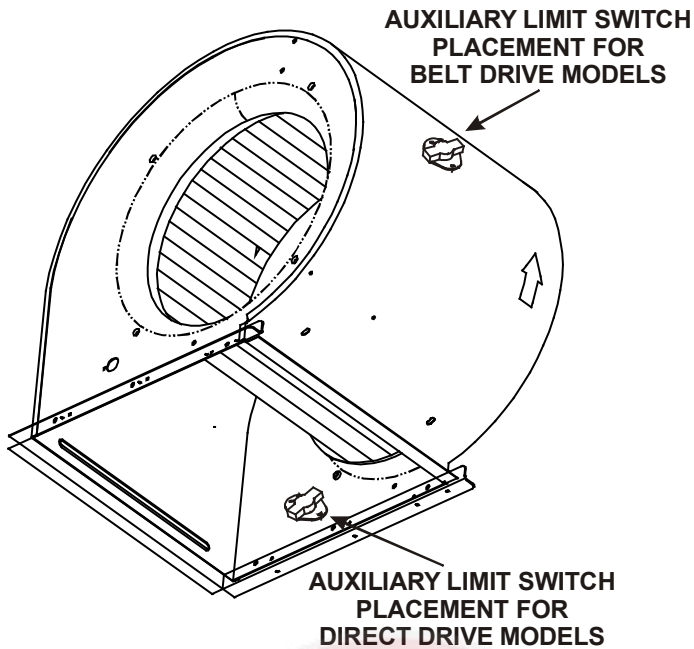

S-302 CHECKING FLAME ROLLOUT SWITCH

DCG units are equipped with a temperature-activated manual reset control. This control is mounted to the manifold assembly and is wired in series with the auxiliary limit and gas valve. The control is designed to open should a flame roll out occur. An over firing condition or flame impingement on the heat shield can also cause the control to open.

If the rollout control has opened, the circuit between the ignition control and gas valve will be interrupted and the ignition control module will go into lockout. The servicer should reset the ignition control by opening and closing the thermostat circuit. The servicer should look for the ignitor glowing which indicates there is power to the ignition control. The servicer should measure the voltage between each side of the rollout control and ground while the ignition control is try to power the gas valve.

⚠ WARNING

HIGH VOLTAGE!
Disconnect ALL power before servicing or installing this unit. Multiple power sources may be present. Failure to do so may cause property damage, personal injury or death.

1. Remove the wires from the auxiliary limit control terminals.
2. Using an ohmmeter, test for continuity across the two terminals. No reading indicates the control is open. Push the red reset button, test again - if still open, replace the control.
3. If limit tests open, allow unit to cool and retest.
4. If still open, replace the control.

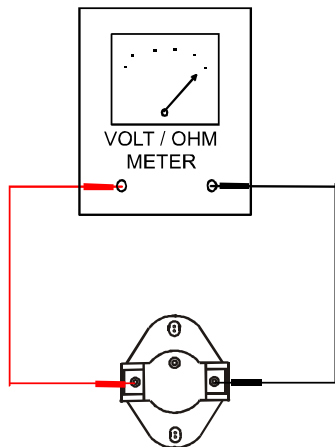

TESTING AUXILIARY LIMIT CONTROL

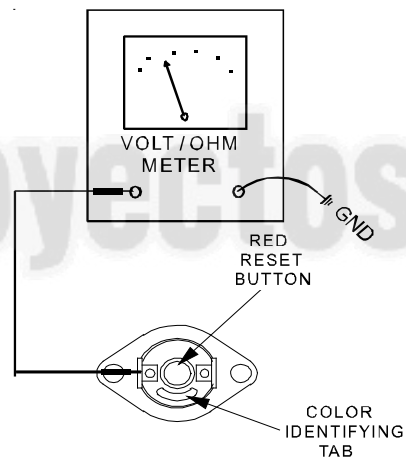

CHECKING FLAME ROLLOUT SWITCH

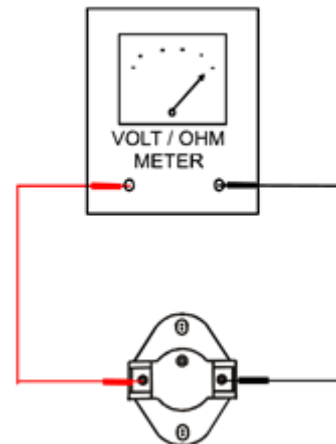

TESTING BURNER LIMIT CONTROL

SERVICING

LIMIT SWITCH OPERATION (APPLIES TO PRIMARY, AUXILIARY, AND ROLL OUT LIMITS) DSI SYSTEMS.

If a limit switch opens, the indoor blower is energized on heat speed and the induced draft blower is energized. The LED on the control flashes "4" to indicate an open limit switch. The blower and inducer remain on while the limit switch is open. The gas valve is de-energized. Power to the thermostat "R" is removed while the limit switch is open.

When the limit switch re-closes, the induced draft motor runs through its post purge and the indoor blower goes through the heat off delay.

If a call for heat exists when the limit switch re-closes, the control goes through a pre-purge period and then makes an ignition attempt. The indoor blower remains on (for the delay off time) during the re-ignition attempt.

1. If no voltage is measured on either side of control it indicates ignition control or wiring to control problem.
2. If voltage is measured on one side of the control and not the other, it indicates the control is open.
3. If voltage is measured on both sides of the control the wiring to gas valve or valve is at fault.

SERVICING PROCEDURE WITH FURNACE NOT FIRING.

4. Confirm that the outer door was in place and all screws tightened. (No leaks under the door.)
5. Check to see if any damage was done to the furnace especially the wiring.
6. Confirm that heat exchanger is not obstructed by feeling for discharge air from the flue hood when the combustion blower is running but the unit is not firing.

If the above steps do not suggest the reason the control has tripped the furnace should be fired.

1. Remove the heating compartment door.
2. Turn off the power or open the thermostat circuit.
3. Reset the rollout control.
4. Turn power on and put the unit into a call for heating.



CAUTION

Flame rollout could occur. Keep face and hands a safe distance from burner area.

5. Look under the heat shield as the unit is running. Flames should be drawn into firing tubes.

- A. If only one burner's flame is not drawn into the tube, that tube is restricted.
- B. If, without the air circulation blower running, all flames are not drawn into the tubes either the collector box, combustion blower, or flue outlet is obstructed. If the combustion blower or flue outlet is obstructed, the pressure switch should have opened preventing the unit from firing, also inspect the unit pressure switch and wiring.
- C. If the burner flame is not drawn into the tube only when the air circulation blower is running, then a cracked heat exchanger tube is present.

S-303 TESTING BURNER LIMIT (ULN ONLY)

ULN units are equipped with a temperature-activated automatic reset limit. This limit is mounted to the Burner assembly and is wired in series with the auxiliary limit and gas valve. It is designed to open should the air inlet to burner get obstructed.

If the Burner limit has opened, the circuit between the ignition control and gas valve will be interrupted and the ignition control module will go into lockout. The servicer should reset the ignition control by opening and closing the thermostat circuit.

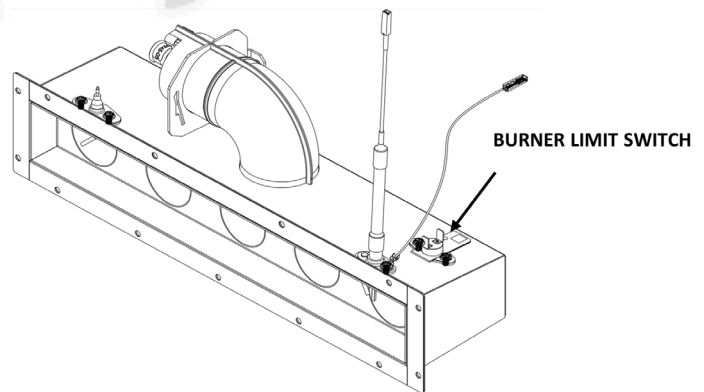

SERVICING

WARNING

HIGH VOLTAGE
DISCONNECT ALL POWER BEFORE SERVICING OR INSTALLING THIS UNIT. MULTIPLE POWER SOURCES MAY BE PRESENT. FAILURE TO DO SO MAY CAUSE PROPERTY DAMAGE, PERSONAL INJURY OR DEATH.



1. Remove the wires from the burner limit control terminals.
2. Using an ohmmeter, test for continuity across the two terminals. No reading indicates the control is open.
3. If limit tests open, allow unit to cool and retest.
4. If still open, replace the control.

S-304 TESTING GAS VALVE

DIRECT SPARK IGNITION (DSI) SYSTEMS

TWO STAGE MODELS ONLY: A two-stage combination redundant operator type gas valve which provides all manual and automatic control functions required for gas fired heating equipment is used.

The valve provides control of main burner gas flow, pressure regulation, and 100 percent safety shut-off.

WARNING

HIGH VOLTAGE!
Disconnect ALL power before servicing or installing this unit. Multiple power sources may be present. Failure to do so may cause property damage, personal injury or death.



1. Ensure gas valve and main gas supply are on.
2. Using a voltmeter, check from C and M on gas valve for 24 volts to gas valve.
3. If 24 volts are present and no gas flows through the valve, replace valve.

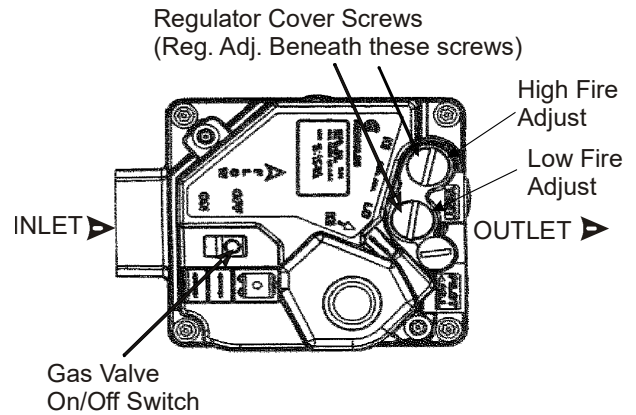

WHITE-RODGERS 36H54 PRESSURE ADJUSTMENTS

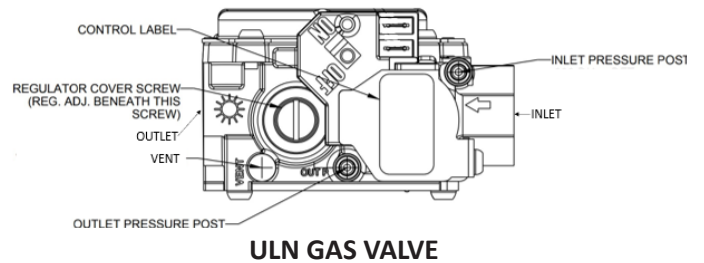

ULN GAS VALVE

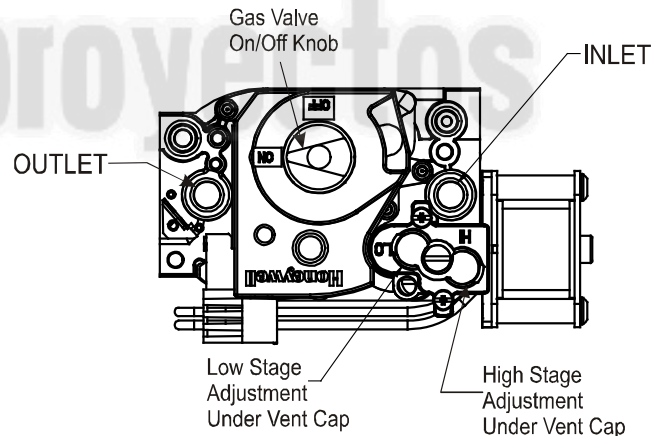

HONEYWELL 0151M00015 PRESSURE ADJUSTMENTS

S-305 CHECKING MAIN BURNERS

The main burners are used to provide complete combustion of various fuels in a limited space, and transfer this heat of the burning process to the heat exchanger.

Proper ignition, combustion, and extinction are primarily due to burner design, orifice sizing, gas pressure, primary and secondary air, vent and proper seating of burners.

SERVICING

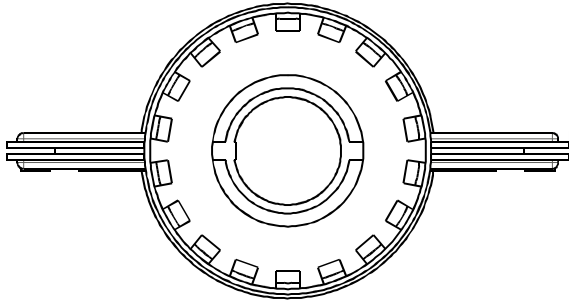

BECKETT BURNER

WARNING
Disconnect gas and electrical power supply.

In checking main burners, look for signs of rust, oversized and undersized carry-over ports restricted with foreign material, etc.

S-306 CHECKING ORIFICES

A predetermined fixed gas orifice is used in all of these furnaces. That is an orifice which has a fixed bore and position.

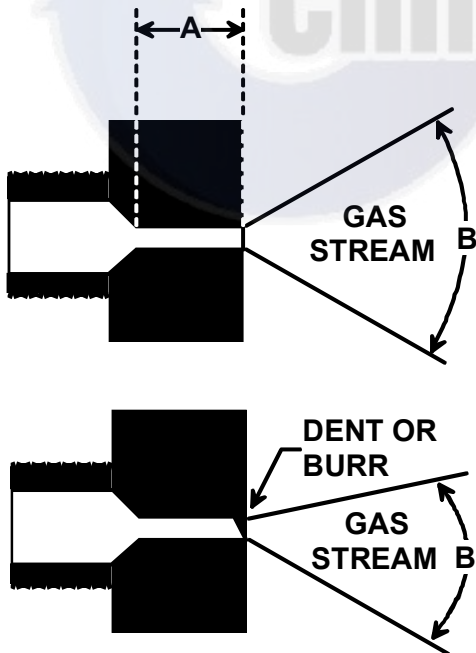

The length of Dimension "A" determines the angle of Gas Stream Defraction, "B".

A dent or burr will cause severe deflection of gas stream.

No resizing should be attempted until all factors are taken into consideration such as inlet manifold gas pressure, alignment, and positioning, specific gravity and BTU content of the gas being consumed.

The only time resizing is required is when a reduction in firing rate is required for an increase in altitude.

Orifices should be treated with care in order to prevent damage. They should be removed and installed with a box-end wrench in order to prevent distortion. In no instance should an orifice be peened over and redrilled. This will change the angle or deflection of the vacuum effect or entraining of primary air, which will make it difficult to adjust the flame properly. This same problem can occur if an orifice spud of a different length is substituted.

WARNING
Disconnect gas and electrical power supply.

1. Check orifice visually for distortion and/or burrs.
2. Check orifice size with orifice sizing drills.
3. If resizing is required, a new orifice of the same physical size and angle with proper drill size opening should be installed.

S-307 CHECKING GAS PRESSURE

Gas inlet and manifold pressures should be checked and adjusted in accordance to the type of fuel being consumed.

WARNING
Disconnect gas and electrical power supply.

1. Connect a water manometer or adequate gauge to the inlet pressure fitting of the gas valve.
2. Remove the pressure tap fitting at the manifold if provided or check at the gas valve outlet fitting and connect another manometer or gauge.

SERVICING

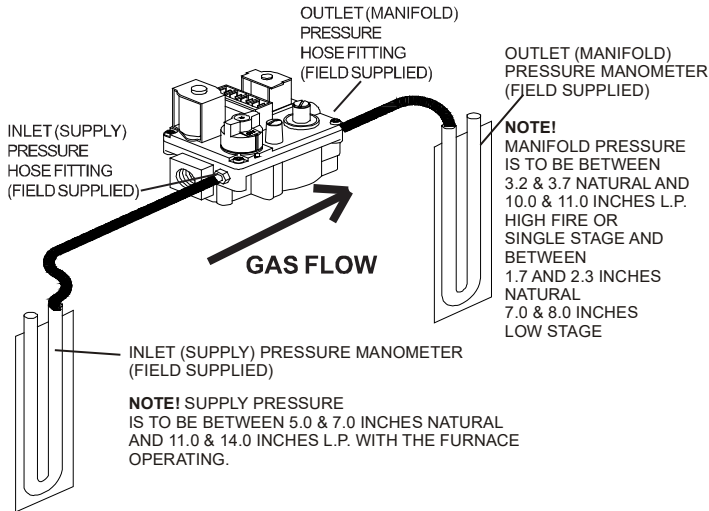

TWO-STAGE H VALVE MEASURING INLET AND MANIFOLD GAS PRESSURE

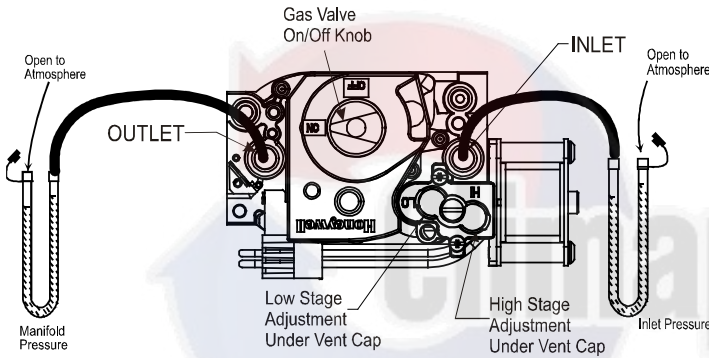

HONEYWELL 2 STAGE GAS VALVE

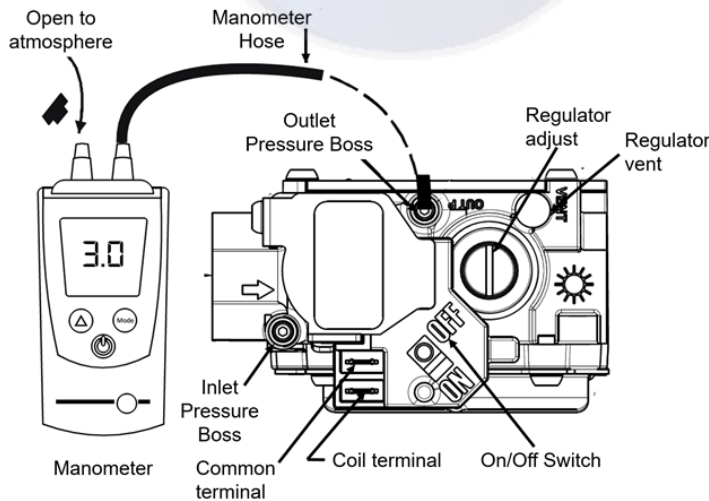

ULN 2 STAGE GAS VALVE

With Power ON:

⚠ WARNING
Line Voltage now present.

- Put unit into heating cycle and turn on all other gas consuming appliances.

For NATURAL GAS:

- Inlet pressure should be a nominal 7" w.c.
- (2 stage heat models only) Manifold pressure on low stage should be 2.0" w.c. \pm 3" w.c.
- Manifold pressure for single stage heat models and 2 stage heat models on high stage should be 3.5" \pm .3" w.c.

For PROPANE GAS:

- Inlet pressure should be a nominal 11" w.c.
- (2 stage heat models only) Manifold pressure for 2 stage heating models on low stage should be 6" w.c.
- Manifold pressure for single stage heat models and 2 stage heat models on high stage should be 10" w.c.

For ULN:

MANIFOLD GAS PRESSURE 2 Stage Heat Models			
	Gas	Range	Nominal
Natural	Low Stage	1.6 - 2.2" w.c.	2.0" w.c.
	High Stage	3.2 - 3.8" w.c.	3.5" w.c.
Propane	Low Stage	5.7 - 6.3" w.c.	6.0" w.c.
	High Stage	9.7 - 10.3" w.c.	10.0" w.c.
ULN	Natural	2.7 - 3.3" w.c.	3.0" w.c.

If operating pressures differ from chart, make necessary pressure regulator adjustments, check piping size, etc., and/or consult with local utility.

S-308 CHECKING FOR DELAYED IGNITION

Delayed ignition is a delay in lighting a combustible mixture of gas and air which has accumulated in the combustion chamber.

When the mixture does ignite, it may explode and/or rollout causing burning in the burner venturi.

If delayed ignition should occur, the following should be checked:

- Improper gas pressure - adjust to proper pressure. (See S-307)
- Improper burner positioning - burners should be in locating slots, level front to rear and left to right.
- Carry over (lighter tube or cross lighter) obstructed - clean.
- Main burner orifice(s) deformed, or out of alignment to burner - replace.

SERVICING

S-308B CHECKING FOR DELAYED IGNITION (ULN ONLY)

Delayed ignition is a delay in lighting a combustible mixture of gas and air which has accumulated in the combustion chamber. When the mixture does ignite, it may cause hard ignition in the burner causing a loud sound.

If delayed ignition should occur, the following should be checked:

1. Improper gas pressure - adjust to proper pressure. (See S-307)
2. Improper ignitor grounding or deposits on the ignitor leads – Ensure the ground wire is firmly connected to the ignitor. Also ensure there are no white deposits anywhere near the spark gap.
3. Change the ignitor if the above troubleshooting doesn't help.

S-309 CHECKING FOR FLASHBACK

Flashback will also cause burning in the burner venturi, but is caused by the burning speed being greater than the gas-air flow velocity coming from a burner port.

Flashback may occur at the moment of ignition, after a burner heats up or when the burner turns off. The latter is known as extinction pop.

Since the end results of flashback and delayed ignition can be the same (burning in the burner venturi) a definite attempt should be made to determine which has occurred.

If flashback should occur, check for the following:

1. Improper gas pressure - adjust to proper pressure. See S-307.
2. Check burner for proper alignment and/or replace burner.
3. Improper orifice size - check orifice for obstruction.

S-310 CHECKING PRESSURE CONTROL

A pressure control device is used to measure negative pressure at the induced draft blower motor inlet to detect a partial or blocked flue.

PRESSURE SWITCH OPERATION (DSI DIRECT SPARK SYSTEM)

The pressure switch is ignored unless there is a call for heat. When the control receives a call for heat, the control checks to see that the pressure switch is open. If the control sees that the pressure switch is closed before the

induced draft blower is energized, the LED will flash a code of "2" (to indicate the pressure switch is stuck closed) and the inducer will remain off until the pressure switch opens. If the pressure switch opens before the ignition period, the induced draft blower will remain on and the control will stay in pre-purge until the pressure switch is closed for an entire 15 second pre-purge period. The LED will flash a code of "3" to indicate open pressure switch.

If the pressure switch opens after the gas valve has been energized, the control will de-energize the gas valve and run the indoor blower through the heat off delay. The inducer stays on until the pressure switch re-closes. Then the control makes another ignition attempt.

! WARNING

HIGH VOLTAGE!
Disconnect ALL power before servicing or installing this unit. Multiple power sources may be present. Failure to do so may cause property damage, personal injury or death.



1. Remove wires from the electrical terminals.
2. Using a VOM check from Common to NO (Normally Open) - should read open.

If switch reads as noted proceed to Step 3, otherwise replace control.

3. Remove the pressure control hose from the control and interconnect with an inclined manometer as shown:

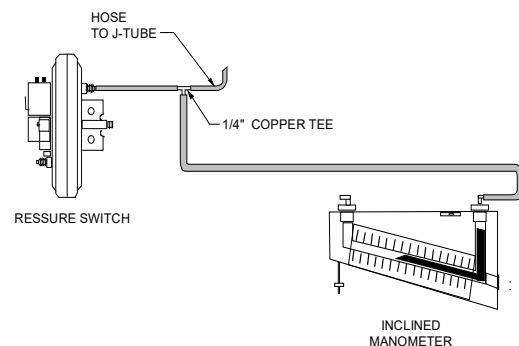

Reconnect wires to the Common and NO terminals.

With Power ON:

! WARNING

Line Voltage now present.

SERVICING

4. Energize furnace for heating cycle. The induced draft blower motor will begin to run. The inclined manometer should read approximately $-1.2'' \pm 0.3''$ W.C with no combustion.
5. Remove and check the two electrical wires and using the VOM check from Common to NO (Normally Open), it should read closed (with I.D. motor running). If not as above, replace pressure control.
6. Reconnect all wires to the control and place in heating cycle.
7. As the unit fires on high stage, the inclined manometer negative pressure will drop to $-0.9'' \pm 0.3''$ W.C.
8. If not as listed, replace control.

NOTE: The pressure switch must be mounted with the diaphragm in a vertical position.

S-311 HIGH ALTITUDE APPLICATION

IMPORTANT NOTE: The gas/electric units naturally derate with altitude. Do not attempt to increase the firing rate by changing orifices or increasing the manifold pressure. This can cause poor combustion and equipment failure. At all altitudes, the manifold pressure must be within 0.3 inches W.C. of that listed on the nameplate for the fuel used. At all altitudes and with either fuel, the air temperature rise must be within the range listed on the unit nameplate. Refer to the Installation Manual provided with the LP kit for conversion from natural gas to propane gas and for altitude adjustments.

When this package unit is installed at high altitude, the appropriate High Altitude orifice kit must be installed. As altitude increases, there is a natural reduction in the density of both the gas fuel and combustion air. This kit will provide the proper design certified input rate within the specified altitude range. High altitude kits are not approved for use in Canada. For installations above 2,000 feet, use kit HAKT36300. The HAKT36300 kit is used for both Natural and LP gas at high altitudes.

Use LPKT180300A propane conversion kit for propane conversions at altitudes below 2000 feet. Natural gas installations below 2000 feet do not require a kit.

For propane conversions above 2000 feet, high altitude kit HAKT36300 is required in addition to LPKT180300A propane conversion kit.

NATURAL GAS AND LP GAS INSTALLATIONS AT ALTITUDES > 2000 FT.

INPUT/BURNER	HIGH ALTITUDE KIT	35,000 BTUH NAT/33,000 BTUH/L.P.							
		ELEVATION ABOVE SEA-LEVEL (FEET)							
		2000	3000	4000	4500	5000	6000	7000	8000
U.S. BURNER ORIFICE	HAKT36300	35/53	36/53	36/53	-	37/53	37/53	38/53	39/54
CANADA BURNER ORIFICE	HAKT36300	35/53	-	-	39/54	-	-	-	-

INPUT/BURNER	HIGH ALTITUDE KIT	50,000 BTUH NAT/45,000 BTUH/L.P.							
		ELEVATION ABOVE SEA-LEVEL (FEET)							
		2000	3000	4000	4500	5000	6000	7000	8000
U.S. BURNER ORIFICE	HAKT36300	29/48	30/48	30/49	-	30/49	30/49	31/50	31/50
CANADA BURNER ORIFICE	HAKT36300	29/48	-	-	31/50	-	-	-	-

Use HAUL100 (for 100,000 BTU/h models) and HAUL6080 (for 60,000 and 80,000 BTU/h models) high altitude kits for ULN model installations above 4500 ft. Manifold pressure adjustments and ID Plug changes are required as per IO supplied in the kit.

S-313 TESTING IGNITION CONTROL MODULE

NOTE: Failure to earth ground the unit, reversing the neutral and hot wire connection to the line (polarity), or a high resistance connection in the ground or neutral lines may cause the control to lockout due to failure to detect flame.

⚠ WARNING

HIGH VOLTAGE
 Wiring to this unit must be properly polarized and grounded. Disconnect ALL power before installing or servicing this unit. Multiple power sources may be present.



The ground wire must run from the unit all the way back to the electrical panel. Proper grounding can be confirmed by disconnecting the electrical power and measuring resistance between the neutral (white) connection and the burner closest to the flame sensor. Resistance should be less than 10 ohms.

DSI DIRECT SPARK IGNITION SYSTEMS

NORMAL SEQUENCE OF OPERATION (DSI DIRECT SPARK IGNITION SYSTEM)

1. Thermostat calls for heat by energizing "W". The control checks the pressure switch for open condition. If the pressure switch is closed the control will flash code "3" and wait for the pressure switch to open.
2. The induced draft motor is energized and the control flashes code "2" and waits for the pressure switch to close. Once the pressure switch is closed, the LED stops flashing and the control begins timing the 15 second pre-purge.

SERVICING

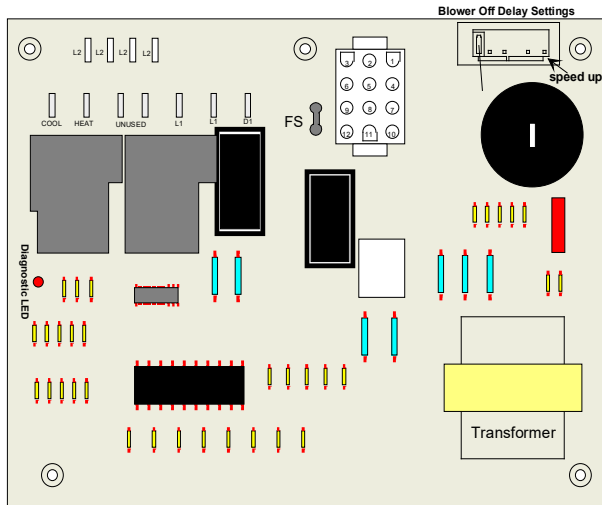

DSI CONTROL BOARD

3. The control energizes the spark igniter and gas valve for 7 seconds. If flame is established, the control goes into a 30 second heat on delay.
4. The indoor blower is energized at the heat speed after a 30 second on delay.
5. The control monitors the safety circuit inputs, flame, and thermostat during operation.
6. When the thermostat is satisfied, the gas valve is de-energized and the induced draft blower remains on for a 29 second post purge. The indoor blower remains on for the selected heat blower off delay (90, 120, or 150 seconds). Indoor blower off timing begins when thermostat call for heat ends.

TESTING DIRECT SPARK IGNITION (DSI) SYSTEMS

Thermostat calling for heat (15 second prepurge time and 7 second trial for ignition).

1. Check for 230 VAC from L1 terminal of control module to L2. No voltage - check wire connections, continuity, etc.
2. Check for 24 VAC at "R" to "C" thermostat terminals.
 - A. No voltage - check 3 amp automotive type fuse on control board. A blown fuse would indicate a short in the 24 VAC circuit (thermostat or limit circuit).
 - B. Voltage Present - check limit, auxiliary limit and rollout (S-300, S-301 and S-302). If limit, auxiliary limit and rollout are closed, then check for 24 VAC at the gas valve terminals.
 - C. No 24 VAC at gas valve - replace Control board.

TROUBLESHOOTING

IGNITION CONTROL ERROR CODES

The following presents probable causes of questionable unit operation. Refer to *Diagnostic Indicator Chart* for an interpretation of the signal and to this section for an explanation.

Remove the control box access panel and note the number of diagnostic LED flashes. Refer to *Diagnostic Indicator Chart* for an interpretation of the signal and to this section for an explanation.

INTERNAL CONTROL FAILURE

If the integrated ignition control in this unit encounters an internal fault, it will go into a "hard" lockout and turn off the diagnostic LED. If diagnostic LED indicates an internal fault, check power supply to unit for proper voltage, check all fuses, circuit breakers and wiring. Disconnect electric power for five seconds. If LED remains off after restoring power, replace control.

ABNORMAL OPERATION - HEATING CODES

EXTERNAL LOCKOUT (1 FLASH CODE)

An external lockout occurs if the integrated ignition control determines that a measurable combustion cannot be established within three (3) consecutive ignition attempts.

If flame is not established within the seven (7) second trial for ignition, the gas valve is deenergized, 15 second inter-purge cycle is completed, and ignition is reattempted. The control will repeat this routine three times if a measurable combustion is not established. The control will then shut off the induced draft blower and go into a lockout state.

If flame is established but lost, the control will energize the circulator blower at the heat speed and then begin a new ignition sequence. If flame is established then lost on subsequent attempts, the control will recycle for four (4) consecutive ignition attempts (five attempts total) before locking out.

SERVICING

The diagnostic fault code is 1 flash for a lockout due to failed ignition attempts or flame dropouts. The integrated control will automatically reset after one hour, or it can be reset by removing the thermostat signal or disconnecting the electrical power supply for over five seconds. If the diagnostic LED indicates an external lockout, perform the following checks:

- *Check the supply and manifold pressures*
- *Check the gas orifices for debris*
- *Check gas valve for proper operation*
- *Check secondary limit*

A dirty filter, excessive duct static, insufficient air flow, a faulty limit, or a failed circulator blower can cause this limit to open. Check filters, total external duct static, circulator blower motor, blower motor speed tap (see wiring diagram), and limit. An interruption in electrical power during a heating cycle may also cause the auxiliary limit to open. The automatic reset secondary limit is located on top of the circulator blower assembly.

- *Check rollout limit*

If the burner flames are not properly drawn into the heat exchanger, the flame rollout protection device will open. Possible causes are restricted or blocked flue passages, blocked or cracked heat exchanger, a failed induced draft blower, or insufficient combustion air. The rollout protection device is a manual reset limit located on the burner bracket. The cause of the flame rollout must be determined and corrected before resetting the limit.

- *Check flame sensor*

A drop in flame signal can be caused by nearly invisible coating on the sensor. Remove the sensor and carefully clean with steel wool.

- *Check wiring*

Check wiring for opens/shorts and miswiring.

IMPORTANT: If you have to frequently reset your gas/electric package unit, it means that a problem exists that should be corrected. Contact a qualified servicer for further information.

PRESSURE SWITCH STUCK OPEN (2 FLASH CODE)

A pressure switch stuck open can be caused by a faulty pressure switch, faulty wiring, a disconnected or damaged hose, a blocked or restricted flue, or a faulty induced draft blower.

If the control senses an open pressure switch during the pre-purge cycle, the induced draft blower only will be energized. If the pressure switch opens after ignition has begun the gas valve is deenergized, the circulator

blower heat off cycle begins, and the induced draft blower remains on. The diagnostic fault code is two flashes.

PRESSURE SWITCH STUCK CLOSED (3 FLASH CODE)

A stuck closed pressure switch can be caused by a faulty pressure switch or faulty wiring. If the control encounters a pressure switch stuck closed, the induced draft blower remains off. The diagnostic LED code for this fault is three (3) flashes.

OPEN THERMAL PROTECTION DEVICE (4 FLASH CODE)

If the primary limit switch opens, the gas valve is immediately deenergized, the induced draft and air circulating blowers are energized. The induced draft and air circulator blowers remain energized until the limit switch recloses. The diagnostic fault code for an open limit is four (4) flashes.

A primary limit will open due to excessive supply air temperatures. This can be caused by a dirty filter, excessive duct static, insufficient air flow, or a faulty limit. Check filters, total external duct static, blower motor, blower motor speed tap (see wiring diagram), and limit. This limit will automatically reset once the temperature falls below a preset level.

FLAME DETECTED WITH GAS VALVE CLOSED (5 FLASH CODE)

If flame is detected with the gas valve deenergized, the combustion and air circulator blowers are energized. The diagnostic fault code is five (5) flashes for this condition. The control can be reset by removing the power supply to the unit or it will automatically reset after one hour. Miswiring is the probable cause for this fault.

ABNORMAL OPERATION - HEATING CODES

RESETTING FROM LOCKOUT (ULN ONLY)

An external lockout occurs if the integrated ignition control determines that a measurable combustion cannot be established within three (3) consecutive ignition attempts. If flame is not established within the four (4) second trial for ignition, the gas valve is de-energized, 30 second inter-purge cycle is completed, and ignition is re-attempted. The control will repeat this routine three times if a measurable combustion is not established. The control will then shut off the induced draft blower and go into a lockout state.

If flame is established but lost, the control will energize the circulator blower at the heat speed and then begin a new ignition sequence. If flame is established then lost on subsequent attempts, the control will recycle the ignition sequence.

SERVICING

The diagnostic fault code is 1 flash for a lockout due to failed ignition attempts. The integrated control will automatically reset after one hour, or it can be reset by removing the thermostat signal or disconnecting the electrical power supply for over five seconds.

Important Note: If you have to frequently reset your gas/electric package unit, it means that a problem exists that should be corrected. Contact a qualified servicer for further information.

PRESSURE SENSOR

The pressure sensor is mounted in the control box and connected to the induced draft blower. Its function is to regulate the induced draft blower's speed in order to maintain proper air-fuel ratio for clean and reliable combustion. The electrical output signal from the sensor is expected to be proportional to the magnitude of the differential pressure between the inducer inlet negative pressure and the ambient air pressure. The pressure sensor also guards against insufficient airflow (combustion air and flue products) through the heat exchanger.

At the beginning of a call for heat, the control ensures the inducer is in an off state, then checks the pressure sensor output for the proper null offset value. If the pressure sensor output is outside the acceptable range for the null value, the control enters a five minute lockout. After the lockout timer has expired, the control resumes normal operation.

During inducer operation, including all operating modes except for the null test, the control monitors the pressure sensor output for expected values. The control limits during normal operation are expected to be within certain tolerances of the target pressures. In response to a pressure sensor span error, the control enters a five minute lockout. After the lockout timer has expired, the control resumes normal operation.

PRIMARY LIMIT

A primary limit will open due to excessive supply air temperatures. This can be caused by a dirty filter, excessive duct static, insufficient air flow, or a faulty limit. Check filters, total external duct static, blower motor, blower motor speed tap (see wiring diagram), and limit. This limit will automatically reset once the temperature falls below a preset level.

If a limit switch opens, the gas valve is immediately de-energized, the induced draft and air circulating blowers are energized. The induced draft and air circulator blowers remain energized for 5 minutes or until the limit switch re-closes, whichever happens first.

NOTE: If the primary limit opens three (3) times within the same call for heat, the ignition control will lock out for one (1) hour with the air circulating blower energized at heating speed.

FLAME DETECTED WITH GAS VALVE CLOSED

If flame is detected with the gas valve de-energized, the combustion and air circulator blowers are energized. The control can be reset by removing the power supply to the unit or it will automatically reset after one hour. Miswiring is the probable cause for this fault. The initial lockout period is 5 minutes. After that time, the control continues to monitor the flame sense input and resumes normal operation when flame is no longer sensed.

LOW FLAME SIGNAL

Under some conditions, the fuel or air supply can create a nearly invisible coating on the flame sensor. This coating acts as an insulator causing a drop in the flame signal. If the flame signal drops below a predetermined value, the ignition control will display an error code of (1) flash on the amber diagnostic LED. The unit will continue to operate until the control can no longer detect flame.

BURNER SWITCH

The burner temperature switch is mounted on the burner assembly to monitor the burner box temperature. It is normally closed (electrically), auto-reset sensor. This switch guards against the burner flames not being properly drawn into the heat exchanger.

The control senses an open blocked burner switch, indicating that the burner temperature/pressure has exceeded its set point. The control de-energizes the gas valve, energizes the inducer to the pre-purge setting and energizes the indoor blower. The initial lockout period is five minutes. After this time elapses, the control evaluates the state of the blocked burner switch. If the switch is closed, the control resumes normal operation. The control will enter a one hour lockout state if the blocked burner switch fails to reset before the recovery timer has expired.

SERVICING

ID PLUG

The control operational parameters are stored in ID Plug which connects on the circuit board. The control requires a valid ID plug present to operate in heating mode. If a valid ID plug is not present the control will not respond to a call for heat. However, the control will respond to thermostat inputs "Y" or "G", operating the appropriate fan output. The cooling delays are ignored in this operating mode. The control puts the burner into hard lockout and will not respond to heating requests until the power is cycled with a valid ID plug installed.

NOTE: Some electronic thermostats also have a built-in compressor short cycle timer that may be longer than the three minute delay given above. If you are using an electronic thermostat and the compressor has not started after three minutes, wait an additional five minutes to allow the thermostat to complete its short cycle delay time.

The status light on the furnace control may be used as a guide to troubleshooting this appliance. Some more useful status light codes are below:

¹ The fault condition must be cleared for 30 seconds before normal operation can resume. A power cycle will also reset any lockout.

ABNORMAL OPERATION - COOLING CODES

SHORT CYCLE COMPRESSOR DELAY (6 FLASH CODE)

The automatic ignition control has a built-in feature that prevents damage to the compressor in short cycling situations. In the event of intermittent power losses or intermittent thermostat operation, the ignition control will delay output to the compressor contactor for three minutes from the time power is restored. (Compressor is off a total of three minutes). The diagnostic LED will flash six (6) times to indicate the compressor contactor output is being delayed.

NOTE: Some electronic thermostats also have a built-in compressor short cycle timer that may be longer than the three minute delay given above. If you are using an electronic thermostat and the compressor has not started after three minutes, wait an additional five minutes to allow the thermostat to complete its short cycle delay time.

NOTE: The flash rate is 0.25 seconds on, 0.25 seconds off, with a 2-second pause between codes.

S-314 CHECKING FLAME SENSOR

A flame sensing device is used in conjunction with the ignition control module to prove combustion. If a microamp signal is not present the control will de-energize the gas valve and "retry" for ignition or lockout.

DSI DIRECT SPARK IGNITION SYSTEMS

⚠ WARNING

HIGH VOLTAGE!
Disconnect ALL power before servicing or installing this unit. Multiple power sources may be present. Failure to do so may cause property damage, personal injury or death.



1. Disconnect the flame sensor wire from terminal FS of the ignition control module.

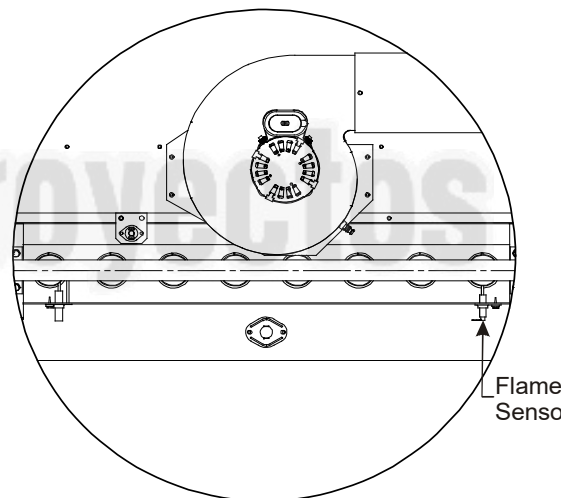

FLAME SENSOR

2. Connect a microamp meter in series with this wire and terminal FS.
3. Be sure the negative side of the meter is to the wire and the positive of the meter is to terminal FS.
4. Turn on Power.

⚠ WARNING

Line Voltage now present.

5. With Power ON, Place the unit into a heating cycle.
6. As soon as flame is established a microamp reading should be evident once proof of flame (microamp reading) is established, the hot surface ignitor will be de-energized.

SERVICING

7. The microamp reading should be 4 - 6 microamps.
8. If the microamp current is less than 0.5 microamp the control will lockout and flash a code of 1 flash after attempting to reestablish flame sense.
9. If the microamp reading is less than the minimum specified, check for high resistance wiring connections, the distance (3/16") between the sensor and burner, flame sensor connections, dirty flame sensor or poor grounding.
10. If no reading, check for continuity on all components and if good - replace ignition control module.

NOTE: Contaminated fuel or combustion air can create a nearly invisible coating on the flame sensor. This coating works as an insulator causing a loss in the flame sense signal. If this situation occurs the flame sensor must be cleaned with steel wool. Do not use sand paper, the silicone in sand paper will further contaminate the sensor.

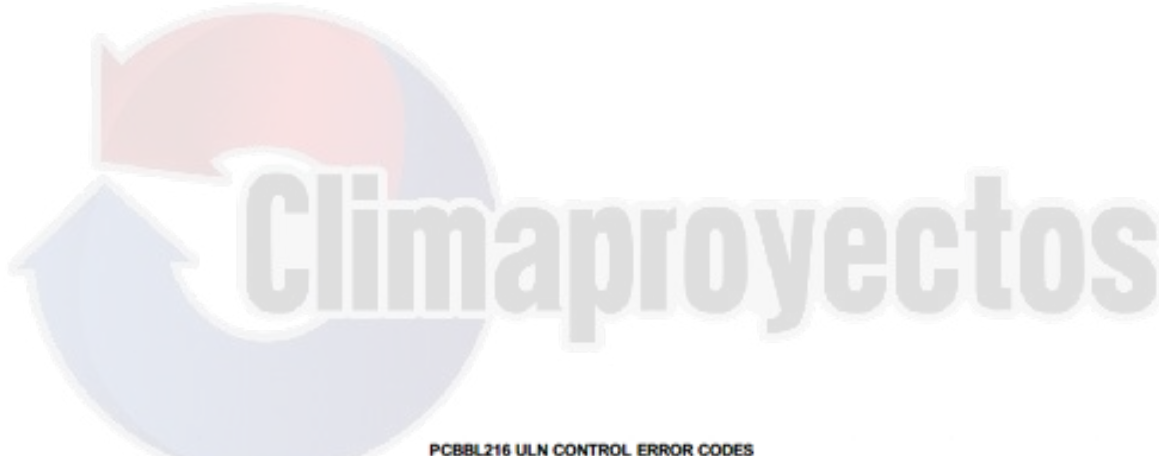

PCBBL216 ULN CONTROL ERROR CODES

LED ACTIVITY	DESCRIPTION	COLOR	MINIMUM LOCKOUT PERIOD ¹	LED ACTIVITY	DESCRIPTION	COLOR	MINIMUM LOCKOUT PERIOD ¹	LED ACTIVITY	DESCRIPTION	COLOR	MINIMUM LOCKOUT PERIOD ¹
LED OFF	NO 24 VAC POWER TO CONTROL	-	N/A	6 FLASHES	NORMALLY CLOSED BLOCKED BURNER SWITCH/AUXILIARY SWITCH OPEN	RED	MAXIMUM RECOVERY PERIOD - 1 HOUR IF TIME EXCEEDED	2 FLASHES	ID PLUG FAILURE	AMBER	HARD LOCKOUT HEATING MODE
RED, AMBER, GREEN	POWER-UP VERIFICATION OF LED	-	N/A	7 FLASHES	GAS VALVE CIRCUIT SHORTED	RED	1 HOUR	3 FLASHES	CONTROL FUSE OPEN	AMBER	5 MINUTES
STEADY ON	CONTROL FAULT DETECTED	RED	1 HOUR OR HARD LOCKOUT	8 FLASHES	RESERVED	RED	-	STEADY ON	STANDBY NORMAL OPERATION NO THERMOSTAT REQUESTS	GREEN	N/A
1 FLASH	RETRIES EXCEEDED	RED	1 HOUR FIXED	10 FLASHES	HIGH LIMIT SWITCH RECOVERY TIMER EXPIRED	RED	1 HOUR OR HARD LOCKOUT	RAPID FLASH	CLEAR ERROR HISTORY	GREEN	N/A
2 FLASHES	PRESSURE SENSOR NULL ERROR	RED	5 MINUTES	STEADY ON	OEM FACTORY TEST MODE	AMBER	N/A	1 FLASH	CALL FOR HEATING	GREEN	N/A
3 FLASHES	PRESSURE SENSOR SPAN ERROR	RED	5 MINUTES	RAPID FLASH	FIELD TEST MODE	AMBER	N/A	2 FLASHES	CALL FOR COOLING	GREEN	N/A
4 FLASHES	HIGH LIMIT SWITCH OPEN	RED	MAXIMUM RECOVERY TIME - 1 HOUR AFTER MAX TRIPS EXCEEDED	1 FLASH	LOW FLAME SENSE	AMBER	N/A	3 FLASHES	CONTINUOUS FAN OPERATION	GREEN	N/A
5 FLASHES	FLAME PRESENT WITH GAS VALVE OFF	RED	5 MINUTES	-	-	-	-	-	-	-	-

ACCESSORIES



ECONOMIZER (JADE)

INTERFACE OVERVIEW

This Section describes how to use the Economizer's user interface for:

- Keypad and menu navigation
- Settings and parameter changes
- Menu structure and selection

USER INTERFACE

The user interface consists of an LCD display and a 4-button keypad on the front of the economizer module. The LCD is a 16 character by 2 line dot matrix display.

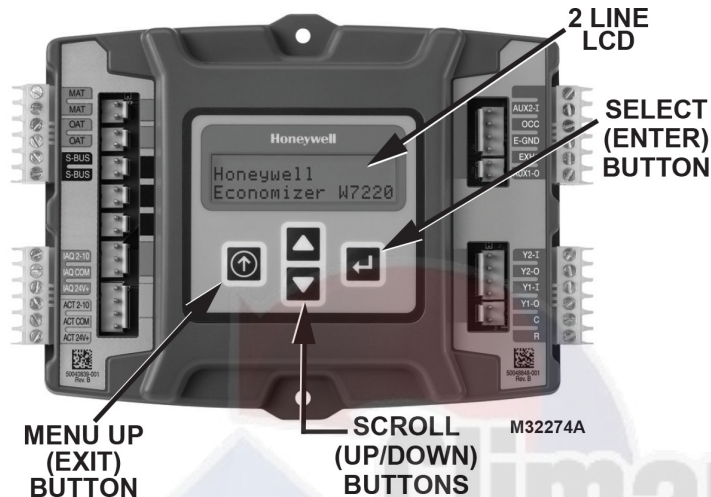

FIGURE 18 - ECONOMIZER LCD AND KEYPAD LAYOUT.

KEYPAD

The four navigation buttons shown in Figure 18 are used to scroll through the menus and menu items, select menu items, and change to parameter and configuration settings.

USING THE KEYPAD WITH MENUS

- To use the keypad when working with menus:
- Press the ▲ button to move to the previous menu.
- Press the ▼ button to move to the next menu.
- Press the ◀ button (Enter) to display the first item in the currently displayed menu.
- Press the ⬆ button (Menu up) to exit a menu's item and return to the list of menus.

USING THE KEYPAD WITH SETTINGS AND PARAMETERS

- To use the keypad when working with Setpoints, System and Advanced Settings, Checkout tests, and Alarms:
- Navigate to the desired menu.
- Press the ◀ Button (Enter) to display the first item in the currently displayed menu.
- Use the ▲ and ▼ buttons to scroll to the desired parameter.
- Press the ◀ button (Enter) to display the value of the currently displayed item.

- Press the ▲ button to increase (change) the displayed parameter value.^a
- Press the ▼ button to decrease (change) the displayed parameter value.^a
- Press the ◀ button to accept the displayed value and stores it in non-volatile RAM.
- CHANGE STORED displays.
- Press the ⬆ button (Menu Up/Exit) to return to the previous menu.

^aWhen values are displayed, pressing and holding the ▲ or ▼ button causes the display to automatically increment.

MENU STRUCTURE

Table 6 illustrates the complete hierarchy of menus and parameters for the JADE™ Economizer system.

The Menus in display order are:

- STATUS
- SETPOINTS
- SYSTEM SETUP
- ADVANCED SETUP
- CHECKOUT
- ALARMS

IMPORTANT

Table 6 illustrates the complete hierarchy.

Your menu parameters will be different depending on your configuration.

For example, if you do not have a DCV (CO₂) sensor then none of the DCV parameters appear and only MIN POS will display.

If you have a CO₂ sensor, the DCV MIN and DCV MAX will appear AND if you have 2-speed fan, DCV MIN (high and low speed) and DCV MAX (high and low speed will appear).

SETUP AND CONFIGURATION

Before placed into service, the JADE™ Economizer module must be setup and configured for the installed system.

IMPORTANT

During setup, the Economizer module is live at all times.

The setup process uses a hierarchical menu structure that is easy to use. You press the ▲ and ▼ arrow buttons to move forward and backward through the menus and press the ◀ button to select and confirm setup item changes.

TIME-OUT AND SCREENSAVER

When no buttons have been pressed for 10 minutes, LCD displays a screen saver, which cycles through the Status items. Each Status items displays in turn and cycles to the next item after 5 seconds.

ECONOMIZER (JADE)

Menu Structure^a.

Menu	Parameter	Parameter Default Value	Parameter Range and Increment ^b	Notes
STATUS	ECON AVAIL	NO	YES/NO	YES = economizing available; the system can use Outdoor Air for free cooling when required.
	ECONOMIZING	NO	YES/NO	YES = Outdoor Air being used for 1 st stage cooling.
	OCCUPIED	NO	YES/NO	YES = OCC signal received from space thermostat or unitary controller. YES = 24 Vac on terminal OCC No = 0 Vac on terminal OCC.
	HEAT PUMP	n/a ^c	COOL HEAT	Displays COOL or HEAT when system is set to heat pump (non-conventional)
	COOL Y1-IN	OFF	ON/OFF	Y1-I signal from space thermostat or unitary controller for cooling stage 1. ON = 24 Vac on term Y1-I OFF = 0 Vac on term Y1-I
	COOL Y1-OUT	OFF	ON/OFF	Cool Stage 1 Relay Output to mechanical cooling (Y1-OUT terminal).
	COOL Y2-IN	OFF	ON/OFF	Y2-I signal from space thermostat or unitary controller for second stage cooling. ON = 24 Vac on term Y2-I OFF = 0 Vac on term Y2-I
	COOL Y2-OUT	OFF	ON/OFF	Cool Stage 2 Relay Output to mechanical cooling (Y2-OUT terminal).
	MA TEMP	___ °F	-40 to 150 °F	Displays value of measured mixed air from MAT sensor. Displays -- if not connected, short, or out-of-range.
	DA TEMP	___ °F	-40 to 150 °F	Displays when Discharge Air Sylk Bus sensor is connected and displays measured discharge air temperature. Displays -- °F if sensor sends invalid value, if not connected, short or out-of-range.
	OA TEMP	___ °F	-40 to 140 °F	Displays measured value of outdoor air temperature. Displays -- °F if sensor sends invalid value, if not connected, short or out-of-range.
	OA HUM	__ %	0 to 100%	Displays measured value of outdoor humidity from OA Sylkbus sensor. Displays --% if not connected, short, or out-of-range.
	RA TEMP	___ °F	0 to 140 °F	Displays measured value of return air temperature from RA Sylkbus sensor. Displays -- °F if sensor sends invalid value, if not connected, short or out-of-range.
	RA HUM	__ %	0 to 100%	Displays measured value of return air humidity from RA Sylkbus sensor. Displays --% if sensor sends invalid value, if not connected, short or out-of-range.
	IN CO2	___ ppm	0 to 2000 ppm	Displays value of measured CO2 from CO2 sensor. Invalid if not connected, short or out-of-range. May be adjusted in Advanced menu by Zero offset and Span. See note on page 6 concerning C7632 sensor.
	DCV STATUS	n/a	ON/OFF	Displays ON if above setpoint and OFF if below setpoint, and ONLY if a CO2 sensor is connected.
	DAMPER OUT	2.0V	2.0 to 10.0 V	Displays output voltage or position to the damper actuator. ^e
	ACT POS	n/a	0 to 100%	Displays actual position of actuator.
	ACT COUNT	n/a	1 to 65,535	Displays number of times actuator has cycled. 1 Cycle equals the sum of 180° of movement in any direction.
	ACTUATOR	n/a	OK/Alarm (on Alarm menu)	Displays Error if voltage or torque is below actuator range
EXH1 OUT	OFF	ON/OFF	Output of EXH1 terminal. Displays ON when damper position reaches programmed percentage setpoint. ON = 24 Vac Output; OFF = No Output.	

ECONOMIZER (JADE)

Menu Structure^a. (Continued)

Menu	Parameter	Parameter Default Value	Parameter Range and Increment ^b	Notes	
STATUS CONTINUED	EXH2 OUT	OFF	ON/OFF	Output of AUX1 0 terminal Displays ON when damper position reaches programmed percentage setpoint ON = 24 Vac Output, OFF = No Output; displays only if AUX1 0 = EXH2	
	ERV	OFF	ON/OFF	Output of AUX1 0 terminal, ON = 24 Vac Output, OFF = No Output; displays only if AUX1 0 = ERV	
	MECH COOL ON or HEAT STAGES ON	0	0, 1, or 2	Displays number of mechanical cooling stages that are active. Displays the stage of heat pump heating that is active.	
	FAN SPEED	n/a	LOW or HIGH	Displays speed of fan on a 2-speed fan unit	
	W (HEAT IN)	n/a	ON/OFF	Displays status of heat on a 2-speed fan unit.	
SETPOINTS	MAT SET	53°F	38 to 70 °F; increment by 1	The economizer will modulate the OA damper to maintain the mixed air temperature at the setpoint.	
	LOW T LOCK	32°F	-45 to 80 °F; increment by 1	Setpoint determines outdoor temperature when the mechanical cooling cannot be turned on. Commonly referred to as the Compressor lockout. At or below the setpoint the Y1-O and Y2-O will not be energized on the controller.	
	DRYBLB SET	63°F	48 to 80 °F; increment by 1	<i>Dry bulb setpoint will only appear if using dry bulb change over.</i> Setpoint determines where the economizer will assume outdoor air temperature is good for free cooling; e.g.; at 63 °F setpoint unit will economize at 62 °F and below and not economize at 64 °F and above. There is a 2 °F deadband.	
	ENTH CURVE	ES3	ES1, ES2, ES3, ES4, or ES5	<i>ES curve will only appear if using enthalpy changeover.</i> Enthalpy boundary “curves” for economizing using single enthalpy. See page 22 for description of enthalpy curves.	
	DCV SET	1100ppm	500 to 2000 ppm increment by 100	Displays ONLY if a CO2 sensor is connected. Setpoint for Demand Control Ventilation of space. Above the setpoint, the OA dampers will modulate open to bring in additional OA to maintain a space ppm level below the setpoint.	
	MIN POS	2.8 V	2 to 10 Vdc	Displays ONLY if a CO2 sensor is NOT connected. With 2-speed fan units MIN POS L (low speed fan) and MIN POS H (high speed fan) settings are required. Default for MIN POS L is 3.2V and MIN POS H is 2.8V.	
	VENTMAX	2.8 V	2 to 10 Vdc	Displays only if a CO2 sensor is connected. Used for Vbz (ventilation max cfm) setpoint. VENTMAX is the same setting as MIN POS would be if you did not have the CO2 sensor.	
				100 to 9990 cfm increment by 10	If OA, MA RA and CO2 sensors are connected and DCV CAL ENABLE is set to AUTO mode, the OA dampers are controlled by CFM and displays from 100 to 9990 cfm.
				2 to 10 Vdc	With 2-speed fan units VENTMAX L (low speed fan) and VENTMAX H (high speed fan) settings are required. Default for VENTMAX L is 3.2V and VENTMAX H is 2.8V.
	VENTMIN	2.25 V	2 to 10 Vdc	Displays only if CO2 sensor is connected. Used for Va (ventilation min cfm) setpoint. This is the ventilation requirement for less than maximum occupancy of the space.	
				100 to 9990 cfm increment by 10	If OA, MA RA and CO2 sensors are connected and DCV CAL ENABLE is set to AUTO mode, the OA dampers are controlled by CFM and displays from 100 to 9990 cfm.
				2 to 10 Vdc	With 2-speed fan units VENTMIN L (low speed fan) and VENTMIN H (high speed fan) settings are required. Default for VENTMIN L is 2.5V and VENTMIN H is 2.25V.
	ERV OAT SP ^d	32°F	0 to 50 °F; increment by 1	Only when AUX1 0 = ERV	

ECONOMIZER (JADE)

Menu Structure^a. (Continued)

Menu	Parameter	Parameter Default Value	Parameter Range and Increment ^b	Notes
SETPOINTS CONTINUED	EXH1 SET	50%	0 to 100%; increment by 1	Setpoint for OA damper position when exhaust fan 1 is powered by the economizer. With 2-speed fan units Exh1 L (low speed fan) and Exh1 H (high speed fan) settings are required. Default for Exh1 L is 65% and Exh1 H is 50%
	EXH2 SET	75%	0 to 100%; increment by 1	Setpoint for OA damper position when exhaust fan 2 is powered by the economizer. Only used when AUX1 O is set to EHX2. With 2-speed fan units Exh2 L (low speed fan) and Exh2 H (high speed fan) settings are required. Default for Exh2 L is 80% and Exh2 H is 75%
SYSTEM SETUP	INSTALL	01/01/11		Display order = MM/DD/YY Setting order = DD, MM, then YY.
	UNITS DEG	°F	°F or °C	Sets economizer controller in degrees Fahrenheit or Celsius.
	EQUIPMENT	CONV	CONV HP	CONV = conventional. HP O/B = Enables Heat Pump mode. Use AUX2 I for Heat Pump input from thermostat or controller.
	AUX2 IN	n/a	Shutdown (SD) Heat (W1) HP(O) HP(B)	In CONV mode: SD = Enables configuration of shutdown (default); W = Informs controller that system is in heating mode. NOTE: If using 2-speed fan mode, you must program CONV mode for W. Shutdown is not available in the two-speed fan mode. In HP O/B mode: HP(O) = energize heat pump on Cool (default); HP(B) = energize heat pump on Heat.
	FAN SPEED	1 speed	1 speed/ 2 speed	Sets economizer controller for operation of 1 speed or 2 speed supply fan. The controller does not control the fan but positions the OA and RA dampers to the heating or cooling mode. See page 23 for modes and position. NOTE: 2-speed fan option also needs Heat (W1) programmed in AUX 2 In.
	FAN CFM	5000cfm	100 to 50000 cfm; increment by 100	This is the capacity of the RTU. The value is found on the label from the RTU manufacturer. The cfm of the fan is only used with DCV CAL ENABLE AUO
	AUX1 OUT	NONE	NONE ERV EXH2 SYS	<ul style="list-style-type: none"> • NONE = not configured (output is not used) • ERV= Energy Recovery Ventilator^d • EXH2 = second damper position 24 Vac out for second exhaust fan. • SYS = use output as an alarm signal
	OCC	INPUT	INPUT or ALWAYS	When using a setback thermostat with occupancy out (24 Vac), the 24 Vac is input "INPUT" to the OCC terminal. If no occupancy output from the thermostat then change program to "ALWAYS" OR add a jumper from terminal R to OCC terminal.
	FACTORY DEFAULT	NO	NO or YES	Resets all set points to factory defaults when set to YES. LCD will briefly flash YES and change to NO but all parameters will change to factory default values.

ECONOMIZER (JADE)

Menu Structure^a. (Continued)

Menu	Parameter	Parameter Default Value	Parameter Range and Increment ^b	Notes
ADVANCED SETUP	MA LO SET	45 °F	35 to 65 °F; increment by 1°	Temp to activate Freeze Protection (close damper or modulate to MIN POS if temp falls below set value)
	FREEZE POS	CLO	CLO MIN	Damper position when freeze protection is active (closed or MIN POS).
	CO2 ZERO	0ppm	0 to 500 ppm; increment by 10	CO2 ppm level to match CO2 sensor start level.
	CO2 SPAN	2000ppm	1000 to 3000 ppm; increment by 50	CO2 ppm span to match CO2 sensor; e.g.; 500-1500 sensor output would be 500 CO2 zero and 1000 CO2 span. See note on page 6 for C7632 CO2 sensor.
	STG3 DLY	2.0h	0 min, 5 min, 15 min, then 15 min intervals. Up to 4h or OFF	Delay after stage 2 for cool has been active. Turns on 2nd stage of mechanical cooling when economizer is 1st stage call and mechanical cooling is 2nd stage call. Allows three stages of cooling, 1 economizer and 2 mechanical. OFF = no Stage 3 cooling.
	SD DMPR POS	CLO	CLO OPN	Indicates shutdown signal from space thermostat or unitary controller. When controller receives 24 Vac input on the SD terminal in conventional mode, the OA damper will open if programmed for OPN and OA damper will close if programmed for CLO. All other controls, e.g., Y1-O, Y2-O, EXH1, etc. will shut off.
	DA LO ALM	45 °F	NONE 35°F to 65°F in 5°F increments	Used for alarm for when the DA air temperature is too low. Set lower range of alarm, below this temperature the alarm will show on the display.
	DA HI ALM	80 °F	NONE 70 °F to 180 °F in 5° F increments	Used for alarm for when the DA air temperature is too high. Set high range of alarm, above this temperature the alarm will show on the display
	DCVCAL ENA	MAN	MAN (manual) AUTO	Turns on the DCV automatic control of the dampers. Resets ventilation based on the RA, OA and MA sensor conditions. Requires all sensors (RA, OA, MA and CO2). This operation is not operable with a 2-speed fan unit.
	MAT T CAL	0.0 F°	+/-2.5F°	Allows for the operator to adjust for an out of calibration temperature sensor
	OAS T CAL	0.0F°	+/-2.5F°	Allows for the operator to adjust for an out of calibration temperature sensor
	OAS H CAL	0% RH	+/-10% RH	Allows for the operator to adjust for an out of calibration humidity sensor
	RA T CAL	0.0F°	+/-2.5F°	Allows for the operator to adjust for an out of calibration temperature sensor
	RA H CAL	0% RH	+/-10% RH	Allows for the operator to adjust for an out of calibration humidity sensor
	DA T CAL	0.0 F°	+/-2.5F°	Allows for the operator to adjust for an out of calibration temperature sensor
2SP FAN DELAY	5 Minutes	0 to 20 minutes in 1 minute increments.	When in economizing mode this is the delay for the high speed fan to try to satisfy the call for second stage cooling before the first stage mechanical cooling is enabled.	

ECONOMIZER (JADE)

Menu Structure^a. (Continued)

Menu	Parameter	Parameter Default Value	Parameter Range and Increment ^b	Notes
CHECKOUT^f	DAMPER MINIMUM POSITION	n/a	n/a	The checkout for the damper minimum positions is based on the system. See Table 6.
	DAMPER OPEN	n/a	n/a	Positions damper to the full open position. Exhaust fan contacts enable during the DAMPER OPEN test. Make sure you pause in this mode to allow for exhaust contacts to energize due to the delay in the system.
	DAMPER CLOSE	n/a	n/a	Positions damper to the fully closed position.
	CONNECT Y1-O	n/a	n/a	Closes the Y1-O relay (Y1-O). See CAUTION on page 31
	CONNECT Y2-O	n/a	n/a	Closes the Y2-O relay (Y2-O). See CAUTION on page 31
	CONNECT AUX1-O	n/a	n/a	Energizes the AUX1-O output. If AUX1-O setting is: <ul style="list-style-type: none"> • NONE – no action taken • ERV – 24 Vac out. Turns on or signals an ERV that the conditions are not good for economizing but are good for ERV operation.^d • SYS – 24 Vac out. Issues a system alarm.
	CONNECT EXH1	n/a	n/a	Closes the power exhaust fan 1 relay (EXH1)
ALARMS(#)				Alarms display only when they are active. The menu title "ALARMS (#)" includes the number of active alarms in parenthesis (). When using SYLK bus sensors, "SYLK" will appear on the screen, and when using 20k OA temperature sensors, "SENS T" will appear on the screen.
	MA T SENS ERR	n/a	n/a	Mixed air sensor has failed or become disconnected - check wiring then replace sensor if the alarm continues
	CO2 SENS ERR	n/a	n/a	CO2 sensor has failed, gone out of range or become disconnected - check wiring then replace sensor if the alarm continues
	OA SYLK T ERR	n/a	n/a	Outdoor air enthalpy sensor has failed or become disconnected - check wiring then replace sensor if the alarm continues
	OA SYLK H ERR	n/a	n/a	Outdoor air enthalpy sensor has failed or become disconnected - check wiring then replace sensor if the alarm continues
	RA SYLK T ERR	n/a	n/a	Return air enthalpy sensor has failed or become disconnected - check wiring then replace sensor if the alarm continues
	RA SYLK H ERR	n/a	n/a	Return air enthalpy sensor has failed or become disconnected - check wiring then replace sensor if the alarm continues
	DA SYLK T ERR	n/a	n/a	Discharge air sensor has failed or become disconnected - check wiring then replace sensor if the alarm continues
	OA SENS T ERR	n/a	n/a	Outdoor air temperature sensor has failed or become disconnected - check wiring then replace sensor if the alarm continues
	ACT ERROR	n/a	n/a	Actuator has failed or become disconnected - check for stall, over voltage, under voltage and actuator count. Replace actuator if damper is moveable and supply voltage is between 21.6 V and 26.4 V. Check actuator count on STATUS menu.
	FREEZE ALARM	n/a	n/a	Check if outdoor temperature is below the LOW Temp Lockout on setpoint menu. Check if Mixed air temperature on STATUS menu is below the Lo Setpoint on Advanced setup menu. When conditions are back in normal range then the alarm will go away.
	SHUTDOWN ACTIVE	n/a	n/a	AUX2 IN is programmed for SHUTDOWN and 24 V has been applied to AUX 2IN terminal
	DMP CAL RUNNING	n/a	n/a	If DCV Auto enable has been programmed, when the Jade is completing a calibration on the dampers, this alarm will display. Wait until the calibration is completed and the alarm will go away. Must have OA, MA and RA sensors for DCV calibration; set up is in the Advanced setup menu
DA SENS ALM	n/a	n/a	Discharge air temperature is out of the range set in the ADVANCED SETUP Menu. Check the temperature of the discharge air.	

ECONOMIZER (JADE)

Menu Structure^a. (Continued)

Menu	Parameter	Parameter Default Value	Parameter Range and Increment ^b	Notes
ALARMS(#) CONTINUED	SYS ALARM	n/a	n/a	When AUX1-0 is set to SYS and there is any alarm (e.g., failed sensors, etc.), the AUX1-0 terminal has 24 Vac out.
	ACT UNDER V	n/a	n/a	Voltage received by Actuator is above expected range
	ACT OVER V	n/a	n/a	Voltage received by Actuator is below expected range
	ACT STALLED	n/a	n/a	Actuator stopped before achieving commanded position
FEATURES ADJUSTABLE ONLY BY USE OF THE W7220 PC MOD TOOL				
	ACT STALL ALARM SUPPRESSION	Disabled	Enabled or Disabled	If enabled this feature allows the operator to suppress the stall alarm in a specific range of the actuator stroke.
	FACTORY DEFAULTS	n/a	n/a	Allows the operator to hide the factory default menu item using the PC Tool.

^a Table 5 illustrates the complete hierarchy. Your menu parameters may be different depending on your configuration. For example if you do not have a DCV (CO₂) sensor, then none of the DCV parameters appear.

^b When values are displayed, pressing and holding the ▲ or ▼ button causes the display to automatically increment.

^c n/a = not applicable

^d ERV Operation: When in Cooling mode AND the conditions are NOT OK for economizing - the ERV terminal will be energized. In the Heating mode the ERV terminal will be energized when the OA is below the ERV OAT setpoint in the setpoint menu.

^e When used with Honeywell communicating actuator the damper out is reported in XX.X% open versus XX.X Vdc.

^f After 10 minutes without a command or mode change, the controller will change to normal operation.

Table 6. Damper minimum position settings and readings on checkout menu.

Fan Speed	Demand Control Ventilation (CO ₂ Sensor)	Setpoints	Checkout
1	NO	MIN POS	VMAX-HS
1	NO	N/A	N/A
2	NO	MIN POS H	VMAX-HS
2	NO	MIN POS L	VMAX-LS
1	YES	VENT MIN	VMIN-HS
1	YES	VENT MAX	VMAX-HS
2	YES	VENT MIN H	VMIN-HS
2	YES	VENT MAX H	VMAX-LS
2	YES	VENT MINL	N/A
2	YES	VENT MAX L	N/A

ECONOMIZER (JADE)

SEQUENCE OF OPERATION

Dry Bulb Operation No DCV (CO2 sensor) - 1 Speed Fan.

DCV	OA Good to economize?	Y1-I	Y2-I	FAN SPD	Y1-O	Y2-O	Occupied	Unoccupied
None	No	Off	Off	High	0-v/Off	0-v/Off	MIN POS	Closed
		On	Off	High	24-v/On	0-v/Off	MIN POS	Closed
		On	On	High	24-v/On	24-v/On	MIN POS	Closed
None	Yes	Off	Off	High	0-v/Off	0-v/Off	MIN POS	Closed
		On	Off	High	0-v/Off	0-v/Off	MIN POS to Full-Open	Closed to Full-Open
		On	On	High	24-v/On	0-v/Off ^a	MIN POS to Full-Open	Closed to Full-Open

^a With stage 3 delay (STG3 DLY) in Advanced setup menu can turn on 2nd stage of mechanical cooling Y2 –O after the delay if the call for Y1-I and Y2-I have not been satisfied.

Dry Bulb Operation With DCV (CO2 sensor) - 1 Speed Fan.

DCV	OA Good to economize?	Y1-I	Y2-I	FAN SPD	Y1-O	Y2-O	Occupied	Unoccupied
Below CO2 set	No	Off	Off	High	0-v/Off	0-v/Off	VENTMIN	Closed
		On	Off	High	24-v/On	0-v/Off	VENTMIN	Closed
		On	On	High	24-v/On	24-v/On	VENTMIN	Closed
	Yes	Off	Off	High	0-v/Off	0-v/Off	VENTMIN	Closed
		On	Off	High	0-v/Off	0-v/Off	VENTMIN to Full-Open	Closed to Full-Open
		On	On	High	24-v/On	0-v/Off ^a	VENTMIN to Full-Open	Closed to Full-Open
Above CO2 set	No	Off	Off	High	0-v/Off	0-v/Off	VENTMIN to VENTMAX	Closed
		On	Off	High	24-v/On	0-v/Off	VENTMIN to VENTMAX	Closed
		On	On	High	24-v/On	24-v/On	VENTMIN to VENTMAX	Closed
	Yes	Off	Off	High	0-v/Off	0-v/Off	VENTMIN to VENTMAX	Closed
		On	Off	High	0-v/Off	0-v/Off	VENTMIN to Full-Open	Closed to Full-Open
		On	On	High	24-v/On	0-v/Off ^a	VENTMIN to Full-Open	Closed to Full-Open

^a With stage 3 delay (STG3 DLY) in Advanced setup menu can turn on 2nd stage of mechanical cooling Y2 –O after the delay if the call for Y1-I and Y2-I have not been satisfied.

ECONOMIZER (JADE)

Enthalpy Operation No DCV (CO2 sensor) - 1 Speed Fan.

DCV	OA Good to economize?	Y1-I	Y2-I	FAN SPD	Y1-O	Y2-O	Occupied	Unoccupied
None	No	Off	Off	High	0-v/Off	0-v/Off	MIN POS	Closed
		On	Off	High	24-v/On	0-v/Off	MIN POS	Closed
		On	On	High	24-v/On	24-v/On	MIN POS	Closed
None	Yes	Off	Off	High	0-v/Off	0-v/Off	MIN POS	Closed
		On	Off	High	0-v/Off	0-v/Off	MIN POS to Full-Open	Closed to Full-Open
		On	On	High	24-v/On	0-v/Off ^a	MIN POS to Full-Open	Closed to Full-Open

^a With stage 3 delay (STG3 DLY) in Advanced setup menu can turn on 2nd stage of mechanical cooling Y2 –O after the delay if the call for Y1-I and Y2-I have not been satisfied.

Enthalpy Operation With DCV (CO2 sensor) - 1 Speed Fan.

DCV	OA Good to economize?	Y1-I	Y2-I	FAN SPD	Y1-O	Y2-O	Occupied	Unoccupied
Below set	No	Off	Off	High	0-v/Off	0-v/Off	VENTMIN	Closed
		On	Off	High	24-v/On	0-v/Off	VENTMIN	Closed
		On	On	High	24-v/On	24-v/On	VENTMIN	Closed
	Yes	Off	Off	High	0-v/Off	0-v/Off	VENTMIN	Closed
		On	Off	High	0-v/Off	0-v/Off	VENTMIN to Full-Open	Closed to Full-Open
		On	On	High	24-v/On	0-v/Off ^a	VENTMIN to Full-Open	Closed to Full-Open
Above set	No	Off	Off	High	0-v/Off	0-v/Off	VENTMIN to VENTMAX	Closed
		On	Off	High	24-v/On	0-v/Off	VENTMIN L to VENTMAX	Closed
		On	On	High	24-v/On	24-v/On	VENTMIN H to VENTMAX	Closed
	Yes	Off	Off	High	0-v/Off	0-v/Off	VENTMIN L to VENTMAX	Closed
		On	Off	High	0-v/Off	0-v/Off	VENTMIN to Full-Open	Closed to Full-Open
		On	On	High	DELAY ^b 24-v/On	0-v/Off ^a	VENTMIN to Full-Open	Closed to Full-Open

^a With stage 3 delay (STG3 DLY) in Advanced setup menu can turn on 2nd stage of mechanical cooling Y2 –O after the delay if the call for Y1-I and Y2-I have not been satisfied.

^b With 2SP FAN DELAY (Advanced Setup Menu) when in the economizing mode there is a delay for the high speed fan to try to satisfy the call for second stage cooling by turning on the fan to high and opening the OA damper 100% before the first stage mechanical cooling is enabled.

ECONOMIZER (JADE)

Dry Bulb Operation No DCV (CO2 sensor) - 2 Speed Fan.

DCV	OA Good to economize?	Y1-I	Y2-I	FAN SPD	Y1-O	Y2-O	Occupied	Unoccupied
None	No	Off	Off	Low	0-v/Off	0-v/Off	MIN POS L	Closed
		On	Off	Low	24-v/On	0-v/Off	MIN POS L	Closed
		On	On	High	24-v/On	24-v/On	MIN POS H	Closed
None	Yes	Off	Off	Low	0-v/Off	0-v/Off	MIN POS L	Closed
		On	Off	Low	0-v/Off	0-v/Off	MIN POS L to Full-Open	Closed to Full-Open
		On	On	High	DELAY ^b 24-v/On	0-v/Off ^a	MIN POS H to Full-Open	Closed to Full-Open

^aWith stage 3 delay (STG3 DLY) in Advanced setup menu can turn on 2nd stage of mechanical cooling Y2 –O after the delay if the call for Y1-I and Y2-I have not been satisfied.

^bWith 2SP FAN DELAY (Advanced Setup Menu) when in the economizing mode there is a delay for the high speed fan to try to satisfy the call for second stage cooling by turning on the fan to high and opening the OA damper 100% before the first stage mechanical cooling is enabled.

Dry Bulb Operation With DCV (CO2 sensor) - 2 Speed Fan.

DCV	OA Good to economize?	Y1-I	Y2-I	FAN SPD	Y1-O	Y2-O	Occupied	Unoccupied
Below set	No	Off	Off	Low	0-v/Off	0-v/Off	VENTMIN L	Closed
		On	Off	Low	24-v/On	0-v/Off	VENTMIN L	Closed
		On	On	High	24-v/On	24-v/On	VENTMIN H	Closed
	Yes	Off	Off	Low	0-v/Off	0-v/Off	VENTMIN L	Closed
		On	Off	Low	0-v/Off	0-v/Off	VENTMIN L to Full-Open	Closed to Full-Open
		On	On	High	24-v/On	0-v/Off ^a	VENTMIN H to Full-Open	Closed to Full-Open
Above set	No	Off	Off	Low	0-v/Off	0-v/Off	VENTMIN L to VENTMAX	Closed
		On	Off	Low	24-v/On	0-v/Off	VENTMIN L to VENTMAX	Closed
		On	On	High	24-v/On	24-v/On	VENTMIN H to VENTMAX	Closed
	Yes	Off	Off	Low	0-v/Off	0-v/Off	VENTMIN L to VENTMAX	Closed
		On	Off	Low	0-v/Off	0-v/Off	VENTMIN L to Full-Open	Closed to Full-Open
		On	On	High	DELAY ^b 24-v/On	0-v/Off ^a	VENTMIN H to Full-Open	Closed to Full-Open

^aWith stage 3 delay (STG3 DLY) in Advanced setup menu can turn on 2nd stage of mechanical cooling Y2 –O after the delay if the call for Y1-I and Y2-I have not been satisfied.

^bWith 2SP FAN DELAY (Advanced Setup Menu) when in the economizing mode there is a delay for the high speed fan to try to satisfy the call for second stage cooling by turning on the fan to high and opening the OA damper 100% before the first stage mechanical cooling is enabled.

Enthalpy Operation No DCV (CO2 sensor) - 2 Speed Fan.

DCV	OA Good to economize?	Y1-I	Y2-I	FAN SPD	Y1-O	Y2-O	Occupied	Unoccupied
NO CO2 SENSOR	No	Off	Off	Low	0-v/Off	0-v/Off	MIN POS L	Closed
		On	Off	Low	24-v/On	0-v/Off	MIN POS L	Closed

ECONOMIZER (JADE)

DCV	OA Good to economize?	Y1-I	Y2-I	FAN SPD	Y1-O	Y2-O	Occupied	Unoccupied
		On	On	High	24-v/On	24-v/On	MIN POS H	Closed
	Yes	Off	Off	Low	0-v/Off	0-v/Off	MIN POS L	Closed
		On	Off	Low	0-v/Off	0-v/Off	MIN POS L to Full-Open	Closed to Full-Open
		On	On	High	DELAY ^b 24-v/On	0-v/Off ^a	MIN POS H to Full-Open	Closed to Full-Open

^aWith stage 3 delay (STG3 DLY) in Advanced setup menu can turn on 2nd stage of mechanical cooling Y2 –O after the delay if the call for Y1-I and Y2-I have not been satisfied.

^bWith 2SP FAN DELAY (Advanced Setup Menu) when in the economizing mode there is a delay for the high speed fan to try to satisfy the call for second stage cooling by turning on the fan to high and opening the OA damper 100% before the first stage mechanical cooling is enabled.



ECONOMIZER (JADE)

Enthalpy Operation With DCV (CO2 sensor) - 2 Speed Fan.

DCV	OA Good to economize?	Y1-I	Y2-I	FAN SPD	Y1-O	Y2-O	Occupied	Unoccupied
Below set	No	Off	Off	Low	0-v/Off	0-v/Off	VENTMIN L	Closed
		On	Off	Low	24-v/On	0-v/Off	VENTMIN L	Closed
		On	On	High	24-v/On	24-v/On	VENTMIN H	Closed
	Yes	Off	Off	Low	0-v/Off	0-v/Off	VENTMIN L	Closed
		On	Off	Low	0-v/Off	0-v/Off	VENTMIN L to Full-Open	Closed to Full-Open
		On	On	High	24-v/On	0-v/Off ^a	VENTMIN H to Full-Open	Closed to Full-Open
Above set	No	Off	Off	Low	0-v/Off	0-v/Off	VENTMIN L to VENTMAX	Closed
		On	Off	Low	24-v/On	0-v/Off	VENTMIN L to VENTMAX	Closed
		On	On	High	24-v/On	24-v/On	VENTMIN H to VENTMAX	Closed
	Yes	Off	Off	Low	0-v/Off	0-v/Off	VENTMIN L to VENTMAX	Closed
		On	Off	Low	0-v/Off	0-v/Off	VENTMIN L to Full-Open	Closed to Full-Open
		On	On	High	DELAY ^b 24-v/On	0-v/Off ^a	VENTMIN H to Full-Open	Closed to Full-Open

^aWith stage 3 delay (STG3 DLY) in Advanced setup menu can turn on 2nd stage of mechanical cooling Y2 –O after the delay if the call for Y1-I and Y2-I have not been satisfied.

^bWith 2SP FAN DELAY (Advanced Setup Menu) when in the economizing mode there is a delay for the high speed fan to try to satisfy the call for second stage cooling by turning on the fan to high and opening the OA damper 100% before the first stage mechanical cooling is enabled.



Single Enthalpy curve and boundaries.

Single Enthalpy and Dual Enthalpy High Limit Curves.

Enthalpy Curve	Temp. Dry-Bulb (°F)	Temp. Dewpoint (°F)	Enthalpy (btu/lb/da)	Point P1		Point P2	
				Temp. °F	Humidity %RH	Temp. °F	Humidity %RH
ES1	80.0	60.0	28.0	80.0	36.8	66.3	80.1
ES2	75.0	57.0	26.0	75.0	39.6	63.3	80.0
ES3	70.0	54.0	24.0	70.0	42.3	59.7	81.4
ES4	65.0	51.0	22.0	65.0	44.8	55.7	84.2
ES5	60.0	48.0	20.0	60.0	46.9	51.3	88.5
HL	86.0	66.0	32.4	86.0	38.9	72.4	80.3

ECONOMIZER (JADE)

ENTHALPY SETTINGS

When the OA temperature, enthalpy and dew point are below the respective setpoints, the Outdoor Air can be used for economizing. Fig. 22 shows the new single enthalpy boundaries in the W7220. There are 5 boundaries (setpoints ES1 through ES5), which are defined by dry bulb temperature, enthalpy and dew point.

Refer to Table 15 for the ENTH CURVE setpoint values.

To use enthalpy the W7220 must have a C7400S Sylkbus sensor for OA. The W7220 calculates the enthalpy and dew point using the OA temperature and humidity input from the OA sensor. When the OA temperature, OA humidity and OA dew point are all below the selected boundary, the economizer sets the economizing mode to YES, economizing is available.

When conditions are above the selected boundary, the conditions are not good to economize and the mode is set to NO.

Fig. 22 shows the 5 current boundaries. There is also a high limit boundary for differential enthalpy. The high limit boundary is ES1 when there are no stages of mechanical cooling energized and HL when a compressor stage is energized.

Table 15 provides the values for each boundary limit.

TWO-SPEED FAN OPERATION

The later versions of the W7220 Jade controller have the capability to work with a system using a 2-speed supply fan. The W7220 does not control the supply directly but uses the following input status to determine the speed of the supply fan and controls the OA damper to the required position.

State	Fan Speed
OCC	Low
Y1	Low
Y2	High
W	High

The W (heating mode) is not controlled by the W7220 but it requires the status to know where to position the OA damper for minimum position for the fan speed.

The 2 speed fan delay is available when the system is programmed for 2 speed fan (in the System Setup menu item). The 2 speed fan delay is defaulted to 5 minutes and can be changed in the Advanced Setup menu item. When the unit has a call for Y1 In and in the free cooling mode and there is a call for Y2 In, the 2-speed fan delay starts and the OA damper will modulate 100% open, the supply fan should be set to high speed by the unit controller. After the delay one of two actions will happen:

- The Y2 In call will be satisfied with the damper 100% open and fan on high speed and the call will turn off
- OR
- If the call for additional cooling in the space has not been satisfied then the first stage of mechanical cooling will be enabled through Y1 Out or Y2 Out.

ECONOMIZER (JADE)

CHECKOUT

Inspect all wiring connections at the Economizer module's terminals, and verify compliance with the installation wiring diagrams.

For checkout, review the Status of each configured parameter and perform the Checkout tests.

NOTE: See "Interface Overview" on page 18. for information about menu navigation and use of the keypad.

 **WARNING**

**ELECTRICAL SHOCK HAZARD!
CAN CAUSE SEVERE INJURY, DEATH OR
PROPERTY DAMAGE.
DISCONNECT POWER SUPPLY BEFORE
BEGINNING WIRING OR MAKING WIRING
CONNECTIONS, TO PREVENT ELECTRICAL SHOCK
OR EQUIPMENT DAMAGE.
IF ANY WIRING CHANGES ARE REQUIRED,
FIRST BE SURE TO REMOVE POWER FROM THE
ECONOMIZER MODULE BEFORE STARTING
WORK. PAY PARTICULAR ATTENTION TO
VERIFYING THE POWER CONNECTION (24 VAC).**



POWER UP

After the module is mounted and wired, apply power.

INITIAL MENU DISPLAY

On initial start up, Honeywell displays on the first line and Economizer W7220 on the second line. After a brief pause, the revision of the software appears on the first line and the second line will be blank.

POWER LOSS (OUTAGE OR BROWNOUT)

All setpoints and advanced settings are restored after any power loss or interruption.

a All settings are stored in non-volatile flash memory.

STATUS

Use the Status menu (see Table 5) to check the parameter values for the various devices and sensors configured.

NOTE: See "Interface Overview" on page 18. for information about menu navigation and use of the keypad.

CHECKOUT TESTS

Use the Checkout menu (Table 5) to test the damper operation and any configured outputs. Only items that are configured are shown in the Checkout menu.

NOTE: See "Interface Overview" on page 18. for information about menu navigation and use of the keypad.

To perform a Checkout Test:

1. Scroll to the desired test in the Checkout menu using the ▲ and ▼ buttons.
2. Press the ← button to select the item.
3. RUN? appears on the display.
4. Press the ← button to start the test.
5. The unit pauses and then displays IN PROGRESS
6. When all parameters have been tested, press the ⏪ button (Menu up) to end the test (e.g. turn off the relay).

The checkout tests can all be performed at the time of installation or any time during the operation of the system as a test that the system is operable.

 **CAUTION**

**EQUIPMENT DAMAGE MAY RESULT!
BE SURE TO ALLOW ENOUGH TIME FOR COMPRESSOR
STARTUP AND SHUTDOWN BETWEEN CHECKOUT TESTS
SO THAT YOU DO NOT SHORT-CYCLE THE COMPRESSORS.**

TROUBLESHOOTING

ALARMS

The Economizer module provides alarm messages that display on the 2-line LCD.

NOTE: Upon power up, the module waits 60 minutes before checking for alarms. This allows time for all the configured devices (e.g. sensors, actuator) to become operational. The exception is the MA sensor which will alarm immediately.

If one or more alarms are present and there has been no keypad activity for at least 5 minutes, the Alarms menu displays and cycles through the active alarms.



You can also navigate to the Alarms menu at any time.

ECONOMIZER (JADE)

CLEARING ALARMS

Once the alarm has been identified and the cause has been removed (e.g. replaced faulty sensor), the alarm can be cleared from the display.

To clear an alarm, perform the following:

1. Navigate to the desired alarm.
2. Press the  button.
3. ERASE? displays.
4. Press the  button.
5. ALARM ERASED displays.
6. Press the  button (MenuUp/Exit) to complete the action and return to the previous menu.

NOTE: If the alarm still exists after you clear it, it re-displays within 5 seconds.



SMOKE DETECTOR

DIP SWITCH SETTINGS:

Designation	Default	Selection	Features
TRBL SHUTDN	OFF	OFF	Aux relay does not switch states with a Trouble condition
		ON	Aux relay switches states with a Trouble condition
SENSORS	1	1	Only one sensor is connected the Power Board
		2	Two sensors are connected to the Power Board
MIN TMPR DELAY	7	7	Provides a Trouble condition (terminals 3 and 14 open) when Sensor Housing cover has been removed or has been secured improperly for more than 7 minutes
		0	Provides an instantaneous Trouble condition(terminals 3 and 14 open) upon cover removal

DETECTOR STATUS INDICATION

NOTE: There are two LED's on the Power board D4P120, each indicating the Status of the two sensors connected. When there is only one sensor connected, LED2 will remain off.

Status	Description	LED Status		Status of Relays
		Sensor D4S	Power Board D4P120	
Sensor Initialization	At power-up or reset at the panel, the sensor will take approx 35 seconds to initialize. Also occurs if the sensor has been removed and restored in the base in the sensor housing.	RED Blink every 5 seconds	Alternating Green/amber every 1 second	Supervisory relay: Terminals 3 and 14 are closed. Alarm Relay: Terminals 4 and 5 are open. Aux Relay does not switch states:Terminals 6 and 16 are closed,Terminals 8 and 18 are closed
	Sensor is missing during the seven minute tamper Delay, if selected.	Off	Alternating Green/amber every 1 second	Supervisory relay: Terminals 3 and 14 are closed Alarm Relay: Terminals 4 and 5 are open. Aux Relay does not switch states:Terminals 6 and 16 are closed,Terminals 8 and 18 are closed
Maintenance	Sensor D4S is outside it's UL approved sensitivity limits and needs to be cleaned or replaced.	RED Blink every 5 seconds	Amber Blink every 5 seconds	Supervisory relay: Terminals 3 and 14 are closed. Alarm Relay: Terminals 4 and 5 are open. Aux Relay does not switch states:Terminals 6 and 16 are closed,Terminals 8 and 18 are closed
Trouble	.Unit loses Power	Off	Off	Supervisory relay: Terminals 3 and 14 are open. Alarm Relay: Terminals 4 and 5 are open. Aux Relay does not switch states with no shutdown on Trouble selected: Terminals 6 and 16 are closed. Terminals 8 and 18 are closed. Aux Relay Switches states with shutdown on Trouble selected: Terminals 6 and 16 are open, Terminals 8 and 18 are open
	.Cover Tamper Delay times out	Green Blink every 5 seconds	Amber solid	
	.Wiring Problems between the Sensor and the Power Board	Off	Amber solid	
	.Mismatch between the number of sensors connected and the Dip Switch setting			
	1 sensor connected,2 selected	Green blink every 5 seconds on first sensor. No second sensor.	LED1 Green blink every 5 seconds LED2 Amber solid	
2 sensors connected,1 selected	Green blink every 5 seconds on first sensor. LED's off on second sensor	LED1 Green blink every 5 seconds LED2 Amber solid		
Alarm	Unit detects smoke	Solid Red	Solid Red	Supervisory relay: Terminals 3 and 14 are closed Alarm Relay: Terminals 4 and 5 are closed. Aux Relay switches states: Terminals 6 and 16 are open, Terminals 8 and 18 are open
Standby	Unit has Power and it is not in initialization, Trouble, Maintenance or Alarm.	Green Blink every 5 seconds	Green Blink every 5 seconds	Supervisory relay: Terminals 3 and 14 are closed Alarm Relay: Terminals 4 and 5 are open. Aux Relay does not switch states: Terminals 6 and 16 are closed, Terminals 8 and 18 are closed

NOTE: If any other visual indication is noted contact System Sensor technical support at 1-800-SENSOR2.

DBC WIRING DIAGRAMS



SMALL CHASSIS BELC

WARNING

HIGH VOLTAGE!

DISCONNECT ALL POWER BEFORE SERVICING OR INSTALLING THIS UNIT.
MULTIPLE POWER SOURCES MAY BE PRESENT. FAILURE TO DO SO MAY
CAUSE PROPERTY DAMAGE, PERSONAL INJURY OR DEATH.

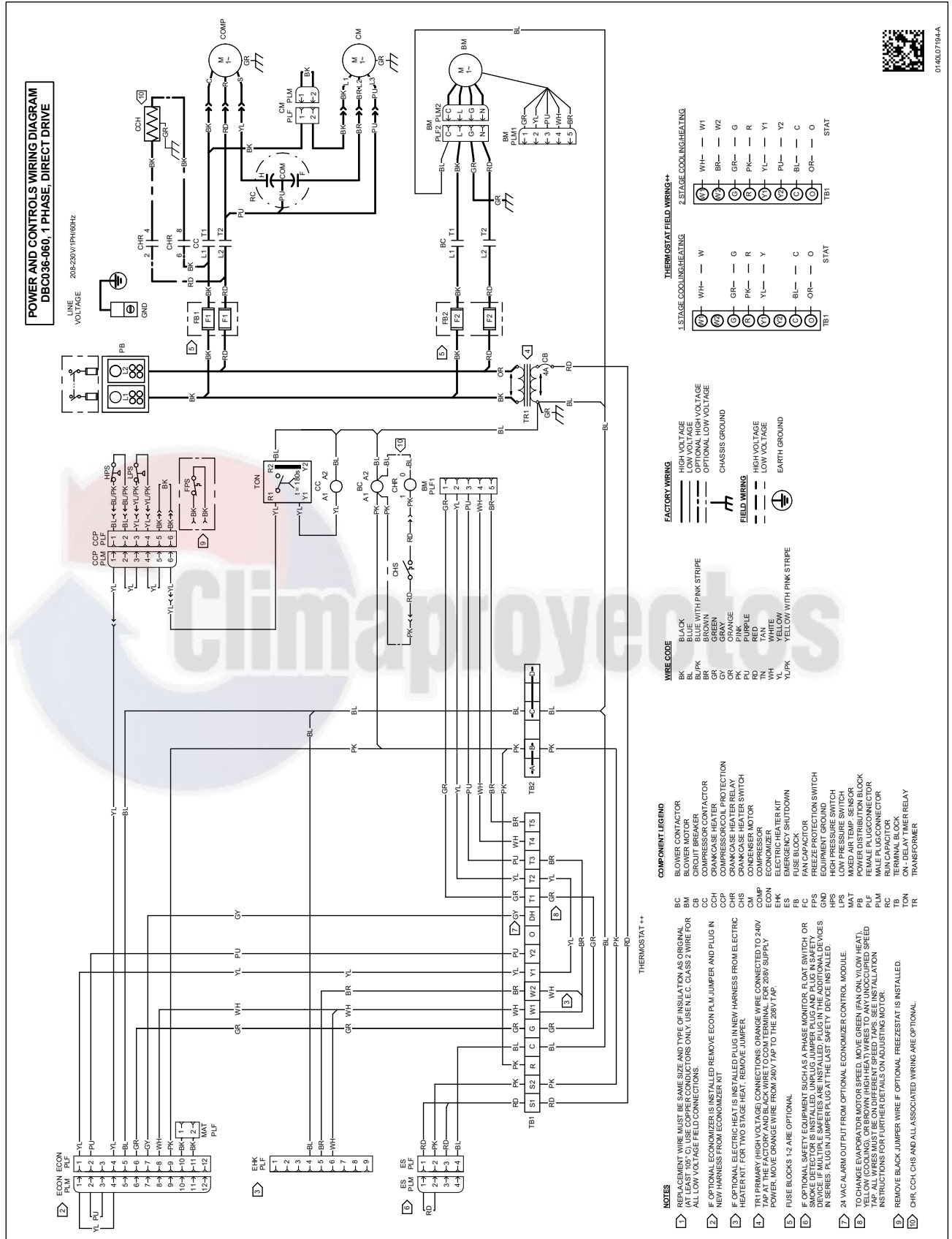

0148.0719A4

Wiring is subject to change. Always refer to the wiring diagram on the unit for the most up-to-date wiring.

UNIT WIRING DIAGRAMS

DBC036-060 3PH , DIRECT

WARNING

HIGH VOLTAGE!
 DISCONNECT ALL POWER BEFORE SERVICING OR INSTALLING THIS UNIT.
 MULTIPLE POWER SOURCES MAY BE PRESENT. FAILURE TO DO SO MAY
 CAUSE PROPERTY DAMAGE, PERSONAL INJURY OR DEATH.

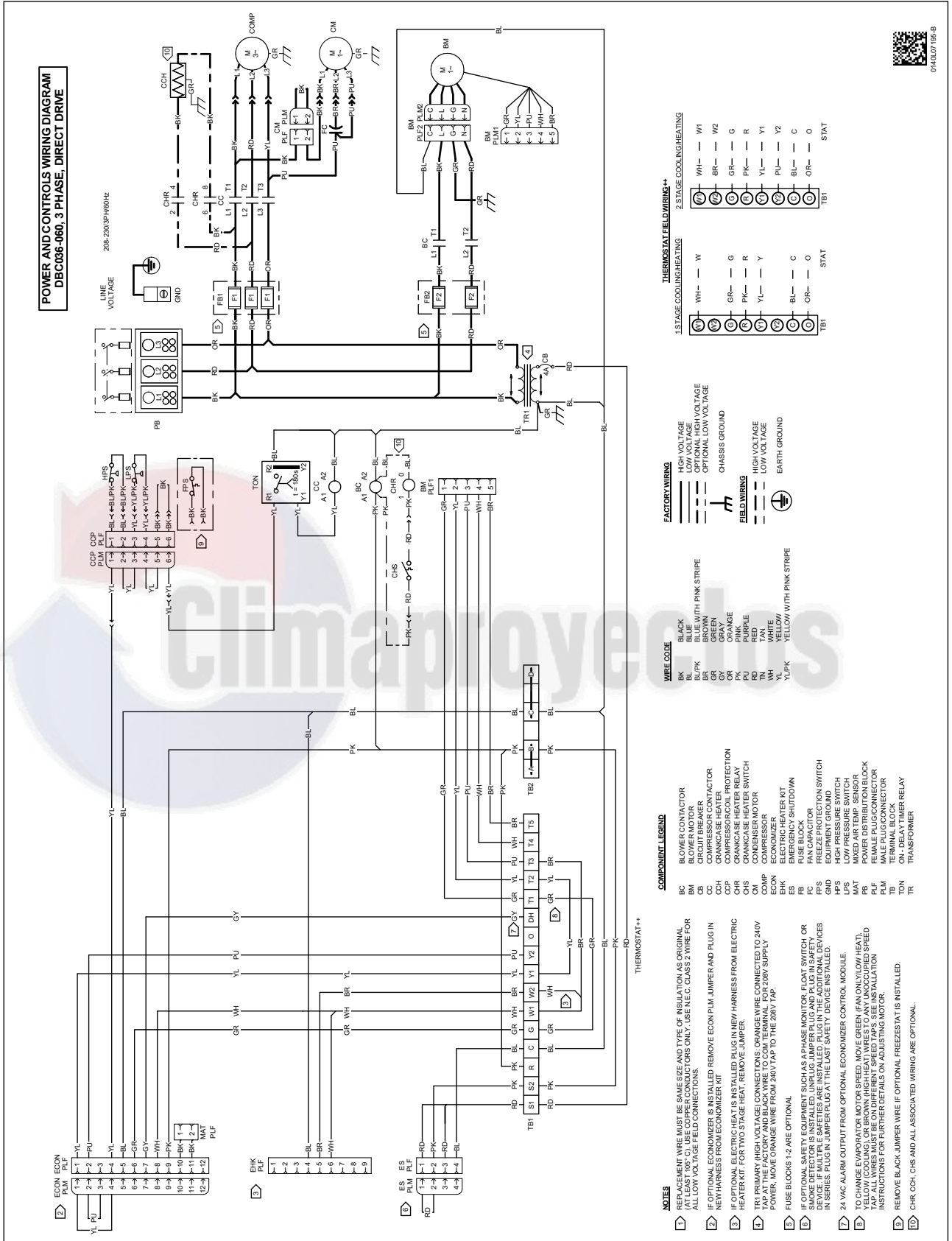

Wiring is subject to change. Always refer to the wiring diagram on the unit for the most up-to-date wiring.



WARNING

HIGH VOLTAGE!
 DISCONNECT ALL POWER BEFORE SERVICING OR INSTALLING THIS UNIT.
 MULTIPLE POWER SOURCES MAY BE PRESENT. FAILURE TO DO SO MAY
 CAUSE PROPERTY DAMAGE, PERSONAL INJURY OR DEATH.

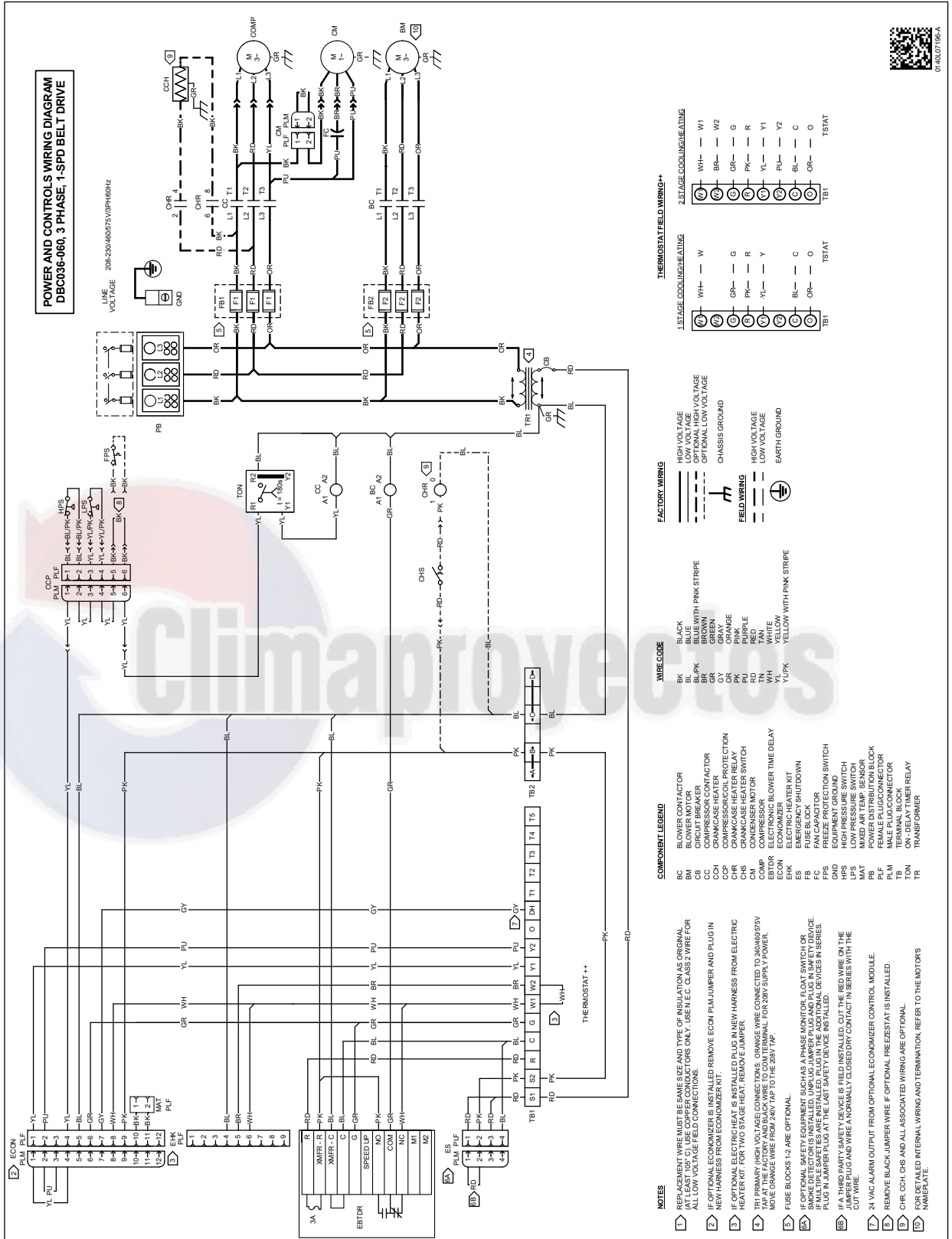

POWER AND CONTROLS WIRING DIAGRAM
 DBC036-060, 3 PHASE, 1-SPD BELT DRIVE

LINE VOLTAGE 208-230V/460/575V/3PH/60HZ

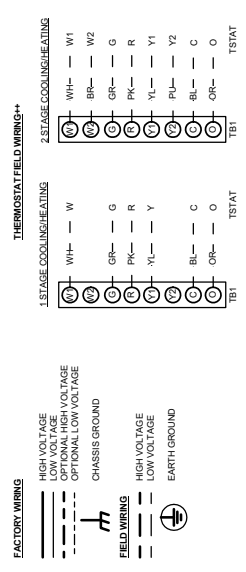

COMPONENT	LEGEND	WIRE CODE
BC	BLOWER CONTACTOR	BK
BM	BLOWER MOTOR	BL
CB	CIRCUIT BREAKER	BLPK
CC	COMMON STOP CONTACTOR	GR
CCCH	COMPRESSOR CONTACTOR	GRN
CCP	COMPRESSOR COIL PROTECTION	GY
CHR	CRANKCASE HEATER SWITCH	PK
CHS	CRANKCASE HEATER SWITCH	PK
CH	CRANKCASE HEATER MOTOR	PK
COMP	COMPRESSOR	PU
CON	CONDENSER FAN MOTOR	PU
EBTOR	ELECTRONIC BLOWER TIME DELAY	TN
EMK	EMERGENCY SHUTDOWN	WH
ES	ELECTRIC HEATER KIT	WH
FB	FUSE BLOCK	YLPK
FBS	FUSE BLOCK	YLPK
FR	FREEZE PROTECTION SWITCH	YLPK
GND	EQUIPMENT GROUND	CHASSIS GROUND
MA	MAXED AIR TEMP SENSOR	CHASSIS GROUND
MS	MAXED AIR TEMP SENSOR	CHASSIS GROUND
PB	POWER DISTRIBUTION BLOCK	CHASSIS GROUND
PLF	FEMALE PLUG/CONNECTOR	CHASSIS GROUND
PM	MALE PLUG/CONNECTOR	CHASSIS GROUND
TB	TERMINAL BLOCK	CHASSIS GROUND
TON	ON-DELAY/TIMER RELAY	CHASSIS GROUND
TR	TRANSFORMER	CHASSIS GROUND

- NOTES**
- REPLACE WIRE MUST BE SAME SIZE AND TYPE OF INSULATION AS ORIGINAL (AT LEAST 10% O). USE COPPER CONDUCTORS ONLY. USE N.E.C. CLASS 2 WIRE FOR ALL LOW VOLTAGE FIELD CONNECTIONS.
 - IF OPTIONAL ECONOMIZER IS INSTALLED REMOVE ECON PLUG/JUMPER AND PLUG IN NEW HARNESS FROM ECONOMIZER KIT.
 - IF OPTIONAL ELECTRIC HEAT IS INSTALLED PLUG IN NEW HARNESS FROM ELECTRIC HEATER KIT. FOR TWO STAGE HEAT, REMOVE E JUMPER.
 - IF PRIMARY HIGH VOLTAGE CONNECTIONS, CHANGE WIRE CONNECTED TO 208/460/575V MOVE ORANGE WIRE FROM Z8V TAP TO THE 208V TAP.
 - FUSE BLOCKS 1,2 ARE OPTIONAL.
 - IF OPTIONAL SAFETY EQUIPMENT SUCH AS A PHASE MONITOR, FLOAT SWITCH OR SMOKE DETECTOR IS INSTALLED, UNPLUG JUMPER PLUG AND PLUG IN SAFETY DEVICE. IF MULTIPLE SAFETIES ARE INSTALLED, UNPLUG JUMPER PLUG AND PLUG IN SAFETY DEVICE.
 - IF A PLUG IN SAFETY DEVICE IS USED, THE SAFETY DEVICE AND SAFETY WIRE ON THE JUMPER PLUG AND WIRE NORMALLY CLOSED/DT CONTACT IN SERIES WITH THE CUT WIRE.
 - 24 VAC ALARM OUTPUT FROM OPTIONAL ECONOMIZER CONTROL MODULE.
 - REMOVE BLACK JUMPER WIRE IF OPTIONAL FREEZE/STAT IS INSTALLED.
 - CHR, CCH, CHS AND ALL ASSOCIATED WIRING ARE OPTIONAL.
 - FOR DETAILED INTERNAL WIRING AND TERMINATION, REFER TO THE MOTORS NAMEPLATE.



09/06/2019

WARNING

HIGH VOLTAGE!

DISCONNECT ALL POWER BEFORE SERVICING OR INSTALLING THIS UNIT.
MULTIPLE POWER SOURCES MAY BE PRESENT. FAILURE TO DO SO MAY
CAUSE PROPERTY DAMAGE, PERSONAL INJURY OR DEATH.

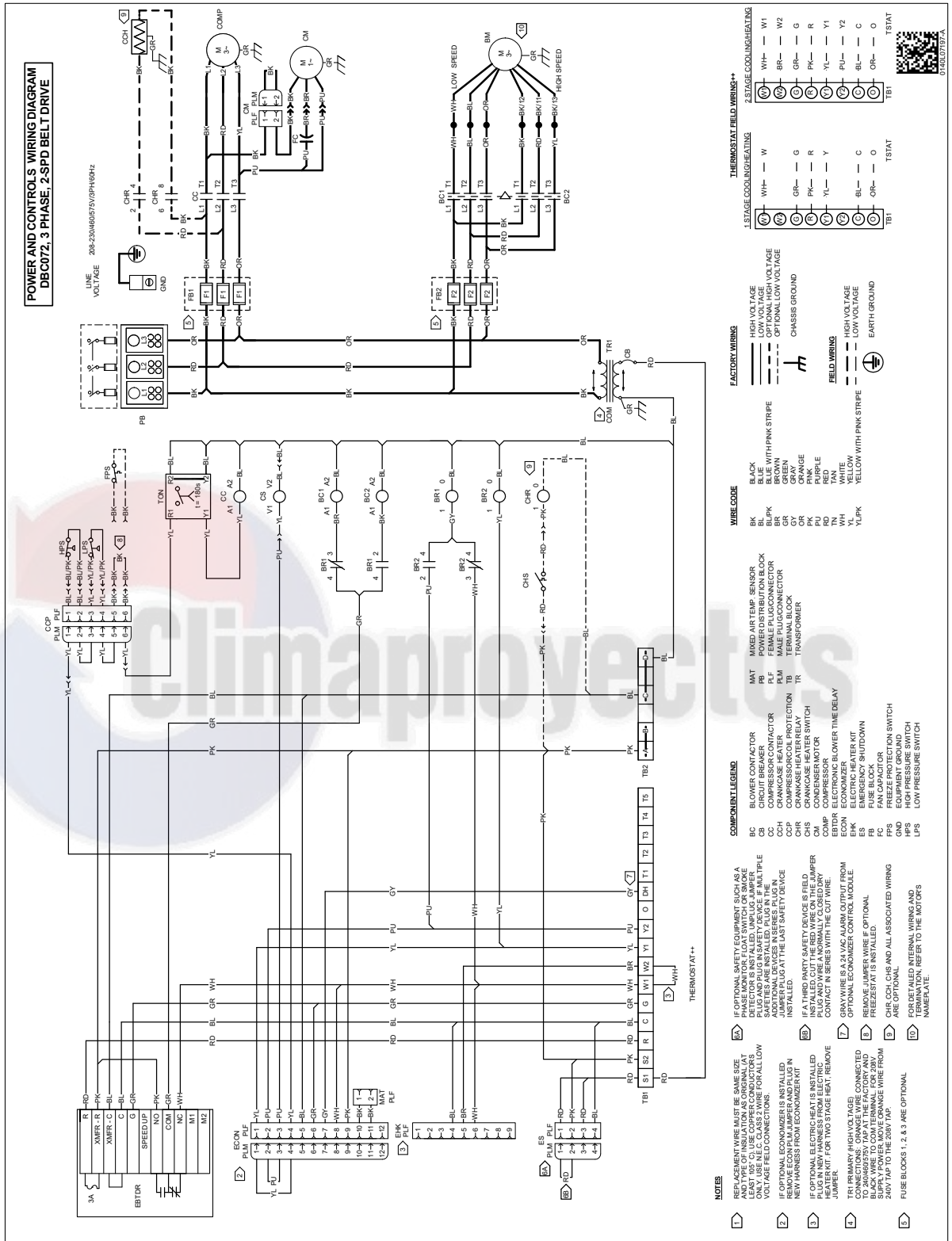

Wiring is subject to change. Always refer to the wiring diagram on the unit for the most up-to-date wiring.

MEDIUM CHASSIS BELC



WARNING

HIGH VOLTAGE!
 DISCONNECT ALL POWER BEFORE SERVICING OR INSTALLING THIS UNIT.
 MULTIPLE POWER SOURCES MAY BE PRESENT. FAILURE TO DO SO MAY
 CAUSE PROPERTY DAMAGE, PERSONAL INJURY OR DEATH.

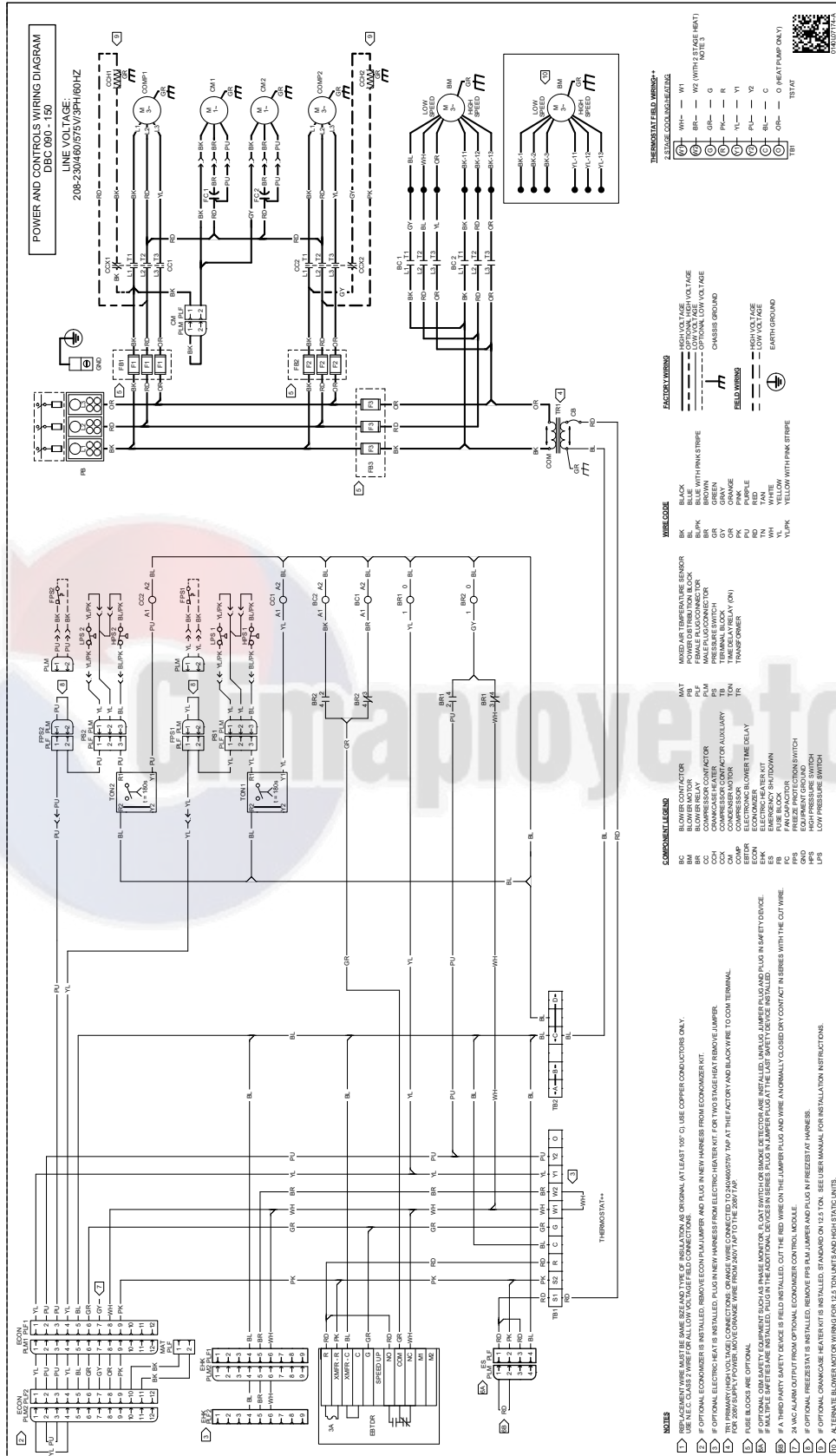

Wiring is subject to change. Always refer to the wiring diagram on the unit for the most up-to-date wiring.

LARGE CHASSIS BELC

WARNING

HIGH VOLTAGE!
DISCONNECT ALL POWER BEFORE SERVICING OR INSTALLING THIS UNIT.
MULTIPLE POWER SOURCES MAY BE PRESENT. FAILURE TO DO SO MAY
CAUSE PROPERTY DAMAGE, PERSONAL INJURY OR DEATH.

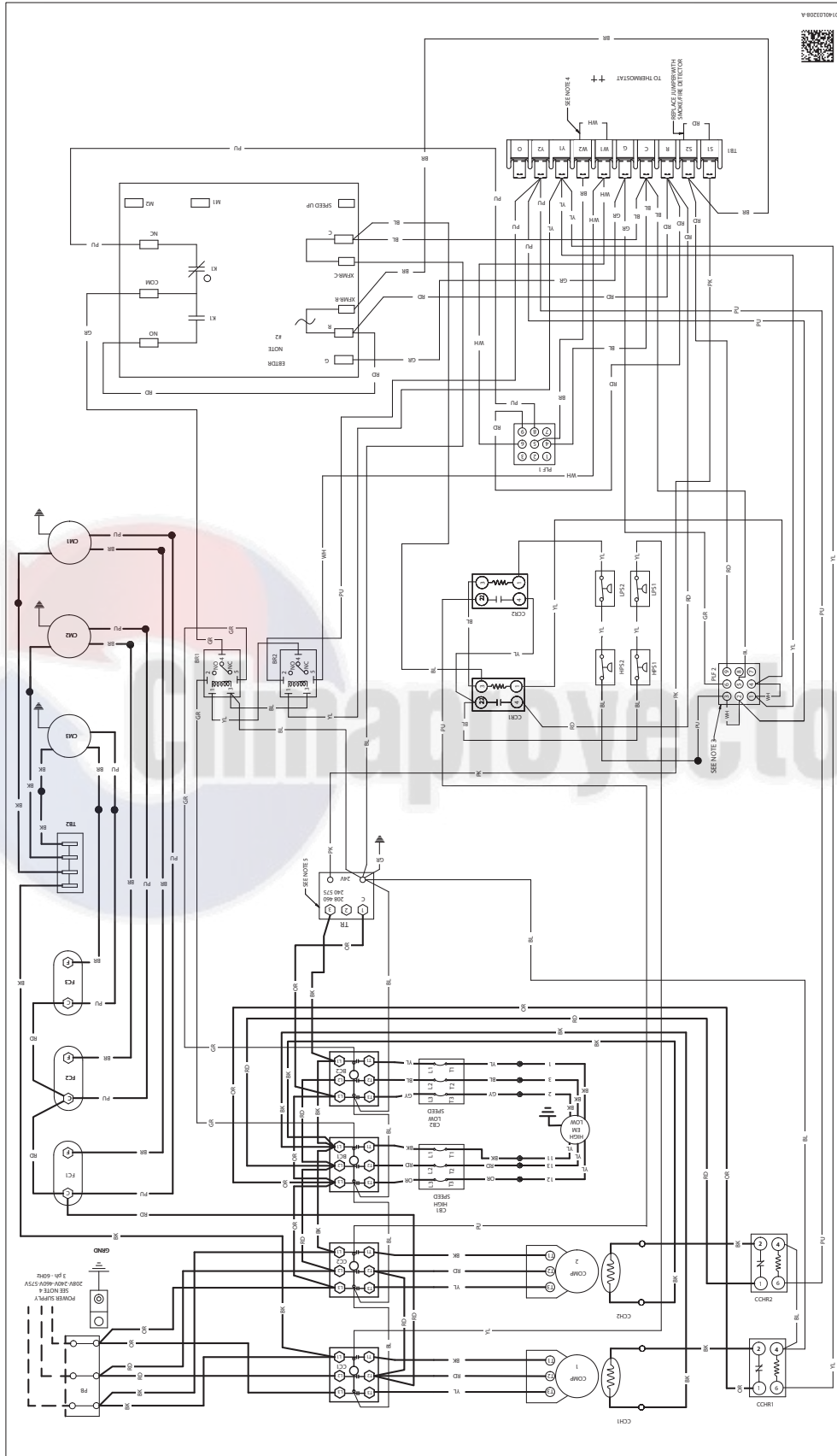

Wiring is subject to change. Always refer to the wiring diagram on the unit for the most up-to-date wiring.

HIGH VOLTAGE!
DISCONNECT ALL POWER BEFORE SERVICING OR INSTALLING THIS UNIT.
MULTIPLE POWER SOURCES MAY BE PRESENT. FAILURE TO DO SO MAY CAUSE PROPERTY DAMAGE, PERSONAL INJURY OR DEATH.

WARNING

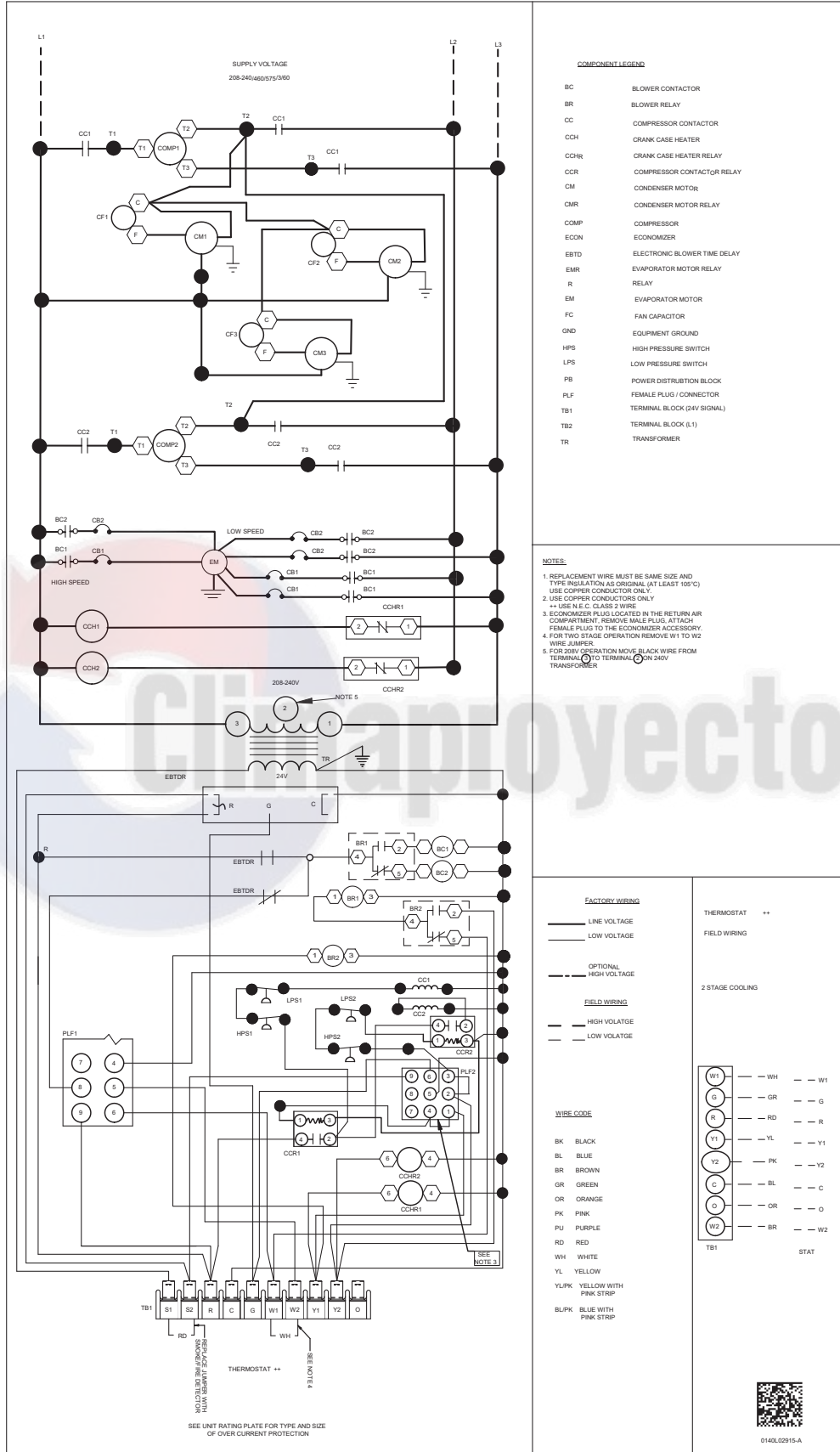

COMPONENT LEGEND

- BC BLOWER CONTACTOR
- BR BLOWER RELAY
- CC COMPRESSOR CONTACTOR
- CCH CRANK CASE HEATER
- CCHR CRANK CASE HEATER RELAY
- CCR COMPRESSOR CONTACTOR RELAY
- CM CONDENSER MOTOR
- CMR CONDENSER MOTOR RELAY
- COMP COMPRESSOR
- ECON ECONOMIZER
- EBTD ELECTRONIC BLOWER TIME DELAY
- EMR EVAPORATOR MOTOR RELAY
- R RELAY
- EM EVAPORATOR MOTOR
- FC FAN CAPACITOR
- GND EQUIPMENT GROUND
- HPS HIGH PRESSURE SWITCH
- LPS LOW PRESSURE SWITCH
- PB POWER DISTRIBUTION BLOCK
- PLF FEMALE PLUG / CONNECTOR
- TB1 TERMINAL BLOCK (24V SIGNAL)
- TB2 TERMINAL BLOCK (L1)
- TR TRANSFORMER

NOTES:

1. REPLACEMENT WIRE MUST BE SAME SIZE AND TYPE INSULATION AS ORIGINAL (AT LEAST 105°C) USE COPPER CONDUCTOR ONLY.
2. USE COPPER CONDUCTORS ONLY
3. ECONOMIZER PLUG LOCATED IN THE RETURN AIR COMPARTMENT. REMOVE MALE PLUG, ATTACH FEMALE PLUG TO THE ECONOMIZER ACCESSORY.
4. FOR TWO STAGE OPERATION REMOVE W1 TO W2 WIRE JUMPER
5. FOR 20V OPERATION MOVE BLACK WIRE FROM TERMINAL (1) TO TERMINAL (2) ON 240V TRANSFORMER

FACTORY WIRING

- LINE VOLTAGE
- LOW VOLTAGE
- OPTIONAL HIGH VOLTAGE
- FIELD WIRING
- HIGH VOLTAGE
- LOW VOLTAGE

WIRE CODE

- BK BLACK
- BL BLUE
- BR BROWN
- GR GREEN
- OR ORANGE
- PK PINK
- PU PURPLE
- RD RED
- WH WHITE
- YL YELLOW
- YL/PK YELLOW WITH PINK STRIP
- BL/PK BLUE WITH PINK STRIP

THERMOSTAT ++

FIELD WIRING

2 STAGE COOLING

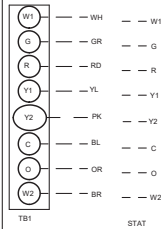

0140L02915-A

Wiring is subject to change. Always refer to the wiring diagram on the unit for the most up-to-date wiring.



WARNING

HIGH VOLTAGE!

DISCONNECT ALL POWER BEFORE SERVICING OR INSTALLING THIS UNIT.
MULTIPLE POWER SOURCES MAY BE PRESENT. FAILURE TO DO SO MAY
CAUSE PROPERTY DAMAGE, PERSONAL INJURY OR DEATH.



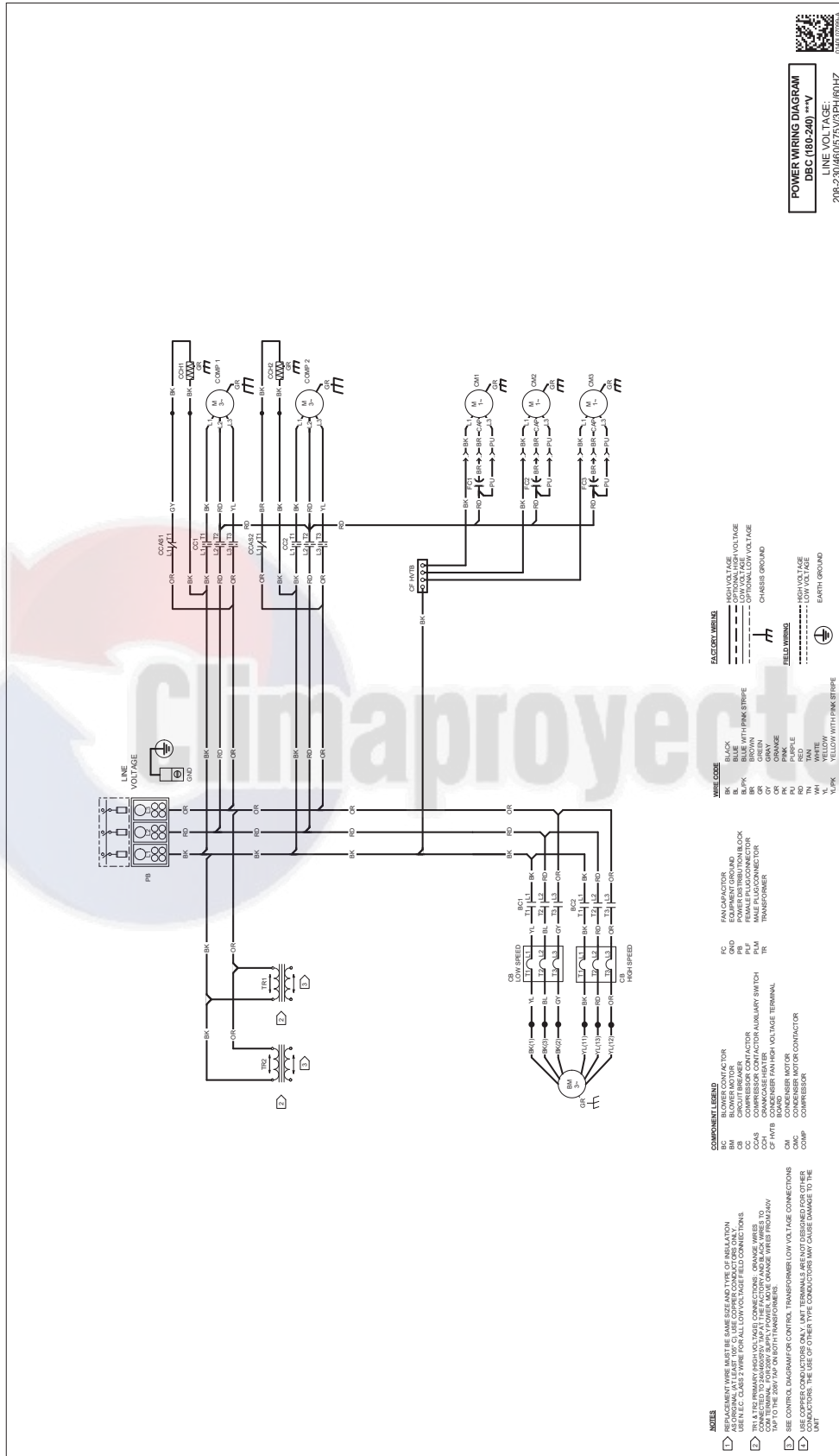

NOTES

- 1 REPLACEMENT WIRES MUST BE THE SAME SIZE AND TYPE OF INSULATION AS THE ORIGINAL WIRE.
- 2 USE ELEC CLASS 2 WIRE FOR ALL LOW VOLTAGE FIELD CONNECTIONS.
- 3 IN ALL PRIMARY/HIGH VOLTAGE CONNECTIONS, ORANGE WIRES TO COMBINATION TERMINALS, ORANGE WIRES TO COMBINATION TERMINALS, ORANGE WIRES TO COMBINATION TERMINALS, ORANGE WIRES TO COMBINATION TERMINALS.
- 4 USE CONTROL CABLES FOR CONTROL TRANSFORMERS. LOW VOLTAGE CONNECTIONS TO CONTROL TRANSFORMERS ONLY. UNIT TERMINALS ARE NOT DESIGNED FOR OTHER CONNECTIONS. THE USE OF OTHER TYPE CONDUCTORS MAY CAUSE DAMAGE TO THE UNIT.

COMPONENT LEGEND

- BK BREAKER
- BL BLU MOTOR
- BR BRN MOTOR
- BU BU MOTOR
- CA CONTACTOR
- CC COMPRESSOR CONTACTOR
- CO COIL
- CR COMPRESSOR CONTACTOR
- CT CONTACTOR
- OF IVTB
- OM COMPRESSOR MOTOR
- ON COMPRESSOR
- OR ORN MOTOR
- OS
- PH POWER DISTRIBUTION BLOCK
- PI POWER DISTRIBUTION BLOCK
- PLM MALE PLUG CONNECTOR
- TR TRANSFORMER
- YB YEL MOTOR
- YR YEL MOTOR

WIRE CODE

- BK BLACK
- BR BRN
- BU BU
- BLK BLK WITH PINK STRIPE
- BRN BRN
- GRN GRN
- GY GRAY
- PK PINK
- PU PURPLE
- RD RED
- TRN TRN
- YEL YELLOW
- YLPK YEL WITH PINK STRIPE

FACTORY WIRING

- HIGH VOLTAGE VOLTAGE
- LOW VOLTAGE VOLTAGE
- CHASSIS GROUND
- FIELD WIRING
- HIGH VOLTAGE
- LOW VOLTAGE
- EARTH GROUND

POWER WIRING DIAGRAM
DBC (180-240) *V**
 LINE VOLTAGE:
 208-230/480/575/3PH/60HZ

Wiring is subject to change. Always refer to the wiring diagram on the unit for the most up-to-date wiring.



WARNING

HIGH VOLTAGE!
 DISCONNECT ALL POWER BEFORE SERVICING OR INSTALLING THIS UNIT.
 MULTIPLE POWER SOURCES MAY BE PRESENT. FAILURE TO DO SO MAY
 CAUSE PROPERTY DAMAGE, PERSONAL INJURY OR DEATH.

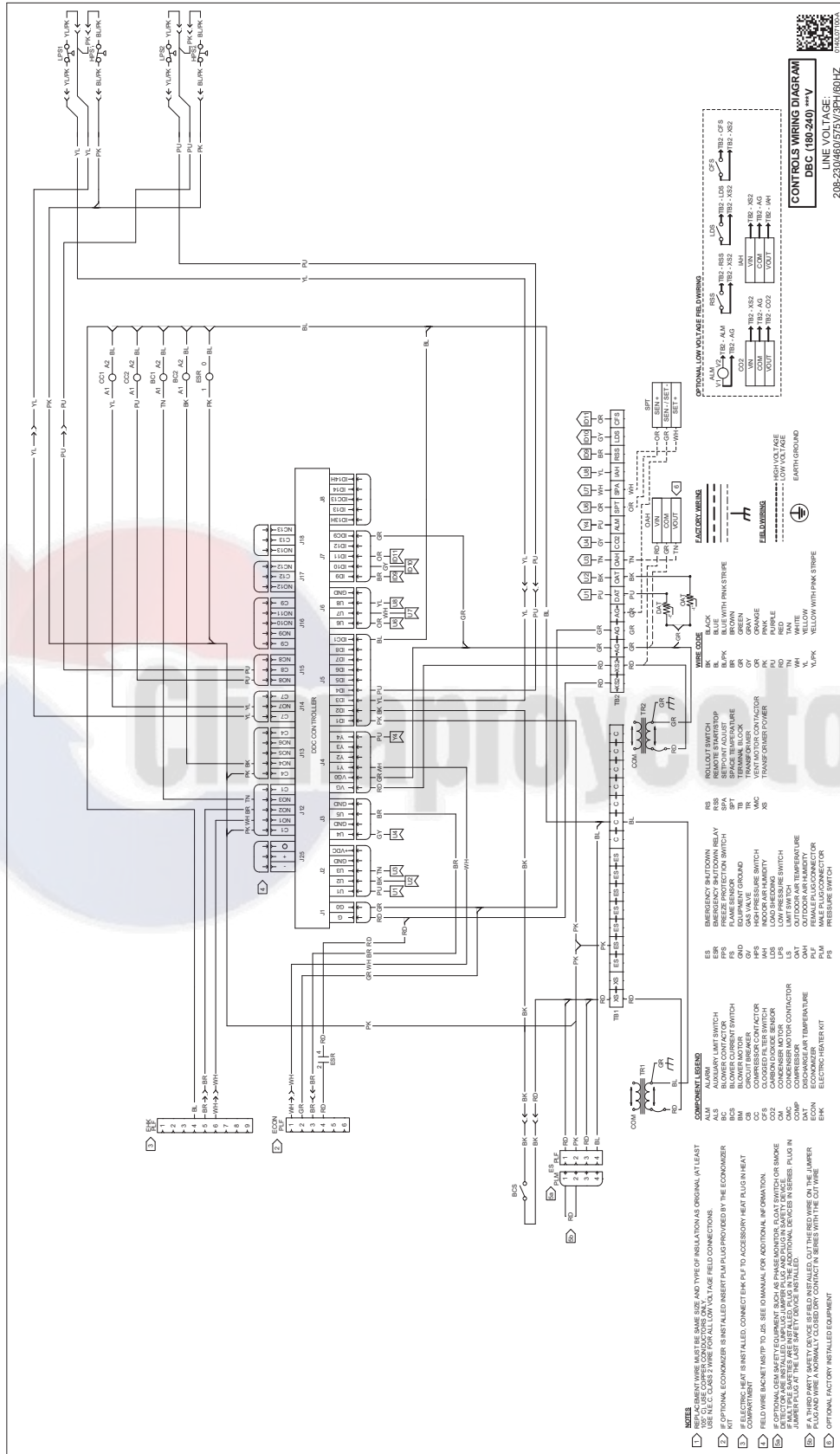

Wiring is subject to change. Always refer to the wiring diagram on the unit for the most up-to-date wiring.

HIGH VOLTAGE!
DISCONNECT ALL POWER BEFORE SERVICING OR INSTALLING THIS UNIT.
MULTIPLE POWER SOURCES MAY BE PRESENT. FAILURE TO DO SO MAY
CAUSE PROPERTY DAMAGE, PERSONAL INJURY OR DEATH.

WARNING



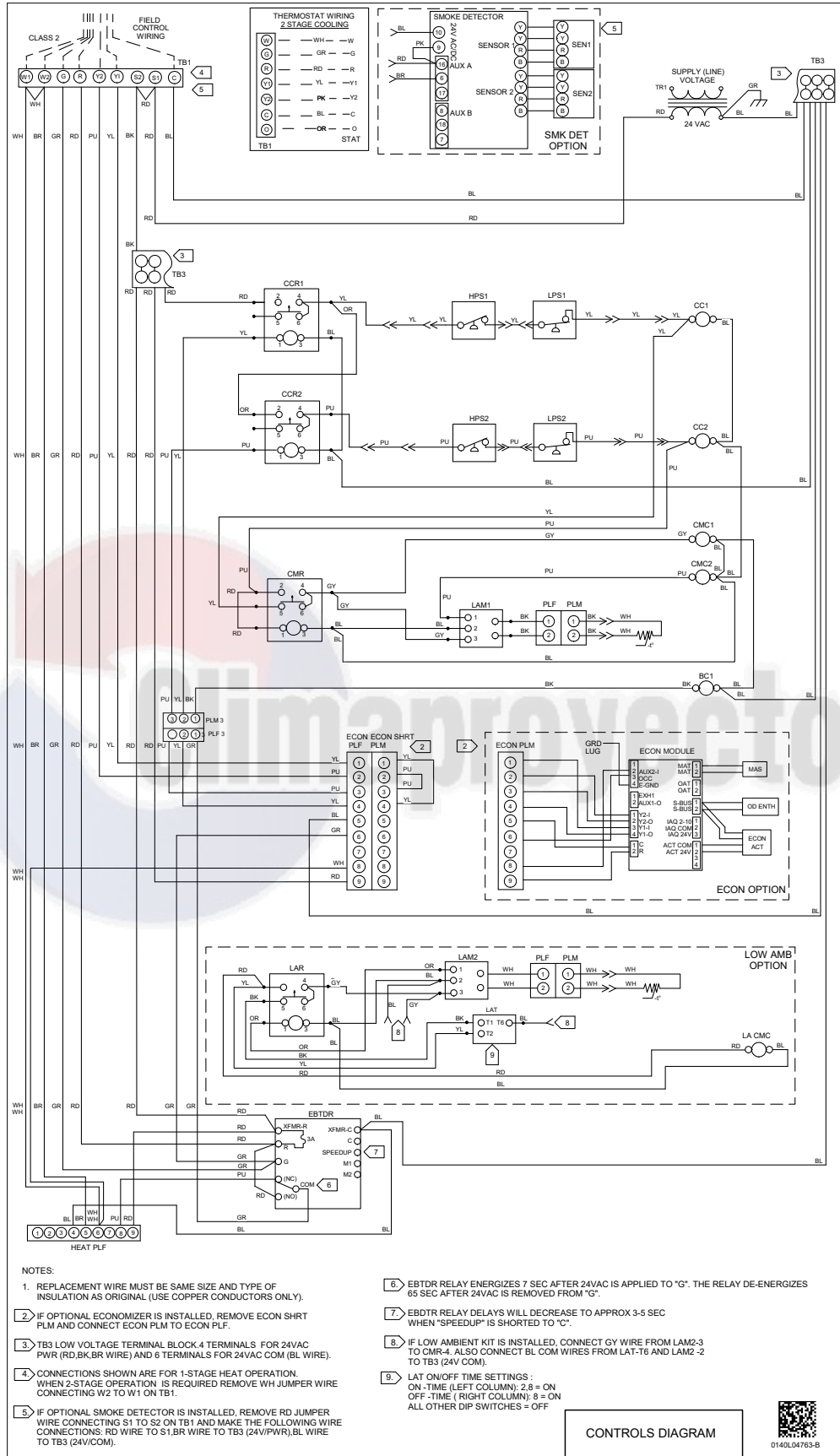

Wiring is subject to change. Always refer to the wiring diagram on the unit for the most up-to-date wiring.

UNIT WIRING DIAGRAMS

DBC300, 3PH 2 SPD, BELT

HIGH VOLTAGE!
DISCONNECT ALL POWER BEFORE SERVICING OR INSTALLING THIS UNIT.
MULTIPLE POWER SOURCES MAY BE PRESENT. FAILURE TO DO SO MAY
CAUSE PROPERTY DAMAGE, PERSONAL INJURY OR DEATH.

WARNING

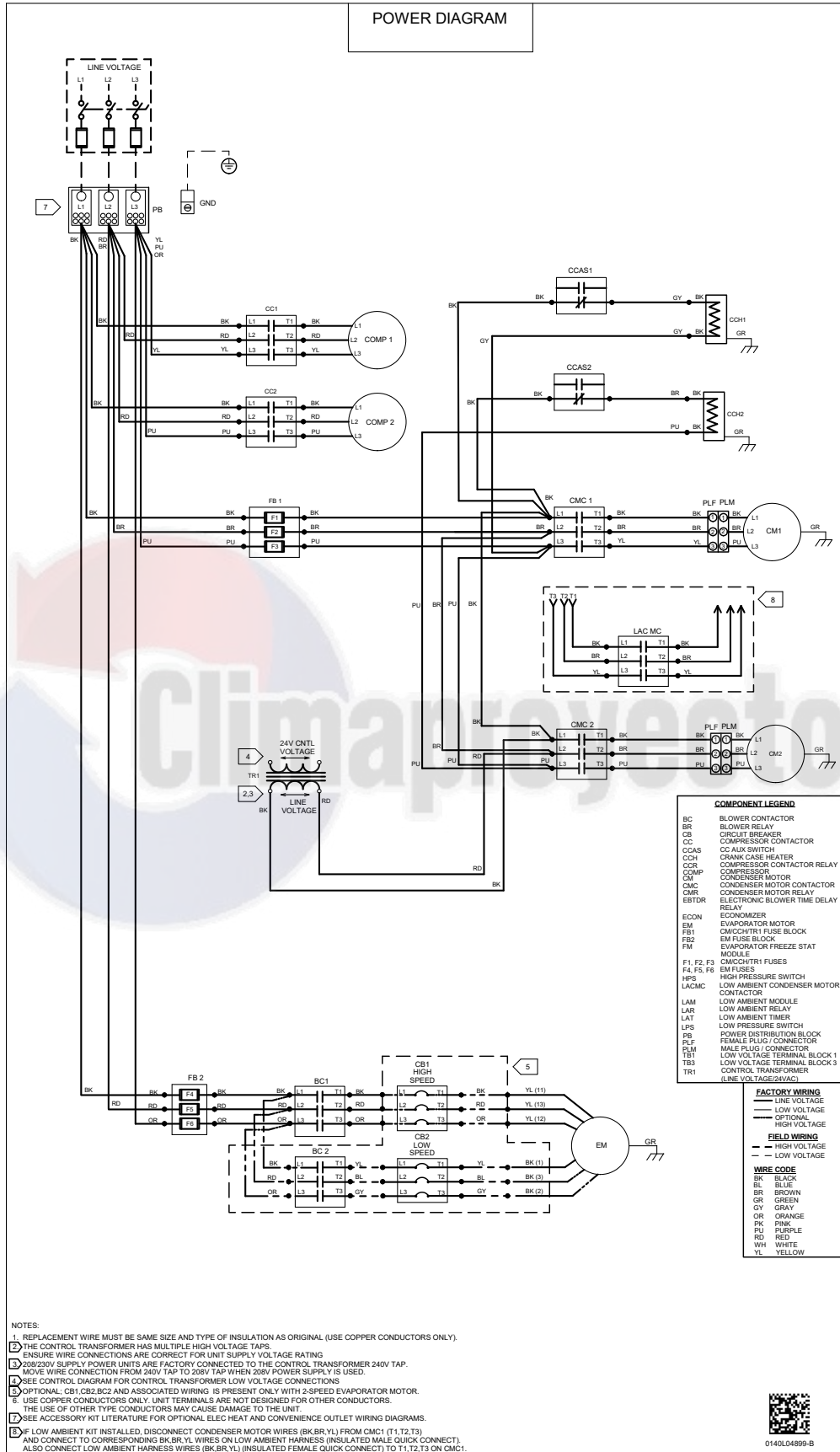

Wiring is subject to change. Always refer to the wiring diagram on the unit for the most up-to-date wiring.



WARNING

HIGH VOLTAGE!

DISCONNECT ALL POWER BEFORE SERVICING OR INSTALLING THIS UNIT.
MULTIPLE POWER SOURCES MAY BE PRESENT. FAILURE TO DO SO MAY
CAUSE PROPERTY DAMAGE, PERSONAL INJURY OR DEATH.



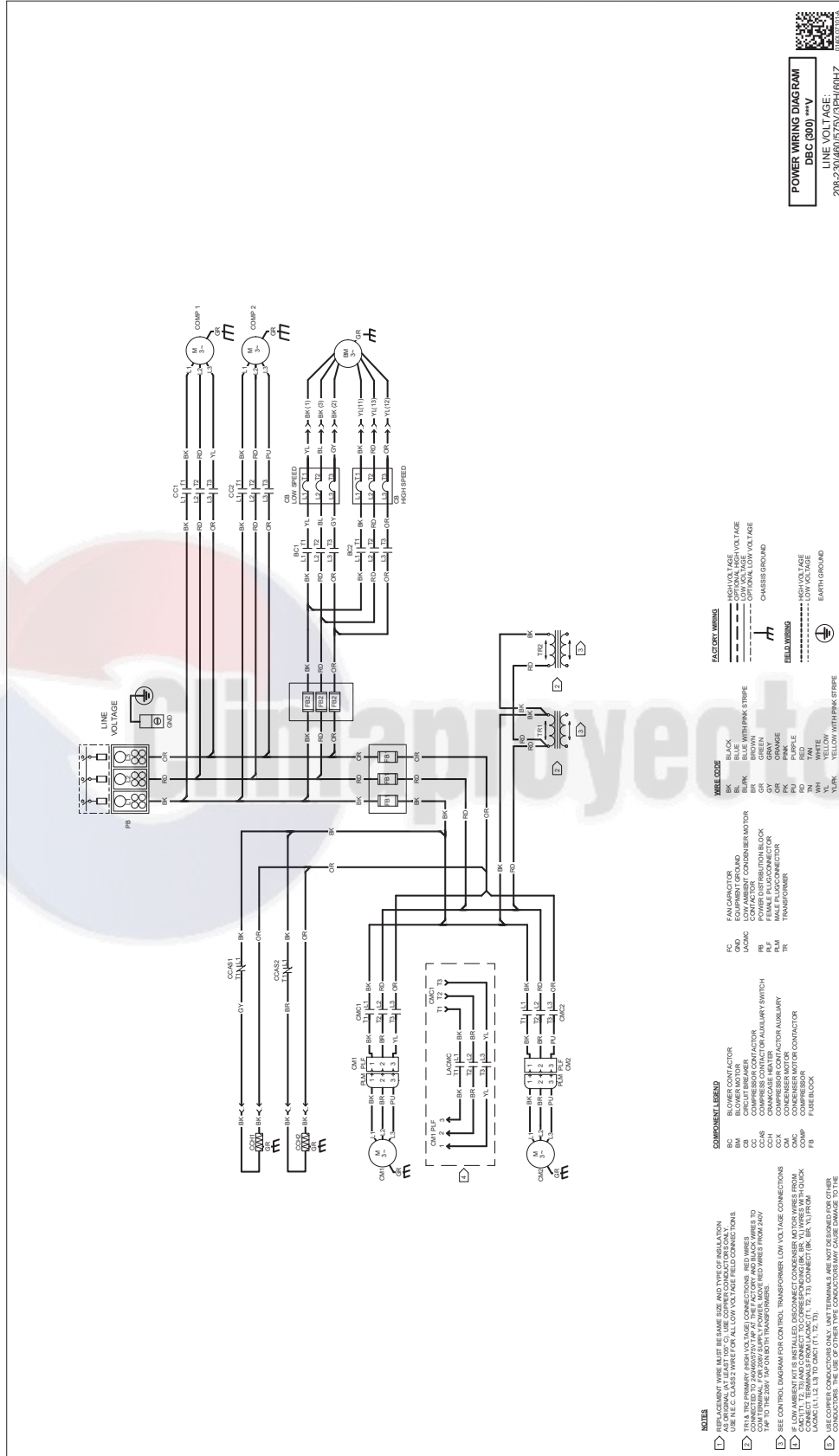

POWER WIRING DIAGRAM
DBC 300 3PH
 LINE VOLTAGE:
 208-230/480/575/3PH/60HZ

- NOTES**
- 1. REPLACEMENT WIRE MUST BE SAME SIZE AND TYPE OF INSULATION AS ORIGINAL. AT LEAST USE #14 AWG COPPER CONDUCTOR WIRE.
 - 2. TRIP TO PRIMARY HIGH VOLTAGE CONNECTIONS. RED WIRES TO BE CONNECTED TO TERMINAL PIP AT THE FACTORY AND BLACK WIRES TO BE CONNECTED TO TERMINAL PIP AT THE SERVICE. THIS WIRING IS FOR 240V TAP TO THE 2ND WAP ON BOTH TRANSFORMERS.
 - 3. SEE CONTROL DIAGRAM FOR CONTROL TRANSFORMER LOW VOLTAGE CONNECTIONS.
 - 4. LOW VOLTAGE MUST BE INSTALLED. DISCONNECT COMPRESSOR MOTOR WIRES FROM CONTACTOR (L1, L2, L3) AND FROM CONTACTOR (T1, T2, T3) CONNECT (BK, BR, YL) FROM CONTACTOR TO CONTACTOR.
 - 5. USE COPPER CONDUCTORS ONLY. UNIT TERMINALS ARE NOT DESIGNED FOR OTHER WIRE TYPES. THE USE OF OTHER WIRE TYPES OR CONDUCTORS MAY CAUSE DAMAGE TO THE UNIT.
- COMPONENT LEGEND**
- BC BLOWER CONTACTOR
 - BM BLOWER MOTOR
 - CC COMPRESSOR CONTACTOR
 - CC1 COMPRESSOR CAPACITOR
 - CC2 COMPRESSOR CAPACITOR
 - CCX COMPRESSOR CONTACTOR AUXILIARY
 - CMC COMPRESSOR MOTOR CONTACTOR
 - CP COMPRESSOR PUMP
 - FB FUSE BLOCK
 - FC FAN CONTACTOR
 - FM FAN MOTOR
 - LACM LAC MOTOR CONTACTOR
 - LACM1 LAC MOTOR CONTACTOR 1
 - LACM2 LAC MOTOR CONTACTOR 2
 - LACM3 LAC MOTOR CONTACTOR 3
 - LACM4 LAC MOTOR CONTACTOR 4
 - LACM5 LAC MOTOR CONTACTOR 5
 - LACM6 LAC MOTOR CONTACTOR 6
 - LACM7 LAC MOTOR CONTACTOR 7
 - LACM8 LAC MOTOR CONTACTOR 8
 - LACM9 LAC MOTOR CONTACTOR 9
 - LACM10 LAC MOTOR CONTACTOR 10
 - LACM11 LAC MOTOR CONTACTOR 11
 - LACM12 LAC MOTOR CONTACTOR 12
 - LACM13 LAC MOTOR CONTACTOR 13
 - LACM14 LAC MOTOR CONTACTOR 14
 - LACM15 LAC MOTOR CONTACTOR 15
 - LACM16 LAC MOTOR CONTACTOR 16
 - LACM17 LAC MOTOR CONTACTOR 17
 - LACM18 LAC MOTOR CONTACTOR 18
 - LACM19 LAC MOTOR CONTACTOR 19
 - LACM20 LAC MOTOR CONTACTOR 20
 - LACM21 LAC MOTOR CONTACTOR 21
 - LACM22 LAC MOTOR CONTACTOR 22
 - LACM23 LAC MOTOR CONTACTOR 23
 - LACM24 LAC MOTOR CONTACTOR 24
 - LACM25 LAC MOTOR CONTACTOR 25
 - LACM26 LAC MOTOR CONTACTOR 26
 - LACM27 LAC MOTOR CONTACTOR 27
 - LACM28 LAC MOTOR CONTACTOR 28
 - LACM29 LAC MOTOR CONTACTOR 29
 - LACM30 LAC MOTOR CONTACTOR 30
 - LACM31 LAC MOTOR CONTACTOR 31
 - LACM32 LAC MOTOR CONTACTOR 32
 - LACM33 LAC MOTOR CONTACTOR 33
 - LACM34 LAC MOTOR CONTACTOR 34
 - LACM35 LAC MOTOR CONTACTOR 35
 - LACM36 LAC MOTOR CONTACTOR 36
 - LACM37 LAC MOTOR CONTACTOR 37
 - LACM38 LAC MOTOR CONTACTOR 38
 - LACM39 LAC MOTOR CONTACTOR 39
 - LACM40 LAC MOTOR CONTACTOR 40
 - LACM41 LAC MOTOR CONTACTOR 41
 - LACM42 LAC MOTOR CONTACTOR 42
 - LACM43 LAC MOTOR CONTACTOR 43
 - LACM44 LAC MOTOR CONTACTOR 44
 - LACM45 LAC MOTOR CONTACTOR 45
 - LACM46 LAC MOTOR CONTACTOR 46
 - LACM47 LAC MOTOR CONTACTOR 47
 - LACM48 LAC MOTOR CONTACTOR 48
 - LACM49 LAC MOTOR CONTACTOR 49
 - LACM50 LAC MOTOR CONTACTOR 50
 - LACM51 LAC MOTOR CONTACTOR 51
 - LACM52 LAC MOTOR CONTACTOR 52
 - LACM53 LAC MOTOR CONTACTOR 53
 - LACM54 LAC MOTOR CONTACTOR 54
 - LACM55 LAC MOTOR CONTACTOR 55
 - LACM56 LAC MOTOR CONTACTOR 56
 - LACM57 LAC MOTOR CONTACTOR 57
 - LACM58 LAC MOTOR CONTACTOR 58
 - LACM59 LAC MOTOR CONTACTOR 59
 - LACM60 LAC MOTOR CONTACTOR 60
 - LACM61 LAC MOTOR CONTACTOR 61
 - LACM62 LAC MOTOR CONTACTOR 62
 - LACM63 LAC MOTOR CONTACTOR 63
 - LACM64 LAC MOTOR CONTACTOR 64
 - LACM65 LAC MOTOR CONTACTOR 65
 - LACM66 LAC MOTOR CONTACTOR 66
 - LACM67 LAC MOTOR CONTACTOR 67
 - LACM68 LAC MOTOR CONTACTOR 68
 - LACM69 LAC MOTOR CONTACTOR 69
 - LACM70 LAC MOTOR CONTACTOR 70
 - LACM71 LAC MOTOR CONTACTOR 71
 - LACM72 LAC MOTOR CONTACTOR 72
 - LACM73 LAC MOTOR CONTACTOR 73
 - LACM74 LAC MOTOR CONTACTOR 74
 - LACM75 LAC MOTOR CONTACTOR 75
 - LACM76 LAC MOTOR CONTACTOR 76
 - LACM77 LAC MOTOR CONTACTOR 77
 - LACM78 LAC MOTOR CONTACTOR 78
 - LACM79 LAC MOTOR CONTACTOR 79
 - LACM80 LAC MOTOR CONTACTOR 80
 - LACM81 LAC MOTOR CONTACTOR 81
 - LACM82 LAC MOTOR CONTACTOR 82
 - LACM83 LAC MOTOR CONTACTOR 83
 - LACM84 LAC MOTOR CONTACTOR 84
 - LACM85 LAC MOTOR CONTACTOR 85
 - LACM86 LAC MOTOR CONTACTOR 86
 - LACM87 LAC MOTOR CONTACTOR 87
 - LACM88 LAC MOTOR CONTACTOR 88
 - LACM89 LAC MOTOR CONTACTOR 89
 - LACM90 LAC MOTOR CONTACTOR 90
 - LACM91 LAC MOTOR CONTACTOR 91
 - LACM92 LAC MOTOR CONTACTOR 92
 - LACM93 LAC MOTOR CONTACTOR 93
 - LACM94 LAC MOTOR CONTACTOR 94
 - LACM95 LAC MOTOR CONTACTOR 95
 - LACM96 LAC MOTOR CONTACTOR 96
 - LACM97 LAC MOTOR CONTACTOR 97
 - LACM98 LAC MOTOR CONTACTOR 98
 - LACM99 LAC MOTOR CONTACTOR 99
 - LACM100 LAC MOTOR CONTACTOR 100
- WIRE CODES**
- BK BLACK
 - BR BROWN
 - BL BLUE
 - GY GRAY
 - PK PINK
 - PU PURPLE
 - TN TAN
 - YL YELLOW
 - YLK YELLOW WITH PINK STRIPE
- FACTORY WIRING**
- HIGH VOLTAGE
 - LOW VOLTAGE
 - OPTIONAL LOW VOLTAGE
 - CHASSIS GROUND
 - BELT WIRING
 - HIGH VOLTAGE
 - LOW VOLTAGE
 - EARTH GROUND

Wiring is subject to change. Always refer to the wiring diagram on the unit for the most up-to-date wiring.



WARNING

HIGH VOLTAGE!
 DISCONNECT ALL POWER BEFORE SERVICING OR INSTALLING THIS UNIT.
 MULTIPLE POWER SOURCES MAY BE PRESENT. FAILURE TO DO SO MAY
 CAUSE PROPERTY DAMAGE, PERSONAL INJURY OR DEATH.

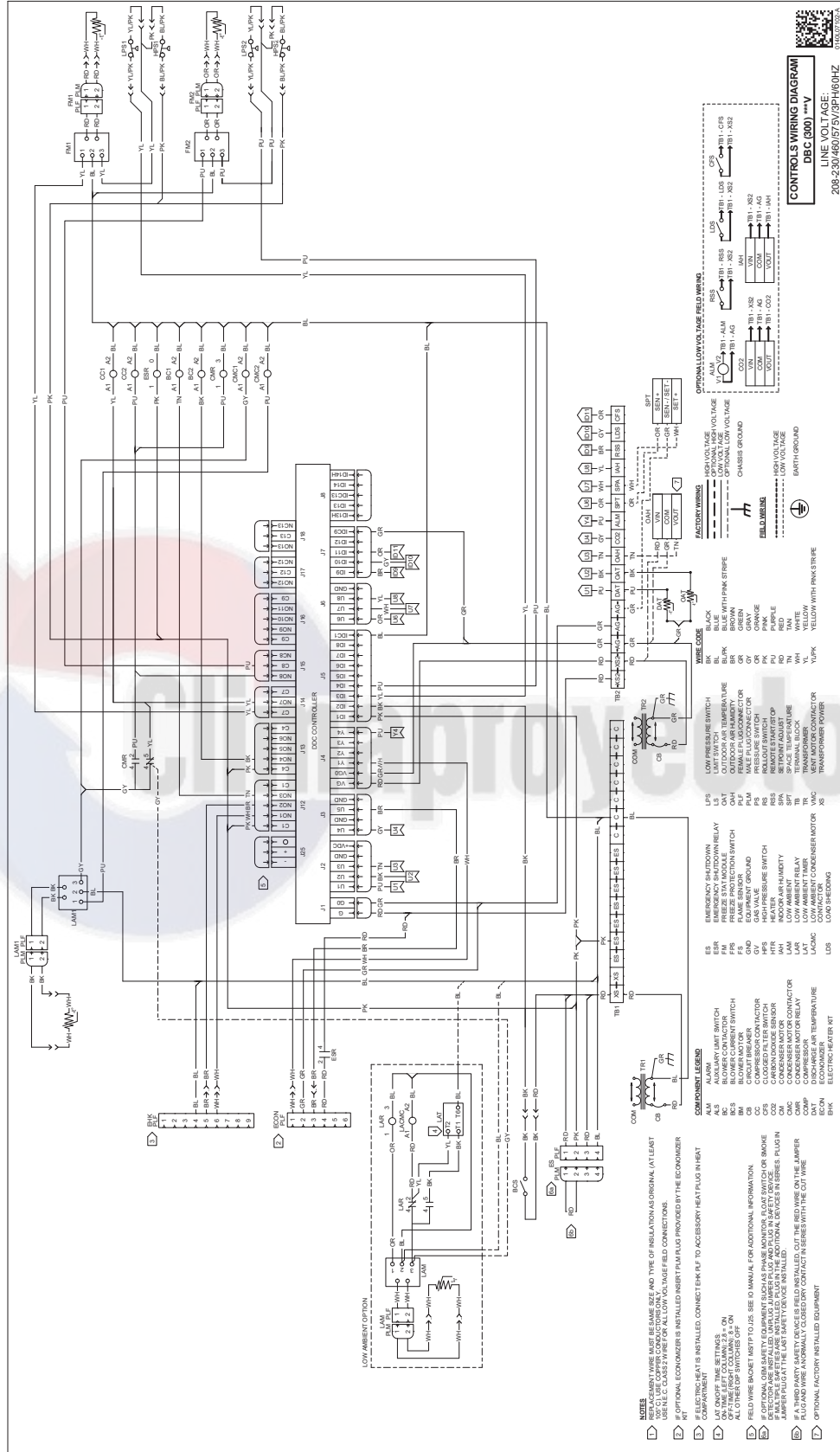

CONTROLS WIRING DIAGRAM
 LINE VOLTAGE:
 208-230/480/575V/3PH/60HZ

- NOTES:**
- 1. WIRE COLORS MUST BE THE SAME SIZE AND TYPE OF INSULATION AS ORIGINAL (AT LEAST 18 AWG). USE COPPER CONDUCTIONS ONLY.
 - 2. USE E.C. CLASS WIRE FOR ALL LOW VOLTAGE FIELD CONNECTIONS.
 - 3. OPTIONAL ECONOMIZER IS INSTALLED PER PLUG PROVIDED BY THE ECONOMIZER.
 - 4. IF ELECTRIC HEAT IS INSTALLED, CONNECT E.H.R.T. TO ACCESSORY HEAT PLUG IN HEAT ON THE LEFT COLUMN 2, 3 & 4 ON THE LEFT COLUMN 2, 3 & 4 ON THE LEFT SWITCHES OFF.
 - 5. FIELD WIRE BACNET M5P1P10J.R. SEE IO MANUAL FOR ADDITIONAL INFORMATION.
 - 6. FIELD WIRE BACNET M5P1P10J.R. SEE IO MANUAL FOR ADDITIONAL INFORMATION.
 - 7. FIELD WIRE BACNET M5P1P10J.R. SEE IO MANUAL FOR ADDITIONAL INFORMATION.
 - 8. FIELD WIRE BACNET M5P1P10J.R. SEE IO MANUAL FOR ADDITIONAL INFORMATION.
 - 9. FIELD WIRE BACNET M5P1P10J.R. SEE IO MANUAL FOR ADDITIONAL INFORMATION.
 - 10. FIELD WIRE BACNET M5P1P10J.R. SEE IO MANUAL FOR ADDITIONAL INFORMATION.
 - 11. FIELD WIRE BACNET M5P1P10J.R. SEE IO MANUAL FOR ADDITIONAL INFORMATION.
 - 12. FIELD WIRE BACNET M5P1P10J.R. SEE IO MANUAL FOR ADDITIONAL INFORMATION.
 - 13. FIELD WIRE BACNET M5P1P10J.R. SEE IO MANUAL FOR ADDITIONAL INFORMATION.
 - 14. FIELD WIRE BACNET M5P1P10J.R. SEE IO MANUAL FOR ADDITIONAL INFORMATION.
 - 15. FIELD WIRE BACNET M5P1P10J.R. SEE IO MANUAL FOR ADDITIONAL INFORMATION.
 - 16. FIELD WIRE BACNET M5P1P10J.R. SEE IO MANUAL FOR ADDITIONAL INFORMATION.
 - 17. FIELD WIRE BACNET M5P1P10J.R. SEE IO MANUAL FOR ADDITIONAL INFORMATION.
 - 18. FIELD WIRE BACNET M5P1P10J.R. SEE IO MANUAL FOR ADDITIONAL INFORMATION.
 - 19. FIELD WIRE BACNET M5P1P10J.R. SEE IO MANUAL FOR ADDITIONAL INFORMATION.
 - 20. FIELD WIRE BACNET M5P1P10J.R. SEE IO MANUAL FOR ADDITIONAL INFORMATION.
 - 21. FIELD WIRE BACNET M5P1P10J.R. SEE IO MANUAL FOR ADDITIONAL INFORMATION.
 - 22. FIELD WIRE BACNET M5P1P10J.R. SEE IO MANUAL FOR ADDITIONAL INFORMATION.
 - 23. FIELD WIRE BACNET M5P1P10J.R. SEE IO MANUAL FOR ADDITIONAL INFORMATION.
 - 24. FIELD WIRE BACNET M5P1P10J.R. SEE IO MANUAL FOR ADDITIONAL INFORMATION.
 - 25. FIELD WIRE BACNET M5P1P10J.R. SEE IO MANUAL FOR ADDITIONAL INFORMATION.
 - 26. FIELD WIRE BACNET M5P1P10J.R. SEE IO MANUAL FOR ADDITIONAL INFORMATION.
 - 27. FIELD WIRE BACNET M5P1P10J.R. SEE IO MANUAL FOR ADDITIONAL INFORMATION.
 - 28. FIELD WIRE BACNET M5P1P10J.R. SEE IO MANUAL FOR ADDITIONAL INFORMATION.
 - 29. FIELD WIRE BACNET M5P1P10J.R. SEE IO MANUAL FOR ADDITIONAL INFORMATION.
 - 30. FIELD WIRE BACNET M5P1P10J.R. SEE IO MANUAL FOR ADDITIONAL INFORMATION.
 - 31. FIELD WIRE BACNET M5P1P10J.R. SEE IO MANUAL FOR ADDITIONAL INFORMATION.
 - 32. FIELD WIRE BACNET M5P1P10J.R. SEE IO MANUAL FOR ADDITIONAL INFORMATION.
 - 33. FIELD WIRE BACNET M5P1P10J.R. SEE IO MANUAL FOR ADDITIONAL INFORMATION.
 - 34. FIELD WIRE BACNET M5P1P10J.R. SEE IO MANUAL FOR ADDITIONAL INFORMATION.
 - 35. FIELD WIRE BACNET M5P1P10J.R. SEE IO MANUAL FOR ADDITIONAL INFORMATION.
 - 36. FIELD WIRE BACNET M5P1P10J.R. SEE IO MANUAL FOR ADDITIONAL INFORMATION.
 - 37. FIELD WIRE BACNET M5P1P10J.R. SEE IO MANUAL FOR ADDITIONAL INFORMATION.
 - 38. FIELD WIRE BACNET M5P1P10J.R. SEE IO MANUAL FOR ADDITIONAL INFORMATION.
 - 39. FIELD WIRE BACNET M5P1P10J.R. SEE IO MANUAL FOR ADDITIONAL INFORMATION.
 - 40. FIELD WIRE BACNET M5P1P10J.R. SEE IO MANUAL FOR ADDITIONAL INFORMATION.
 - 41. FIELD WIRE BACNET M5P1P10J.R. SEE IO MANUAL FOR ADDITIONAL INFORMATION.
 - 42. FIELD WIRE BACNET M5P1P10J.R. SEE IO MANUAL FOR ADDITIONAL INFORMATION.
 - 43. FIELD WIRE BACNET M5P1P10J.R. SEE IO MANUAL FOR ADDITIONAL INFORMATION.
 - 44. FIELD WIRE BACNET M5P1P10J.R. SEE IO MANUAL FOR ADDITIONAL INFORMATION.
 - 45. FIELD WIRE BACNET M5P1P10J.R. SEE IO MANUAL FOR ADDITIONAL INFORMATION.
 - 46. FIELD WIRE BACNET M5P1P10J.R. SEE IO MANUAL FOR ADDITIONAL INFORMATION.
 - 47. FIELD WIRE BACNET M5P1P10J.R. SEE IO MANUAL FOR ADDITIONAL INFORMATION.
 - 48. FIELD WIRE BACNET M5P1P10J.R. SEE IO MANUAL FOR ADDITIONAL INFORMATION.
 - 49. FIELD WIRE BACNET M5P1P10J.R. SEE IO MANUAL FOR ADDITIONAL INFORMATION.
 - 50. FIELD WIRE BACNET M5P1P10J.R. SEE IO MANUAL FOR ADDITIONAL INFORMATION.
 - 51. FIELD WIRE BACNET M5P1P10J.R. SEE IO MANUAL FOR ADDITIONAL INFORMATION.
 - 52. FIELD WIRE BACNET M5P1P10J.R. SEE IO MANUAL FOR ADDITIONAL INFORMATION.
 - 53. FIELD WIRE BACNET M5P1P10J.R. SEE IO MANUAL FOR ADDITIONAL INFORMATION.
 - 54. FIELD WIRE BACNET M5P1P10J.R. SEE IO MANUAL FOR ADDITIONAL INFORMATION.
 - 55. FIELD WIRE BACNET M5P1P10J.R. SEE IO MANUAL FOR ADDITIONAL INFORMATION.
 - 56. FIELD WIRE BACNET M5P1P10J.R. SEE IO MANUAL FOR ADDITIONAL INFORMATION.
 - 57. FIELD WIRE BACNET M5P1P10J.R. SEE IO MANUAL FOR ADDITIONAL INFORMATION.
 - 58. FIELD WIRE BACNET M5P1P10J.R. SEE IO MANUAL FOR ADDITIONAL INFORMATION.
 - 59. FIELD WIRE BACNET M5P1P10J.R. SEE IO MANUAL FOR ADDITIONAL INFORMATION.
 - 60. FIELD WIRE BACNET M5P1P10J.R. SEE IO MANUAL FOR ADDITIONAL INFORMATION.
 - 61. FIELD WIRE BACNET M5P1P10J.R. SEE IO MANUAL FOR ADDITIONAL INFORMATION.
 - 62. FIELD WIRE BACNET M5P1P10J.R. SEE IO MANUAL FOR ADDITIONAL INFORMATION.
 - 63. FIELD WIRE BACNET M5P1P10J.R. SEE IO MANUAL FOR ADDITIONAL INFORMATION.
 - 64. FIELD WIRE BACNET M5P1P10J.R. SEE IO MANUAL FOR ADDITIONAL INFORMATION.
 - 65. FIELD WIRE BACNET M5P1P10J.R. SEE IO MANUAL FOR ADDITIONAL INFORMATION.
 - 66. FIELD WIRE BACNET M5P1P10J.R. SEE IO MANUAL FOR ADDITIONAL INFORMATION.
 - 67. FIELD WIRE BACNET M5P1P10J.R. SEE IO MANUAL FOR ADDITIONAL INFORMATION.
 - 68. FIELD WIRE BACNET M5P1P10J.R. SEE IO MANUAL FOR ADDITIONAL INFORMATION.
 - 69. FIELD WIRE BACNET M5P1P10J.R. SEE IO MANUAL FOR ADDITIONAL INFORMATION.
 - 70. FIELD WIRE BACNET M5P1P10J.R. SEE IO MANUAL FOR ADDITIONAL INFORMATION.
 - 71. FIELD WIRE BACNET M5P1P10J.R. SEE IO MANUAL FOR ADDITIONAL INFORMATION.
 - 72. FIELD WIRE BACNET M5P1P10J.R. SEE IO MANUAL FOR ADDITIONAL INFORMATION.
 - 73. FIELD WIRE BACNET M5P1P10J.R. SEE IO MANUAL FOR ADDITIONAL INFORMATION.
 - 74. FIELD WIRE BACNET M5P1P10J.R. SEE IO MANUAL FOR ADDITIONAL INFORMATION.
 - 75. FIELD WIRE BACNET M5P1P10J.R. SEE IO MANUAL FOR ADDITIONAL INFORMATION.
 - 76. FIELD WIRE BACNET M5P1P10J.R. SEE IO MANUAL FOR ADDITIONAL INFORMATION.
 - 77. FIELD WIRE BACNET M5P1P10J.R. SEE IO MANUAL FOR ADDITIONAL INFORMATION.
 - 78. FIELD WIRE BACNET M5P1P10J.R. SEE IO MANUAL FOR ADDITIONAL INFORMATION.
 - 79. FIELD WIRE BACNET M5P1P10J.R. SEE IO MANUAL FOR ADDITIONAL INFORMATION.
 - 80. FIELD WIRE BACNET M5P1P10J.R. SEE IO MANUAL FOR ADDITIONAL INFORMATION.
 - 81. FIELD WIRE BACNET M5P1P10J.R. SEE IO MANUAL FOR ADDITIONAL INFORMATION.
 - 82. FIELD WIRE BACNET M5P1P10J.R. SEE IO MANUAL FOR ADDITIONAL INFORMATION.
 - 83. FIELD WIRE BACNET M5P1P10J.R. SEE IO MANUAL FOR ADDITIONAL INFORMATION.
 - 84. FIELD WIRE BACNET M5P1P10J.R. SEE IO MANUAL FOR ADDITIONAL INFORMATION.
 - 85. FIELD WIRE BACNET M5P1P10J.R. SEE IO MANUAL FOR ADDITIONAL INFORMATION.
 - 86. FIELD WIRE BACNET M5P1P10J.R. SEE IO MANUAL FOR ADDITIONAL INFORMATION.
 - 87. FIELD WIRE BACNET M5P1P10J.R. SEE IO MANUAL FOR ADDITIONAL INFORMATION.
 - 88. FIELD WIRE BACNET M5P1P10J.R. SEE IO MANUAL FOR ADDITIONAL INFORMATION.
 - 89. FIELD WIRE BACNET M5P1P10J.R. SEE IO MANUAL FOR ADDITIONAL INFORMATION.
 - 90. FIELD WIRE BACNET M5P1P10J.R. SEE IO MANUAL FOR ADDITIONAL INFORMATION.
 - 91. FIELD WIRE BACNET M5P1P10J.R. SEE IO MANUAL FOR ADDITIONAL INFORMATION.
 - 92. FIELD WIRE BACNET M5P1P10J.R. SEE IO MANUAL FOR ADDITIONAL INFORMATION.
 - 93. FIELD WIRE BACNET M5P1P10J.R. SEE IO MANUAL FOR ADDITIONAL INFORMATION.
 - 94. FIELD WIRE BACNET M5P1P10J.R. SEE IO MANUAL FOR ADDITIONAL INFORMATION.
 - 95. FIELD WIRE BACNET M5P1P10J.R. SEE IO MANUAL FOR ADDITIONAL INFORMATION.
 - 96. FIELD WIRE BACNET M5P1P10J.R. SEE IO MANUAL FOR ADDITIONAL INFORMATION.
 - 97. FIELD WIRE BACNET M5P1P10J.R. SEE IO MANUAL FOR ADDITIONAL INFORMATION.
 - 98. FIELD WIRE BACNET M5P1P10J.R. SEE IO MANUAL FOR ADDITIONAL INFORMATION.
 - 99. FIELD WIRE BACNET M5P1P10J.R. SEE IO MANUAL FOR ADDITIONAL INFORMATION.
 - 100. FIELD WIRE BACNET M5P1P10J.R. SEE IO MANUAL FOR ADDITIONAL INFORMATION.

Wiring is subject to change. Always refer to the wiring diagram on the unit for the most up-to-date wiring.

DBH WIRING DIAGRAMS





WARNING

HIGH VOLTAGE!

DISCONNECT ALL POWER BEFORE SERVICING OR INSTALLING THIS UNIT.
MULTIPLE POWER SOURCES MAY BE PRESENT. FAILURE TO DO SO MAY
CAUSE PROPERTY DAMAGE, PERSONAL INJURY OR DEATH.

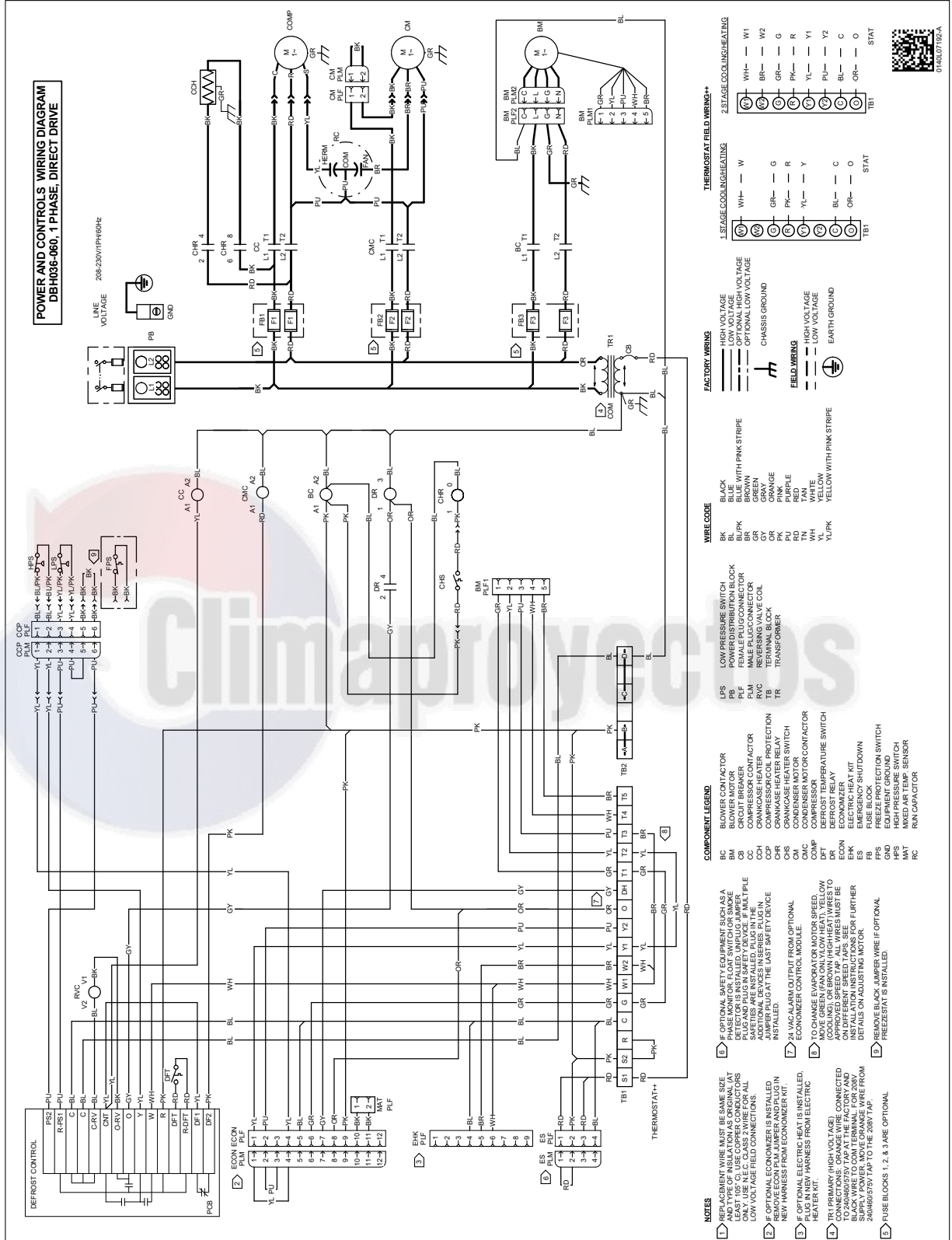

Wiring is subject to change. Always refer to the wiring diagram on the unit for the most up-to-date wiring.

WARNING

HIGH VOLTAGE!
 DISCONNECT ALL POWER BEFORE SERVICING OR INSTALLING THIS UNIT.
 MULTIPLE POWER SOURCES MAY BE PRESENT. FAILURE TO DO SO MAY
 CAUSE PROPERTY DAMAGE, PERSONAL INJURY OR DEATH.

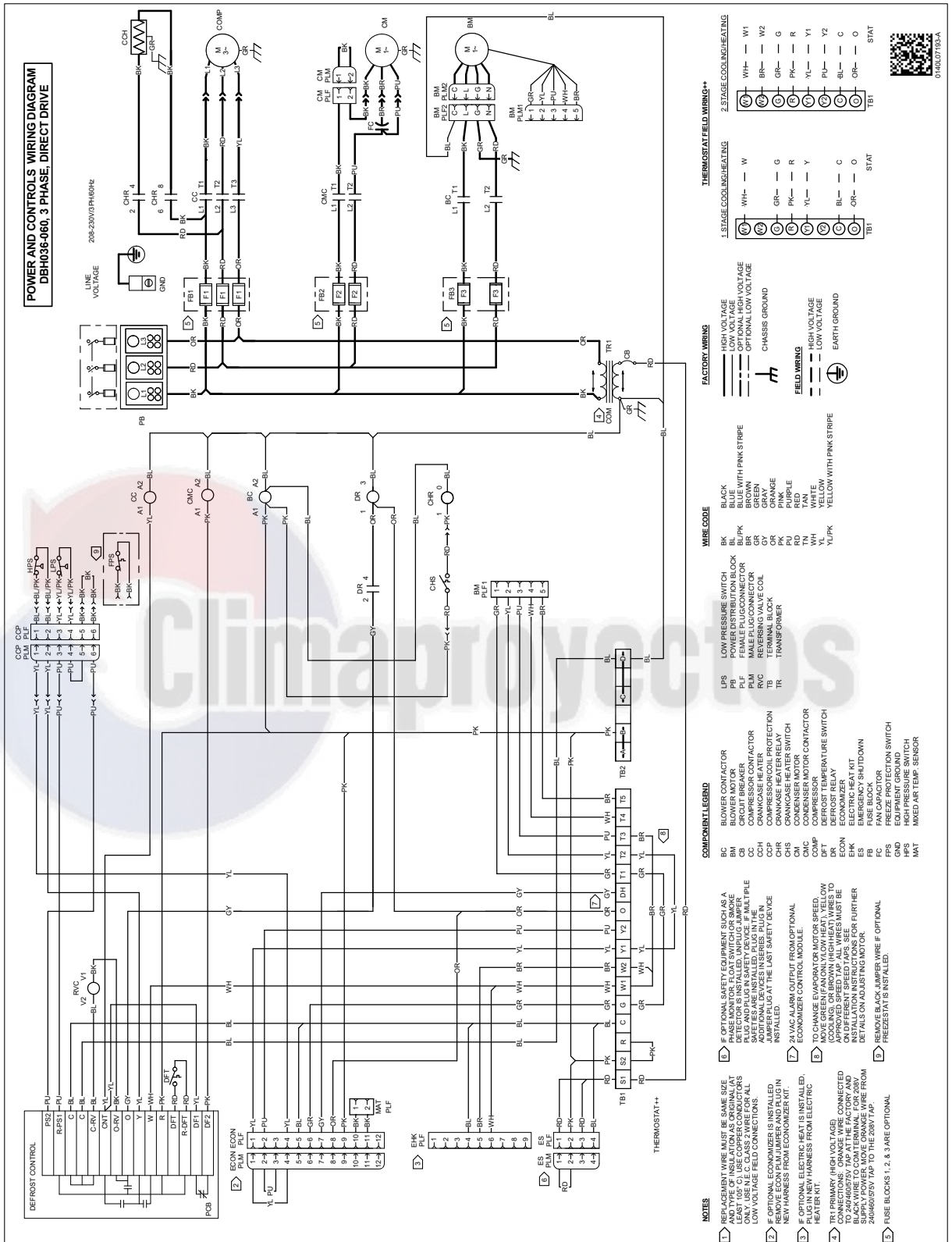

Wiring is subject to change. Always refer to the wiring diagram on the unit for the most up-to-date wiring.

WARNING
HIGH VOLTAGE!
 DISCONNECT ALL POWER BEFORE SERVICING OR INSTALLING THIS UNIT.
 MULTIPLE POWER SOURCES MAY BE PRESENT. FAILURE TO DO SO MAY
 CAUSE PROPERTY DAMAGE, PERSONAL INJURY OR DEATH.

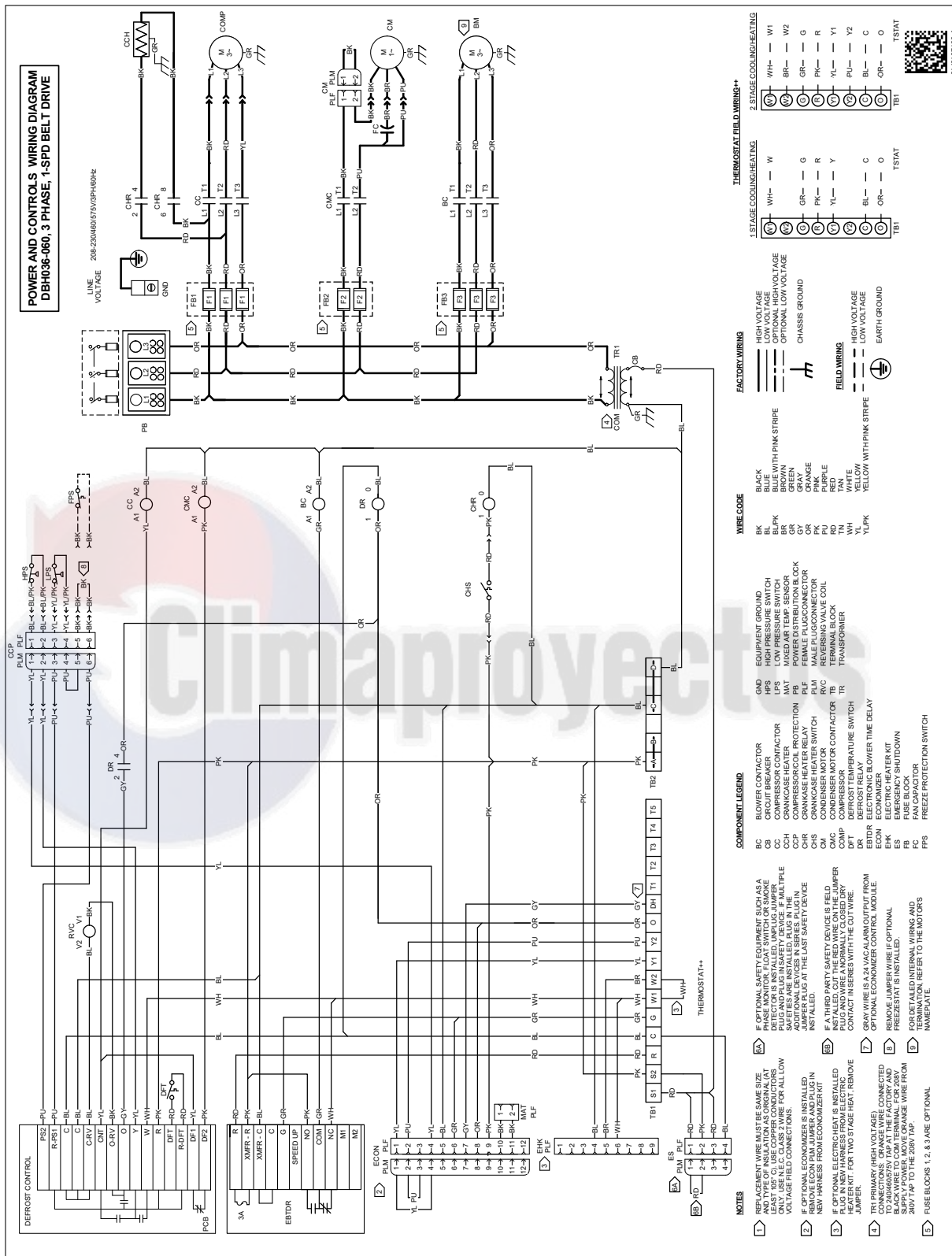

Wiring is subject to change. Always refer to the wiring diagram on the unit for the most up-to-date wiring.



WARNING

HIGH VOLTAGE!
 DISCONNECT ALL POWER BEFORE SERVICING OR INSTALLING THIS UNIT.
 MULTIPLE POWER SOURCES MAY BE PRESENT. FAILURE TO DO SO MAY
 CAUSE PROPERTY DAMAGE, PERSONAL INJURY OR DEATH.

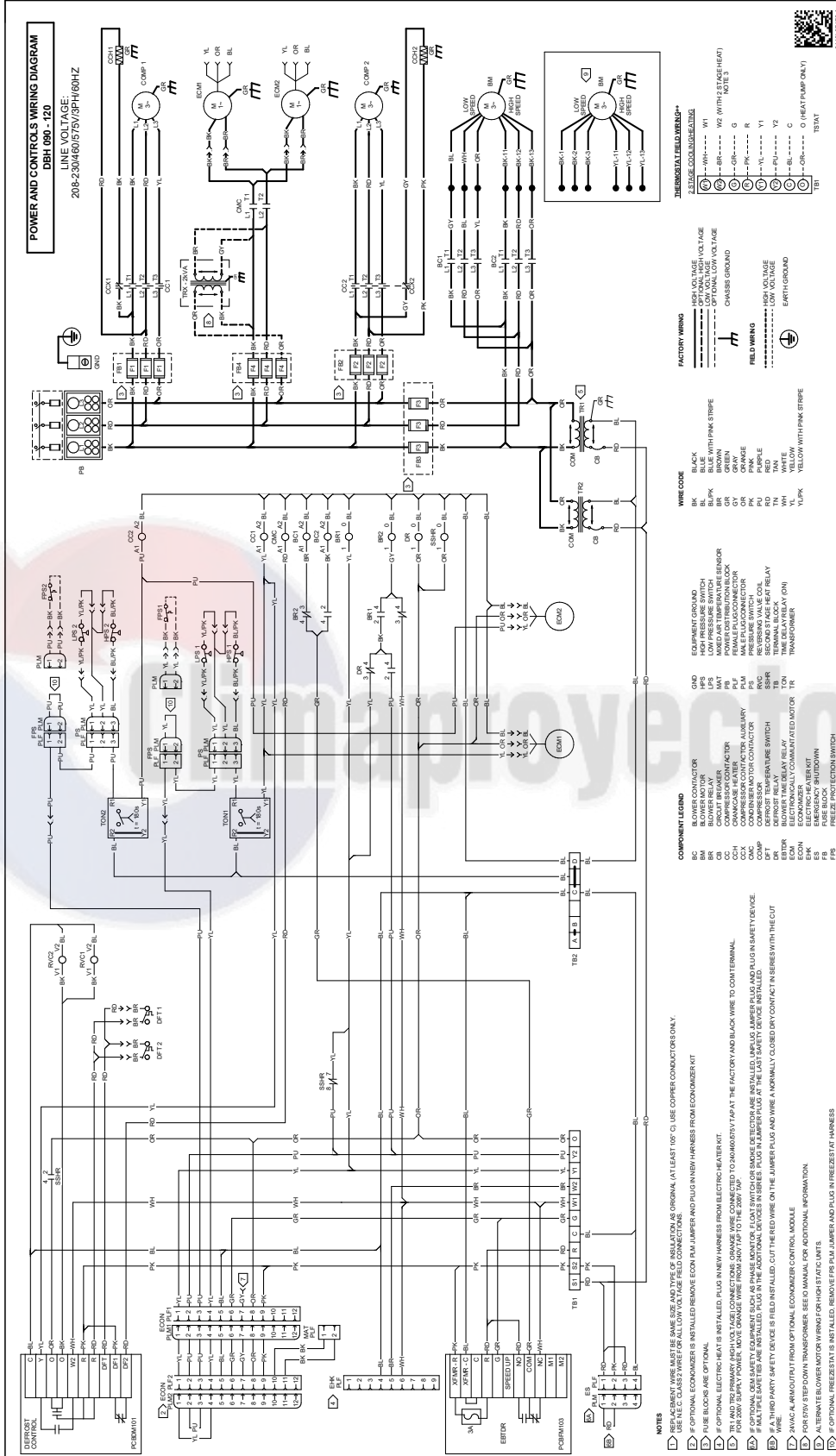

- NOTES**
1. WIRING MUST BE SAME AS TYPE OF INSTALLATION AS ORIGINAL. (AT LEAST 10' G) USE COPPER CONDUCTORS ONLY.
 2. USE N.E.C. CLASS WIRE OR ALLOW VOLTAGE RISE CONNECTIONS.
 3. IF OPTIONAL ECONOMIZER IS INSTALLED REMOVE ECON FAN JUMPER AND PLUG IN NEW WIRING FROM ECONOMIZER KIT.
 4. IF BLU BLOCS ARE OPTIONAL.
 5. IF OPTIONAL ELECTRIC HEAT IS INSTALLED, PLUG IN NEW WIRING FROM ELECTRIC HEATER KIT.
 6. SAFETY AND PROTECTIVE WIRING AND CONNECTIONS MUST BE COMPLETED TO 240/460V SYSTEM.
 7. IF SAFETY EQUIPMENT SUCH AS PHASE MONITOR, FLAT SWITCH OR SMOKE DETECTOR ARE INSTALLED, UNPLUG JUMPER PLUG AND PLUG IN SAFETY DEVICE.
 8. IF MULTIPLE SAFETY DEVICES ARE INSTALLED, PLUG IN THE ADDITIONAL DEVICES IN SERIES. PLUG IN JUMPER PLUG AT THE LAST SAFETY DEVICE INSTALLED.
 9. IF SAFETY EQUIPMENT SAFETY DEVICE IS FIELD INSTALLED, CUT THE RED WIRE ON THE JUMPER PLUG AND WIRE A NORMALLY CLOSED DRY CONTACT IN SERIES WITH THE CUT WIRE.
 10. SHACKLE ARMOUT FROM OPTIONAL ECONOMIZER CONTROL MODULE.
 11. FOR 55V STEP-DOWN TRANSFORMER, SEE IO MANUAL FOR ADDITIONAL INFORMATION.
 12. ALTERNATE BLOWER MOTOR WIRING FOR HIGH STATIC LIMITS.
 13. IF OPTIONAL FREEZE STAT IS INSTALLED, REMOVE FRS FAN JUMPER AND PLUG IN FREEZE STAT WIRING.

- COMPONENT LEGEND**
- BC BLOWER CONTACTOR
 - BR BLOWER RELAY
 - CB COMPRESSOR CONTACTOR
 - CH CHARGE HEATER
 - COH COIL HEATER
 - COM COMPRESSION MOTOR CONTACTOR
 - COMP COMPRESSOR
 - CON CONTROL BOARD
 - CR CRANKCASE HEATER
 - DR DRESSER RELAY
 - ECON ECONOMIZER
 - ECONN ECONOMIZER
 - ES EMERGENCY SHUTDOWN
 - FAN FAN MOTOR
 - FRS FREEZE PROTECTION SWITCH
 - HEAT HEATING ELEMENT
 - HEATN HEATING ELEMENT
 - HEATP HEATING ELEMENT
 - HEATY HEATING ELEMENT
 - HEATZ HEATING ELEMENT
 - HEAT3 HEATING ELEMENT
 - HEAT4 HEATING ELEMENT
 - HEAT5 HEATING ELEMENT
 - HEAT6 HEATING ELEMENT
 - HEAT7 HEATING ELEMENT
 - HEAT8 HEATING ELEMENT
 - HEAT9 HEATING ELEMENT
 - HEAT10 HEATING ELEMENT
 - HEAT11 HEATING ELEMENT
 - HEAT12 HEATING ELEMENT
 - HEAT13 HEATING ELEMENT
 - HEAT14 HEATING ELEMENT
 - HEAT15 HEATING ELEMENT
 - HEAT16 HEATING ELEMENT
 - HEAT17 HEATING ELEMENT
 - HEAT18 HEATING ELEMENT
 - HEAT19 HEATING ELEMENT
 - HEAT20 HEATING ELEMENT
 - HEAT21 HEATING ELEMENT
 - HEAT22 HEATING ELEMENT
 - HEAT23 HEATING ELEMENT
 - HEAT24 HEATING ELEMENT
 - HEAT25 HEATING ELEMENT
 - HEAT26 HEATING ELEMENT
 - HEAT27 HEATING ELEMENT
 - HEAT28 HEATING ELEMENT
 - HEAT29 HEATING ELEMENT
 - HEAT30 HEATING ELEMENT
 - HEAT31 HEATING ELEMENT
 - HEAT32 HEATING ELEMENT
 - HEAT33 HEATING ELEMENT
 - HEAT34 HEATING ELEMENT
 - HEAT35 HEATING ELEMENT
 - HEAT36 HEATING ELEMENT
 - HEAT37 HEATING ELEMENT
 - HEAT38 HEATING ELEMENT
 - HEAT39 HEATING ELEMENT
 - HEAT40 HEATING ELEMENT
 - HEAT41 HEATING ELEMENT
 - HEAT42 HEATING ELEMENT
 - HEAT43 HEATING ELEMENT
 - HEAT44 HEATING ELEMENT
 - HEAT45 HEATING ELEMENT
 - HEAT46 HEATING ELEMENT
 - HEAT47 HEATING ELEMENT
 - HEAT48 HEATING ELEMENT
 - HEAT49 HEATING ELEMENT
 - HEAT50 HEATING ELEMENT
 - HEAT51 HEATING ELEMENT
 - HEAT52 HEATING ELEMENT
 - HEAT53 HEATING ELEMENT
 - HEAT54 HEATING ELEMENT
 - HEAT55 HEATING ELEMENT
 - HEAT56 HEATING ELEMENT
 - HEAT57 HEATING ELEMENT
 - HEAT58 HEATING ELEMENT
 - HEAT59 HEATING ELEMENT
 - HEAT60 HEATING ELEMENT
 - HEAT61 HEATING ELEMENT
 - HEAT62 HEATING ELEMENT
 - HEAT63 HEATING ELEMENT
 - HEAT64 HEATING ELEMENT
 - HEAT65 HEATING ELEMENT
 - HEAT66 HEATING ELEMENT
 - HEAT67 HEATING ELEMENT
 - HEAT68 HEATING ELEMENT
 - HEAT69 HEATING ELEMENT
 - HEAT70 HEATING ELEMENT
 - HEAT71 HEATING ELEMENT
 - HEAT72 HEATING ELEMENT
 - HEAT73 HEATING ELEMENT
 - HEAT74 HEATING ELEMENT
 - HEAT75 HEATING ELEMENT
 - HEAT76 HEATING ELEMENT
 - HEAT77 HEATING ELEMENT
 - HEAT78 HEATING ELEMENT
 - HEAT79 HEATING ELEMENT
 - HEAT80 HEATING ELEMENT
 - HEAT81 HEATING ELEMENT
 - HEAT82 HEATING ELEMENT
 - HEAT83 HEATING ELEMENT
 - HEAT84 HEATING ELEMENT
 - HEAT85 HEATING ELEMENT
 - HEAT86 HEATING ELEMENT
 - HEAT87 HEATING ELEMENT
 - HEAT88 HEATING ELEMENT
 - HEAT89 HEATING ELEMENT
 - HEAT90 HEATING ELEMENT
 - HEAT91 HEATING ELEMENT
 - HEAT92 HEATING ELEMENT
 - HEAT93 HEATING ELEMENT
 - HEAT94 HEATING ELEMENT
 - HEAT95 HEATING ELEMENT
 - HEAT96 HEATING ELEMENT
 - HEAT97 HEATING ELEMENT
 - HEAT98 HEATING ELEMENT
 - HEAT99 HEATING ELEMENT
 - HEAT100 HEATING ELEMENT

- WIRE CODE**
- BLK BLACK
 - BLPK BLACK WITH PINK STRIPE
 - BRN BROWN
 - GRY GRAY
 - PKV PINK
 - PRP PURPLE
 - PUV PURPLE WITH VERTICAL STRIPE
 - TAN TAN
 - WHI WHITE
 - YEL YELLOW
 - YLPK YELLOW WITH PINK STRIPE

- FACTORY WIRING**
- HIGH VOLTAGE VOLTAGE
 - LOW VOLTAGE VOLTAGE
 - OPTIONAL LOW VOLTAGE
 - CHASSIS GROUND
- FIELD WIRING**
- HIGH VOLTAGE
 - LOW VOLTAGE
 - EARTH GROUND

- TERMINAL FIELD WIRING**
- W1
 - W2 (WITH 25 AMP HEAT)
 - W3
 - W4
 - W5
 - W6
 - W7
 - W8
 - W9
 - W10
 - W11
 - W12
 - W13
 - W14
 - W15
 - W16
 - W17
 - W18
 - W19
 - W20
 - W21
 - W22
 - W23
 - W24
 - W25
 - W26
 - W27
 - W28
 - W29
 - W30
 - W31
 - W32
 - W33
 - W34
 - W35
 - W36
 - W37
 - W38
 - W39
 - W40
 - W41
 - W42
 - W43
 - W44
 - W45
 - W46
 - W47
 - W48
 - W49
 - W50
 - W51
 - W52
 - W53
 - W54
 - W55
 - W56
 - W57
 - W58
 - W59
 - W60
 - W61
 - W62
 - W63
 - W64
 - W65
 - W66
 - W67
 - W68
 - W69
 - W70
 - W71
 - W72
 - W73
 - W74
 - W75
 - W76
 - W77
 - W78
 - W79
 - W80
 - W81
 - W82
 - W83
 - W84
 - W85
 - W86
 - W87
 - W88
 - W89
 - W90
 - W91
 - W92
 - W93
 - W94
 - W95
 - W96
 - W97
 - W98
 - W99
 - W100

- WIRE CODE**
- BLK BLACK
 - BLPK BLACK WITH PINK STRIPE
 - BRN BROWN
 - GRY GRAY
 - PKV PINK
 - PRP PURPLE
 - PUV PURPLE WITH VERTICAL STRIPE
 - TAN TAN
 - WHI WHITE
 - YEL YELLOW
 - YLPK YELLOW WITH PINK STRIPE

- COMPONENT LEGEND**
- BC BLOWER CONTACTOR
 - BR BLOWER RELAY
 - CB COMPRESSOR CONTACTOR
 - CH CHARGE HEATER
 - COH COIL HEATER
 - COM COMPRESSION MOTOR CONTACTOR
 - COMP COMPRESSOR
 - CON CONTROL BOARD
 - CR CRANKCASE HEATER
 - DR DRESSER RELAY
 - ECON ECONOMIZER
 - ECONN ECONOMIZER
 - ES EMERGENCY SHUTDOWN
 - FAN FAN MOTOR
 - FRS FREEZE PROTECTION SWITCH
 - HEAT HEATING ELEMENT
 - HEATN HEATING ELEMENT
 - HEATP HEATING ELEMENT
 - HEATY HEATING ELEMENT
 - HEATZ HEATING ELEMENT
 - HEAT3 HEATING ELEMENT
 - HEAT4 HEATING ELEMENT
 - HEAT5 HEATING ELEMENT
 - HEAT6 HEATING ELEMENT
 - HEAT7 HEATING ELEMENT
 - HEAT8 HEATING ELEMENT
 - HEAT9 HEATING ELEMENT
 - HEAT10 HEATING ELEMENT
 - HEAT11 HEATING ELEMENT
 - HEAT12 HEATING ELEMENT
 - HEAT13 HEATING ELEMENT
 - HEAT14 HEATING ELEMENT
 - HEAT15 HEATING ELEMENT
 - HEAT16 HEATING ELEMENT
 - HEAT17 HEATING ELEMENT
 - HEAT18 HEATING ELEMENT
 - HEAT19 HEATING ELEMENT
 - HEAT20 HEATING ELEMENT
 - HEAT21 HEATING ELEMENT
 - HEAT22 HEATING ELEMENT
 - HEAT23 HEATING ELEMENT
 - HEAT24 HEATING ELEMENT
 - HEAT25 HEATING ELEMENT
 - HEAT26 HEATING ELEMENT
 - HEAT27 HEATING ELEMENT
 - HEAT28 HEATING ELEMENT
 - HEAT29 HEATING ELEMENT
 - HEAT30 HEATING ELEMENT
 - HEAT31 HEATING ELEMENT
 - HEAT32 HEATING ELEMENT
 - HEAT33 HEATING ELEMENT
 - HEAT34 HEATING ELEMENT
 - HEAT35 HEATING ELEMENT
 - HEAT36 HEATING ELEMENT
 - HEAT37 HEATING ELEMENT
 - HEAT38 HEATING ELEMENT
 - HEAT39 HEATING ELEMENT
 - HEAT40 HEATING ELEMENT
 - HEAT41 HEATING ELEMENT
 - HEAT42 HEATING ELEMENT
 - HEAT43 HEATING ELEMENT
 - HEAT44 HEATING ELEMENT
 - HEAT45 HEATING ELEMENT
 - HEAT46 HEATING ELEMENT
 - HEAT47 HEATING ELEMENT
 - HEAT48 HEATING ELEMENT
 - HEAT49 HEATING ELEMENT
 - HEAT50 HEATING ELEMENT
 - HEAT51 HEATING ELEMENT
 - HEAT52 HEATING ELEMENT
 - HEAT53 HEATING ELEMENT
 - HEAT54 HEATING ELEMENT
 - HEAT55 HEATING ELEMENT
 - HEAT56 HEATING ELEMENT
 - HEAT57 HEATING ELEMENT
 - HEAT58 HEATING ELEMENT
 - HEAT59 HEATING ELEMENT
 - HEAT60 HEATING ELEMENT
 - HEAT61 HEATING ELEMENT
 - HEAT62 HEATING ELEMENT
 - HEAT63 HEATING ELEMENT
 - HEAT64 HEATING ELEMENT
 - HEAT65 HEATING ELEMENT
 - HEAT66 HEATING ELEMENT
 - HEAT67 HEATING ELEMENT
 - HEAT68 HEATING ELEMENT
 - HEAT69 HEATING ELEMENT
 - HEAT70 HEATING ELEMENT
 - HEAT71 HEATING ELEMENT
 - HEAT72 HEATING ELEMENT
 - HEAT73 HEATING ELEMENT
 - HEAT74 HEATING ELEMENT
 - HEAT75 HEATING ELEMENT
 - HEAT76 HEATING ELEMENT
 - HEAT77 HEATING ELEMENT
 - HEAT78 HEATING ELEMENT
 - HEAT79 HEATING ELEMENT
 - HEAT80 HEATING ELEMENT
 - HEAT81 HEATING ELEMENT
 - HEAT82 HEATING ELEMENT
 - HEAT83 HEATING ELEMENT
 - HEAT84 HEATING ELEMENT
 - HEAT85 HEATING ELEMENT
 - HEAT86 HEATING ELEMENT
 - HEAT87 HEATING ELEMENT
 - HEAT88 HEATING ELEMENT
 - HEAT89 HEATING ELEMENT
 - HEAT90 HEATING ELEMENT
 - HEAT91 HEATING ELEMENT
 - HEAT92 HEATING ELEMENT
 - HEAT93 HEATING ELEMENT
 - HEAT94 HEATING ELEMENT
 - HEAT95 HEATING ELEMENT
 - HEAT96 HEATING ELEMENT
 - HEAT97 HEATING ELEMENT
 - HEAT98 HEATING ELEMENT
 - HEAT99 HEATING ELEMENT
 - HEAT100 HEATING ELEMENT

- WIRE CODE**
- BLK BLACK
 - BLPK BLACK WITH PINK STRIPE
 - BRN BROWN
 - GRY GRAY
 - PKV PINK
 - PRP PURPLE
 - PUV PURPLE WITH VERTICAL STRIPE
 - TAN TAN
 - WHI WHITE
 - YEL YELLOW
 - YLPK YELLOW WITH PINK STRIPE

Wiring is subject to change. Always refer to the wiring diagram on the unit for the most up-to-date wiring.

DBG WIRING DIAGRAMS





WARNING

HIGH VOLTAGE!
DISCONNECT ALL POWER BEFORE SERVICING OR INSTALLING THIS UNIT.
MULTIPLE POWER SOURCES MAY BE PRESENT. FAILURE TO DO SO MAY
CAUSE PROPERTY DAMAGE, PERSONAL INJURY OR DEATH.

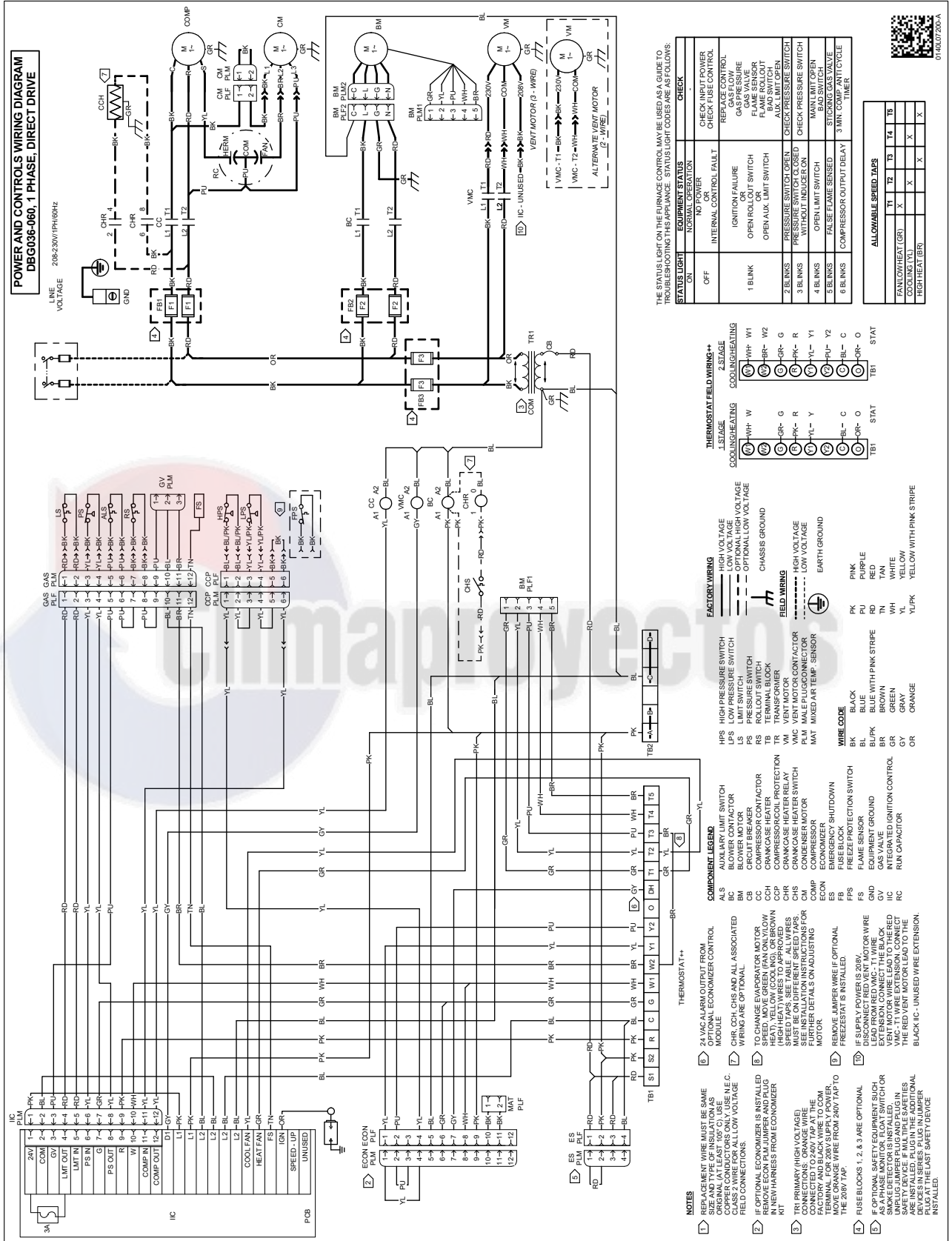

Wiring is subject to change. Always refer to the wiring diagram on the unit for the most up-to-date wiring.



WARNING

HIGH VOLTAGE!
 DISCONNECT ALL POWER BEFORE SERVICING OR INSTALLING THIS UNIT.
 MULTIPLE POWER SOURCES MAY BE PRESENT. FAILURE TO DO SO MAY
 CAUSE PROPERTY DAMAGE, PERSONAL INJURY OR DEATH.

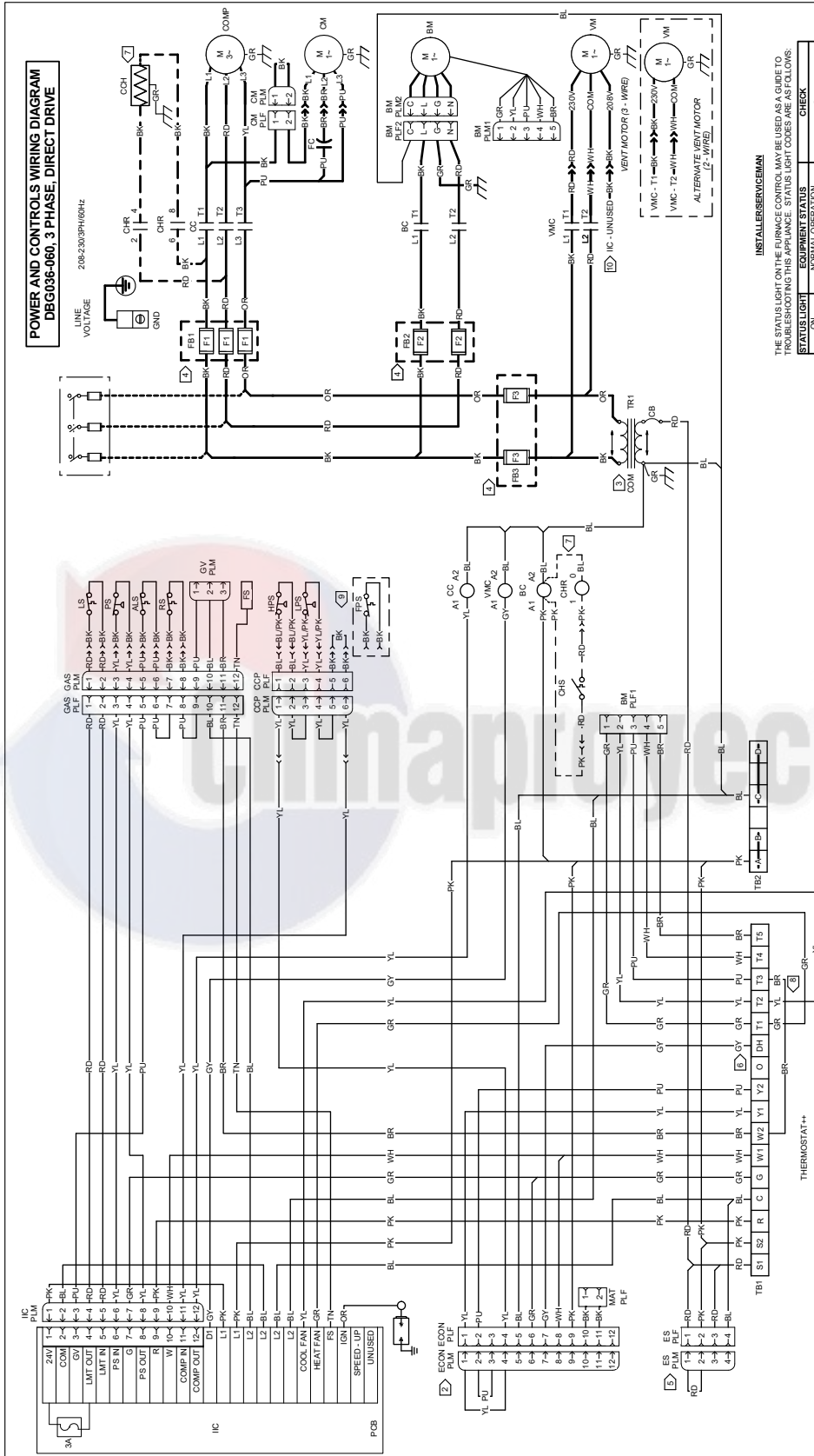

POWER AND CONTROLS WIRING DIAGRAM
 DBG036-060, 3 PHASE, DIRECT DRIVE

INSTALLER/SERVICEMAN

THE STATUS LIGHT ON THE FURNACE CONTROL MAY BE USED AS A GUIDE TO TROUBLESHOOTING THIS APPLIANCE. STATUS LIGHT CODES ARE AS FOLLOWS:

STATUS LIGHT	EQUIPMENT STATUS	CHECK
ON	NORMAL OPERATION	CHECK INPUT POWER
OFF	INTERNAL CONTROL FAILURE	CHECK FUSE CONTROL
1 BLINK	IGNITION FAILURE	REFUGES CONTROL
2 BLINKS	OPEN ROLLOUT SWITCH	GAS PRESSURE
3 BLINKS	OPEN AUX. LIMIT SWITCH	GAS PRESSURE
4 BLINKS	PRESSURE SWITCH CLOSED	FLAME ROLLOUT
5 BLINKS	WITHOUT INDUCER ON	AUX. LIMIT OPEN
6 BLINKS	FALSE FLAME SENSE	CHECK PRESSURE SWITCH
	COMPRESSOR OUTPUT DELAY	MANUAL LIMIT OPEN
	3 MIN. COOL DOWN	BAD SWITCH
	3 MIN. COOL DOWN	STORING GAS VALVE
	3 MIN. COOL DOWN	3 MIN. COOL DOWN
	3 MIN. COOL DOWN	3 MIN. COOL DOWN

THERMOSTAT FIELD WIRING**

TERMINAL	WIRE COLOR	FUNCTION
W1	WH	HEATING
W2	BR	COOLING
G	GR	COMMON
R	RD	REVERSE
Y1	YL	Y1 COOLING
Y2	YC	Y2 COOLING
O	OR	OFF
STAT	PK	STATUS

FACTORY WIRING

LOW VOLTAGE
 OPTIONAL HIGH VOLTAGE
 OPTIONAL LOW VOLTAGE
 CHASSIS GROUND

FIELD WIRING

HIGH VOLTAGE
 LOW VOLTAGE
 EARTH GROUND

WIRE CODE

PK	BLACK
BL	BLUE
BR	BROWN
GR	GREEN
GY	GRAY
OR	ORANGE
PU	PURPLE
RD	RED
WH	WHITE
YL	YELLOW
YLPK	YELLOW WITH PINK STRIPE

COMPONENT LEGEND

ALS	AUXILIARY LIMIT SWITCH
BLM	BLOWER MOTOR
CB	CIRCUIT BREAKER
CC	COMPRESSOR CONTACTOR
CHS	CRANKCASE HEATER
CHR	CRANKCASE HEATER PROTECTION
CHS	CRANKCASE HEATER SWITCH
CM	COMPRESSOR MOTOR
COMP	COMPRESSOR
CON	CONNECTION
ES	EMERGENCY SHUTDOWN
F	FUSE BLOCK
FC	FAN CAPACITOR
FS	FLAME SENSOR
GND	EQUIPMENT GROUND
GV	GAS VALVE
IC	INTEGRATED IGNITION CONTROL

- NOTES**
- REPLACEMENT WIRE MUST BE THE SAME SIZE AS THE ORIGINAL. USE COPPER CONDUCTORS AT LEAST 18 AWG. USE COPPER CONDUCTORS FOR ALL LOW VOLTAGE FIELD CONNECTIONS.
 - IF OPTIONAL ECONOMIZER IS INSTALLED, THE ECONOMIZER WIRE MUST BE CONNECTED TO 240V TAP AT THE FACTORY. APPROVED SPEED TAPS, SEE TABLE. 208V SUPPLY POWER MOVE ORANGE WIRE FROM 208V TAP TO THE 208V TAP.
 - FUSE BLOCKS 1, 2 & 3 ARE OPTIONAL. FREEZE JUMPER WIRE IF OPTIONAL.
 - IF SUPPLY POWER IS 208V, DISCONNECTED VENT MOTOR WIRE EXTENSION, CONNECT THE BLACK WIRE TO THE SUPPLY POWER. THE NEXT MOTOR LEAD TO THE BLACK WIRE EXTENSION.
 - IF SUPPLY POWER IS 208V, DISCONNECTED VENT MOTOR WIRE EXTENSION, CONNECT THE BLACK WIRE TO THE SUPPLY POWER. THE NEXT MOTOR LEAD TO THE BLACK WIRE EXTENSION.

Wiring is subject to change. Always refer to the wiring diagram on the unit for the most up-to-date wiring.

WARNING

HIGH VOLTAGE!

DISCONNECT ALL POWER BEFORE SERVICING OR INSTALLING THIS UNIT.
MULTIPLE POWER SOURCES MAY BE PRESENT. FAILURE TO DO SO MAY
CAUSE PROPERTY DAMAGE, PERSONAL INJURY OR DEATH.



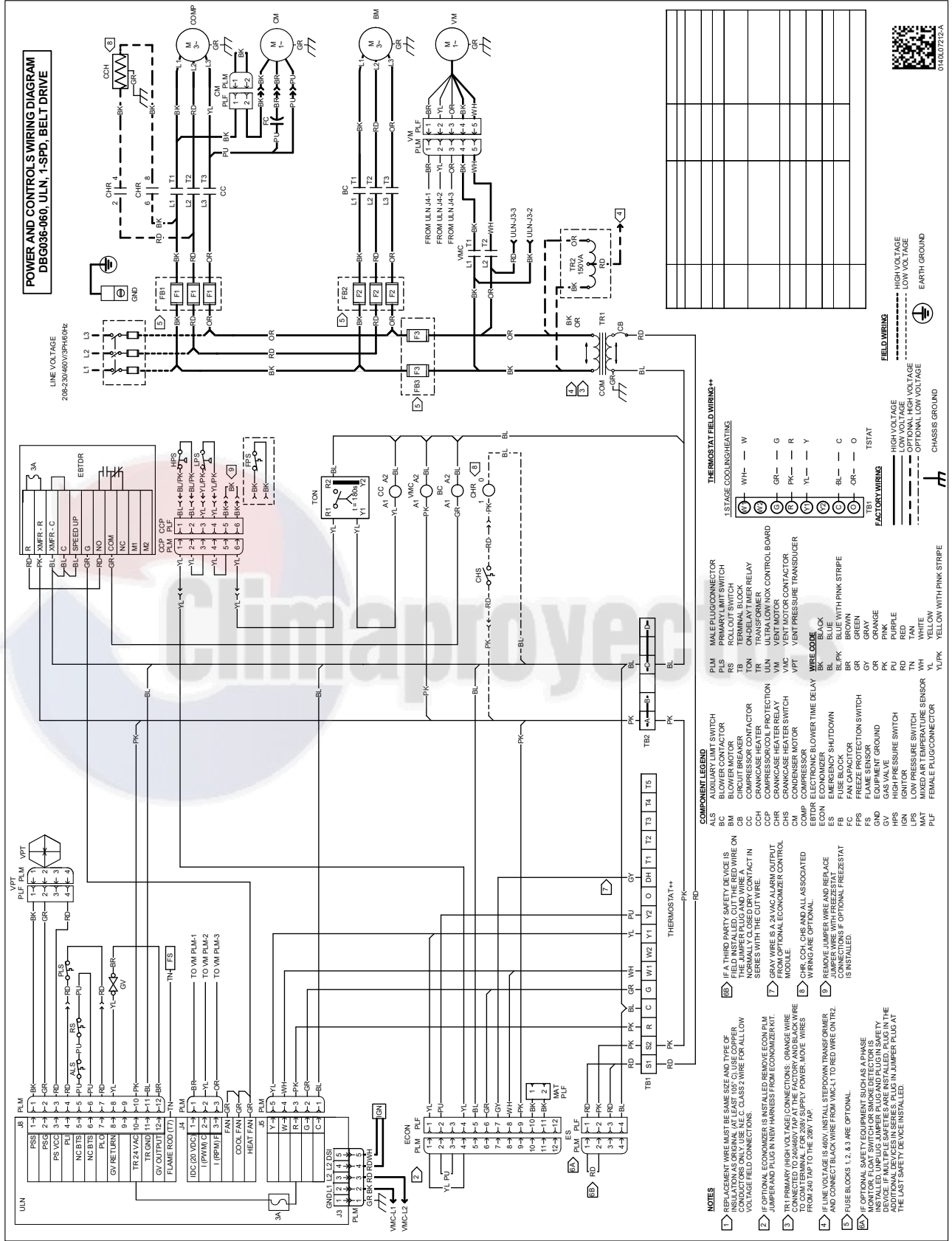

Wiring is subject to change. Always refer to the wiring diagram on the unit for the most up-to-date wiring.



WARNING

HIGH VOLTAGE!
 DISCONNECT ALL POWER BEFORE SERVICING OR INSTALLING THIS UNIT.
 MULTIPLE POWER SOURCES MAY BE PRESENT. FAILURE TO DO SO MAY
 CAUSE PROPERTY DAMAGE, PERSONAL INJURY OR DEATH.

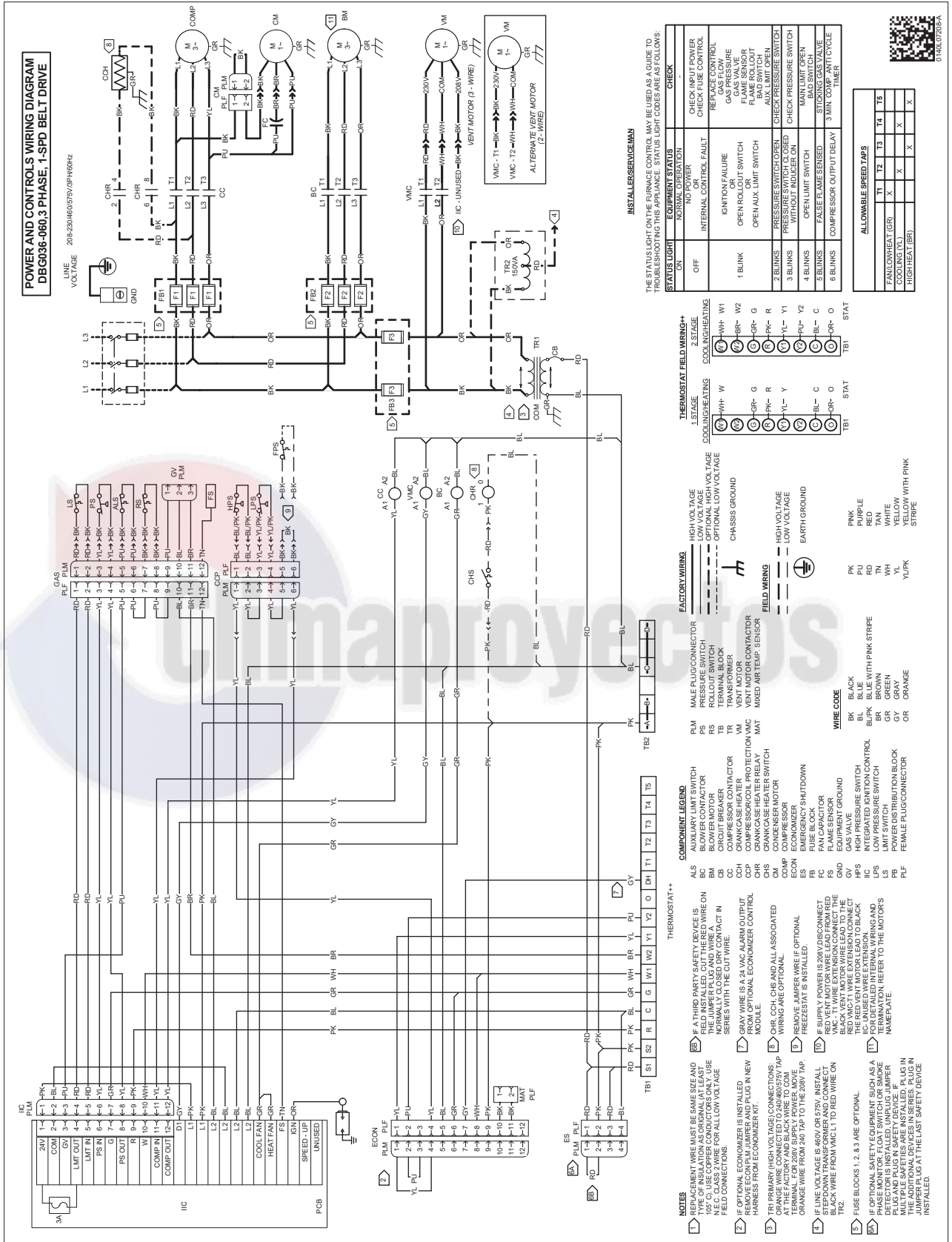

Wiring is subject to change. Always refer to the wiring diagram on the unit for the most up-to-date wiring.

WARNING

HIGH VOLTAGE!
DISCONNECT ALL POWER BEFORE SERVICING OR INSTALLING THIS UNIT.
MULTIPLE POWER SOURCES MAY BE PRESENT. FAILURE TO DO SO MAY
CAUSE PROPERTY DAMAGE, PERSONAL INJURY OR DEATH.

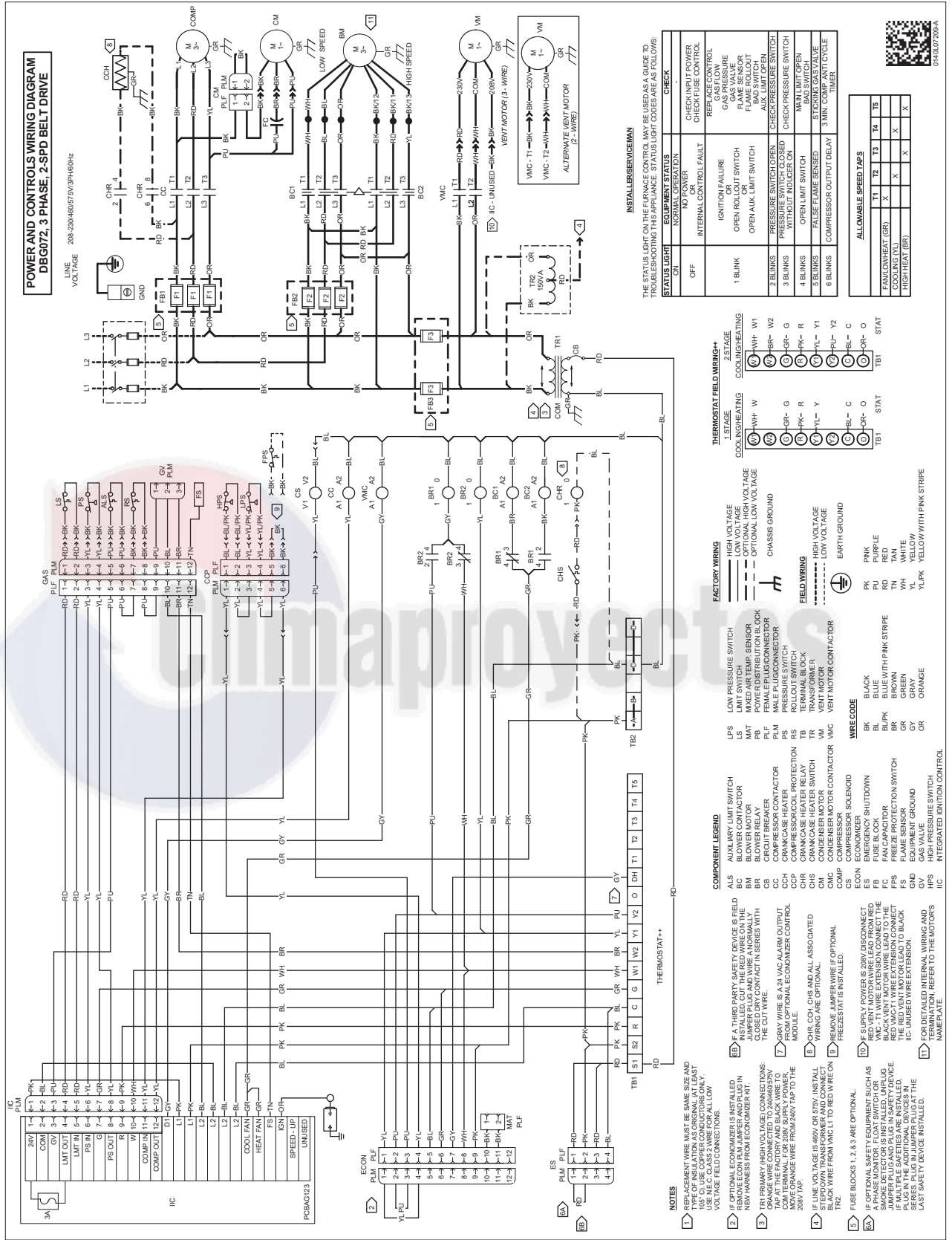

POWER AND CONTROLS WIRING DIAGRAM
DBG072, 3 PHASE, 2-SPD BELT DRIVE

INSTALLER SERVICE MAN
THE STATUS LIGHT ON THE FURNACE CONTROL MAY BE USED AS A GUIDE TO TROUBLESHOOTING THIS APPLIANCE. STATUS LIGHT CODES ARE AS FOLLOWS:

STATUS LIGHT	EQUIPMENT STATUS	CHECK
ON	NO POWER	CHECK MAIN POWER
OFF	NO POWER	CHECK FUSE CONTROL
1 BLINK	INTERNAL CONTROL FAULT	REPLACE CONTROL
2 BLINKS	IGNITION FAILURE	GAS FLOW
3 BLINKS	OPEN ROLLOUT SWITCH	GAS PRESSURE
4 BLINKS	OPEN AUX. LIMIT SWITCH	FLAME SENSOR
5 BLINKS	PRESSURE SWITCH OPEN	FLAME ROLLOUT
6 BLINKS	PHASE SEQUENCE	FLAME ROLLOUT
7 BLINKS	OPEN LIMIT SWITCH	ALX. LIMIT OPEN
8 BLINKS	FALSE FLAME SENSE	CHECK PRESSURE SWITCH
9 BLINKS	COMPRESSOR OUTLET DELAY	MANUAL LIMIT OPEN
		3 MIN. COMP. ANTICYCLE
		TIMER

ALLOWABLE SPEED RATES

	T1	T2	T3	T4	T5
FAN/COOLHEAT (GR)	X	X	X	X	X
COOLING (YL)	X	X	X	X	X
HIGH HEAT (BR)	X	X	X	X	X

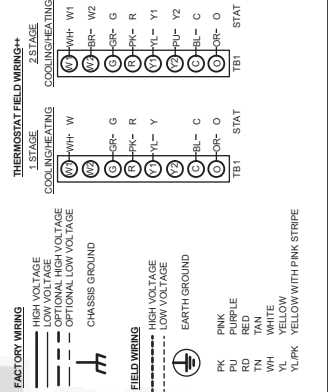

COMPONENT LEGEND

ALIAS	DESCRIPTION
ALS	AUXILIARY LIMIT SWITCH
AM	MIXED AIR TEMP. SENSOR
BM	BLOWER MOTOR
CB	CIRCUIT BREAKER
CC	COMPRESSOR CONTACTOR
CH	CRANKCASE HEATER
CHR	CRANKCASE HEATER RELAY
CHS	CRANKCASE HEATER SWITCH
CM	CONDENSER MOTOR
COMP	COMPRESSOR MOTOR CONTACTOR
CS	COMPRESSOR SOLENOID
ECON	ECONOMIZER
ES	EMERGENCY SHUTDOWN
FC	FAN CAPACITOR
FS	FREEZE PROTECTION SWITCH
FS	FLAME SENSOR
GV	GAS VALVE
HPS	HIGH PRESSURE SWITCH
IIC	INTEGRATED IGNITION CONTROL

NOTES

- REPLACE WIRE MUST BE SAME SIZE AND TYPE OF INSULATION AS ORIGINAL AT LEAST 105°C USE COPPER CONDUCTORS ONLY. VOLTAGE FIELD CONNECTIONS.
- IF A THIRD PARTY SAFETY DEVICE IS FIELD INSTALLED, CUT THE RED WIRE ON THE JUMPER PLUG AND WIRE AN NORMALLY CLOSED CONTACT IN SERIES WITH THE CUT WIRE.
- IF OPTIONAL ECONOMIZER IS INSTALLED REMOVE ECON JUMPER AND PLUG IN NEW WIRELESS FROM ECONOMIZER KIT.
- IF PRIMARY (HIGH VOLTAGE) CONNECTIONS: TAP AT THE FACTORY AND BLACK WIRE TO COMMON TERMINAL FOR 208V SUPPLY POWER. (GRAY WIRE FROM 24VDC SUPPLY TO THE 208V TAP.)
- IF LINE VOLTAGE IS 480V OR 575V, INSTALL STEPPED DOWN TRANSFORMER AND CONNECT BLACK WIRE FROM VMC L1 TO RED WIRE ON TR2. PREZESTAT IS NOT INSTALLED.
- FUSE BLOCKS 1, 2, 3, 4, 5 ARE OPTIONAL.
- IF OPTIONAL SAFETY EQUIPMENT SUCH AS SMOKE DETECTOR IS INSTALLED, UNPLUG JUMPER PLUG AND WIRE IN SAFETY DEVICE. THE WIRE FROM THE SAFETY DEVICE TO THE PLUG IN THE ADDITIONAL DEVICES IN THE WIRING DIAGRAM. WIRE FROM THE LAST SAFETY DEVICE INSTALLED.

Wiring is subject to change. Always refer to the wiring diagram on the unit for the most up-to-date wiring.



WARNING

HIGH VOLTAGE!
DISCONNECT ALL POWER BEFORE SERVICING OR INSTALLING THIS UNIT.
MULTIPLE POWER SOURCES MAY BE PRESENT. FAILURE TO DO SO MAY
CAUSE PROPERTY DAMAGE, PERSONAL INJURY OR DEATH.

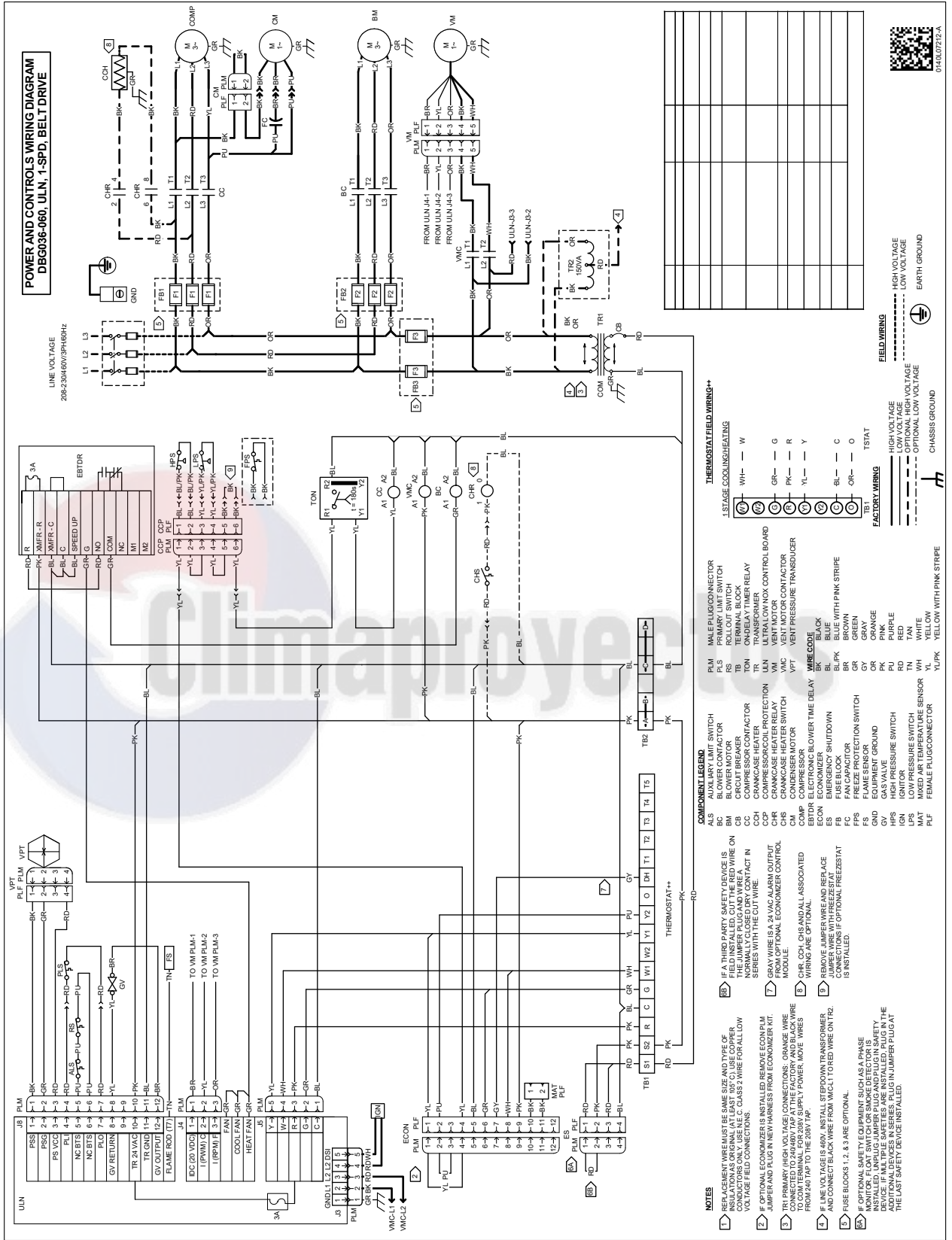

01400772-A

Wiring is subject to change. Always refer to the wiring diagram on the unit for the most up-to-date wiring.

WARNING

HIGH VOLTAGE!

DISCONNECT ALL POWER BEFORE SERVICING OR INSTALLING THIS UNIT.
MULTIPLE POWER SOURCES MAY BE PRESENT. FAILURE TO DO SO MAY
CAUSE PROPERTY DAMAGE, PERSONAL INJURY OR DEATH.

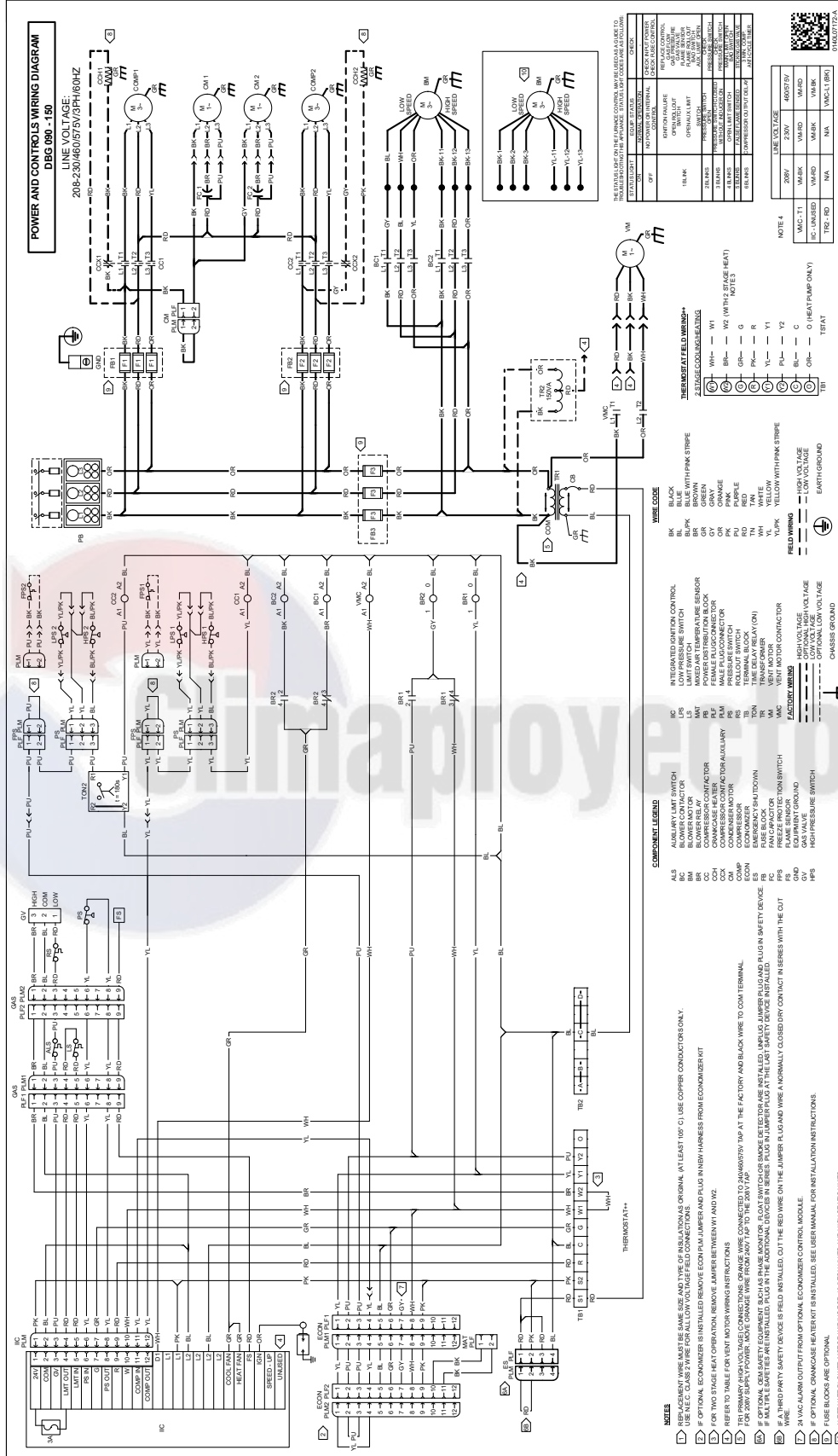

Wiring is subject to change. Always refer to the wiring diagram on the unit for the most up-to-date wiring.



WARNING

HIGH VOLTAGE!
DISCONNECT ALL POWER BEFORE SERVICING OR INSTALLING THIS UNIT.
MULTIPLE POWER SOURCES MAY BE PRESENT. FAILURE TO DO SO MAY
CAUSE PROPERTY DAMAGE, PERSONAL INJURY OR DEATH.

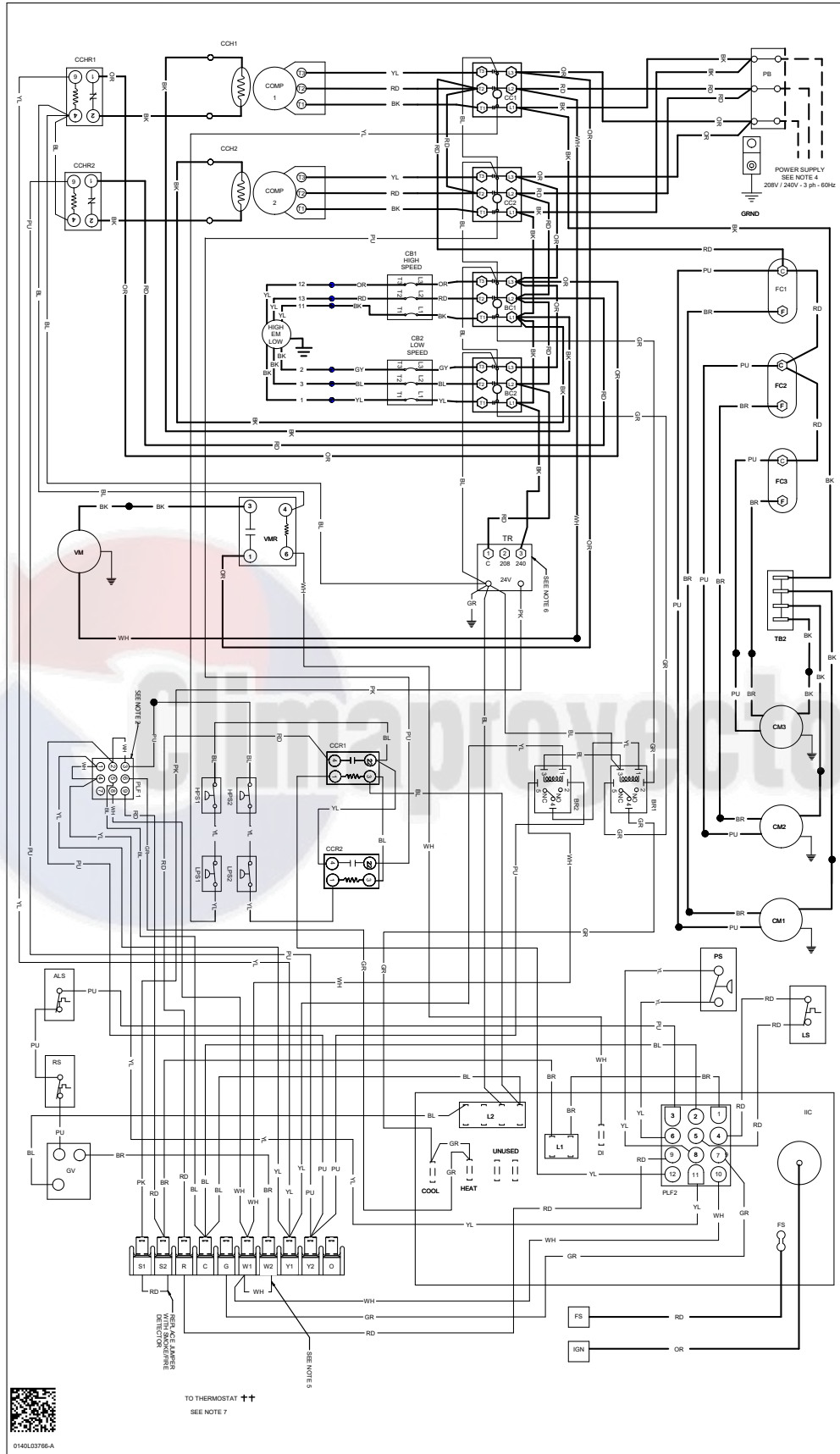

Wiring is subject to change. Always refer to the wiring diagram on the unit for the most up-to-date wiring.

HIGH VOLTAGE!
DISCONNECT ALL POWER BEFORE SERVICING OR INSTALLING THIS UNIT.
MULTIPLE POWER SOURCES MAY BE PRESENT. FAILURE TO DO SO MAY
CAUSE PROPERTY DAMAGE, PERSONAL INJURY OR DEATH.

WARNING

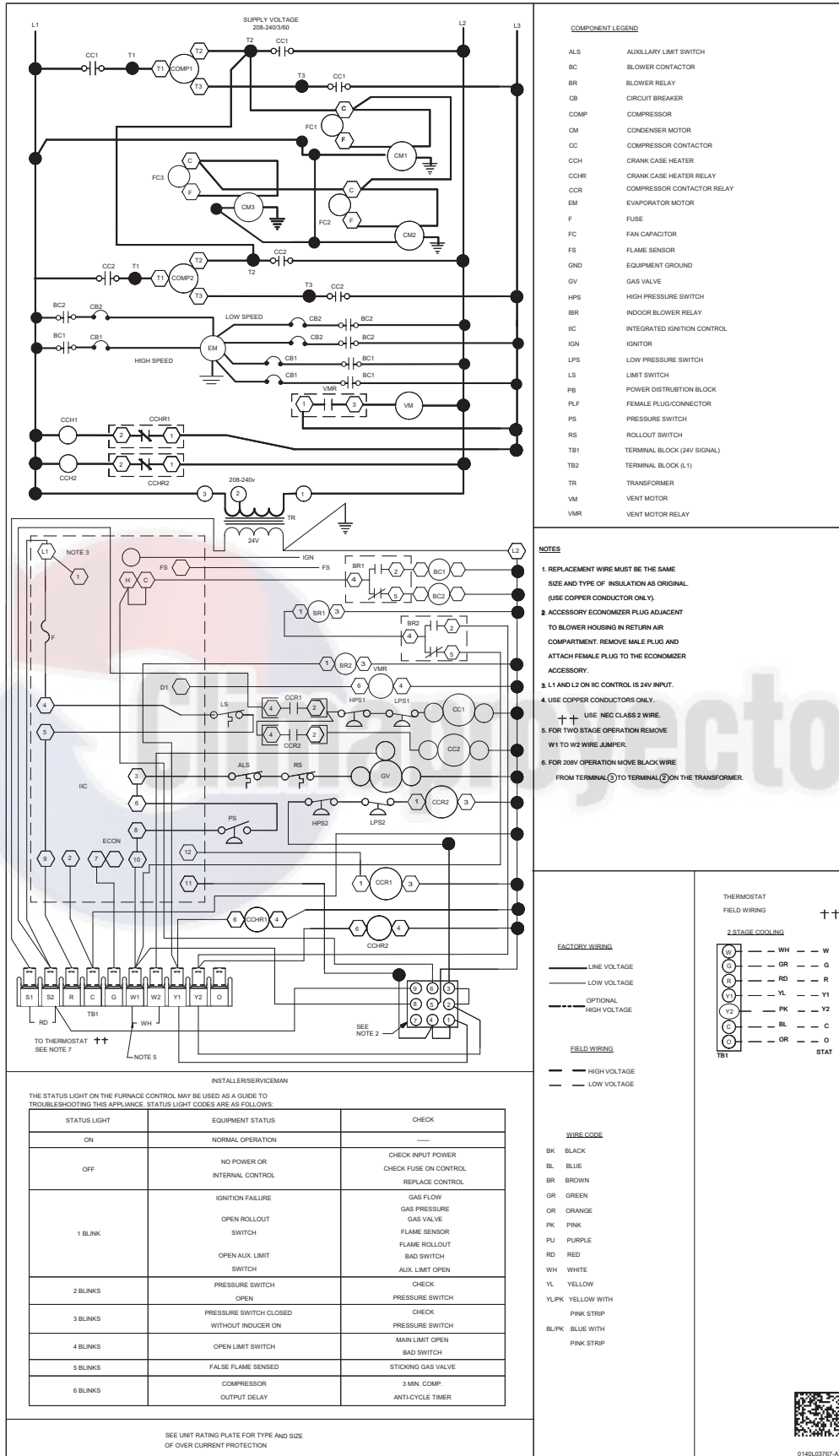

Wiring is subject to change. Always refer to the wiring diagram on the unit for the most up-to-date wiring.



WARNING

HIGH VOLTAGE!
 DISCONNECT ALL POWER BEFORE SERVICING OR INSTALLING THIS UNIT.
 MULTIPLE POWER SOURCES MAY BE PRESENT. FAILURE TO DO SO MAY
 CAUSE PROPERTY DAMAGE, PERSONAL INJURY OR DEATH.



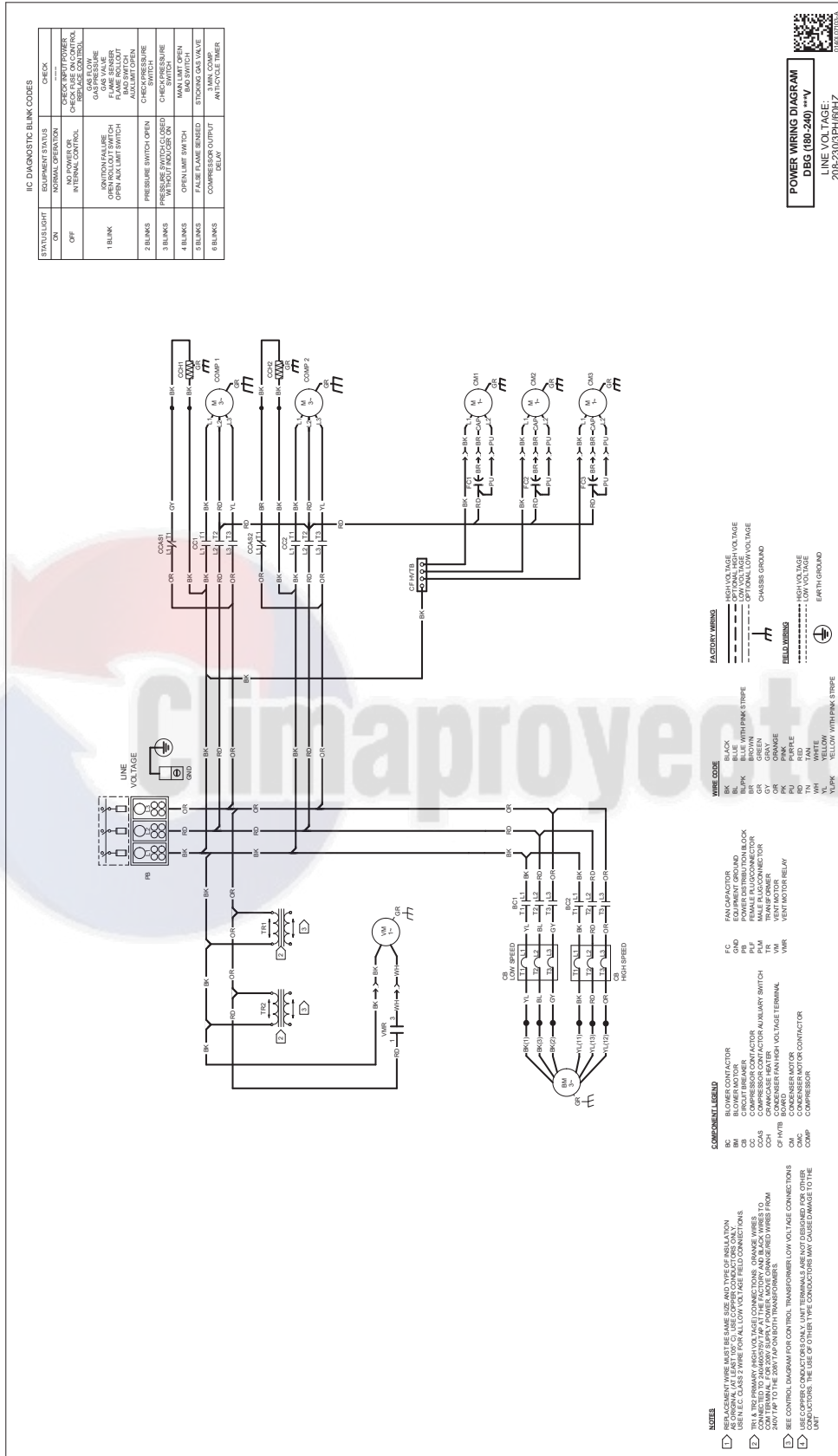



Wiring is subject to change. Always refer to the wiring diagram on the unit for the most up-to-date wiring.

WARNING

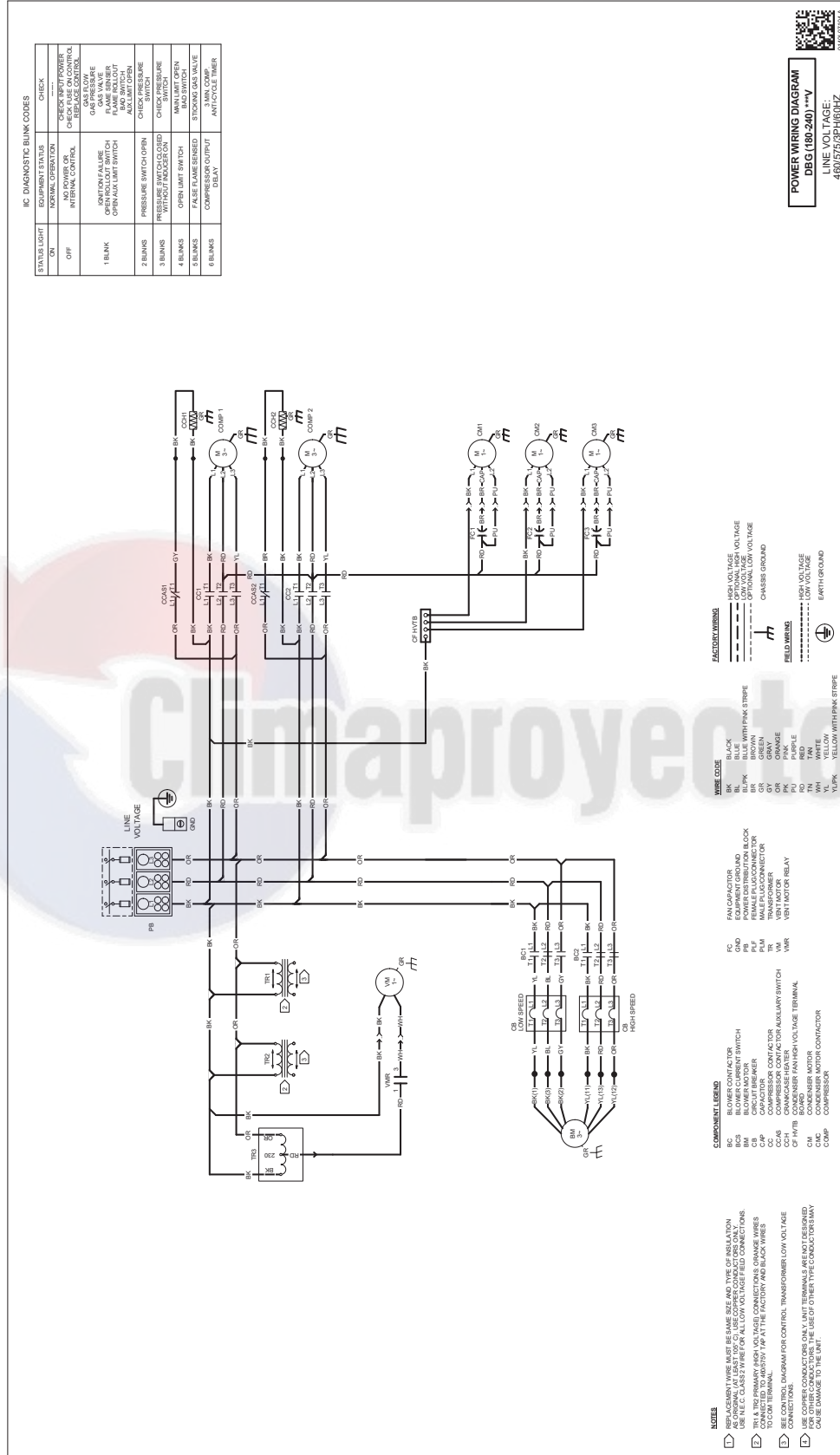
HIGH VOLTAGE!
DISCONNECT ALL POWER BEFORE SERVICING OR INSTALLING THIS UNIT.
MULTIPLE POWER SOURCES MAY BE PRESENT. FAILURE TO DO SO MAY
CAUSE PROPERTY DAMAGE, PERSONAL INJURY OR DEATH.



Wiring is subject to change. Always refer to the wiring diagram on the unit for the most up-to-date wiring.



WARNING

HIGH VOLTAGE!
 DISCONNECT ALL POWER BEFORE SERVICING OR INSTALLING THIS UNIT.
 MULTIPLE POWER SOURCES MAY BE PRESENT. FAILURE TO DO SO MAY
 CAUSE PROPERTY DAMAGE, PERSONAL INJURY OR DEATH.

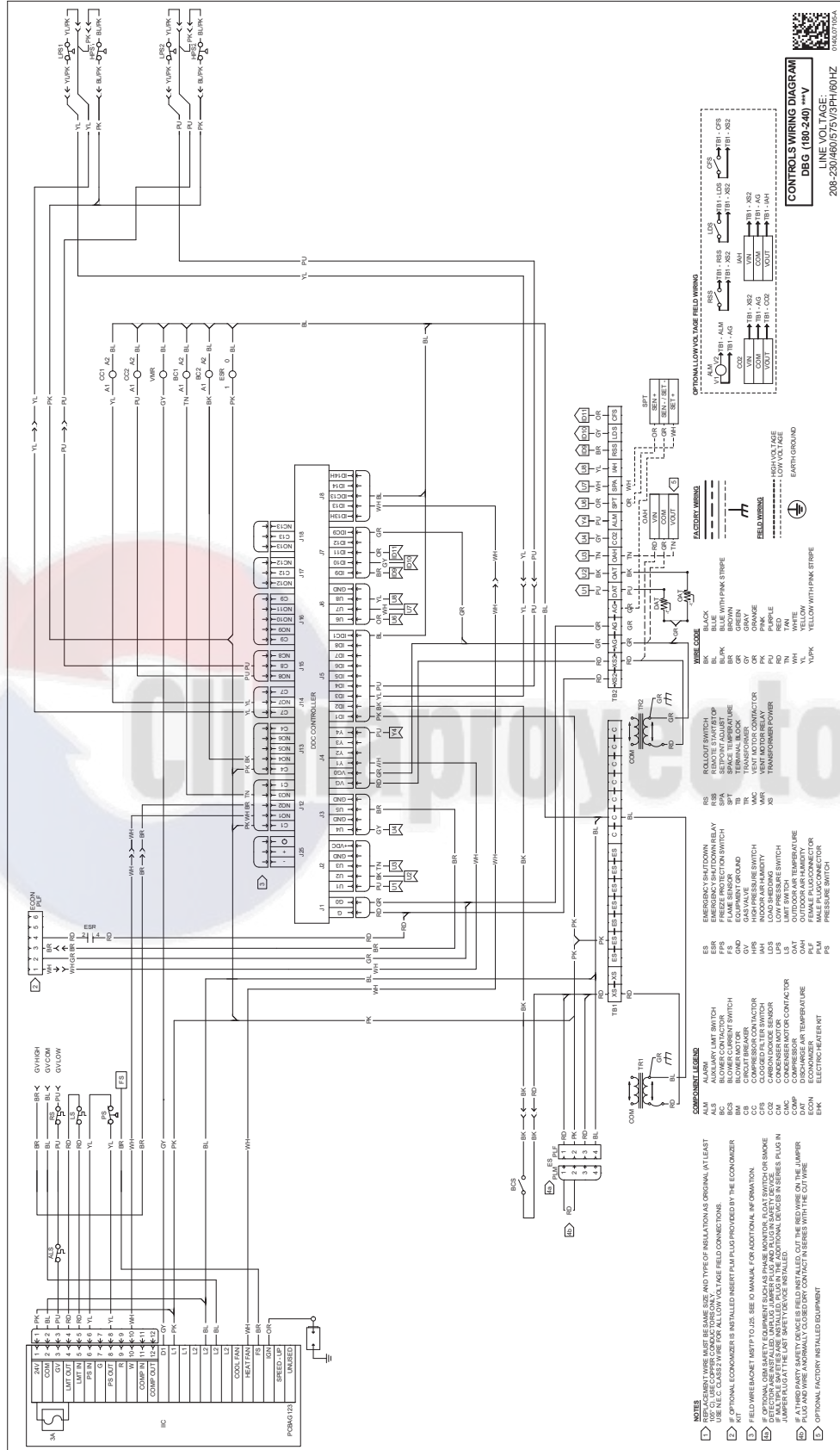



Wiring is subject to change. Always refer to the wiring diagram on the unit for the most up-to-date wiring.

UNIT WIRING DIAGRAMS

DBG300, 3PH 2 SPD, BELT

HIGH VOLTAGE!
DISCONNECT ALL POWER BEFORE SERVICING OR INSTALLING THIS UNIT.
MULTIPLE POWER SOURCES MAY BE PRESENT. FAILURE TO DO SO MAY
CAUSE PROPERTY DAMAGE, PERSONAL INJURY OR DEATH.

WARNING

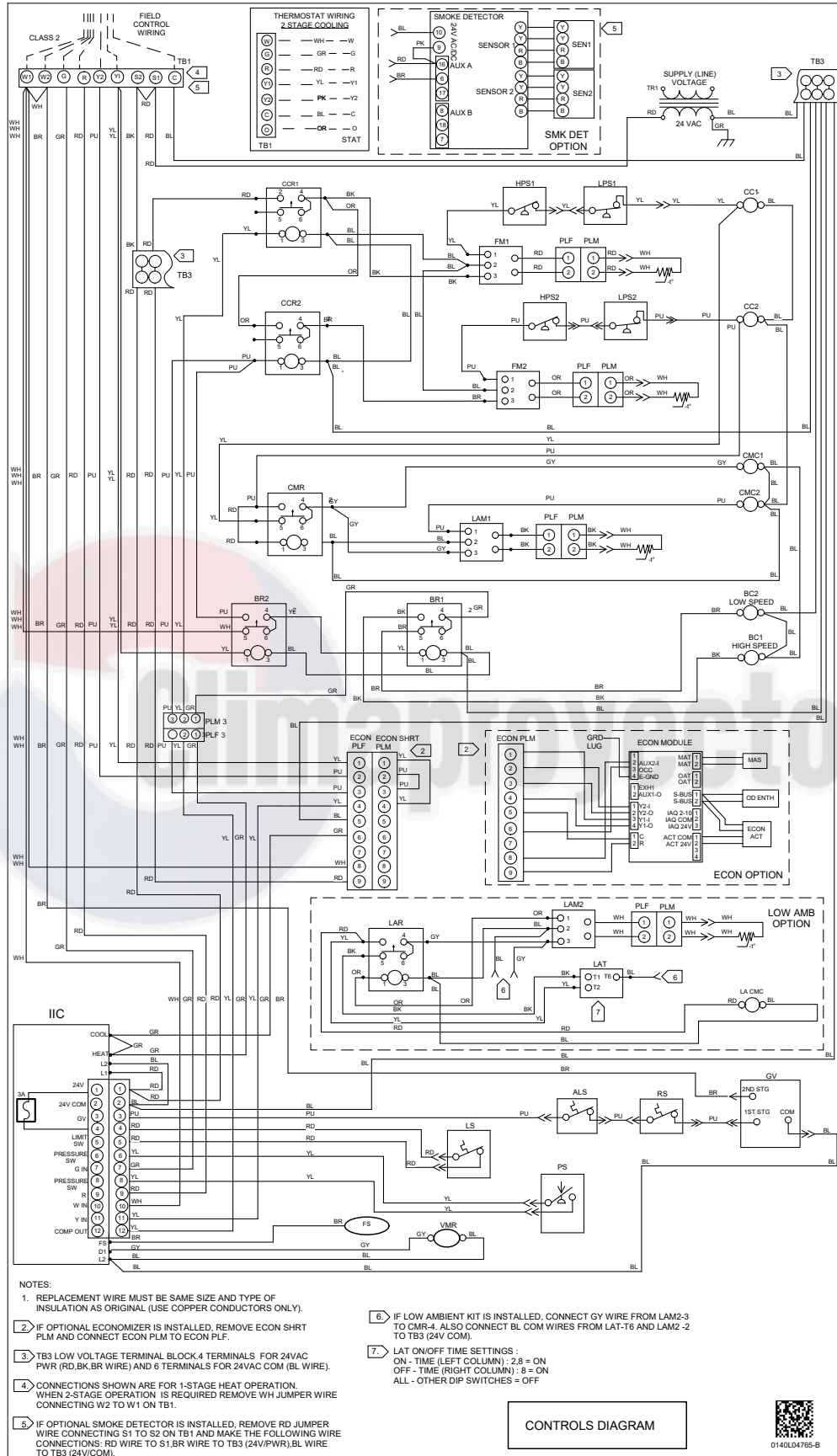
Wiring is subject to change. Always refer to the wiring diagram on the unit for the most up-to-date wiring.

UNIT WIRING DIAGRAMS

DBG300, 3PH 2 SPD, BELT

HIGH VOLTAGE!
 DISCONNECT ALL POWER BEFORE SERVICING OR INSTALLING THIS UNIT.
 MULTIPLE POWER SOURCES MAY BE PRESENT. FAILURE TO DO SO MAY
 CAUSE PROPERTY DAMAGE, PERSONAL INJURY OR DEATH.

WARNING

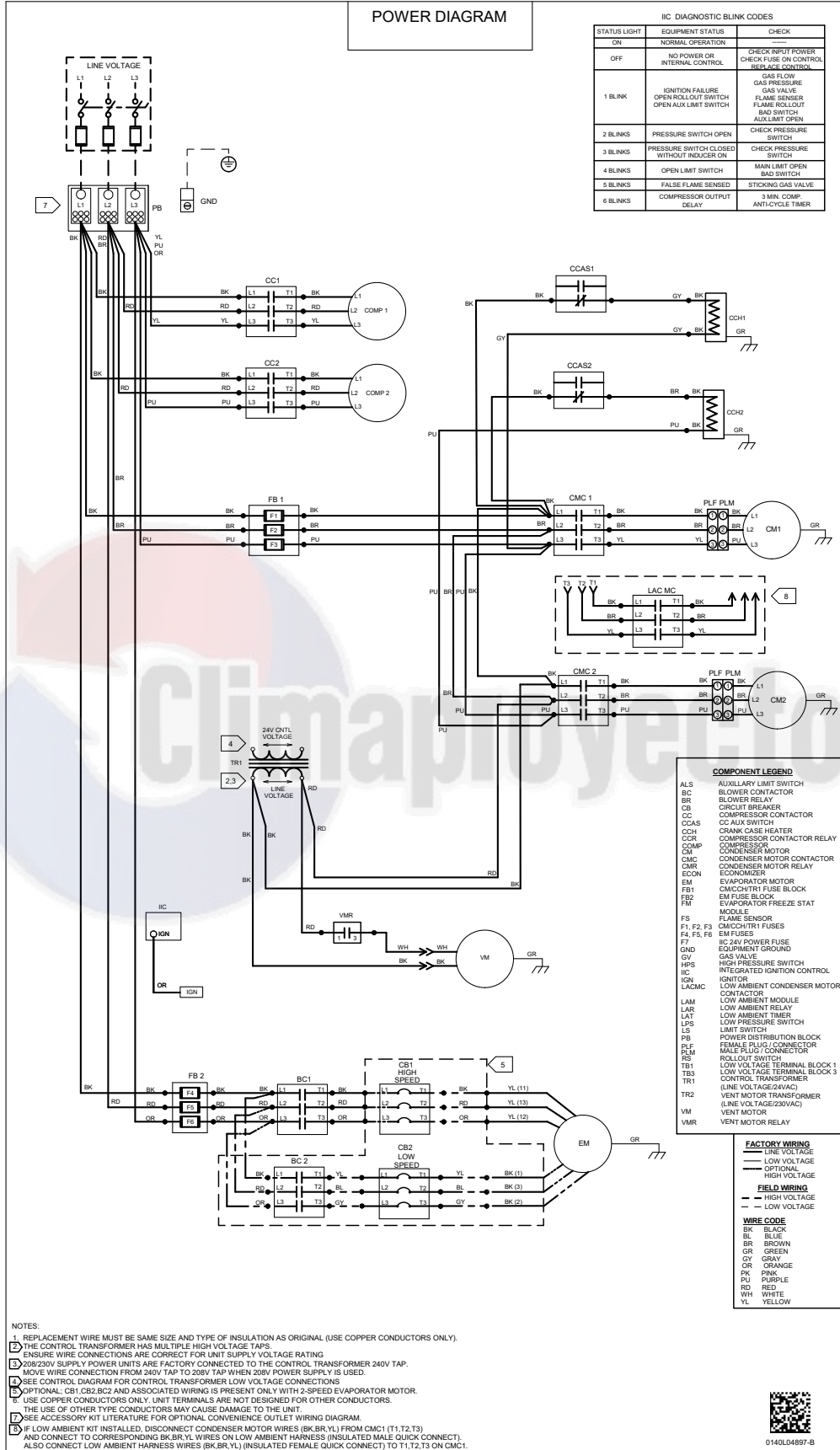

Wiring is subject to change. Always refer to the wiring diagram on the unit for the most up-to-date wiring.



WARNING

HIGH VOLTAGE!
 DISCONNECT ALL POWER BEFORE SERVICING OR INSTALLING THIS UNIT.
 MULTIPLE POWER SOURCES MAY BE PRESENT. FAILURE TO DO SO MAY
 CAUSE PROPERTY DAMAGE, PERSONAL INJURY OR DEATH.

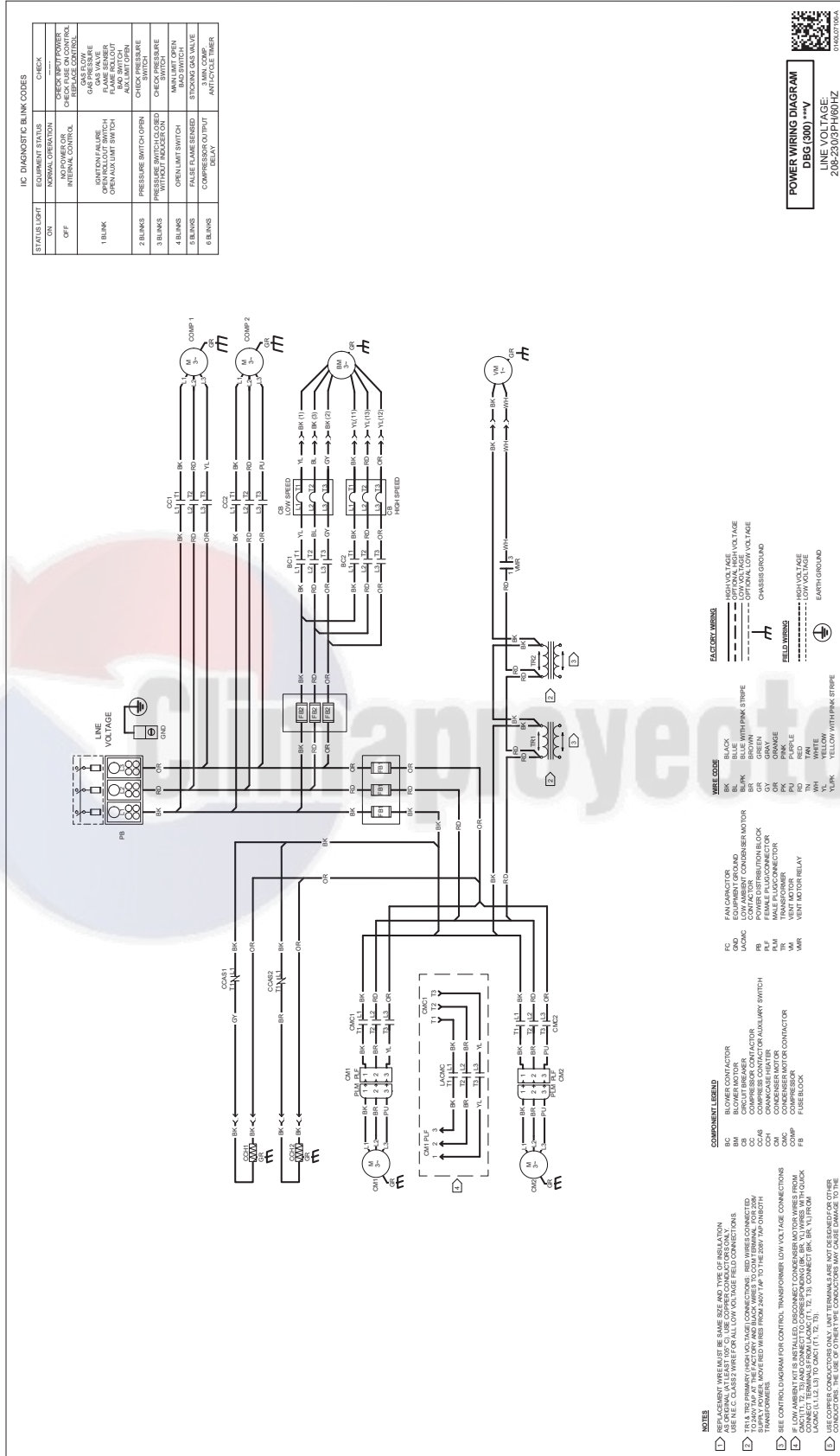

Wiring is subject to change. Always refer to the wiring diagram on the unit for the most up-to-date wiring.



WARNING

HIGH VOLTAGE!
 DISCONNECT ALL POWER BEFORE SERVICING OR INSTALLING THIS UNIT.
 MULTIPLE POWER SOURCES MAY BE PRESENT. FAILURE TO DO SO MAY
 CAUSE PROPERTY DAMAGE, PERSONAL INJURY OR DEATH.

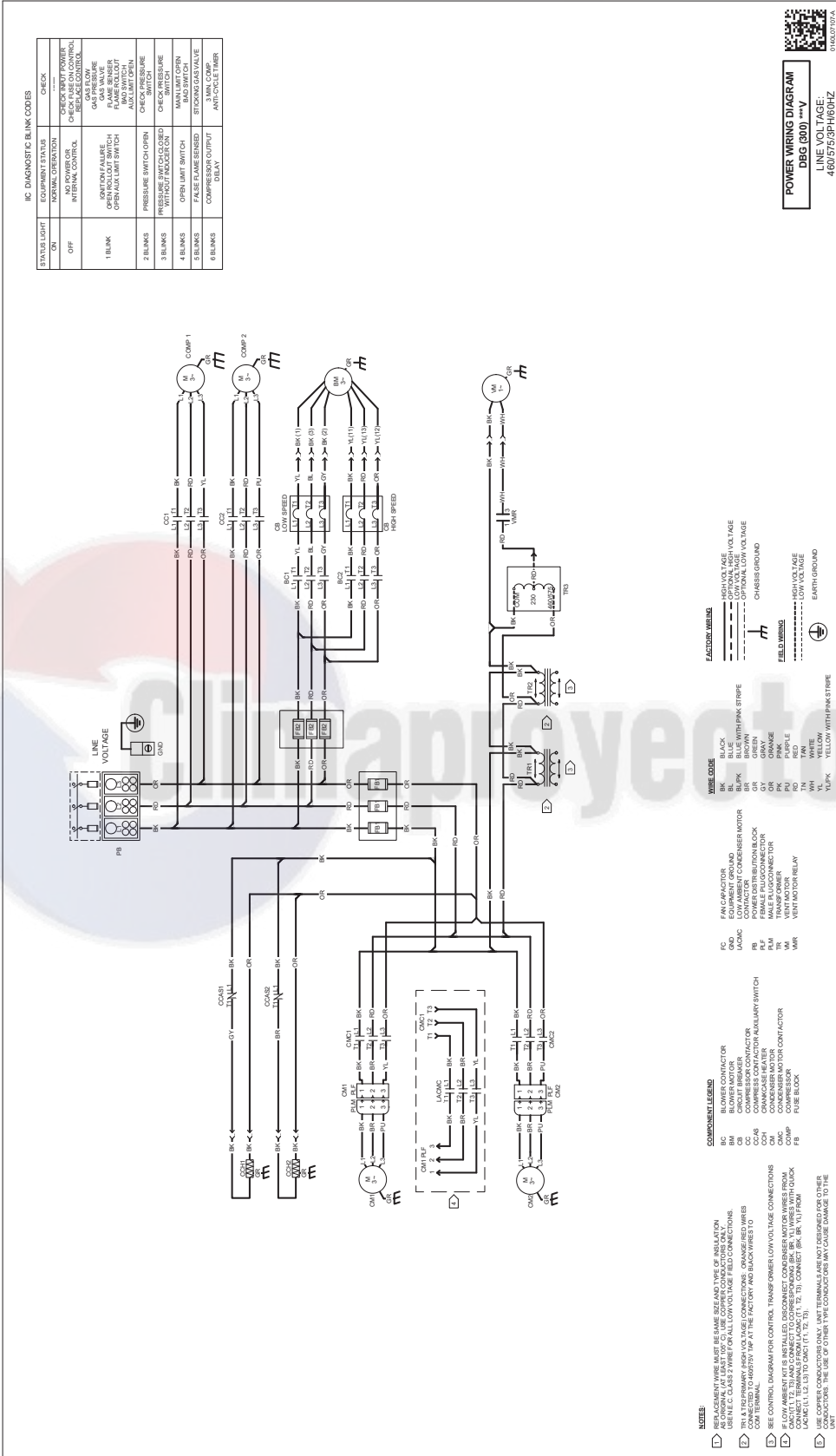

POWER WIRING DIAGRAM
 DBG (300) rev Y
 LINE VOLTAGE:
 480V/5/3PH/60HZ

Wiring is subject to change. Always refer to the wiring diagram on the unit for the most up-to-date wiring.

DFC WIRING DIAGRAMS



WARNING

HIGH VOLTAGE!
 DISCONNECT ALL POWER BEFORE SERVICING OR INSTALLING THIS UNIT.
 MULTIPLE POWER SOURCES MAY BE PRESENT. FAILURE TO DO SO MAY
 CAUSE PROPERTY DAMAGE, PERSONAL INJURY OR DEATH.

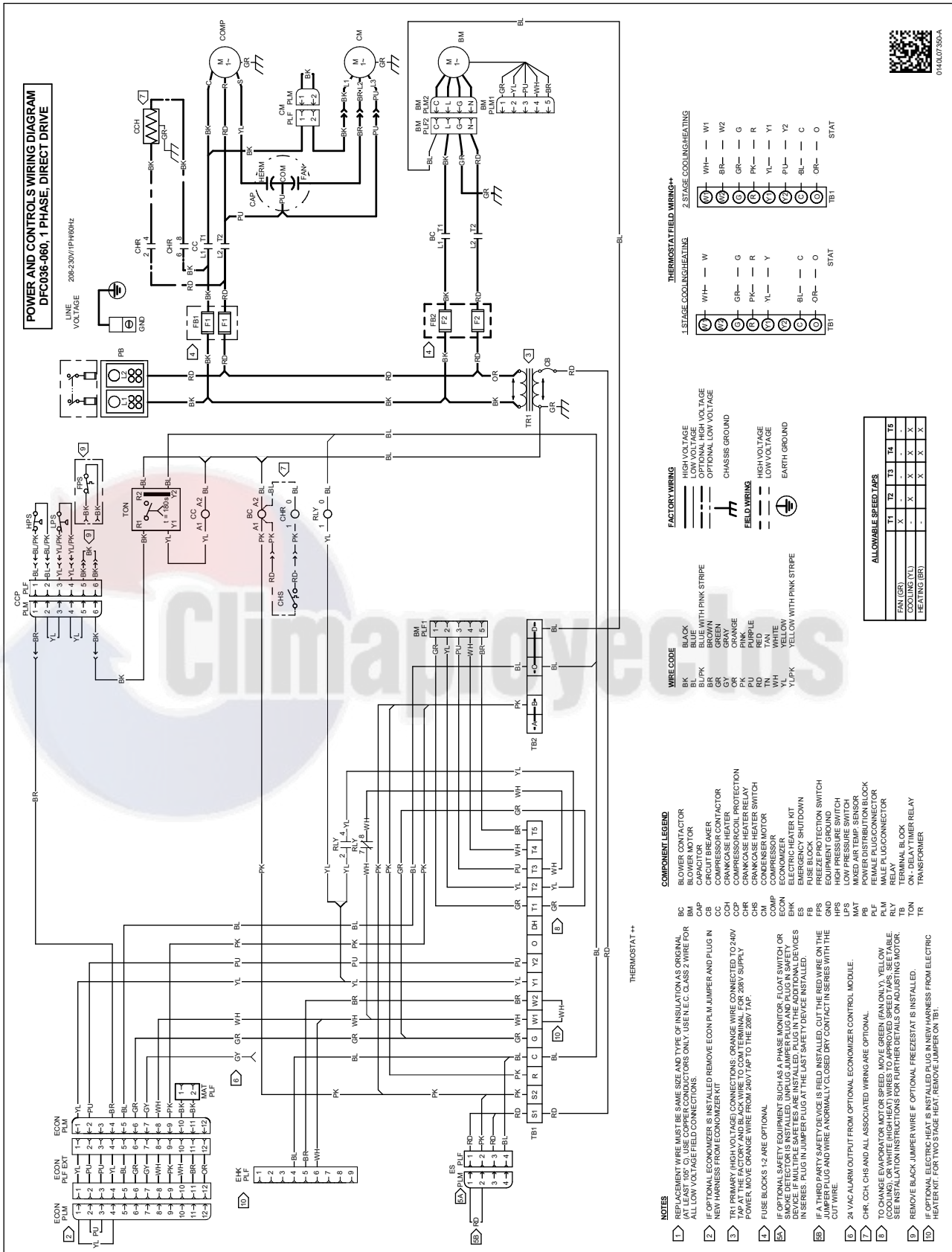

0146.07350A

Wiring is subject to change. Always refer to the wiring diagram on the unit for the most up-to-date wiring.



WARNING

HIGH VOLTAGE!
 DISCONNECT ALL POWER BEFORE SERVICING OR INSTALLING THIS UNIT.
 MULTIPLE POWER SOURCES MAY BE PRESENT. FAILURE TO DO SO MAY
 CAUSE PROPERTY DAMAGE, PERSONAL INJURY OR DEATH.

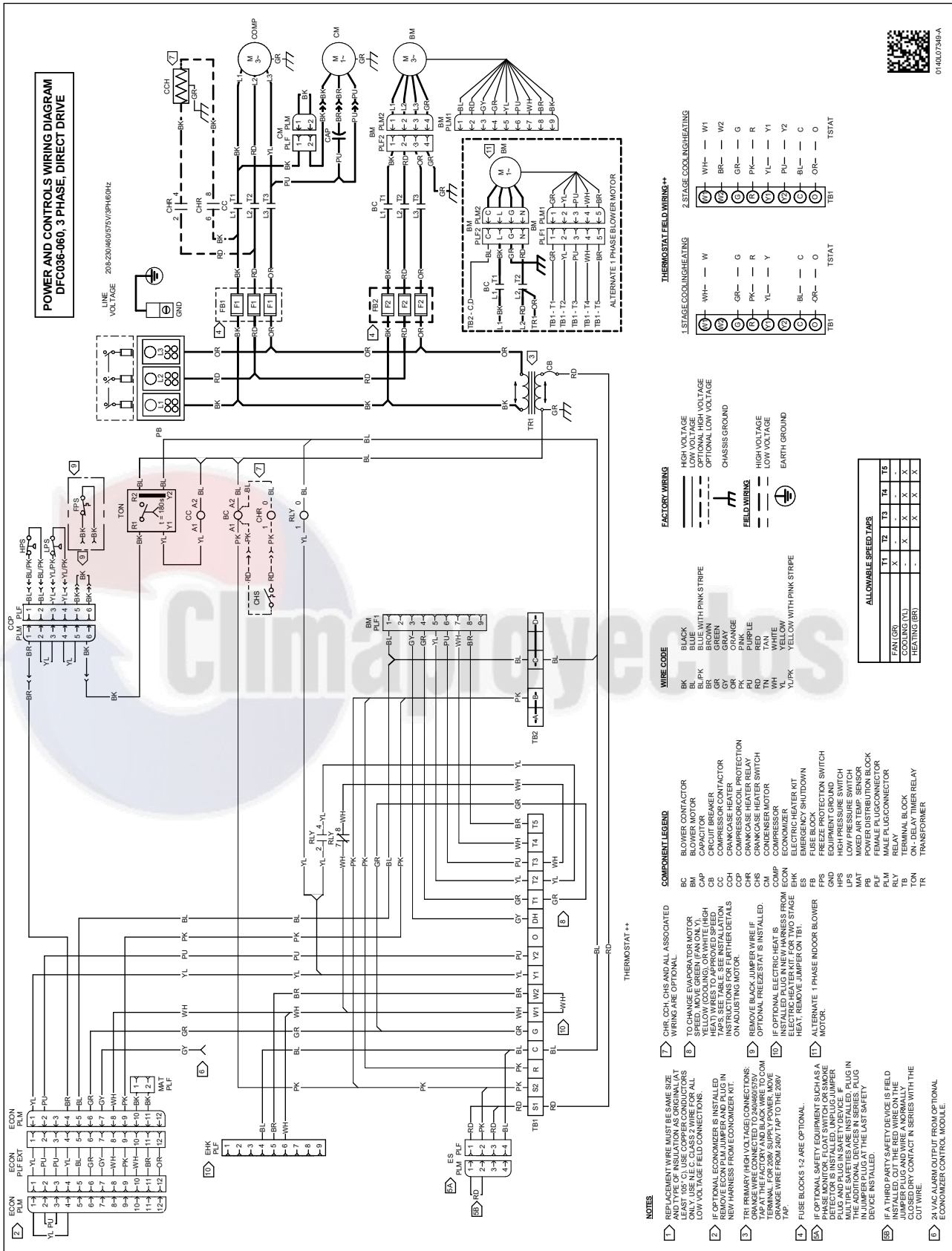

014607346-A

Wiring is subject to change. Always refer to the wiring diagram on the unit for the most up-to-date wiring.

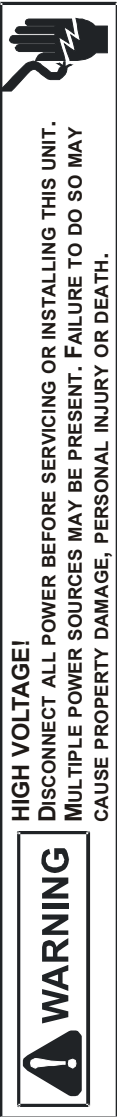

WARNING
HIGH VOLTAGE!
 DISCONNECT ALL POWER BEFORE SERVICING OR INSTALLING THIS UNIT.
 MULTIPLE POWER SOURCES MAY BE PRESENT. FAILURE TO DO SO MAY
 CAUSE PROPERTY DAMAGE, PERSONAL INJURY OR DEATH.

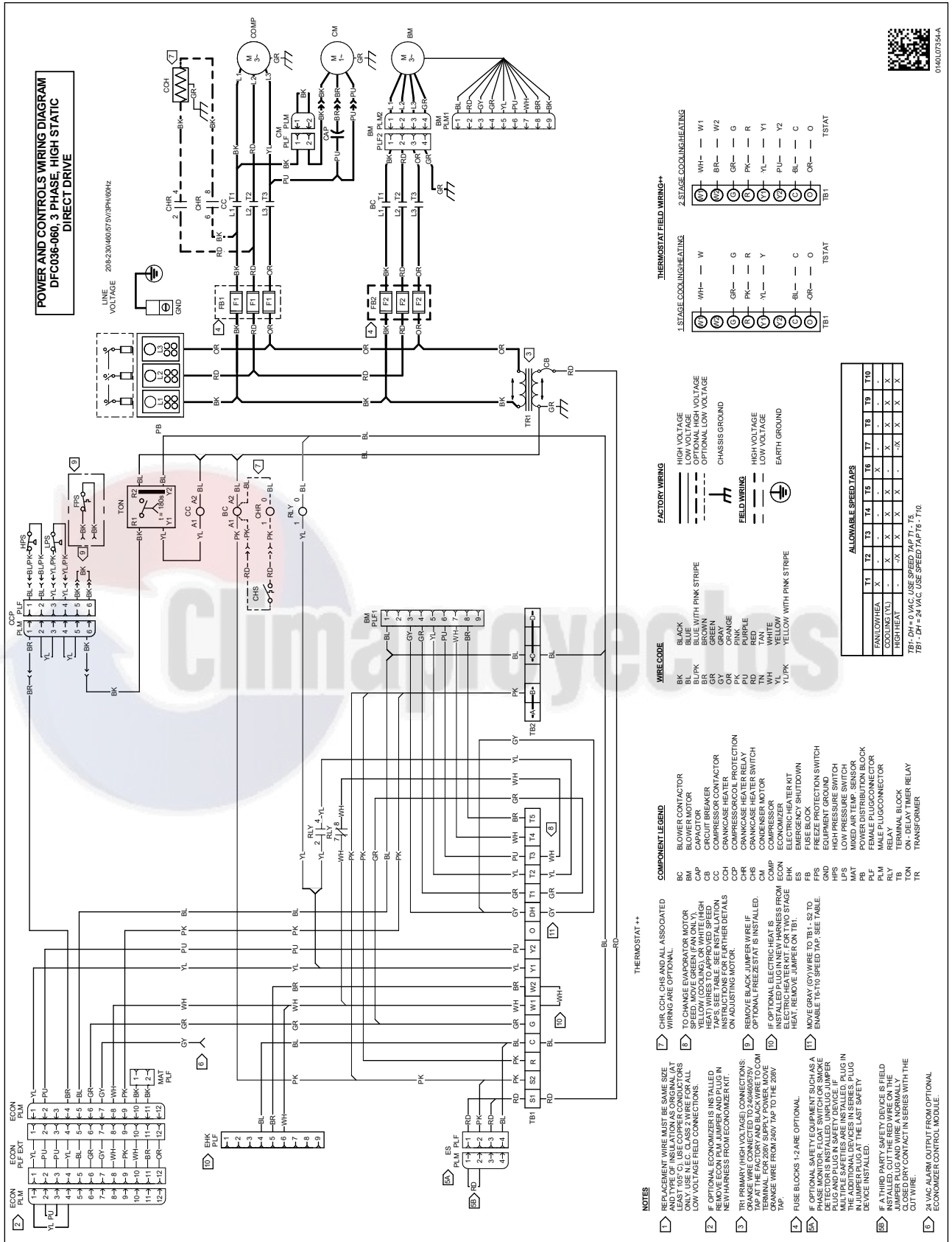

Wiring is subject to change. Always refer to the wiring diagram on the unit for the most up-to-date wiring.

DFG WIRING DIAGRAMS



WARNING

HIGH VOLTAGE!
 DISCONNECT ALL POWER BEFORE SERVICING OR INSTALLING THIS UNIT.
 MULTIPLE POWER SOURCES MAY BE PRESENT. FAILURE TO DO SO MAY
 CAUSE PROPERTY DAMAGE, PERSONAL INJURY OR DEATH.

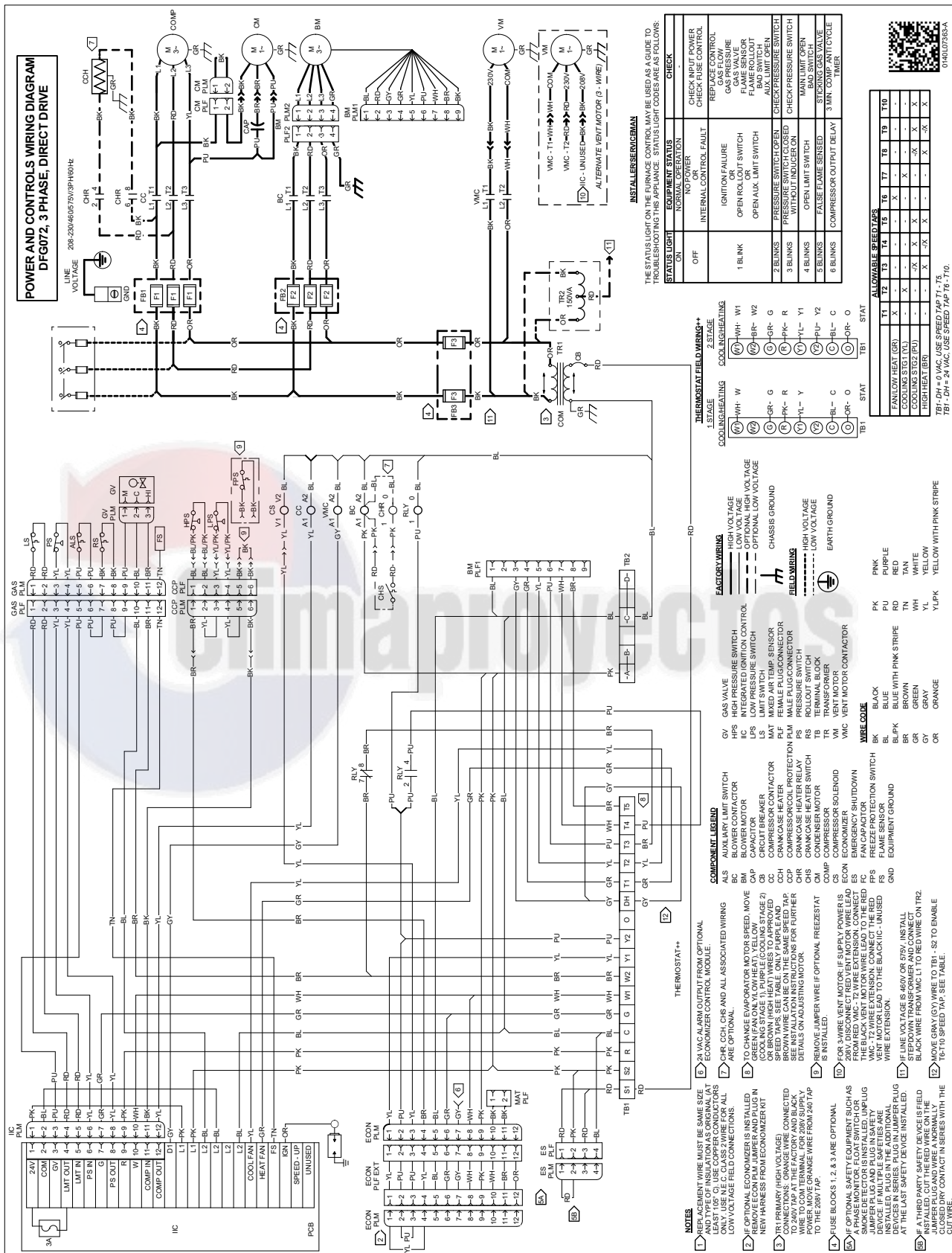

POWER AND CONTROLS WIRING DIAGRAM
 DFG072, 3 PHASE, DIRECT DRIVE

INSTALLER'S CHECKLIST

THE STATUS LIGHT ON THE BURNER CONTROL MAY BE USED AS A GUIDE TO TROUBLESHOOTING THE APPLIANCE. STATUS LIGHT CODES ARE AS FOLLOWS:

STATUS LIGHT	CODE	PROBLEM	CHECK
ON	NO POWER	INTERNAL CONTROL FAULT	REPLACE CIRCUIT BREAKER CHECK FUSE CONTROL
1 BLINK	IGNITION FAILURE	OPEN ROLUT OR OPEN AUK LIMIT SWITCH	GAS FLOW GAS VALVE FLAME SENSOR GAS VALVE BAD SWITCH AUK LIMIT OPEN
2 BLINKS	PRESSURE SENSORS	CHECK PRESSURE SWITCH WITHOUT INDUCER ON	CHECK PRESSURE SWITCH
3 BLINKS	OPEN LIMIT SWITCH	MARK LIMIT OPEN	MARK LIMIT OPEN
4 BLINKS	FALSE FLAME SWITCH	STICKING GAS VALVE	STICKING GAS VALVE
5 BLINKS	COMPRESSOR OUTPUT DELAY	3 MIN. COMP. ANTICYCLE	3 MIN. COMP. ANTICYCLE
6 BLINKS	TIMER		TIMER

THERMOSTAT FIELD WIRING

1 STAGE	2 STAGE	START
COOLING/HEATING	COOLING/HEATING	TB1
W	W	T1
W	W	T2
W	W	T3
W	W	T4
W	W	T5
W	W	T6
W	W	T7
W	W	T8
W	W	T9
W	W	T10

FACTORY WIRING

- SOLID LINE: HIGH VOLTAGE
- DASHED LINE: OPTIONAL HIGH VOLTAGE
- DOTTED LINE: CHASSIS GROUND

FIELD WIRING

- SOLID LINE: HIGH VOLTAGE
- DASHED LINE: LOW VOLTAGE
- DOTTED LINE: EARTH GROUND

COMPONENT LEGEND

- ALS: AUXILIARY LIMIT SWITCH
- BM: BLOWER MOTOR
- CC: CRANKCASE HEATER
- CC: COMPRESSOR CONTACTOR
- CC: CRANKCASE HEATER
- CC: COMPRESSOR COIL PROTECTION
- CC: FEMALE PLUG CONNECTOR
- CC: MALE PLUG CONNECTOR
- CC: ROLLOUT SWITCH
- CC: TRANSFORMER
- CC: VAC VENT MOTOR CONTACTOR

WIRE CODE

- PK: BLACK
- BL: BLUE
- BLPK: BLUE WITH PINK STRIPE
- GR: GREEN
- GY: GRAY
- OR: ORANGE
- PU: PURPLE
- RD: RED
- WH: WHITE
- YL: YELLOW
- YLPK: YELLOW WITH PINK STRIPE

- NOTES:**
- WIRING MUST BE THE SAME SIZE AND TYPE OF INSULATION AS ORIGINAL (AT ALL TIMES). ONLY USE A.C. CLASS WIRE FOR ALL WIRING.
 - OPTIONAL ECONOMIZER IS INSTALLED. REMOVE ECONOMIZER JUMPER AND PLUG IN NEW WIRE FROM ECONOMIZER KIT.
 - TRIP (HIGH VOLTAGE) CONNECTED TO 240V TAP AT THE FACTORY AND BLACK WIRE TO COMMON TERMINAL FOR 200V SUPPLY. REMOVE WIRE FROM 240 TAP TO THE 200V TAP.
 - FUSE BLOCKS 1, 2, & 3 ARE OPTIONAL.
 - FOR 3 WIRE VENT MOTOR: IF SUPPLY POWER IS 240V, REMOVE WIRE FROM VENT MOTOR AND FROM RED WIRE TAP. CONNECT TO BLACK WIRE FROM VMC-TZ WIRE EXTENSION. CONNECT TO BLACK WIRE FROM VMC-TZ WIRE EXTENSION. CONNECT TO BLACK WIRE FROM VMC-TZ WIRE EXTENSION. CONNECT TO BLACK WIRE FROM VMC-TZ WIRE EXTENSION.
 - IF LINE VOLTAGE IS 460V OR 575V, INSTALL STEP-DOWN TRANSFORMER AND CONNECT BLACK WIRE FROM VMC-L1 TO RED WIRE ON TR2.
 - IF LINE VOLTAGE IS 460V OR 575V, INSTALL STEP-DOWN TRANSFORMER AND CONNECT BLACK WIRE FROM VMC-L1 TO RED WIRE ON TR2.
 - IF LINE VOLTAGE IS 460V OR 575V, INSTALL STEP-DOWN TRANSFORMER AND CONNECT BLACK WIRE FROM VMC-L1 TO RED WIRE ON TR2.
 - IF LINE VOLTAGE IS 460V OR 575V, INSTALL STEP-DOWN TRANSFORMER AND CONNECT BLACK WIRE FROM VMC-L1 TO RED WIRE ON TR2.

Wiring is subject to change. Always refer to the wiring diagram on the unit for the most up-to-date wiring.

UNIT WIRING DIAGRAMS



WARNING

HIGH VOLTAGE!
DISCONNECT ALL POWER BEFORE SERVICING OR INSTALLING THIS UNIT.
MULTIPLE POWER SOURCES MAY BE PRESENT. FAILURE TO DO SO MAY
CAUSE PROPERTY DAMAGE, PERSONAL INJURY OR DEATH.

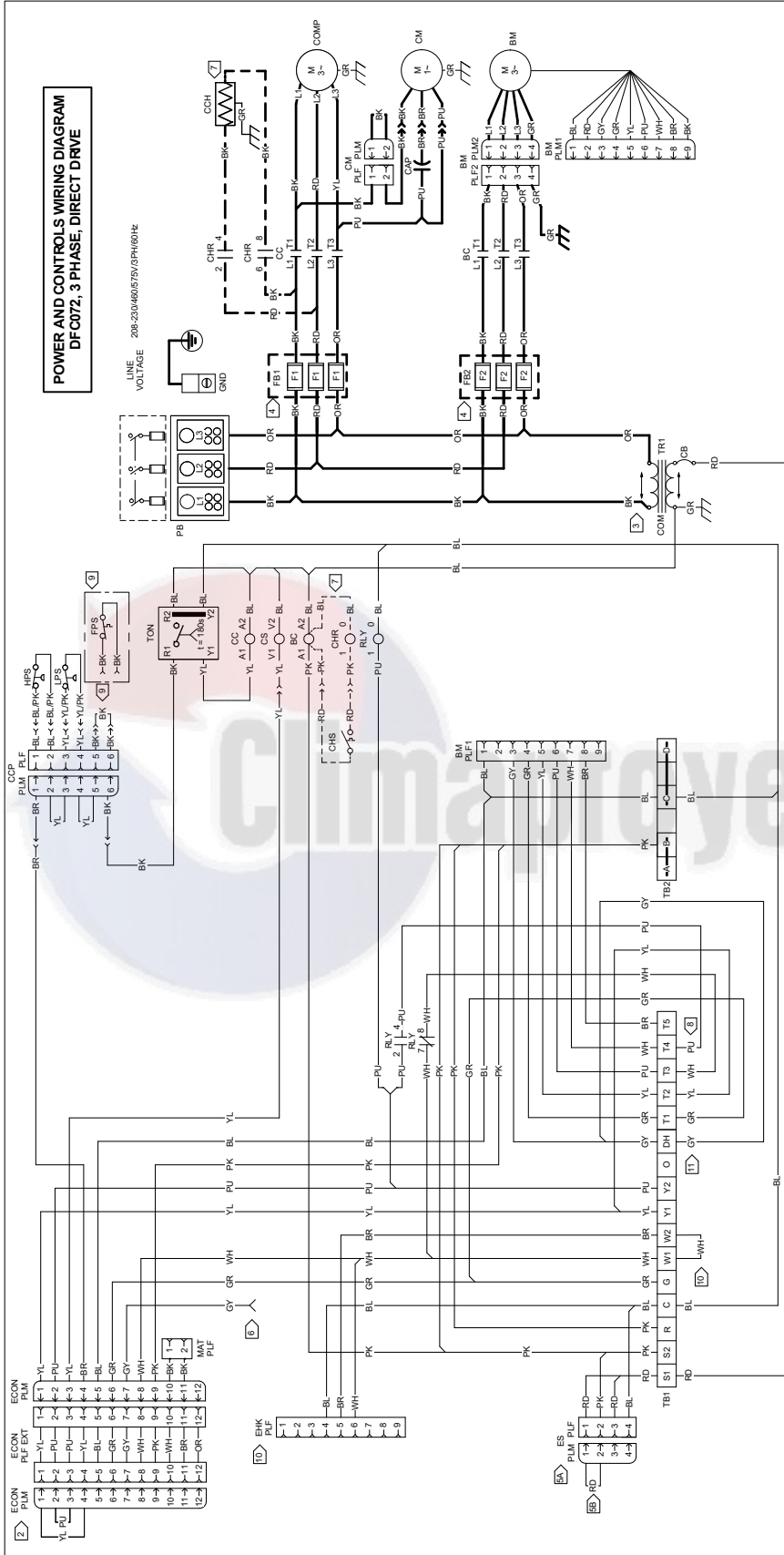

POWER AND CONTROLS WIRING DIAGRAM
DFC072, 3 PHASE, DIRECT DRIVE

LINE VOLTAGE 208-230V/400V/575V/3PH/60Hz

NOTES

- REPLACEMENT WIRE MUST BE SAME SIZE AND TYPE OF INSULATION AS ORIGINAL. AT ALL TIMES, USE N.E.C. CLASS 2 WIRE FOR ALL LOW VOLTAGE FIELD CONNECTIONS.
- IF OPTIONAL ECONOMIZER IS INSTALLED, REMOVE ECON PLM JUMPER AND PLUS IN NEW HARNESS FROM ECONOMIZER KIT.
- TR1 PRIMARY HIGH VOLTAGE CONNECTIONS: TERMINAL FOR 208V SUPPLY POWER, MOVE JUMPER WIRE FROM ADV TAP TO THE 208V TAP AT THE FACTORY AND BLACK WIRE TO COMP MOTOR.
- OPTIONAL FREEZE STAT IS INSTALLED.
- IF OPTIONAL ELECTRIC HEAT IS INSTALLED PLUG IN NEW HARNESS FROM ELECTRIC HEATER KIT FOR TWO STAGE HEAT. REMOVE JUMPER ON TB1.
- REMOVE GRAY (G) WIRE TO TB1. ENABLE 16-10 BAYES TAP. SEE TABLE.
- FUSE BLOCKS 1, 2 ARE OPTIONAL.
- IF OPTIONAL SAFETY EQUIPMENT SUCH AS A DETECTOR IS INSTALLED, UNPLUG JUMPER PLUG AND PLUS IN NEW HARNESS FROM THE ADDITIONAL DEVICES N SERIES. PLUG IN JUMPER PLUG AT THE LAST SAFETY DEVICE INSTALLED.
- IF A THIRD PARTY SAFETY DEVICE IS FIELD WIRING, UNPLUG JUMPER PLUG AND NORMALLY CLOSED DRY CONTACT IN SERIES WITH THE CUT WIRE.
- 24 VAC ALARM OUTPUT FROM OPTIONAL ECONOMIZER CONTROL MODULE.

COMPONENT LEGEND

- BC BLOWER CONTACTOR
- BM BLOWER MOTOR
- CAP CAPACITOR
- CB CIRCUIT BREAKER
- CHR COMPRESSOR HEATER
- CHS CRANK CASE HEATER
- COM COMPRESSOR MOTOR
- CS COMPRESSOR SOLENOID
- ECON ECONOMIZER
- EHK ELECTRIC HEATER KIT
- EMR ELECTRIC MOTOR SHUTDOWN
- FB FUSE BLOCK
- FFS FREEZE PROTECTION SWITCH
- GND EQUIPMENT GROUND
- HPS HIGH PRESSURE SWITCH
- MAT MIXED AIR TEMP. SENSOR
- PF POWER DISTRIBUTION BLOCK
- PLF FEMALE PLUG CONNECTOR
- PLM MALE PLUG CONNECTOR
- REL RELAY
- TB TERMINAL BLOCK
- TON ON-DELAY TIMER RELAY
- TR TRANSFORMER

WIRE CODE

- BK BLACK
- BL BLUE
- BL/PK BLUE WITH PINK STRIPE
- BR BROWN
- GR GRAY
- GY GREEN
- OR ORANGE
- PK PURPLE
- RD RED
- RY YELLOW
- WH WHITE
- YL/YL/PK YELLOW WITH PINK STRIPE

FACTORY WIRING

- SOLID LINE HIGH VOLTAGE
- DASHED LINE LOW VOLTAGE
- DOTTED LINE OPTIONAL HIGH VOLTAGE
- THICK LINE CHASSIS GROUND
- THIN LINE FIELD WIRING
- THIN LINE WITH PINK STRIPE HIGH VOLTAGE
- THIN LINE WITH PINK STRIPE LOW VOLTAGE
- THIN LINE WITH PINK STRIPE EARTH GROUND

THERMOSTAT FIELD WIRINGS**

1 STAGE COOLING/HEATING		2 STAGE COOLING/HEATING	
WH	W	WH	W
W1	W2	W1	W2
GR	G	GR	G
PK	R	PK	R
YL	Y	YL	Y
PU	Y2	PU	Y2
BL	C	BL	C
OR	O	OR	O
TB1	TSTAT	TB1	TSTAT

ALLOWABLE SPEEDS

	T1	T2	T3	T4	T5	T6	T7	T8	T9	T10
FAN ONLY (CS)	X	X	X	X	X	X	X	X	X	X
COOLING STAGE (YL)	X	X	X	X	X	X	X	X	X	X
COOLING STAGE (PU)	X	X	X	X	X	X	X	X	X	X
HEATING (WH)	X	X	X	X	X	X	X	X	X	X

TB1-DH = 0 VAC. USE SPEED TAP T1 - T5.
TB1-DH = 24 VAC. USE SPEED TAP T6 - T10.

041007985A

Wiring is subject to change. Always refer to the wiring diagram on the unit for the most up-to-date wiring.

135

UNIT WIRING DIAGRAMS

WARNING

HIGH VOLTAGE!
 DISCONNECT ALL POWER BEFORE SERVICING OR INSTALLING THIS UNIT.
 MULTIPLE POWER SOURCES MAY BE PRESENT. FAILURE TO DO SO MAY
 CAUSE PROPERTY DAMAGE, PERSONAL INJURY OR DEATH.

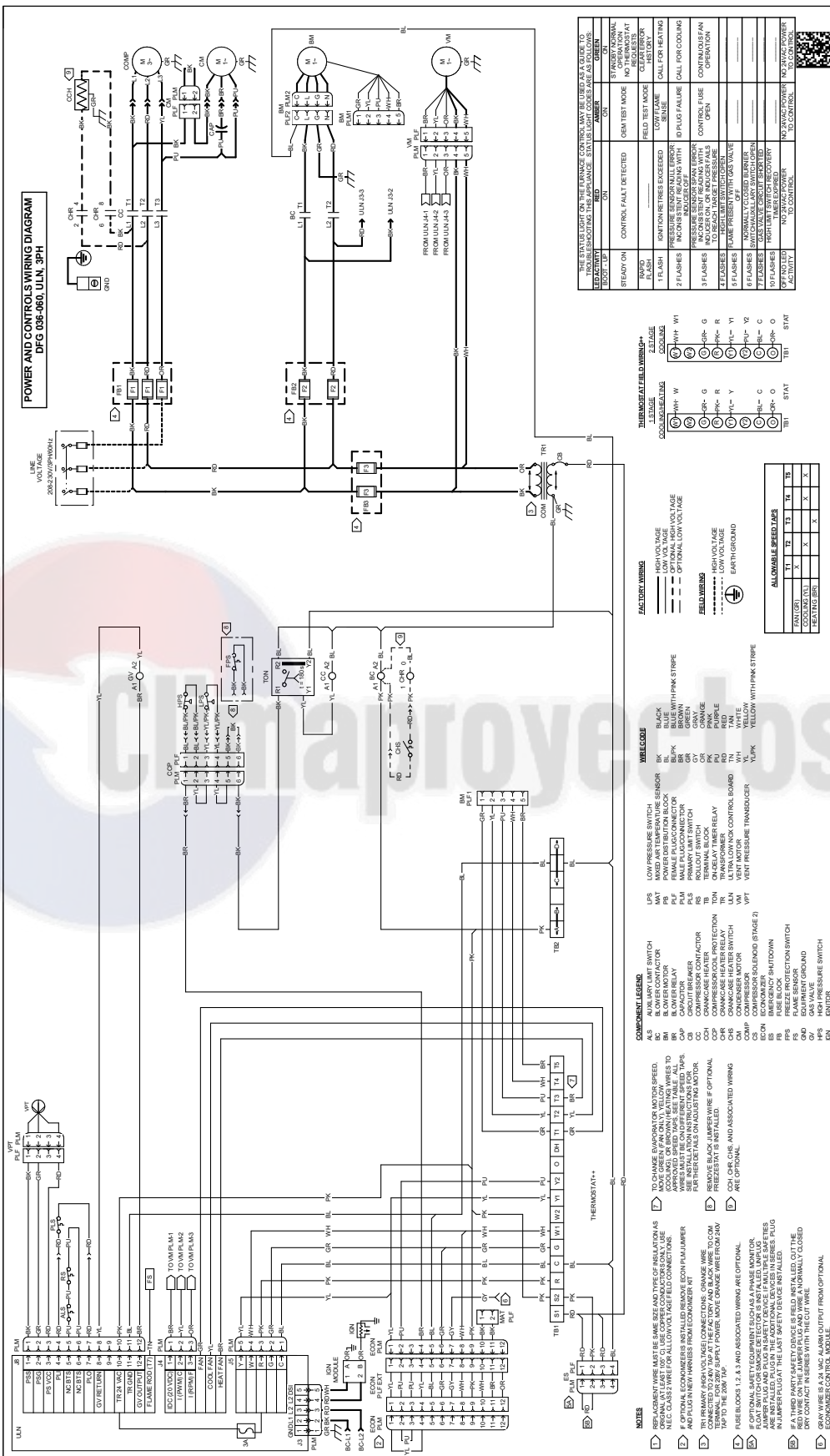

Wiring is subject to change. Always refer to the wiring diagram on the unit for the most up-to-date wiring.

UNIT WIRING DIAGRAMS



WARNING

HIGH VOLTAGE!
 DISCONNECT ALL POWER BEFORE SERVICING OR INSTALLING THIS UNIT.
 MULTIPLE POWER SOURCES MAY BE PRESENT. FAILURE TO DO SO MAY
 CAUSE PROPERTY DAMAGE, PERSONAL INJURY OR DEATH.

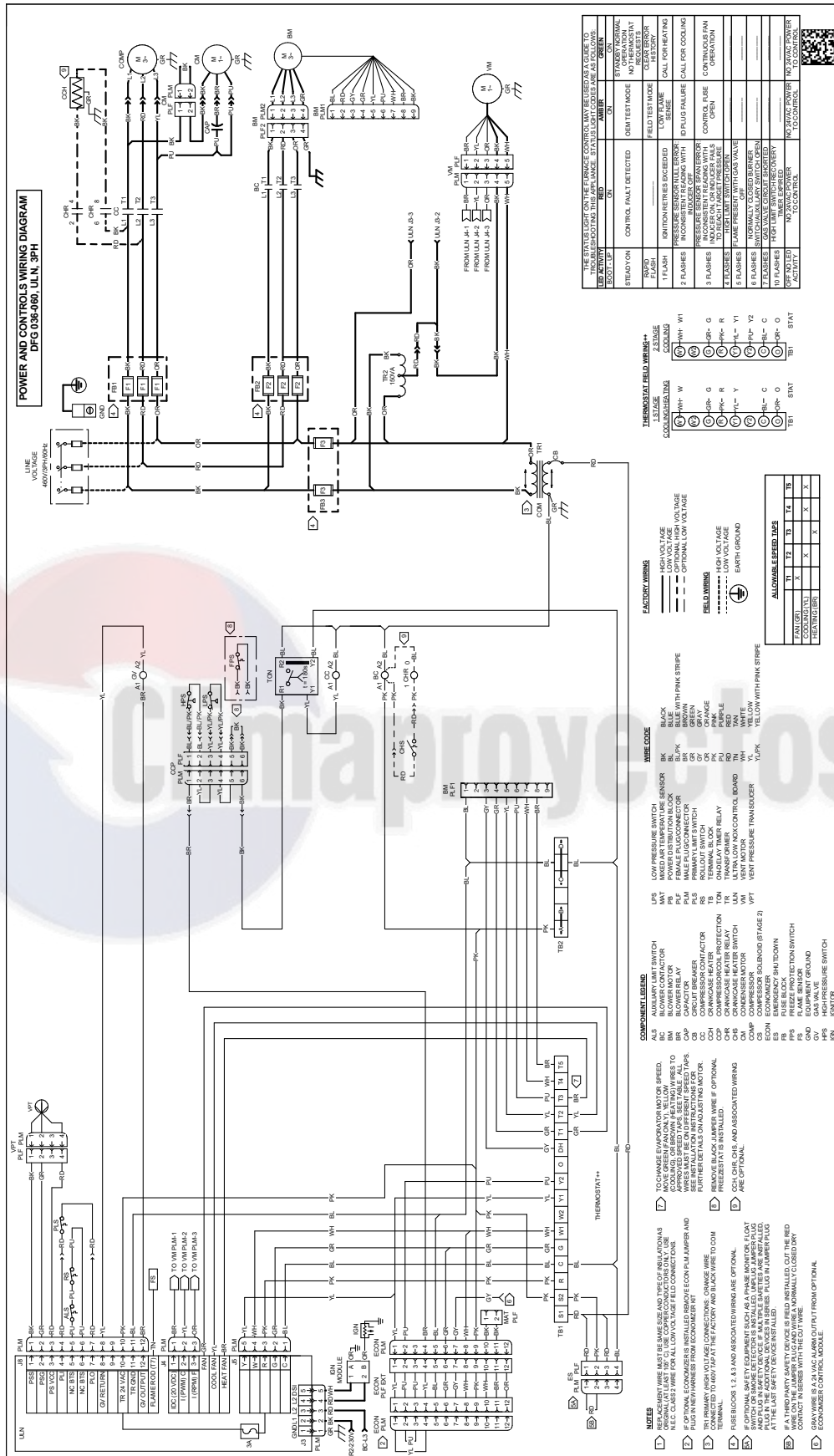

THE STATUS OF THE UNIT FOR THE INDICATED NUMBER OF FLAMES IS AS FOLLOWS:
 0 - NO FLAMES
 1 - 1 FLAME
 2 - 2 FLAMES
 3 - 3 FLAMES
 4 - 4 FLAMES
 5 - 5 FLAMES
 6 - 6 FLAMES
 7 - 7 FLAMES
 8 - 8 FLAMES
 9 - 9 FLAMES
 10 - 10 FLAMES

STATUS	CONTROL FAULT DETECTED	HEAT TEST MODE	FIELD TEST MODE	STATUS NORMAL
0	NO	NO	NO	NO
1	NO	NO	NO	NO
2	NO	NO	NO	NO
3	NO	NO	NO	NO
4	NO	NO	NO	NO
5	NO	NO	NO	NO
6	NO	NO	NO	NO
7	NO	NO	NO	NO
8	NO	NO	NO	NO
9	NO	NO	NO	NO
10	NO	NO	NO	NO

THERMOSTAT FIELD WIRING

LEAD	WIRING
1	W1 - W
2	R - R
3	G - G
4	Y - Y
5	W1 - W1
6	R - R
7	G - G
8	Y - Y
9	W1 - W1
10	R - R
11	G - G
12	Y - Y
13	W1 - W1
14	R - R
15	G - G
16	Y - Y
17	W1 - W1
18	R - R
19	G - G
20	Y - Y
21	W1 - W1
22	R - R
23	G - G
24	Y - Y
25	W1 - W1
26	R - R
27	G - G
28	Y - Y
29	W1 - W1
30	R - R
31	G - G
32	Y - Y
33	W1 - W1
34	R - R
35	G - G
36	Y - Y
37	W1 - W1
38	R - R
39	G - G
40	Y - Y
41	W1 - W1
42	R - R
43	G - G
44	Y - Y
45	W1 - W1
46	R - R
47	G - G
48	Y - Y
49	W1 - W1
50	R - R
51	G - G
52	Y - Y
53	W1 - W1
54	R - R
55	G - G
56	Y - Y
57	W1 - W1
58	R - R
59	G - G
60	Y - Y
61	W1 - W1
62	R - R
63	G - G
64	Y - Y
65	W1 - W1
66	R - R
67	G - G
68	Y - Y
69	W1 - W1
70	R - R
71	G - G
72	Y - Y
73	W1 - W1
74	R - R
75	G - G
76	Y - Y
77	W1 - W1
78	R - R
79	G - G
80	Y - Y
81	W1 - W1
82	R - R
83	G - G
84	Y - Y
85	W1 - W1
86	R - R
87	G - G
88	Y - Y
89	W1 - W1
90	R - R
91	G - G
92	Y - Y
93	W1 - W1
94	R - R
95	G - G
96	Y - Y
97	W1 - W1
98	R - R
99	G - G
100	Y - Y

FACTORY WIRING

- SOLID LINE: HIGH VOLTAGE
- DASHED LINE: LOW VOLTAGE
- DOTTED LINE: OPTIONAL LOW VOLTAGE

FIELD WIRING

- SOLID LINE: HIGH VOLTAGE
- DASHED LINE: LOW VOLTAGE
- DOTTED LINE: EARTH GROUND

ALLOWABLE WIRING TYPES

WIRING TYPE	1	2	3	4	5
HEATING (H)	X	X	X	X	X
COOLING (C)	X	X	X	X	X
HEATING/COOLING (HC)	X	X	X	X	X
VENT (V)	X	X	X	X	X
VENT WITH PINK STRIPE (VPS)	X	X	X	X	X

WIRE CODE

- BLACK
- BLUE
- BROWN
- GRAY
- GREEN
- PINK
- RED
- WHITE
- YELLOW
- YELLOW WITH PINK STRIPE

COMPONENT LEGENDS

- 1S: LOW PRESSURE SWITCH
- 1M: MIMED AIR TEMPERATURE SENSOR
- 1P: POWER DISTRIBUTION BLOCK
- 1R: MAIN PULG CONNECTOR
- 1S: ROLLOUT SWITCH
- 1T: TERMINAL BLOCK
- 1TR: TRANSFORMER
- 1V: VENT MOTOR
- 1VPT: VENT PRESSURE TRANSDUCER
- 1W: WIRE
- 1X: ECONOMIZER (BOILER/STAGE 2)
- 1Y: EMERGENCY SHUTDOWN
- 1Z: FREEZE PROTECTION SWITCH
- 1AA: EQUIPMENT GROUND
- 1AB: GAS VALVE
- 1AC: PRESSURE SWITCH
- 1AD: KONTAK

- NOTES**
1. RE-ATTACH WIRE AS PER THE SAME SIZE AND TYPE OF TERMINALS AS SHOWN IN THE ORIGINAL WIRING DIAGRAM. USE THE SAME WIRE COLOR FOR ALL LOW VOLTAGE FIELD CONNECTIONS.
 2. IF OPTIONAL ECONOMIZERS ARE INSTALLED REMOVE ECON FLM JUMPER AND PLUG IN THE WIRE FROM ECONOMIZER TO THE ECONOMIZER TERMINAL. FURTHER DETALS ON ADJUSTING MOTOR, FREEZE PROTECTION SWITCH, AND ASSOCIATED WIRING ARE OPTIONAL.
 3. REMOVE BLACK JUMPER WIRE TO COMMON TERMINAL.
 4. USE BUDD'S 1.2. 3.3 AND ASSOCIATED WIRING ARE OPTIONAL.
 5. IF A SWITCH OR SENSITIVE DEVICE IS INSTALLED, APPLY A JUMPER PLUG AT THE LAST WIRE TERMINAL IN A SERIES. PLUG IN JUMPER PLUG ON THE JUMPER PLUG WITH A NORMALLY CLOSED DRY CONTACT IN SERIES WITH THE WIRE.
 6. ECONOMIZER CONTROL, AVAILABLE.

Wiring is subject to change. Always refer to the wiring diagram on the unit for the most up-to-date wiring.

UNIT WIRING DIAGRAMS



WARNING

HIGH VOLTAGE!
 DISCONNECT ALL POWER BEFORE SERVICING OR INSTALLING THIS UNIT.
 MULTIPLE POWER SOURCES MAY BE PRESENT. FAILURE TO DO SO MAY
 CAUSE PROPERTY DAMAGE, PERSONAL INJURY OR DEATH.

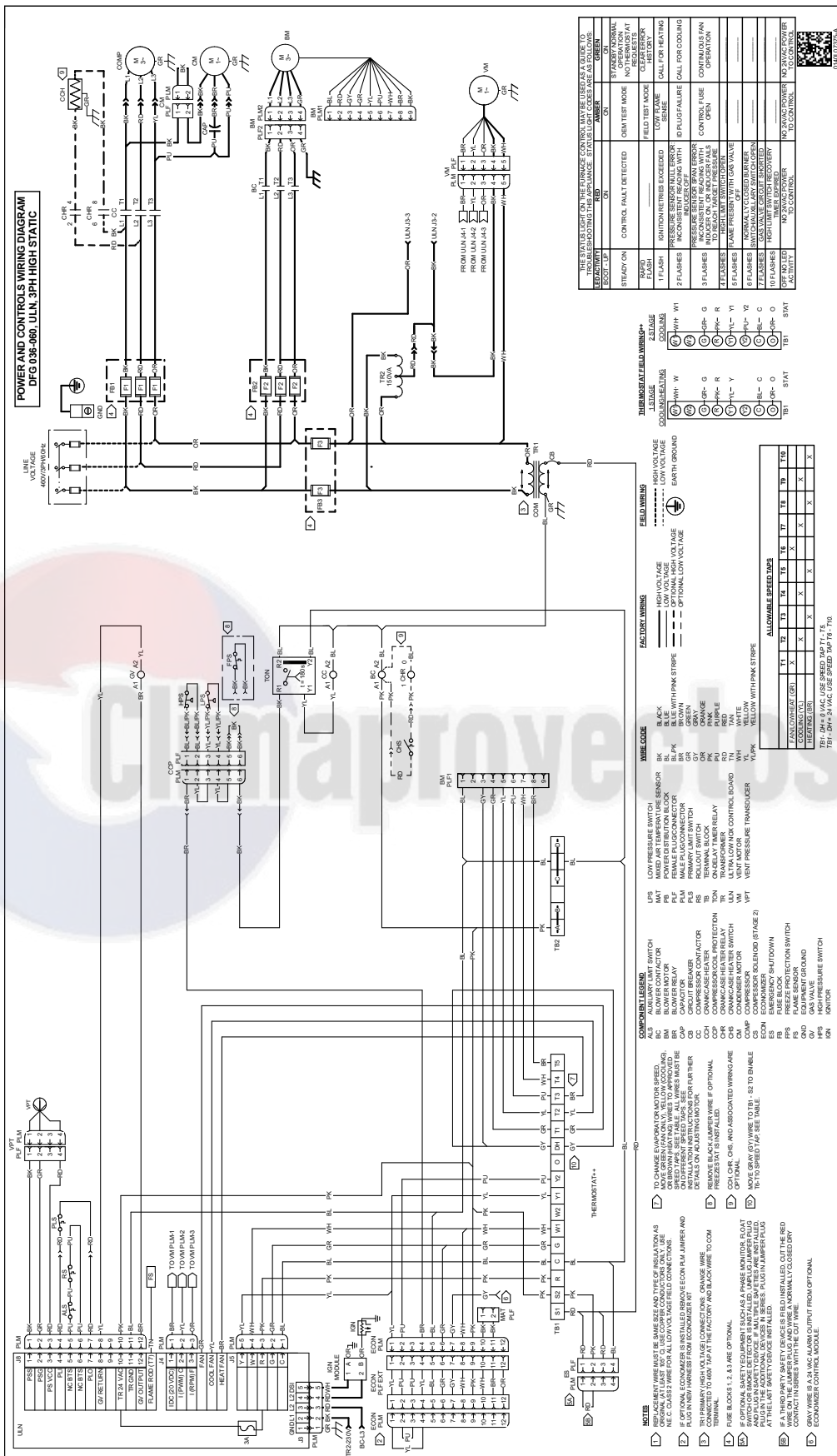

THE STATUS LIGHT ON THE ENTRANCE CONTROL MAY BE USED AS A GUIDE TO OPERATION. THE STATUS LIGHT IS GREEN FOR NORMAL OPERATION, RED FOR A FAULT CONDITION, AND FLASHES FOR A SERVICE CALL.

STATUS LIGHT	OPERATION
ON	OPERATION
FLASH	FAULT CONDITION
FLASH	SERVICE CALL

FLAME FAILURE

FLAME FAILURE	OPERATION
ON	OPERATION
FLASH	FAULT CONDITION
FLASH	SERVICE CALL

FLAME FAILURE

FLAME FAILURE	OPERATION
ON	OPERATION
FLASH	FAULT CONDITION
FLASH	SERVICE CALL

FLAME FAILURE

FLAME FAILURE	OPERATION
ON	OPERATION
FLASH	FAULT CONDITION
FLASH	SERVICE CALL

FLAME FAILURE

FLAME FAILURE	OPERATION
ON	OPERATION
FLASH	FAULT CONDITION
FLASH	SERVICE CALL

FLAME FAILURE

FLAME FAILURE	OPERATION
ON	OPERATION
FLASH	FAULT CONDITION
FLASH	SERVICE CALL

FLAME FAILURE

FLAME FAILURE	OPERATION
ON	OPERATION
FLASH	FAULT CONDITION
FLASH	SERVICE CALL

FLAME FAILURE

FLAME FAILURE	OPERATION
ON	OPERATION
FLASH	FAULT CONDITION
FLASH	SERVICE CALL

FLAME FAILURE

FLAME FAILURE	OPERATION
ON	OPERATION
FLASH	FAULT CONDITION
FLASH	SERVICE CALL

FLAME FAILURE

FLAME FAILURE	OPERATION
ON	OPERATION
FLASH	FAULT CONDITION
FLASH	SERVICE CALL

Wiring is subject to change. Always refer to the wiring diagram on the unit for the most up-to-date wiring.

WARNING

HIGH VOLTAGE!

DISCONNECT ALL POWER BEFORE SERVICING OR INSTALLING THIS UNIT.

MULTIPLE POWER SOURCES MAY BE PRESENT. FAILURE TO DO SO MAY CAUSE PROPERTY DAMAGE, PERSONAL INJURY OR DEATH.

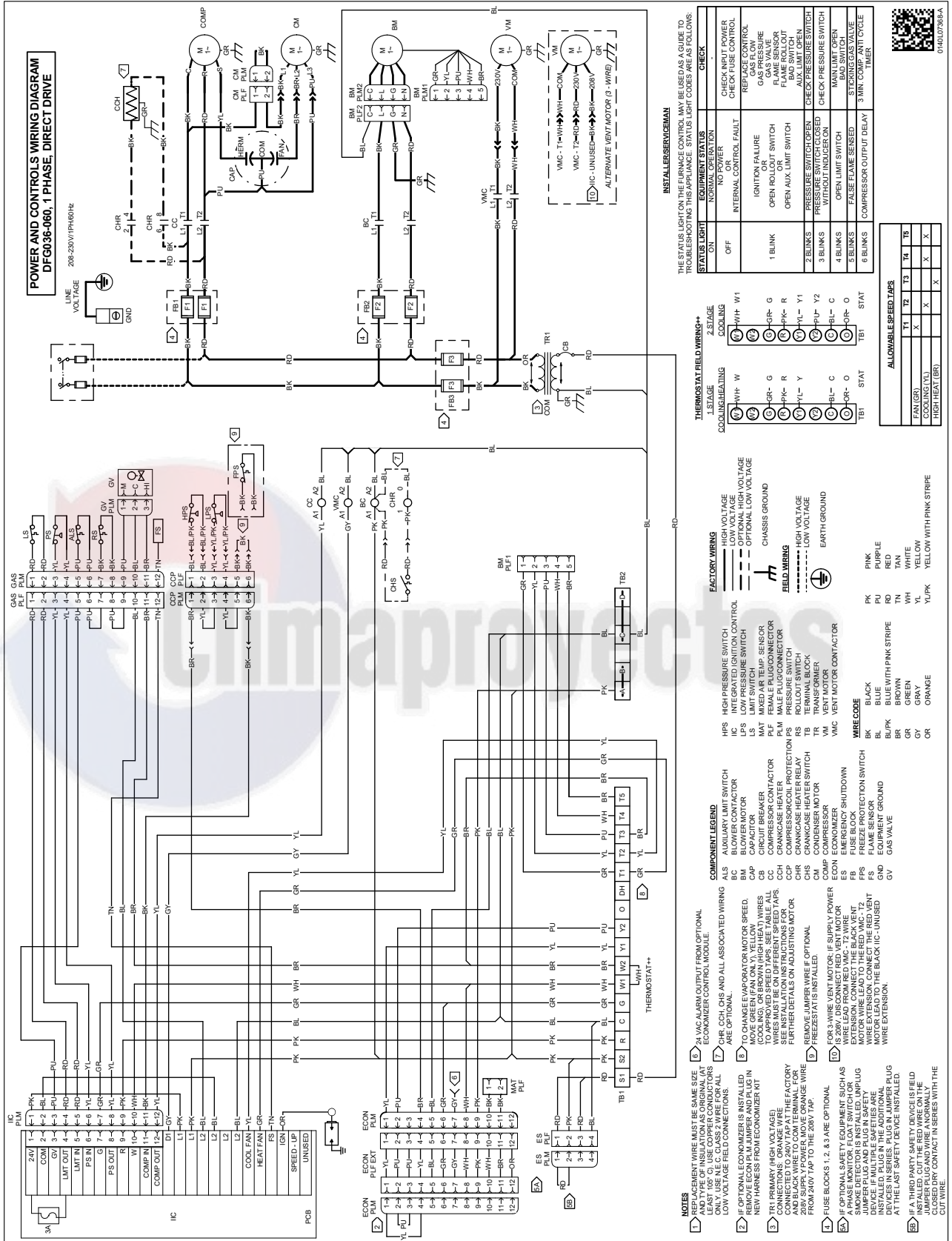



Wiring is subject to change. Always refer to the wiring diagram on the unit for the most up-to-date wiring.

UNIT WIRING DIAGRAMS

DFG0603/4/7D

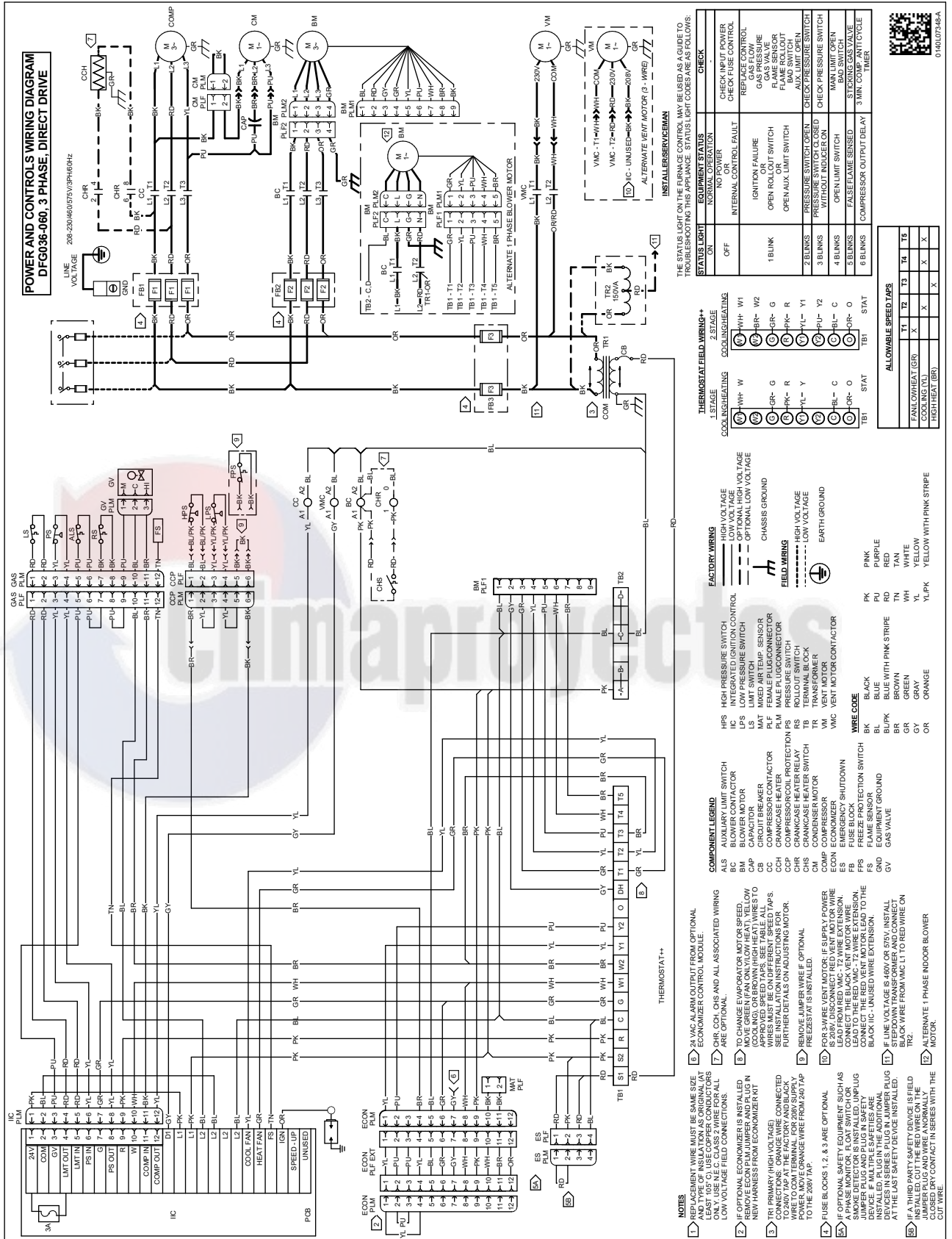
WARNING
HIGH VOLTAGE!
 DISCONNECT ALL POWER BEFORE SERVICING OR INSTALLING THIS UNIT.
 MULTIPLE POWER SOURCES MAY BE PRESENT. FAILURE TO DO SO MAY
 CAUSE PROPERTY DAMAGE, PERSONAL INJURY OR DEATH.



Wiring is subject to change. Always refer to the wiring diagram on the unit for the most up-to-date wiring.

UNIT WIRING DIAGRAMS

DFG0603/4/7W

WARNING

HIGH VOLTAGE!

DISCONNECT ALL POWER BEFORE SERVICING OR INSTALLING THIS UNIT.
MULTIPLE POWER SOURCES MAY BE PRESENT. FAILURE TO DO SO MAY
CAUSE PROPERTY DAMAGE, PERSONAL INJURY OR DEATH.

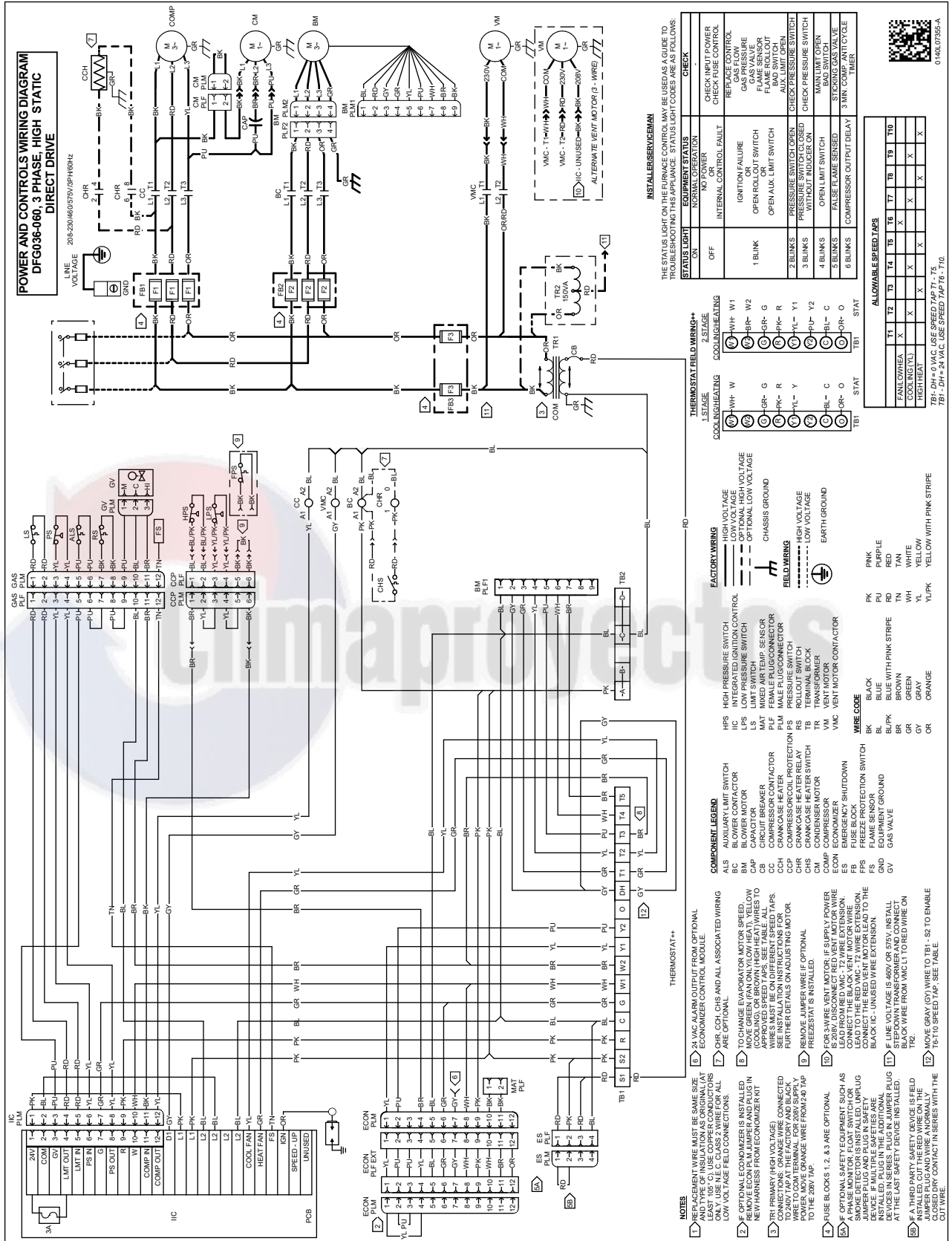

Wiring is subject to change. Always refer to the wiring diagram on the unit for the most up-to-date wiring.

DRC WIRING DIAGRAMS





WARNING

HIGH VOLTAGE!
 DISCONNECT ALL POWER BEFORE SERVICING OR INSTALLING THIS UNIT.
 MULTIPLE POWER SOURCES MAY BE PRESENT. FAILURE TO DO SO MAY
 CAUSE PROPERTY DAMAGE, PERSONAL INJURY OR DEATH.

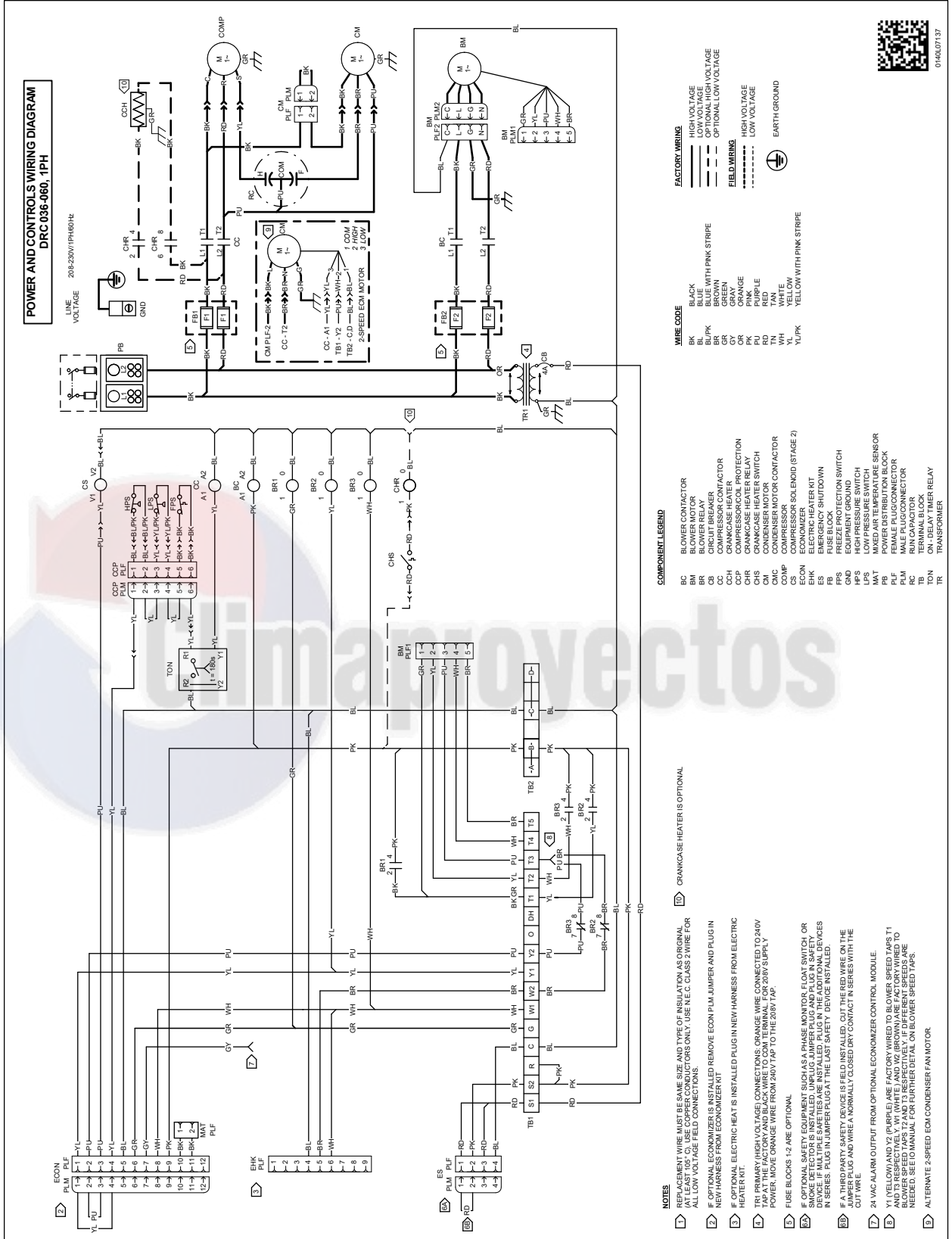

9146607137

Wiring is subject to change. Always refer to the wiring diagram on the unit for the most up-to-date wiring.

WARNING

HIGH VOLTAGE!
 DISCONNECT ALL POWER BEFORE SERVICING OR INSTALLING THIS UNIT.
 MULTIPLE POWER SOURCES MAY BE PRESENT. FAILURE TO DO SO MAY
 CAUSE PROPERTY DAMAGE, PERSONAL INJURY OR DEATH.

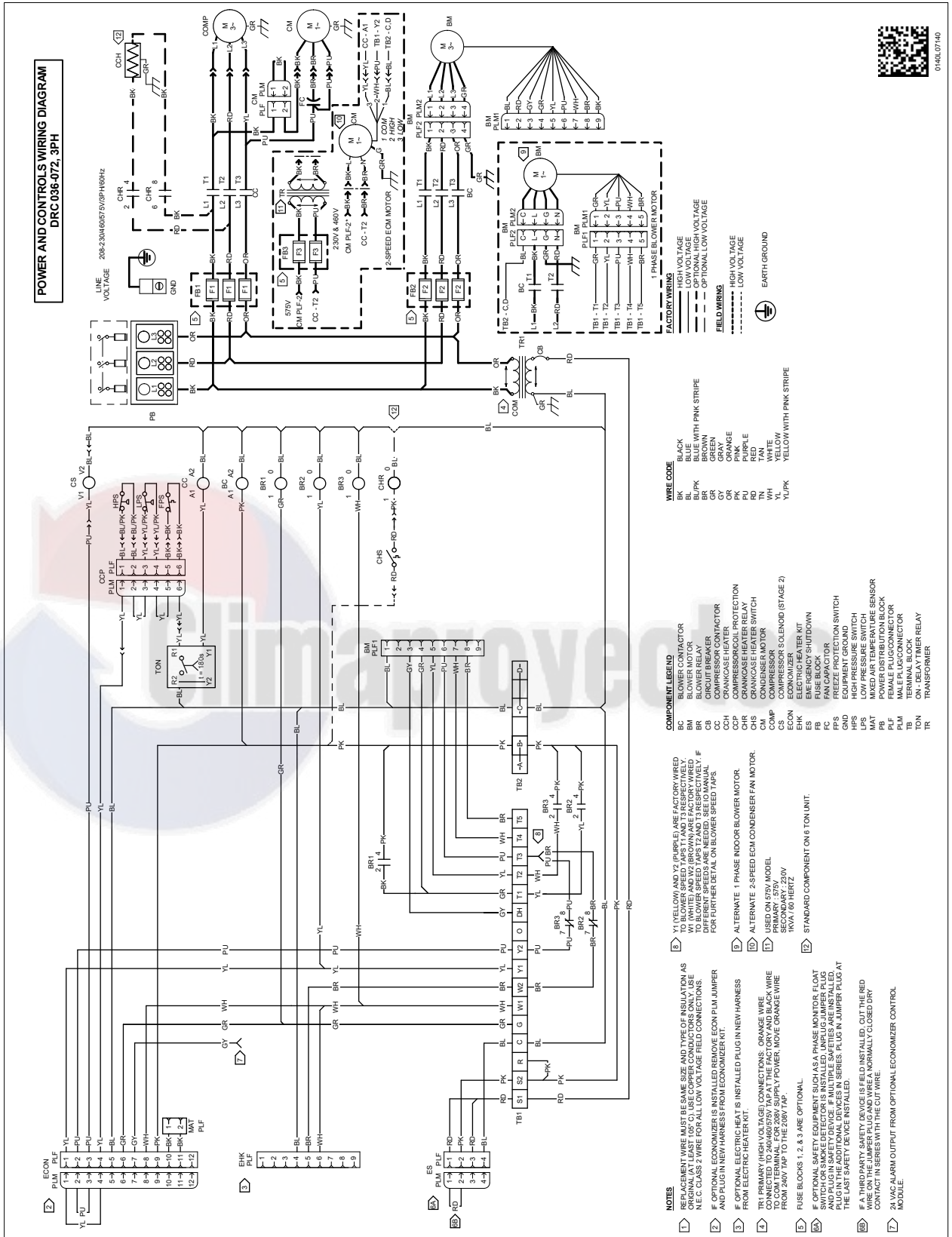

Wiring is subject to change. Always refer to the wiring diagram on the unit for the most up-to-date wiring.



WARNING

HIGH VOLTAGE!
 DISCONNECT ALL POWER BEFORE SERVICING OR INSTALLING THIS UNIT.
 MULTIPLE POWER SOURCES MAY BE PRESENT. FAILURE TO DO SO MAY
 CAUSE PROPERTY DAMAGE, PERSONAL INJURY OR DEATH.

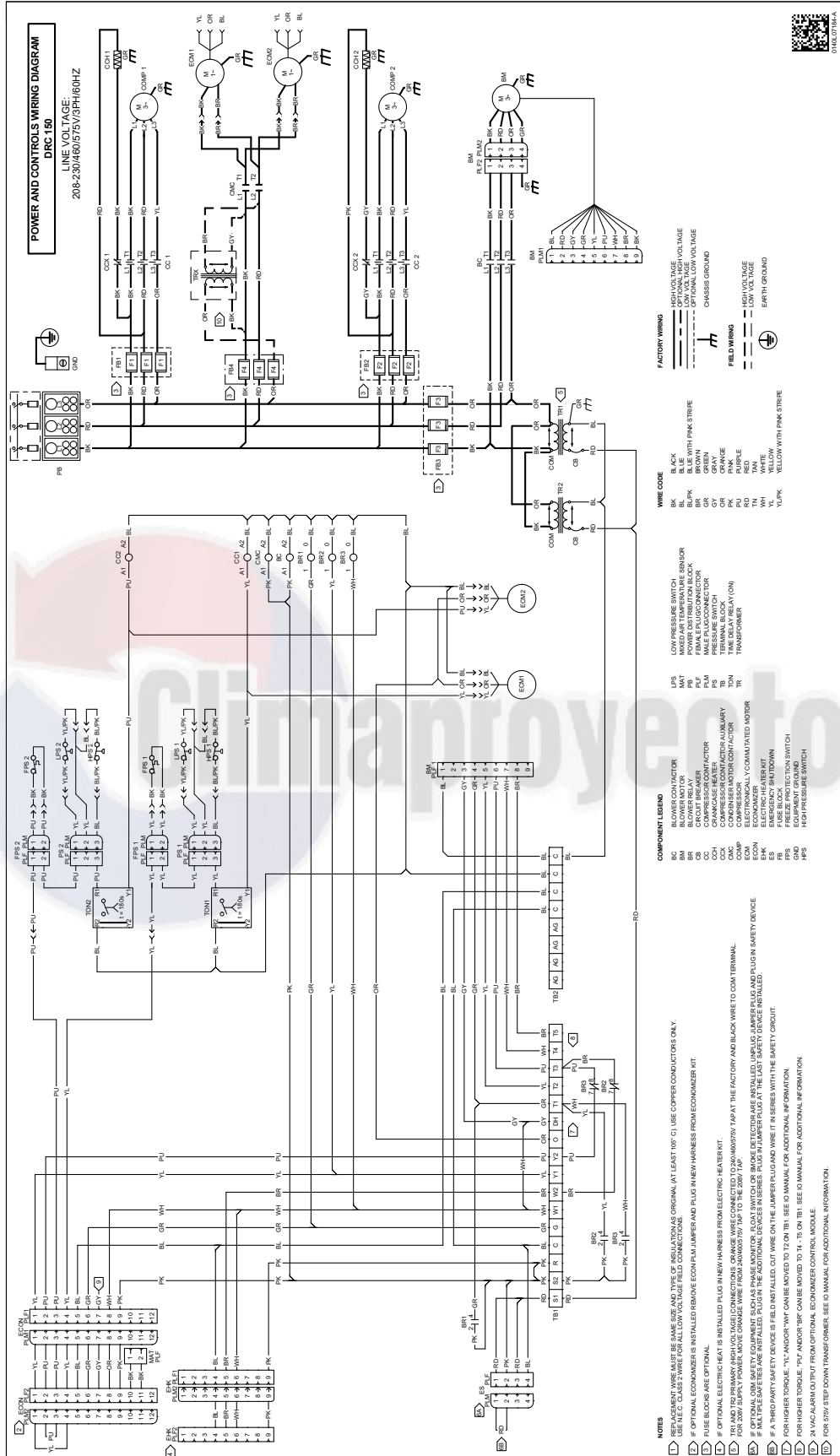

Wiring is subject to change. Always refer to the wiring diagram on the unit for the most up-to-date wiring.

WARNING

HIGH VOLTAGE!
DISCONNECT ALL POWER BEFORE SERVICING OR INSTALLING THIS UNIT.
MULTIPLE POWER SOURCES MAY BE PRESENT. FAILURE TO DO SO MAY
CAUSE PROPERTY DAMAGE, PERSONAL INJURY OR DEATH.

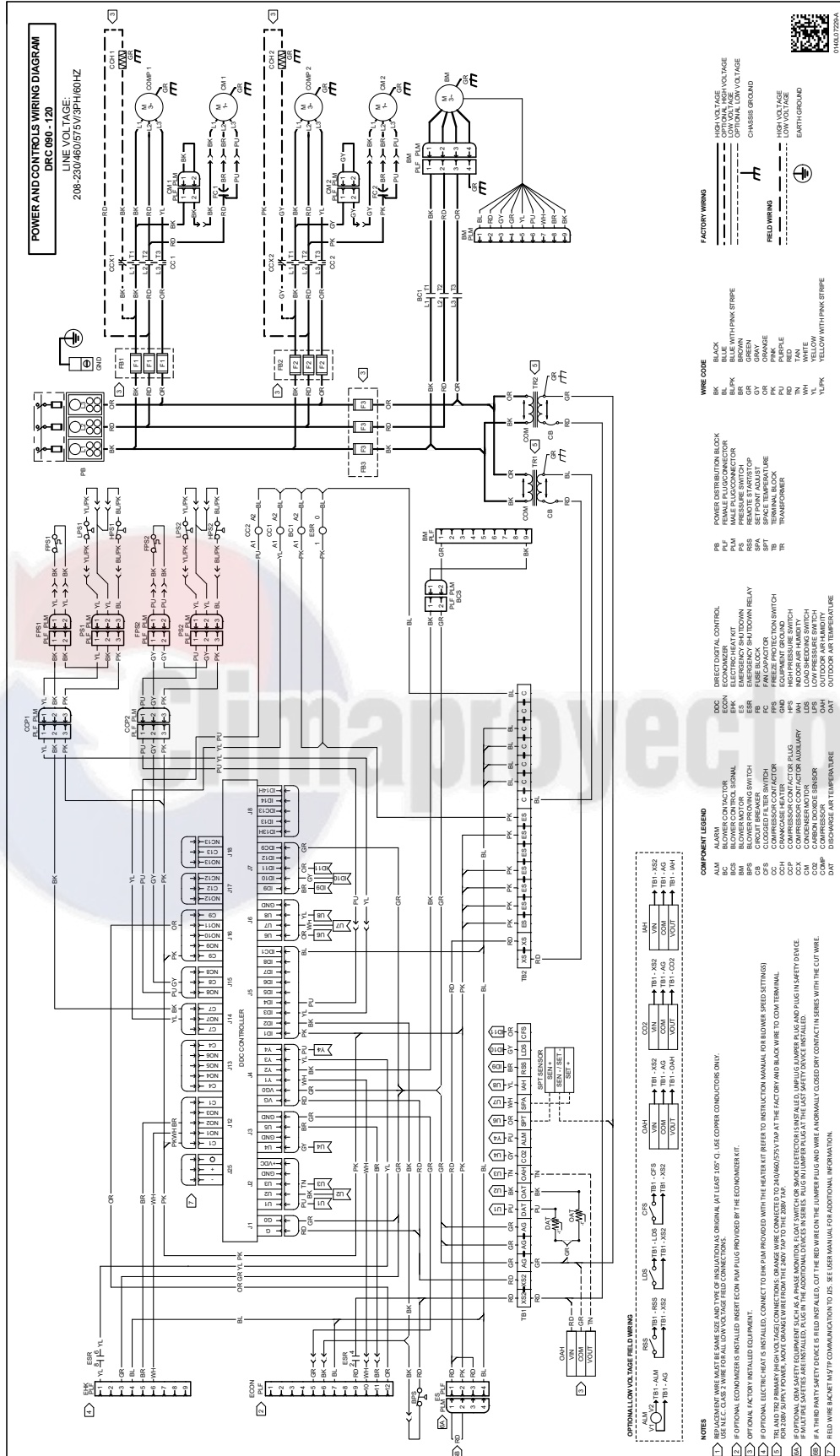

Wiring is subject to change. Always refer to the wiring diagram on the unit for the most up-to-date wiring.



WARNING

HIGH VOLTAGE!
 DISCONNECT ALL POWER BEFORE SERVICING OR INSTALLING THIS UNIT.
 MULTIPLE POWER SOURCES MAY BE PRESENT. FAILURE TO DO SO MAY
 CAUSE PROPERTY DAMAGE, PERSONAL INJURY OR DEATH.

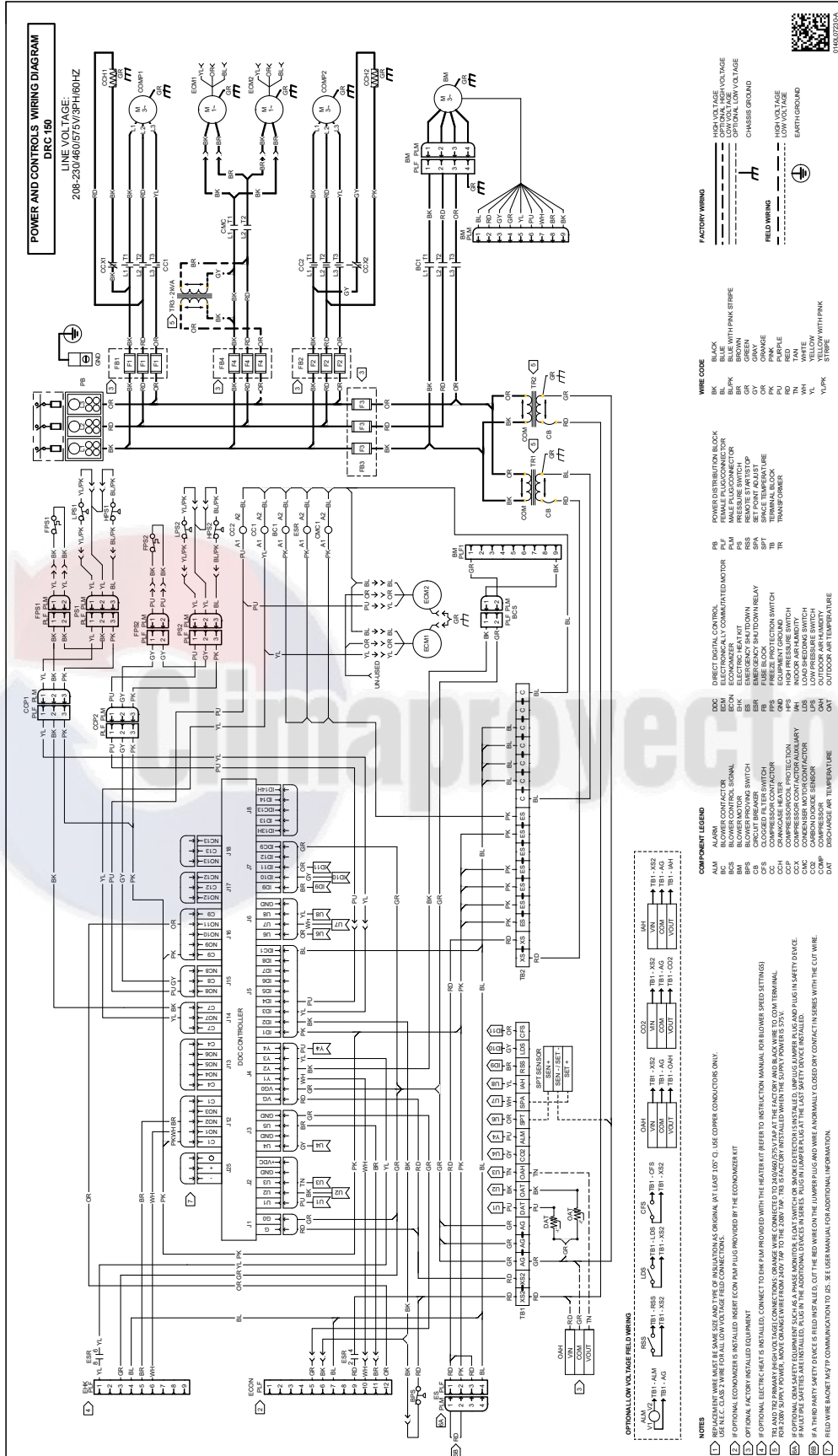

Wiring is subject to change. Always refer to the wiring diagram on the unit for the most up-to-date wiring.

DRG WIRING DIAGRAMS





WARNING

HIGH VOLTAGE!
DISCONNECT ALL POWER BEFORE SERVICING OR INSTALLING THIS UNIT.
MULTIPLE POWER SOURCES MAY BE PRESENT. FAILURE TO DO SO MAY
CAUSE PROPERTY DAMAGE, PERSONAL INJURY OR DEATH.

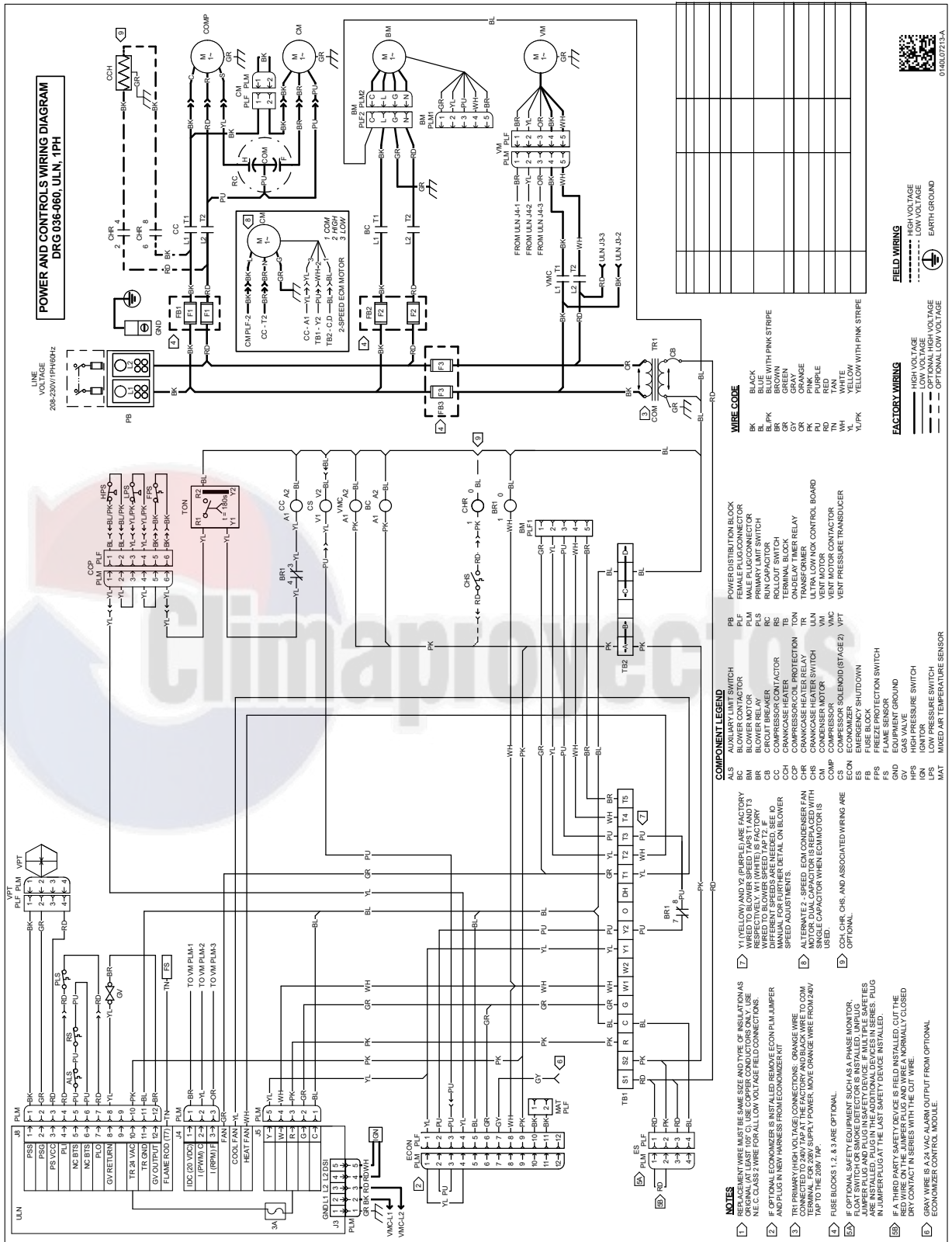

Wiring is subject to change. Always refer to the wiring diagram on the unit for the most up-to-date wiring.



WARNING

HIGH VOLTAGE!
DISCONNECT ALL POWER BEFORE SERVICING OR INSTALLING THIS UNIT.
MULTIPLE POWER SOURCES MAY BE PRESENT. FAILURE TO DO SO MAY
CAUSE PROPERTY DAMAGE, PERSONAL INJURY OR DEATH.

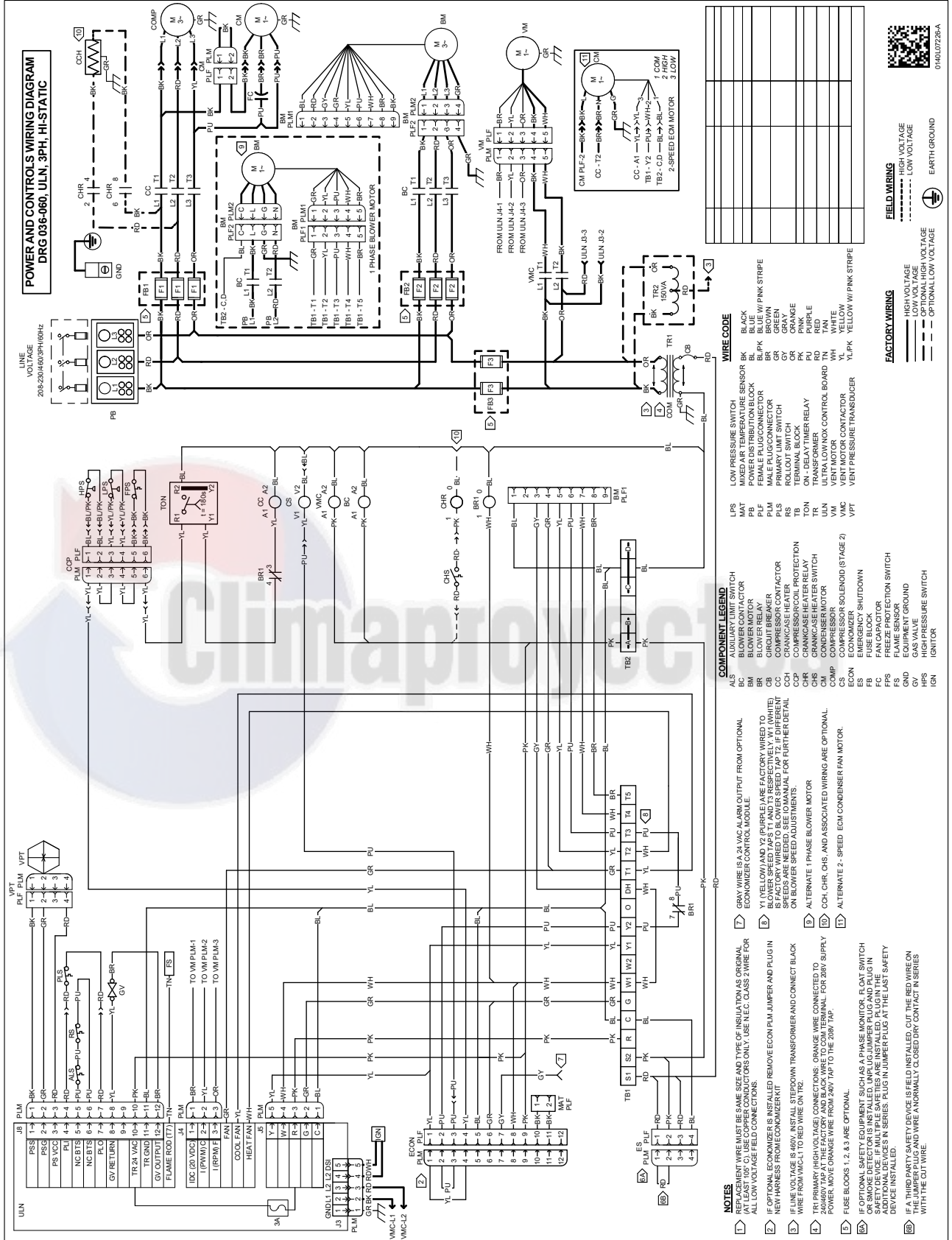

04600226A

Wiring is subject to change. Always refer to the wiring diagram on the unit for the most up-to-date wiring.

WARNING

HIGH VOLTAGE!

DISCONNECT ALL POWER BEFORE SERVICING OR INSTALLING THIS UNIT.
MULTIPLE POWER SOURCES MAY BE PRESENT. FAILURE TO DO SO MAY
CAUSE PROPERTY DAMAGE, PERSONAL INJURY OR DEATH.

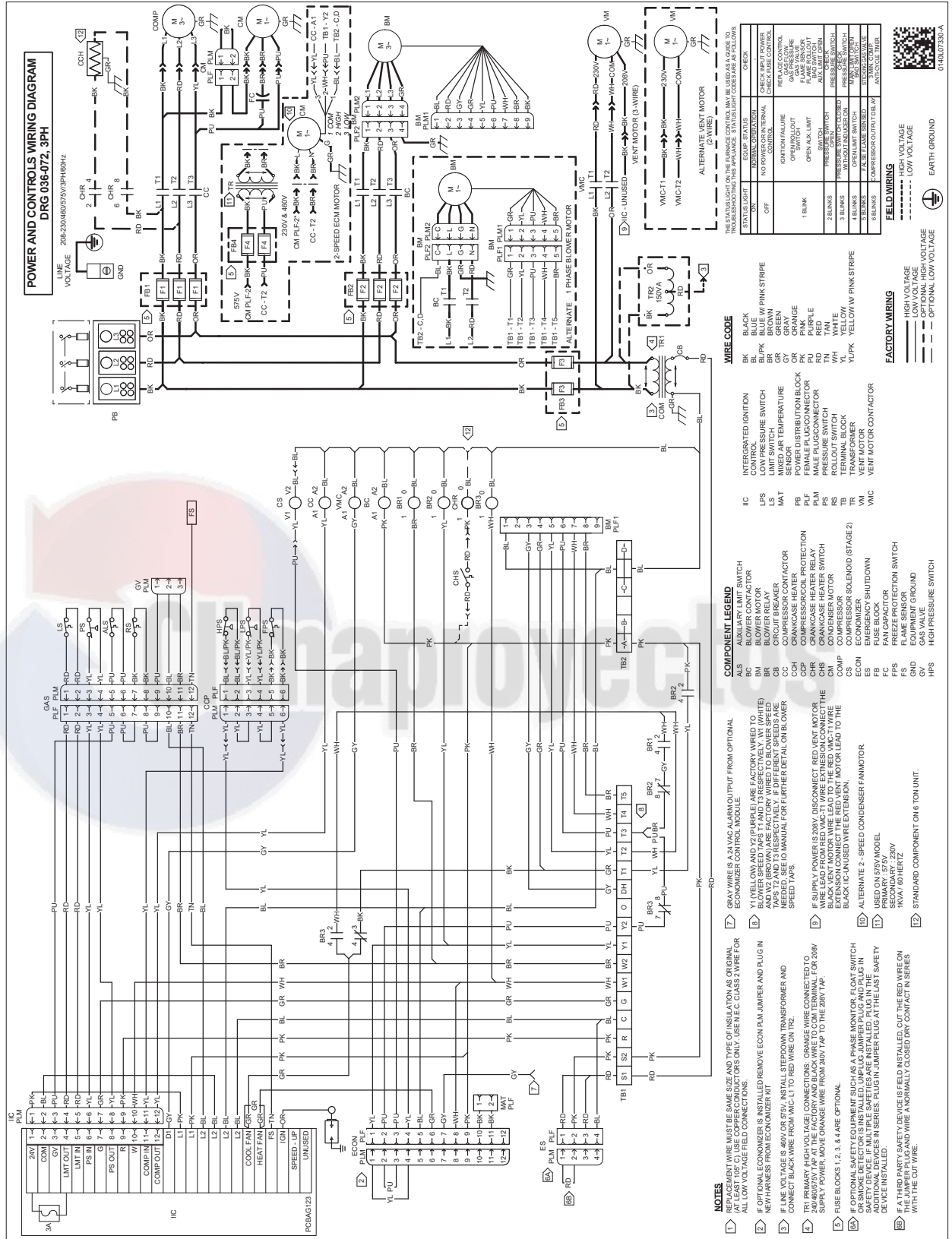

THE STATUS LIGHT ON THE FURNACE CONTROL MAY BE USED AS A GUIDE TO TROUBLESHOOTING THE APPLANCE. STATUS LIGHT COLORS ARE AS FOLLOWS:

STATUS LIGHT	COULD BE STATUS	CHECK
OFF	NO POWER OR INTERNAL CONTROL	CHECK W/WT POWER CHECK CODE CONTROL
1 BLINK	IGNITION FAILURE	NO GAS VALVE OPENING
2 BLINKS	FLAME FAILURE	NO GAS VALVE OPENING
3 BLINKS	PRESSURE SWITCH FAILURE	NO GAS VALVE OPENING
4 BLINKS	NO POWER TO PRESSURE SWITCH	NO GAS VALVE OPENING
5 BLINKS	OPEN AIR LIMIT	NO GAS VALVE OPENING
6 BLINKS	OPEN AIR SWITCH WITHOUT INDUCTION	NO GAS VALVE OPENING
7 BLINKS	COMPRESSOR OUTPUT DELAY	NO GAS VALVE OPENING
8 BLINKS	COMPRESSOR OUTPUT DELAY	NO GAS VALVE OPENING

FIELD WIRING

----- HIGH VOLTAGE
----- LOW VOLTAGE
----- EARTH GROUND

FACTORY WIRING

----- HIGH VOLTAGE
----- OPTIONAL HIGH VOLTAGE
----- OPTIONAL LOW VOLTAGE

COMPONENT LEGEND

ALS	AUXILIARY LIMIT SWITCH
BLM	BLOWER MOTOR
CB	CIRCUIT BREAKER
CC	COMPRESSOR CONTACTOR
CH	CRANKCASE HEATER
CHR	CRANKCASE HEATER RELAY
CM	CONDENSER MOTOR
CS	COMPRESSOR SOLENOID (STAGE 2)
ECON	ECONOMIZER
ES	EMERGENCY SHUTDOWN
FC	FAN CAPACITOR
FPS	FREEZE PROTECTION SWITCH
FS	FLAME SENSOR
GD	GROUND
GV	GAS VALVE
HPS	HIGH PRESSURE SWITCH

WIRE CODE

BL	BLACK
BL/PK	BLUE W/ PINK STRIPE
BR	BROWN
GY	GRAY
OR	ORANGE
PK	PINK
PU	PURPLE
RD	RED
TR	TERMINAL BLOCK
WH	WHITE
YL	YELLOW
Y/PK	YELLOW W/ PINK STRIPE

NOTES

- REPLACEMENT WIRE MUST BE SAME SIZE AND TYPE OF INSULATION AS ORIGINAL (AT LEAST 105°C). USE COPPER CONDUCTORS ONLY. USE N.E.C. CLASS 2 WIRE FOR ALL LOW VOLTAGE FIELD CONNECTIONS.
- IF OPTIONAL ECONOMIZER IS INSTALLED REMOVE ECON PLM JUMPER AND PLUG IN NEW WIRE FROM ECONOMIZER KIT.
- CONNECT BLACK WIRE FROM WMC-11 TO RED WIRE ON TR1.
- TR1 TERMINAL BLOCK IS LOCATED ON THE RIGHT SIDE OF THE ECONOMIZER KIT. SUPPLY POWER. MOVE ORANGE WIRE FROM 240V TAP TO THE 208V TAP.
- FUSE BLOCKS 1, 2, 3, 4, 4 ARE OPTIONAL.
- IF OPTIONAL SAFETY EQUIPMENT SUCH AS A PHASE MONITOR, FLOAT SWITCH OR SMOKE DETECTOR IS INSTALLED, UNPLUG JUMPER PLUG AND PLUG IN SAFETY DEVICE. IF MULTIPLE SAFETIES ARE INSTALLED, PLUG IN THE SAFETY DEVICE IN SERIES. PLUG IN SERIES PLUG JUMPER PLUG AT THE LAST SAFETY DEVICE INSTALLED.
- IF A THIRD PARTY SAFETY DEVICE IS FIELD INSTALLED, CUT THE RED WIRE ON THE JUMPER PLUG AND WIRE A NORMALLY CLOSED DRY CONTACT IN SERIES WITH THE DRY WIRE.

REPLACEMENT WIRE MUST BE SAME SIZE AND TYPE OF INSULATION AS ORIGINAL (AT LEAST 105°C). USE COPPER CONDUCTORS ONLY. USE N.E.C. CLASS 2 WIRE FOR ALL LOW VOLTAGE FIELD CONNECTIONS.

- GRAY WIRE IS A 24 VAC ALARM OUTPUT FROM OPTIONAL ECONOMIZER CONTROL MODULE.
- Y1 (YELLOW) AND Y2 (PURPLE) ARE FACTORY WIRING TO BLOWER SPEED TAPS T1 AND T3 RESPECTIVELY. Y1 (WHITE) AND Y2 (PURPLE) ARE FACTORY WIRING TO BLOWER SPEED TAPS T2 AND T3 RESPECTIVELY. IF DIFFERENT SPEEDS ARE NEEDED, SEE TO MANUAL FOR FURTHER DETAIL ON BLOWER SPEED TAPS.
- IF SUPPLY POWER IS 208V, DISCONNECT RED VENT MOTOR WIRE LEAD FROM RED WMC-11 WIRE EXTENSION. CONNECT THE RED WIRE FROM WMC-11 WIRE EXTENSION TO THE RED WIRE LEAD TO THE BLOWER MOTOR.
- BLACK IC-UNUSED WIRE EXTENSION.
- ALTERNATE 2 - SPEED CONDENSER FAN MOTOR.
- USED ON F534 MODEL.
- PRIMARY: 57.5V
- SECONDARY: 230V
- WVA1 60 HERTZ.
- STANDARD COMPONENT ON 6 TON UNIT.



WARNING

HIGH VOLTAGE!
DISCONNECT ALL POWER BEFORE SERVICING OR INSTALLING THIS UNIT.
MULTIPLE POWER SOURCES MAY BE PRESENT. FAILURE TO DO SO MAY
CAUSE PROPERTY DAMAGE, PERSONAL INJURY OR DEATH.

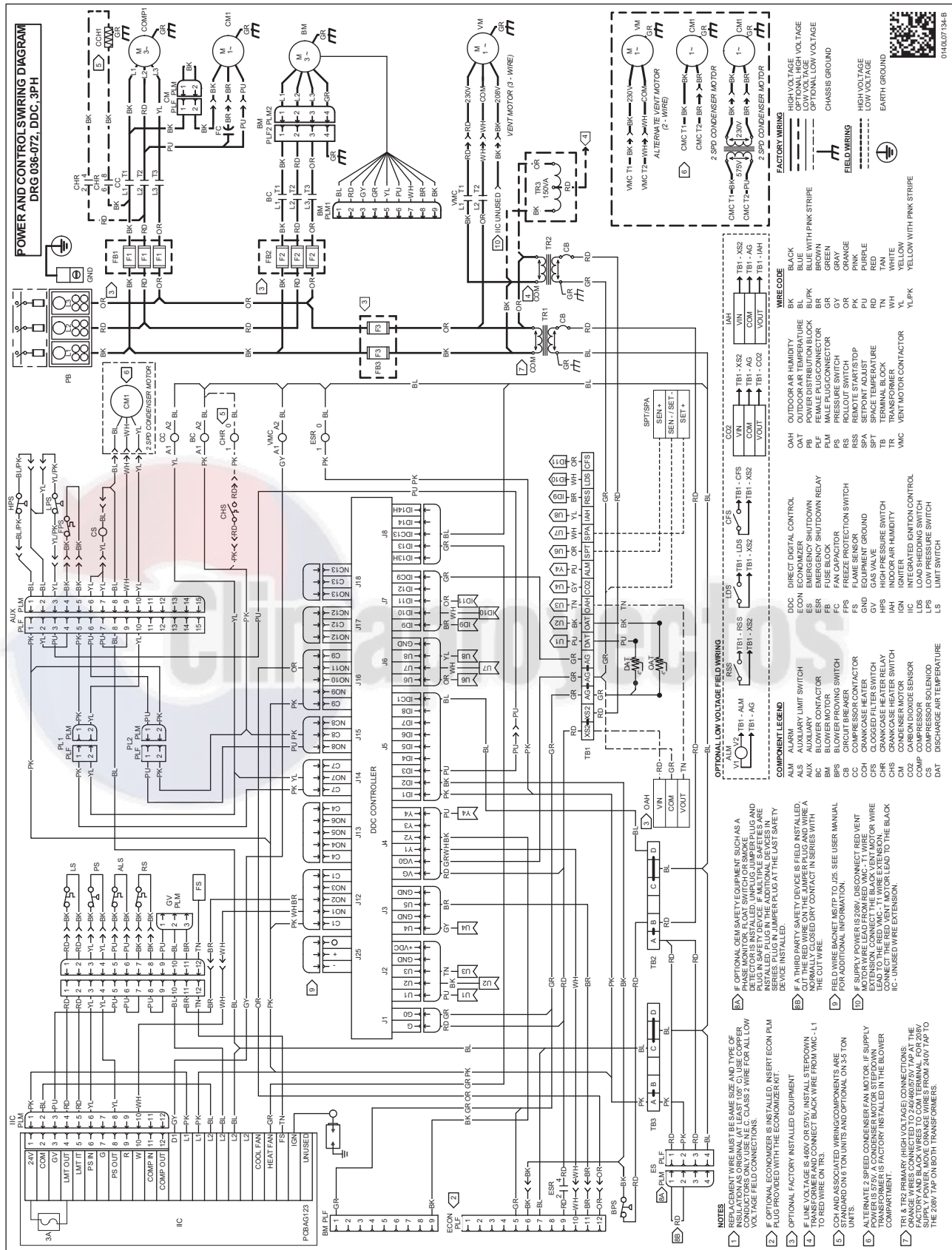

Wiring is subject to change. Always refer to the wiring diagram on the unit for the most up-to-date wiring.

WARNING

HIGH VOLTAGE!

DISCONNECT ALL POWER BEFORE SERVICING OR INSTALLING THIS UNIT.
MULTIPLE POWER SOURCES MAY BE PRESENT. FAILURE TO DO SO MAY
CAUSE PROPERTY DAMAGE, PERSONAL INJURY OR DEATH.

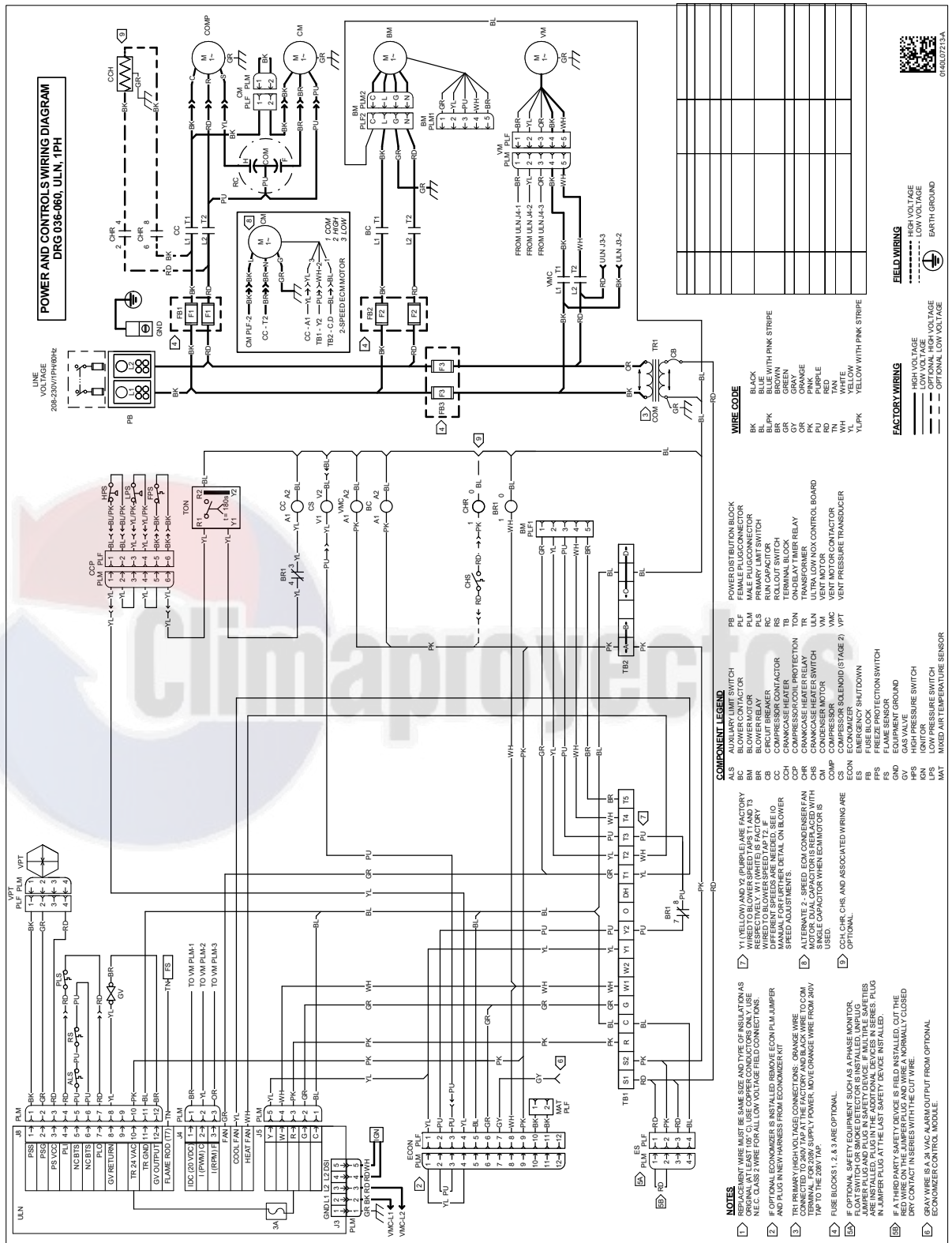

Wiring is subject to change. Always refer to the wiring diagram on the unit for the most up-to-date wiring.

DRH WIRING DIAGRAMS



WARNING

HIGH VOLTAGE!
 DISCONNECT ALL POWER BEFORE SERVICING OR INSTALLING THIS UNIT.
 MULTIPLE POWER SOURCES MAY BE PRESENT. FAILURE TO DO SO MAY
 CAUSE PROPERTY DAMAGE, PERSONAL INJURY OR DEATH.

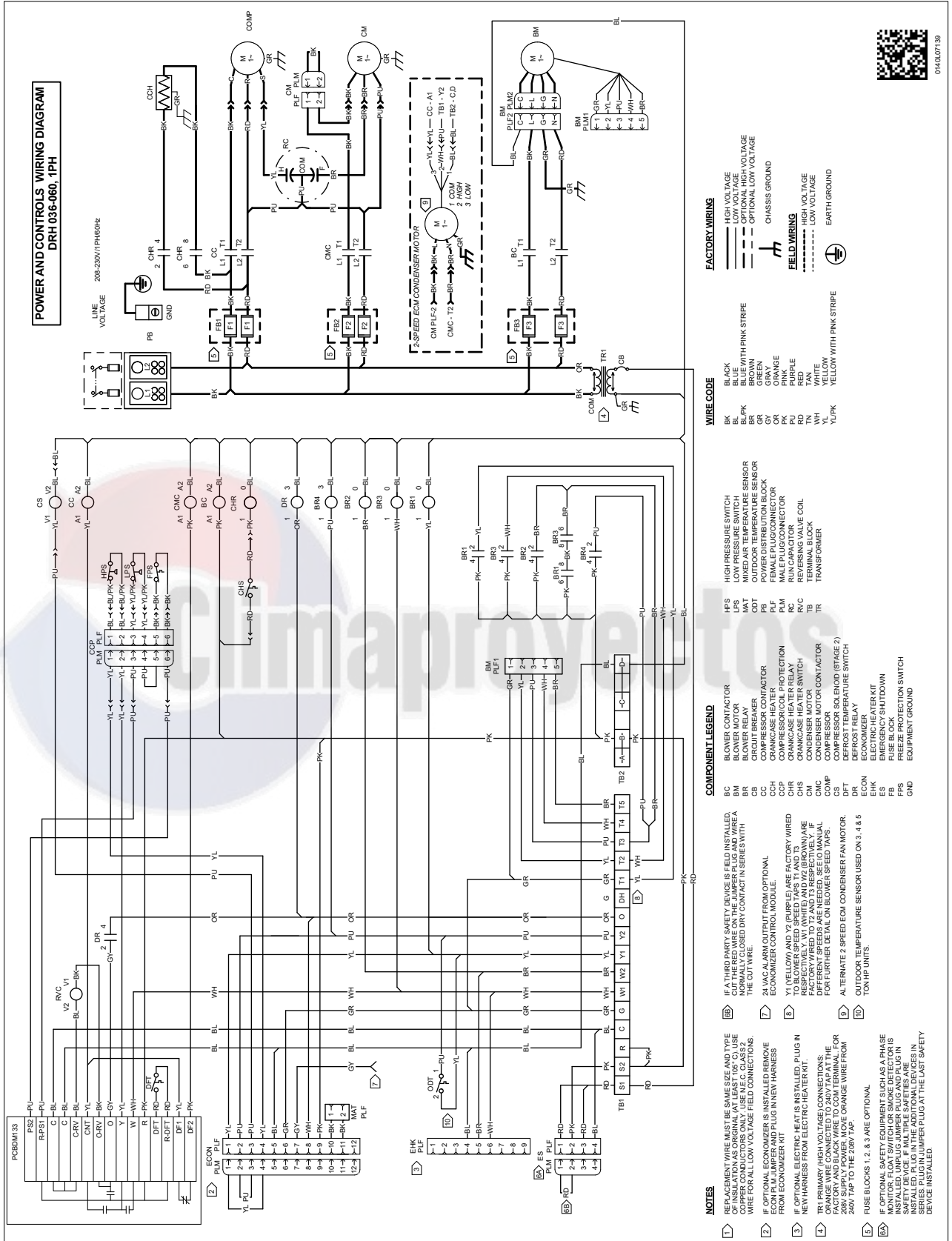

Wiring is subject to change. Always refer to the wiring diagram on the unit for the most up-to-date wiring.



0416207139

WARNING

HIGH VOLTAGE!

DISCONNECT ALL POWER BEFORE SERVICING OR INSTALLING THIS UNIT.
MULTIPLE POWER SOURCES MAY BE PRESENT. FAILURE TO DO SO MAY
CAUSE PROPERTY DAMAGE, PERSONAL INJURY OR DEATH.

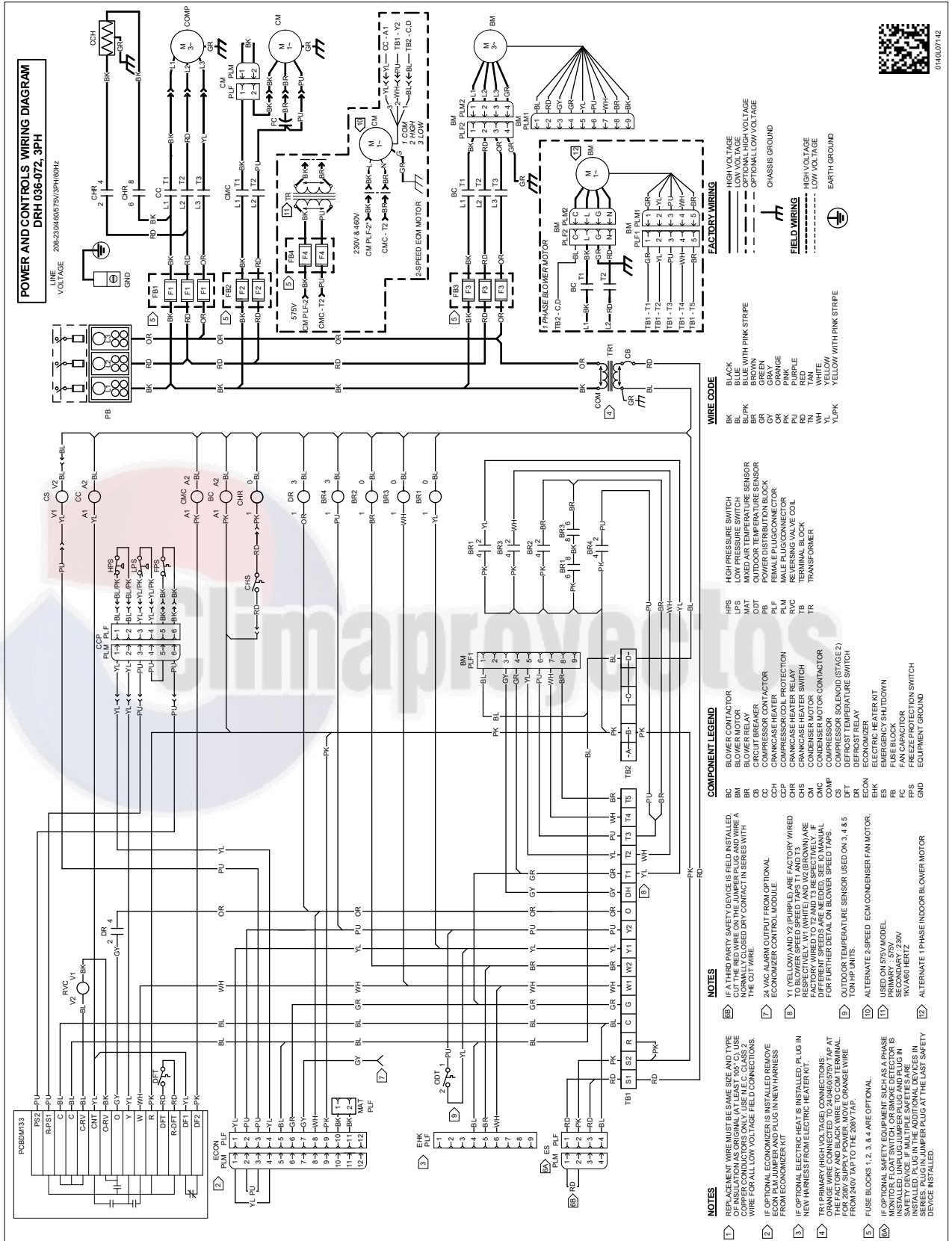

04H030714Z

Wiring is subject to change. Always refer to the wiring diagram on the unit for the most up-to-date wiring.



WARNING

HIGH VOLTAGE!
 DISCONNECT ALL POWER BEFORE SERVICING OR INSTALLING THIS UNIT.
 MULTIPLE POWER SOURCES MAY BE PRESENT. FAILURE TO DO SO MAY
 CAUSE PROPERTY DAMAGE, PERSONAL INJURY OR DEATH.

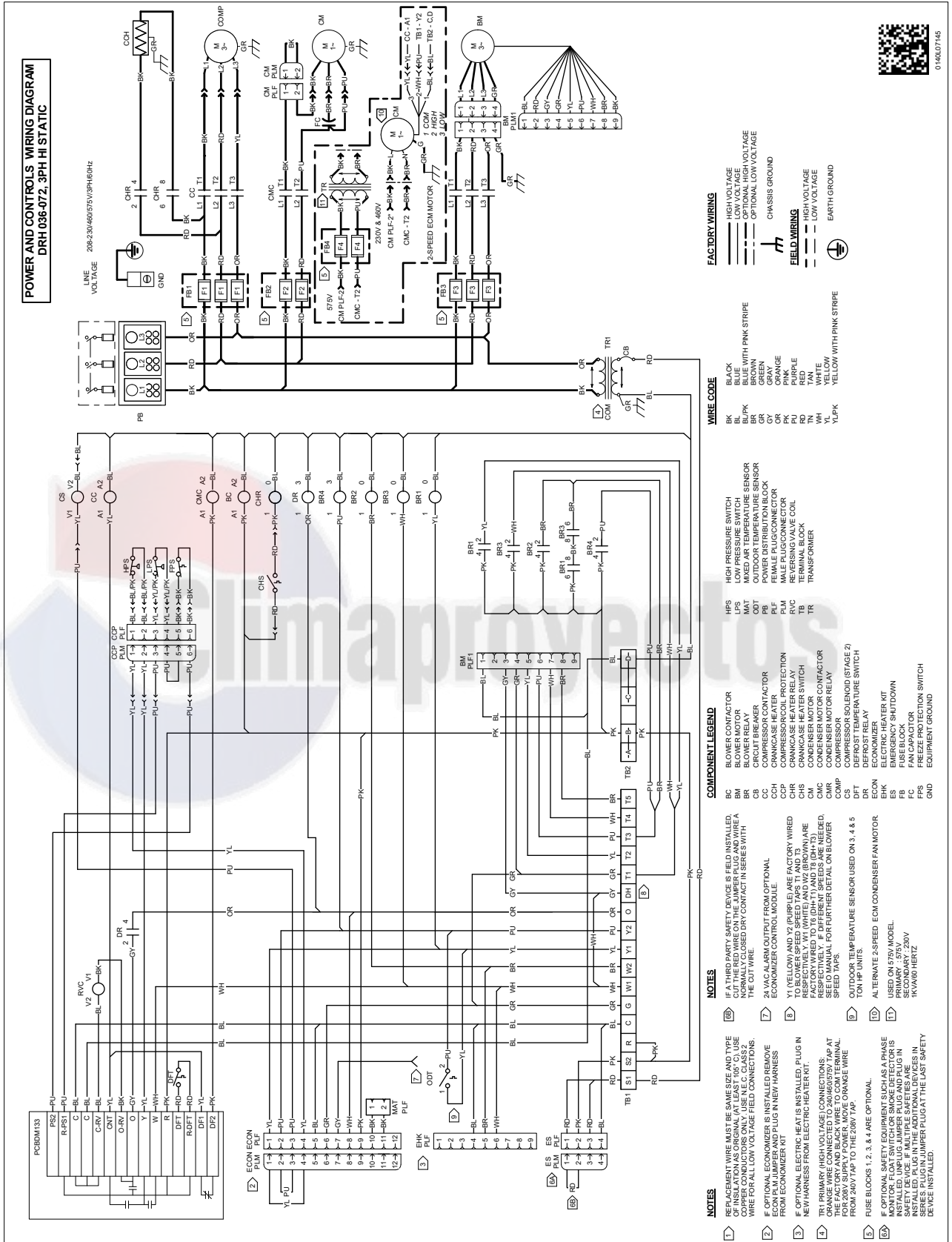

Wiring is subject to change. Always refer to the wiring diagram on the unit for the most up-to-date wiring.



WARNING

HIGH VOLTAGE!
DISCONNECT ALL POWER BEFORE SERVICING OR INSTALLING THIS UNIT.
MULTIPLE POWER SOURCES MAY BE PRESENT. FAILURE TO DO SO MAY
CAUSE PROPERTY DAMAGE, PERSONAL INJURY OR DEATH.

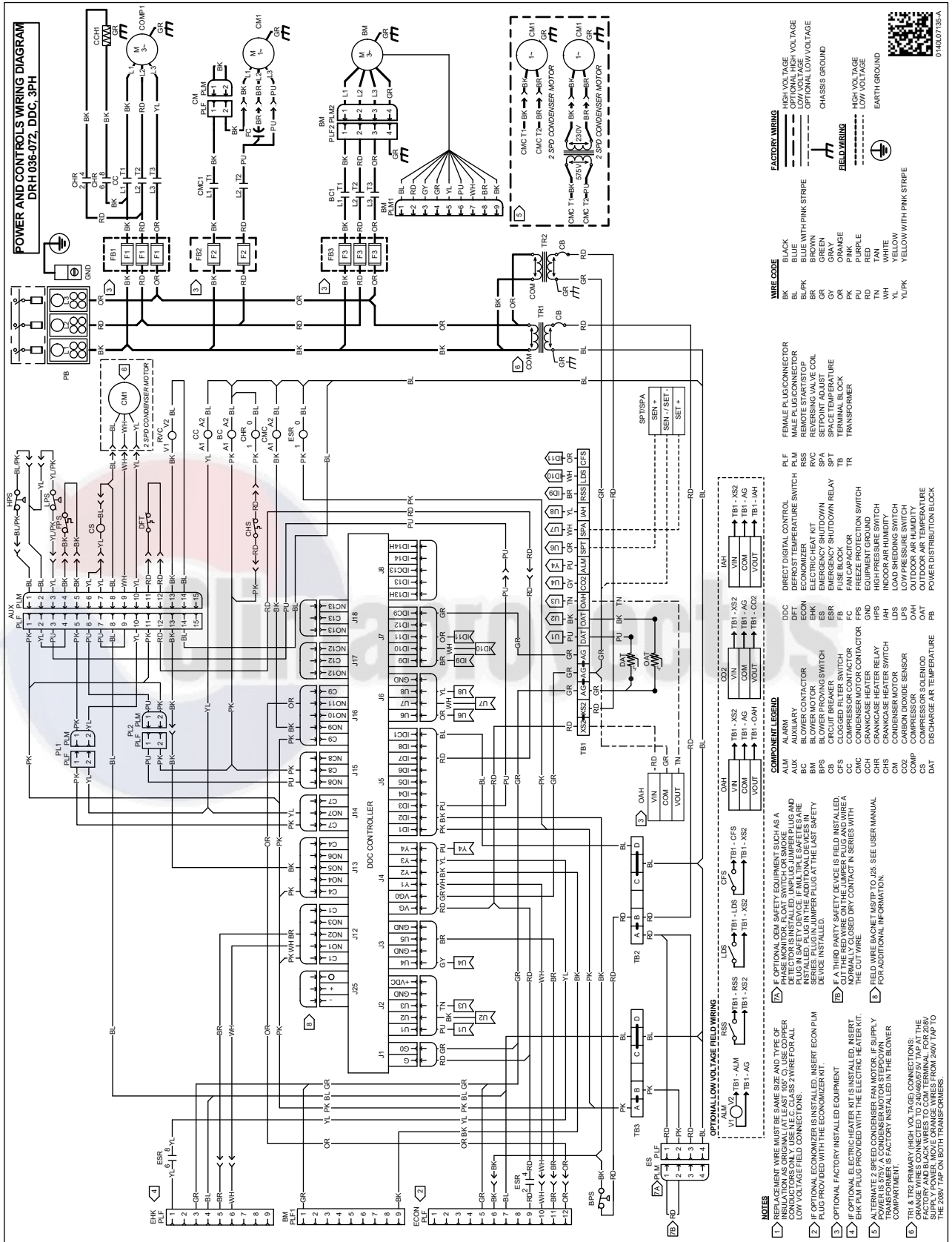

WIRE CODE

BK	BLACK
BL	BLUE
BR	BROWN
GR	GREEN
OR	ORANGE
PK	PINK
PU	PURPLE
RD	RED
TN	TAN
WH	WHITE
YL	YELLOW
Y/PK	YELLOW WITH PINK STRIPE

FACTORY WIRING

- HIGH VOLTAGE
- LOW VOLTAGE
- OPTIONAL HIGH VOLTAGE
- OPTIONAL LOW VOLTAGE
- CHASSIS GROUND

FIELD WIRING

- HIGH VOLTAGE
- LOW VOLTAGE
- EARTH GROUND

COMPONENT LEGEND

DDC	DIRECT DIGITAL CONTROL
DEF	DEFERRED TEMPERATURE SWITCH
ECON	ECONOMIZER
FLM	FAN MOTOR
BLM	BLOWER MOTOR
ESR	EMERGENCY SHUTDOWN
FC	FUSE BLOCK
FC	FAN CAPACITOR
FC	FREEZE PROTECTION SWITCH
CMC	COMPRESSOR CONTACTOR
CH	CRANKCASE HEATER SWITCH
CH	CRANKCASE HEATER SWITCH
CM	CONDENSER MOTOR
CM	CONDENSER MOTOR
CS	COMPRESSOR SENSING
CS	COMPRESSOR SENSING
DAT	DISCHARGE AIR TEMPERATURE

OPTIONAL LOW VOLTAGE FIELD WIRING

Y1, Y2, TB1 - AM, TB1 - AG, TB1 - X2, TB1 - X2, TB1 - X2, TB1 - X2

NOTES

- REPLACEMENT WIRE MUST BE SAME SIZE AND TYPE OF CONDUCTORS AS ORIGINAL. USE A.E.C. CLASS 2 WIRE FOR ALL LOW VOLTAGE FIELD CONNECTIONS.
- IF OPTIONAL ECONOMIZER IS INSTALLED, INSERT ECON P.L.M. PLUG PROVIDED WITH THE ECONOMIZER KIT.
- IF OPTIONAL FACTORY INSTALLED EQUIPMENT (ECONOMIZER, DEFERRED TEMPERATURE SWITCH, EMERGENCY SHUTDOWN, FUSE BLOCK, FREEZE PROTECTION SWITCH, CRANKCASE HEATER SWITCH, COMPRESSOR CONTACTOR, COMPRESSOR SENSING, DISCHARGE AIR TEMPERATURE) IS NOT INSTALLED, INSERT THE C.W.T. WIRE.
- IF A THIRD PARTY SAFETY DEVICE IS FIELD INSTALLED, NORMALY CLOSED DRY CONTACT IN SERIES WITH THE CUT WIRE.
- FIELD WIRE BACKET (M51P) TO J25. SEE USER MANUAL FOR ADDITIONAL INFORMATION.
- CHANGING WIRE CONNECTIONS TO 240V/460V/575V TAP AT THE SUPPLY POWER. MOVE ORANGE WIRES FROM 240V TAP TO THE 208V TAP ON BOTH TRANSFORMERS.

OPTIONAL HIGH VOLTAGE FIELD WIRING

Y1, Y2, TB1 - AM, TB1 - AG, TB1 - X2, TB1 - X2, TB1 - X2, TB1 - X2

OPTIONAL LOW VOLTAGE FIELD WIRING

Y1, Y2, TB1 - AM, TB1 - AG, TB1 - X2, TB1 - X2, TB1 - X2, TB1 - X2

OPTIONAL HIGH VOLTAGE FIELD WIRING

Y1, Y2, TB1 - AM, TB1 - AG, TB1 - X2, TB1 - X2, TB1 - X2, TB1 - X2

OPTIONAL LOW VOLTAGE FIELD WIRING

Y1, Y2, TB1 - AM, TB1 - AG, TB1 - X2, TB1 - X2, TB1 - X2, TB1 - X2

SCHEDULED MAINTENANCE



WARNING

ELECTRICAL SHOCK, FIRE OR EXPLOSION HAZARD
FAILURE TO FOLLOW SAFETY WARNINGS EXACTLY COULD RESULT IN DANGEROUS OPERATION, SERIOUS INJURY, DEATH OR PROPERTY DAMAGE.

IMPROPER SERVICING COULD RESULT IN DANGEROUS OPERATION, SERIOUS INJURY, DEATH OR PROPERTY DAMAGE.

- BEFORE SERVICING, DISCONNECT ALL ELECTRICAL POWER TO FURNACE.
- WHEN SERVICING CONTROLS, LABEL ALL WIRES PRIOR TO DISCONNECTING. RECONNECT WIRES CORRECTLY.
- VERIFY PROPER OPERATION AFTER SERVICING.



WARNING

HIGH VOLTAGE!

DISCONNECT ALL POWER BEFORE SERVICING OR INSTALLING THIS UNIT. MULTIPLE POWER SOURCES MAY BE PRESENT. FAILURE TO DO SO MAY CAUSE PROPERTY DAMAGE, PERSONAL INJURY OR DEATH.



WARNING

TO PREVENT PERSONAL INJURY OR DEATH DUE TO IMPROPER INSTALLATION, ADJUSTMENT, ALTERATION, SERVICE OR MAINTENANCE, REFER TO THIS MANUAL. FOR ADDITIONAL ASSISTANCE OR INFORMATION, CONSULT A QUALIFIED INSTALLER, SERVICER AGENCY OR THE GAS SUPPLIER.



CAUTION

SHEET METAL PARTS, SCREWS, CLIPS AND SIMILAR ITEMS INHERENTLY HAVE SHARP EDGES, AND IT IS NECESSARY THAT THE INSTALLER AND SERVICE PERSONNEL EXERCISE CAUTION.

Preventive maintenance is the best way to avoid unnecessary expense and inconvenience. Have this system inspected at regular intervals by qualified service personnel, at least twice a year. Routine maintenance should cover the following items:

1. Tighten all belts, set screws, and wire connections.
2. Clean evaporator and condenser coils mechanically or with cold water, if necessary. Usually any fouling is only matted on the entering air face of the coil and can be removed by brushing.

3. Lubricate motor bearings.
4. Align or replace belts as needed.
5. Replace filters as needed (see Filters section).
6. Check for blockage of condensate drain.
7. Check power and control voltages.
8. Check running amperage.
9. Check operating temperatures and pressures.
10. Check and adjust temperature and pressure controls.
11. Check and adjust damper linkages.
12. Check operation of all safety controls.
13. Check condenser fans and tighten set screws.

FILTERS



CAUTION

TO PREVENT PROPERTY DAMAGE DUE TO FIRE AND LOSS OF EQUIPMENT EFFICIENCY OR EQUIPMENT DAMAGE DUE TO DUST AND LINT BUILD UP ON INTERNAL PARTS, NEVER OPERATE UNIT WITHOUT AN AIR FILTER INSTALLED IN THE RETURN AIR SYSTEM.

Every application may require a different frequency of replacement of dirty filters. Filters must be replaced at least every three (3) months during operating seasons.

Dirty filters are the most common cause of inadequate heating or cooling performance. Filter inspection should be made at least every two months; more often if necessary because of local conditions and usage.

Dirty throwaway filters should be discarded and replaced with a new, clean filter.

Disposable return air filters are supplied with this unit. See the unit Specification Sheet or Technical Manual for the correct size and part number. To remove the filters, remove the filter access panel on return side of the unit.

CABINET FINISH MAINTENANCE

Use a fine grade automotive wax on the cabinet finish to maintain the finish's original high luster. This is especially important in installations with extended periods of direct sunlight.

CLEAN OUTSIDE COIL (QUALIFIED SERVICER ONLY)

The coil with the outside air flowing over it should be inspected annually and cleaned as frequently as necessary to keep the finned areas free of lint, hair and debris.

SCHEDULED MAINTENANCE

CONDENSER AND INDUCED DRAFT MOTORS

Bearings on the condenser fan motors and the combustion fan motor are permanently lubricated. No additional oiling is required.

LUBRICATION

The fan shaft bearings, the supply fan motors, the condenser fan motors and compressors are permanently lubricated.

FUNCTIONAL PARTS

Refer to the unit Parts Catalog for a list of functional parts. Parts are available from your distributor.

MCHX CARE

LUBRICATION

The fan shaft bearings, the supply fan motors, the condenser fan motors and compressors are permanently lubricated.

CLEAN OUTSIDE COIL (QUALIFIED SERVICER ONLY)

The coil with the outside air flowing over it should be inspected annually and cleaned as frequently as necessary to keep the finned areas free of lint, hair and debris.

MAINTENANCE OF MICROCHANNEL HEAT EXCHANGERS (MCHE)

Frequent servicing is essential to maintaining the required MCHE performance. For every installed Danfoss MCHE, service records must be documented.



CAUTION

PRIOR TO SERVICING MCHE, BE SURE TO DISCONNECT THE POWER SUPPLY AND USE LOCK-OUT METHODS TO PREVENT THE POWER FROM ACCIDENTALLY BEING TURNED ON.

SHUT DOWN PERIODS

During periods when the MCHE is not operated for longer than a week, the MCHE must be completely cleaned following the cleaning procedure. This practice must also be performed during short shut-down periods where corrosive deposits accumulate on the MCHE.

CLEANING PROCEDURE

Relative to tube & fin heat exchangers, MicroChannel heat exchanger coils tend to accumulate more dirt on the surface of the coil and less dirt inside the coil, making them

easier to clean. Follow the steps below for proper cleaning:

STEP 1: REMOVE SURFACE DEBRIS

Remove surface dirt, leaves, fibers, etc. with a vacuum cleaner (preferably with a brush or other soft attachment rather than a metal tube), compressed air blown from the inside out, and/or a soft bristle (not wire!) brush. Do not impact or scrape the coil with the vacuum tube, air nozzle, etc.

STEP 2: RINSE

Rinse the coil by following procedure:

1. Rinse the coil by approved MCHE cleaner first, or rinsing by water directly;
2. Waiting for 5 minutes;
3. Wash the coil by water;

Adjust the angle of gimbaled nozzle and insert it through fans. Using an extension rod if the nozzle cannot reach the bottom side. Preferably cleaning the coils from the inside-out and top to bottom (see figure 1), running the water through every fin passage until it comes out clean. The fins of MicroChannel coils are stronger than traditional tube & fin coil fins but still need to be handled with care. Do not hit the coil with the hose. We recommend placing your thumb over the end of the hose to obtain a gentler spray and reduce the possibility of impact damage. Please **PAY MORE ATTENTION** when using a pressure cleaning equipment to prevent damage.

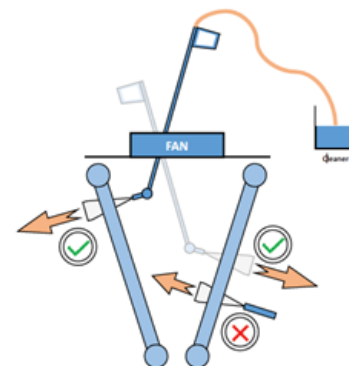

FIGURE 1

Highest pressure of cleaning equipment shall not exceed 15 bar, and tentatively move the cleaning equipment from far to near to prevent damage.

- KEEP the outlet of washer away from coil for at least 4in (see figure 2);
- KEEP the water gun perpendicular to the coil surface and the angle error shall less than 20°, or $\pm 40^\circ$ if the distance from washer to coil is more than 12in (see figure 2);

SCHEDULED MAINTENANCE

- Water outlet angle for high pressure cleaning equipment shall over 15° (see figure 3).

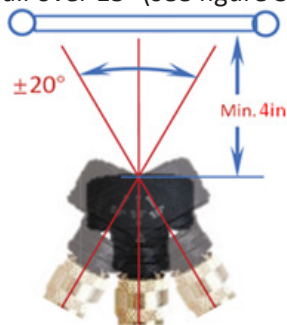

FIGURE 2



FIGURE 3

Warranty claims related to cleaning damage, especially for incorrect pressure washing operation, or corrosion resulting from applying non-recommended cleaners, will NOT be honored.

STEP 3: REMOVE SURFACE DEBRIS

Depending on the installation and fin geometry, MicroChannel heat exchangers could possibly retain more water compared to traditional tube & fin coils. It is advised to blow off or vacuum out the residual water from the coil to speed up drying and prevent pooling. Daikin recommends a quarterly cleaning of the coils, as the minimum. The cleaning frequency should be increased depending on the level of dirt/dust accumulation and the environment (e.g., coastal areas with chlorides and salts) or industrial areas with aggressive substances.



WARNING

FIELD APPLIED COATINGS ARE NOT RECOMMENDED FOR BRAZED ALUMINUM MICROCHANNEL HEAT EXCHANGERS. MICROCHANNEL HEAT EXCHANGERS MUST NOT BE COATED USING ANY OTHER COATING, COATING OF A COIL USING A SUPPLIER OR COATING PROCESS IS NOT APPROVED AND VOIDS THE PRODUCT WARRANTY. IT MAY ALSO REDUCE THE LIFETIME AND/OR THE PERFORMANCE OF THE MICROCHANNEL HEAT EXCHANGER.

INSPECTION & CLEANING

All flue product carrying areas of the furnace, its vent system, and main burners should be examined by a qualified service agency, and cleaned if necessary, before the start of each heating season. This examination is necessary for continued safe operation. Particular attention should be given to deterioration from corrosion or other sources. This examination is accomplished in the following manner.

1. Disconnect power to the unit and remove furnace section access panel.
2. Remove burner assembly:
 - A. Disconnect the wires from the gas valve after noting which wires are connected to each terminal.
 - B. Disconnect wires from the flame rod and ignition electrode.
 - C. Disconnect the gas piping at the union.
 - D. The entire burner assembly can now be removed from the unit.

NOTE: Use all screws that were removed; they are necessary for safe and proper operation of the unit.

3. Inspect and periodically clean the vent outlet (bird screen) on the access panel.

NOTE: Periodic observation of the flame and a log of CO₂ measurements are recommended. This will aid in determining whether the furnace is operating efficiently or if the furnace requires cleaning.

Flames should be stable, soft and blue (dust may cause orange tips but must not be yellow). The flames must extend directly outward from the burner without curling, floating or lifting off.

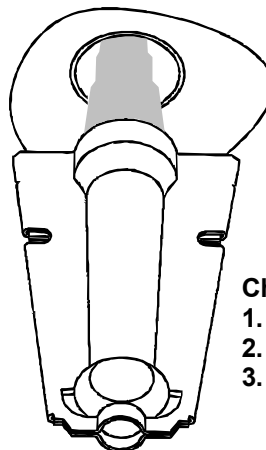

Check the burner flames for:

1. Good adjustment
2. Stable, soft and blue
3. Not curling, floating, or lifting off.

BURNER FLAME

SCHEDULED MAINTENANCE



WARNING

TO AVOID PERSONAL INJURY OR DEATH DUE TO ELECTRIC SHOCK, DO NOT REMOVE ANY INTERNAL COMPARTMENT COVERS OR ATTEMPT ANY ADJUSTMENT. CONTACT A QUALIFIED SERVICER AT ONCE IF AN ABNORMAL FLAME SHOULD DEVELOP.

At least once a year, prior to or during the heating season, make a visual check of the burner flames.

NOTE: This will involve removing and reinstalling the heat exchanger door on the unit, which is held by two screws. If you are uncertain about your ability to do this, contact a qualified servicer.

If a strong wind is blowing, it may alter the airflow pattern within the unit enough that an inspection of the burner flames is not possible.

FUNCTIONAL PARTS

Refer to the unit Parts Catalog for a list of functional parts. Parts are available from your distributor.

TROUBLESHOOTING

IGNITION CONTROL ERROR CODES

The following presents probable causes of questionable unit operation. Refer to *Diagnostic Indicator Chart* for an interpretation of the signal and to this section for an explanation.

Remove the control box access panel and note the number of diagnostic LED flashes.

INTERNAL CONTROL FAILURE

If the integrated ignition control in this unit encounters an internal fault, it will go into a “hard” lockout and turn off the diagnostic LED. If diagnostic LED indicates an internal fault, check power supply to unit for proper voltage, check all fuses, circuit breakers and wiring. Disconnect electric power for five seconds. If LED remains off after restoring power, replace control.